

# Cortical dynamics of three-dimensional form, color, and brightness perception: I. Monocular theory

STEPHEN GROSSBERG

*Boston University, Boston, Massachusetts*

A real-time visual processing theory is developed to explain how three-dimensional form, color, and brightness percepts are coherently synthesized. The theory describes how several fundamental uncertainty principles which limit the computation of visual information at individual processing stages are resolved through parallel and hierarchical interactions among several processing stages. The theory hereby provides a unified analysis and many predictions of data about stereopsis, binocular rivalry, hyperacuity, McCollough effect, textural grouping, border distinctness, surface perception, monocular and binocular brightness percepts, filling-in, metacontrast, transparency, figural aftereffects, lateral inhibition within spatial frequency channels, proximity-luminance covariance, tissue contrast, motion segmentation, and illusory figures, as well as about reciprocal interactions among the hypercolumns, blobs, and stripes of cortical areas V1, V2, and V4. Monocular and binocular interactions between a Boundary Contour (BC) System and a Feature Contour (FC) System are developed. The BC System, defined by a hierarchy of oriented interactions, synthesizes an emergent and coherent binocular boundary segmentation from combinations of unoriented and oriented scenic elements. These BC System interactions instantiate a new theory of stereopsis and of how mechanisms of stereopsis are related to mechanisms of boundary segmentation. Interactions between the BC System and the FC System explain why boundary completion and segmentation processes become binocular at an earlier processing stage than do color and brightness perception processes. The new stereopsis theory includes a new model of how chromatically broadband cortical complex cells can be adaptively tuned to multiplex information about position, orientation, spatial frequency, positional disparity, and orientational disparity. These binocular cells input to spatially short-range competitive interactions (within orientations and between positions, followed by between orientations and within positions) that initiate suppression of binocular double images as they complete boundaries at scenic line ends and corners. The competitive interactions interact via both feedforward and feedback pathways with spatially long-range-oriented cooperative gating interactions that generate a coherent, multiple-scale, three-dimensional boundary segmentation as they complete the suppression of double-image boundaries. The completed BC System boundary segmentation generates output signals, called filling-in generators (FIGs) and filling-in barriers (FIBs), along parallel pathways to two successive FC System stages: the monocular syncytium and the binocular syncytium. FIB signals at the monocular syncytium suppress monocular color and brightness signals that are binocularly inconsistent and select binocularly consistent, monocular FC signals as outputs to the binocular syncytium. Binocular matching of these FC signals further suppresses binocularly inconsistent color and brightness signals. Binocular FC contour signals that survive these multiple suppressive events interact with FIB signals at the binocular syncytium to fill-in a multiple-scale representation of form-and-color-in-depth. To achieve these properties, distinct syncytia correspond to each spatial scale of the BC System. Each syncytium is composed of opponent subsyncytia that generate output signals through a network of double-opponent cells. Although composed of unoriented wavelength-sensitive cells, double-opponent networks detect oriented properties of form when they interact with FIG signals, yet also generate nonselective properties of binocular rivalry. Electrotonic and chemical transmitter interactions within the syncytia are formally akin to interactions in H1 horizontal cells of turtle retina. The cortical syncytia are hypothesized to be encephalizations of ancestral retinal syncytia. In addition to double-opponent-cell networks, electrotonic syncytial interactions, and resistive gating signals due to BC System outputs, the FC System processes also include habituating transmitters and non-Hebbian adaptive filters that maintain the positional and chromatic selectivity of FC interactions. Alternative perceptual theories are evaluated in light of these results. The theoretical circuits provide qualitatively new design principles and architectures for computer vision applications.

---

This work was supported in part by grants from the Air Force Office of Scientific Research (AFOSR 85-0149 and AFOSR F49620-86-C-0037), the Army Research Office (ARO DAAG-29-85-K-0095), and the National Science Foundation (NSF IST-8417756). I thank Cynthia Suchta for her valuable assistance in the preparation of the manuscript and illustrations. The author's address is: Center for Adaptive Systems, Boston University, 111 Cummington Street, Boston, MA 02215.

## 1. Introduction

When we gaze upon a scene, our brains combine many types of locally ambiguous visual information to rapidly generate a globally unambiguous representation of form-and-color-in-depth. In contrast, many models of visual perception are specialized models that deal with only one type of information—for example, boundary, disparity, curvature, shading, color, or spatial-frequency information. For such models, other types of signals are often contaminants, or noise elements, rather than cooperative sources of ambiguity-reducing information. This state of affairs raises the basic question: What new principles and mechanisms are needed to understand how multiple sources of visual information preattentively cooperate to generate a percept of three-dimensional (3-D) form?

This pair of articles describes a single neural network architecture for 3-D form, color, and brightness perception. The model has been developed to analyze and predict behavioral and neural data about such diverse phenomena as boundary detection, sharpening, and completion; textural segmentation and grouping; surface perception, notably shape-from-shading; stereopsis; multiple-scale filtering; hyperacuity; filling-in of brightness and color; and perceptual aftereffects. The macrocircuit diagram to which these studies have led, and which is introduced and developed herein, is depicted in Figure 1.

This macrocircuit represents a synthesis of two parallel lines of theoretical inquiry. One line of theory focused upon problems concerning monocular brightness, color, and form perception (Cohen & Grossberg, 1984a; Grossberg, 1980, 1983a, 1983b, 1984, 1987a; Grossberg & Mingolla, 1985a, 1985b, 1986b, 1987). The other line of theory focused upon problems concerning binocular depth, brightness, and form perception (Cohen & Grossberg, 1984a, 1984b; Grossberg, 1981, 1983a, 1983b, 1987a). Each theory used its new behavioral and neural concepts and mechanisms to qualitatively explain and to quantitatively simulate on the computer large, but distinct, classes of perceptual and neural data. The present theory builds upon the concepts of these previous theories to generate a unified monocular and binocular theory with a far-reaching explanatory and predictive range.

## 2. The Heterarchical Resolution of Uncertainty

The previous and present theories begin with an analysis of the sensory uptake process. Such an analysis shows that there exist fundamental limitations of the visual measurement process at each stage of neural processing. The theory shows how the nervous system *as a whole* can compensate for these uncertainties using both parallel and hierarchical stages of neural processing. Thus, the visual nervous system is designed to achieve *heterarchical compensation for uncertainties of measurement*.

I suggest that many of the subtleties in understanding the visual system derive from the following general fact: When a neural processing stage eliminates one type of uncertainty in the input patterns that it receives, it often generates a new type of uncertainty in the outputs that

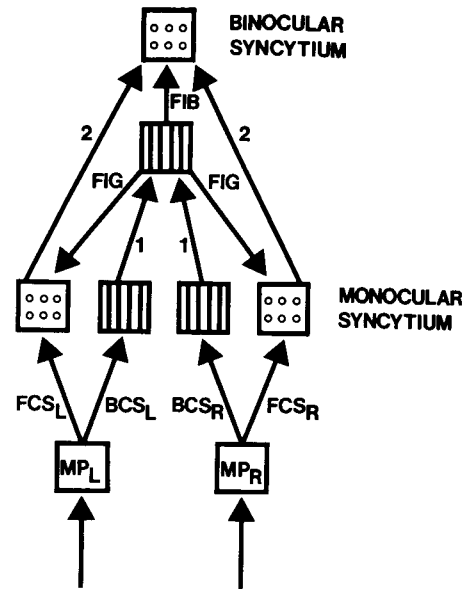

Figure 1. Macrocircuit of monocular and binocular interactions within the Boundary Contour System (BCS) and the Feature Contour System (FCS): Left and right monocular preprocessing stages ( $MP_L$  and  $MP_R$ ) send parallel monocular inputs to the BCS (boxes with vertical lines) and the FCS (boxes with three pairs of circles). The monocular  $BCS_L$  and  $BCS_R$  interact via bottom-up pathways labeled 1 to generate a coherent binocular boundary segmentation. This segmentation generates output signals called filling-in generators (FIGs) and filling-in barriers (FIBs). The FIGs input to the monocular syncytia of the FCS. The FIBs input to the binocular syncytia of the FCS. The text describes how inputs from the MP stages interact with FIGs at the monocular syncytia to selectively generate binocularly consistent feature-contour signals along the pathways labeled 2 to the binocular syncytia. Grossberg (1987b) describes how these monocular feature-contour signals interact with FIB signals to generate a multiple-scale representation of form-and-color-in-depth within the binocular syncytia.

it passes along to the next processing stage. Uncertainties beget uncertainties. Informational uncertainty is not progressively reduced by every stage of neural processing. This striking property of neural information processing invites comparisons with fields other than visual perception and neurobiology, such as quantum statistical mechanics, the foundations of geometry, and artificial intelligence.

The identification of several new uncertainty principles that visual interactions are designed to surmount has led to qualitatively new computational theory of how visual systems are designed. Although Figure 1 contains a number of distinct macrostages, the microscopic circuit designs that comprise each macrostage take on functional meaning only in terms of the circuit designs within other macrostages. In earlier work, for example, rules for monocular boundary segmentation and featural filling-in were discovered through an analysis of how each type of process interacts with, and complements deficiencies of, the other. The present work became possible when it was noticed that these rules for monocular boundary segmentation and filling-in also provided a basis for analyzing

stereopsis and the suppression of binocular double images. Such results suggest that the popular hypothesis of independent modules in visual perception is both wrong and misleading. Specialization exists, to be sure, but its functional significance is not captured by the concept of independent modules.

### 3. The Boundary Contour System and the Feature Contour System

The present pair of articles specifies both the functional meaning and the mechanistic interactions of the model microcircuits that comprise the macrocircuit schematized in Figure 1. This macrocircuit is built up from two systems, the Boundary Contour (BC) System and the Feature Contour (FC) System. Previous articles have developed rules for these systems in a monocular setting. The present pair of articles shows that and how these rules can be generalized to explain both monocular and binocular data.

The BC System controls the emergence of a 3-D segmentation of a scene. This segmentation process is capable of detecting, sharpening, and completing boundaries; of grouping textures; of generating a boundary web of form-sensitive compartments in response to smoothly shaded regions; and of carrying out a disparity-sensitive and scale-sensitive binocular matching process. The outcome of this 3-D segmentation process is perceptually invisible within the BC System. Visible percepts are a property of the FC System.

A completed segmentation within the BC System elicits topographically organized output signals to the FC System. These completed BC Signals regulate the hierarchical processing of color and brightness signals by the FC System (Figure 1). Notable among FC System processes are the extraction of color and brightness signals that are relatively uncontaminated by changes in illumination conditions. These FC signals interact within the FC System with the output signals from the BC System to control featural filling-in processes. These filling-in processes lead to visible percepts of color-and-form-in depth at the final stage of the FC System, which is called the binocular syncretium (Figure 1).

In order to achieve a self-contained presentation, the basic monocular properties of the BC System and the FC System will be reviewed before they are used to explain more data and as a foundation for developing a binocular theory.

### 4. Preattentive versus Postattentive Color-Form Interactions

The processes summarized in Figure 1 are preattentive and automatic. These preattentive processes may, however, influence and be influenced by attentive, learned object-recognition processes. The macrocircuit depicted in Figure 2 suggests, for example, that a preattentively completed segmentation within the BC System can directly activate an Object Recognition System (ORS), whether or not this segmentation supports visible contrast differences within the FC System. The ORS can, in turn, read

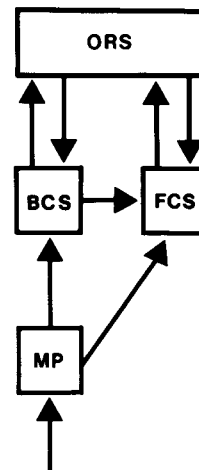

Figure 2. A macrocircuit of processing stages: Monocular preprocessed signals (MP) are sent independently to both the Boundary Contour System (BCS) and the Feature Contour System (FCS). The BCS preattentively generates coherent boundary structures from these MP signals. These structures send outputs to both the FCS and the Object Recognition System (ORS). The ORS, in turn, rapidly sends top-down learned template signals to the BCS. These template signals can modify the preattentively completed boundary structures using learned information. The BCS passes these modifications along to the FCS. The signals from the BCS organize the FCS into perceptual regions wherein filling-in of visible brightnesses and colors can occur. This filling-in process is activated by signals from the MP stage. The completed FCS representation, in turn, also interacts with the ORS.

out attentive learned priming, or expectation, signals to the BC System. In response to familiar objects in a scene, the final 3-D segmentation within the BC System may thus be doubly completed, first by automatic preattentive segmentation processes and then by attentive learned expectation processes. This doubly completed segmentation regulates the filling-in processes within the FC System that lead to a percept of visible form. The FC System also interacts with the ORS. The rules whereby such parallel inputs from the BC System and the FC System are combined within the ORS have been the subject of active experimental investigation (Garner, 1974; Pomerantz, 1981, 1983; Pomerantz & Schweitzerberg, 1975; Stefurak & Boynton, 1986; Treisman, 1982; Treisman & Gelade, 1980; Treisman & Schmidt, 1982; Treisman, Sykes, & Gelade, 1977).

The present theory hereby clarifies two distinct types of interactions that may occur among processes governing segmentation and color perception: preattentive interactions from the BC System to the FC System (Figure 1) and attentive interactions between the BC System and the ORS and the FC System and the ORS (Figure 2). In support of this distinction, Houck and Hoffman (1986) have described McCollough aftereffects that were independent of whether the adaptation stimuli were presented inside or outside the focus of spatial attention. Grossberg (1987b—Part II of the present pair of articles) suggests an explanation of McCollough aftereffects in

terms of interactions of the BC System with the FC System. This explanation clarifies the data of Houck and Hoffman (1986), showing that McCollough aftereffects may be preattentively generated, but also notes the possibility that modulatory effects may sometimes occur via the attentionally controlled pathway ORS → BC System → FC System (Figure 2). For recent analyses of such attentive top-down priming effects, see Carpenter and Grossberg (1986, 1987) and Grossberg and Stone (1986).

The remainder of the articles develop the model mechanisms whereby the BC System and the FC System preattentively interact. The present article provides a self-contained review of the monocular theory and uses it to analyze results from a number of perceptual and neural experiments that were not discussed in Cohen and Grossberg (1984a) or Grossberg and Mingolla (1985a, 1985b, 1987). Since several of these experiments were performed after the monocular theory was published, they illustrate the theory's predictive competence. Grossberg (1987b—Part II of the present pair of articles) uses this foundation to derive the theory's binocular mechanisms, which are then applied to the analysis of both binocular phenomena and monocular phenomena that engage binocular mechanisms.

### 5. Discounting the Illuminant: Extracting Feature Contours

One form of uncertainty with which the nervous system deals is due to the fact that the visual world is viewed under variable lighting conditions. When an object reflects light to an observer's eyes, the amount of light energy within a given wavelength that reaches the eye from each object location is determined by a product of two factors. One factor is a fixed ratio, or reflectance, which determines the fraction of incident light that is reflected by that object location to the eye. The other factor is the variable intensity of the light which illuminates the object location. Two object locations with equal reflectances can reflect different amounts of light to the eye if they are illuminated by different light intensities. Spatial gradients of light across a scene are the rule, rather than the exception, during perception, and wavelengths of light that illuminate a scene can vary widely during a single day. If the nervous system directly coded into percepts the light energies which it received, it would compute false measures of object colors and brightnesses, as well as false measures of object shapes. This problem was already clear to Helmholtz (1909/1962). It demands an approach to visual perception that points away from a simple Newtonian analysis of colors and white light.

Land (1977) and his colleagues have sharpened contemporary understanding of this issue by carrying out a series of remarkable experiments. In these experiments, a picture constructed from overlapping patches of colored paper, called a McCann Mondrian, is viewed under different lighting conditions. If red, green, and blue lights

simultaneously illuminate the picture, then an observer perceives surprisingly little color change as the intensities of illumination are chosen to vary within wide limits. The stability of perceived colors obtains despite the fact that the intensity of light at each wavelength that is reflected to the eye varies linearly with the incident illumination intensity at that wavelength. This property of color stability indicates that the nervous system "discounts the illuminant," or suppresses the "extra" amount of light in each wavelength, in order to extract a color percept that is invariant under many lighting conditions.

In an even more striking experimental demonstration of this property, inhomogeneous lighting conditions were devised such that spectrophotometric readings from positions within the interiors of two color patches were the same, yet the two patches appeared to have different colors. The perceived colors were, moreover, close to the colors that would be perceived when viewed in a homogeneous source of white light.

These results show that the signals from within the interiors of the colored patches are significantly attenuated in order to discount the illuminant. This property makes ecological sense, since even a gradual change in illumination level could cause a large cumulative distortion in perceived color or brightness if it were allowed to influence the percept of a large scenic region. In contrast, illuminant intensities typically do not vary much across a scenic edge. Thus the ratio of light signals reflected from the two sides of a scenic edge can provide an accurate local estimate of the relative reflectances of the scene at the corresponding positions. We have called the color and brightness signals that remain unattenuated near scenic edges FC signals.

The neural mechanisms that "discount the illuminant" overcome a fundamental uncertainty in the retinal pickup of visual information. In so doing, however, they create a new problem of uncertain measurement, which illustrates one of the classical uncertainty principles of visual perception. If color and brightness signals are suppressed except near scenic edges, then why do we not see just a world of colored edges? How are these local FC signals used by later processing stages to synthesize global percepts of continuous forms, notably of color fields and of smoothly varying surfaces?

Land (1977, 1983) developed his Retinex model to formally show how FC signals could be combined to generate veridical color and brightness percepts within the patches of McCann Mondrians. Although his model was an important step forward that showed the sufficiency of using FC signals to build up a color or brightness percept in response to McCann Mondrians, its operations do not translate directly into a neurally plausible model, and it cannot explain many brightness and color percepts outside the domain of McCann Mondrians (Grossberg & Mingolla, 1985a, 1985b). An important task of perceptual theory is thus to explain why the Retinex model works so well on McCann Mondrians, but fails in general.

## 6. Featural Filling-In and Stabilized Images

Our monocular theory has developed mechanisms whereby contour-sensitive FC signals activate a process of lateral spreading, or filling-in, of color and brightness signals within the FC System. This filling-in process is contained by topographically organized output signals from the BC System to the FC System (Figure 1). Where no BC signals obstruct the filling-in process, its strength is attenuated with distance. Our monocular model for this filling-in process was developed and tested using quantitative computer simulations of paradoxical brightness data (Cohen & Grossberg, 1984a).

Many examples of featural filling-in and its containment by BC signals can be cited. A classical example of this phenomenon is described in Figure 3. The image in Figure 3 was used by Yarbus (1967) in a stabilized-image experiment. Normally, the eye jitters rapidly in its orbit, and thereby is in continual relative motion with respect to a scene. In a stabilized-image experiment, prescribed regions in an image are kept stabilized, or do not move with respect to the retina. Stabilization is accomplished by the use of a contact lens or an electronic feedback circuit. Stabilizing an image with respect to the retina can cause the perception of the image to fade (Krauskopf, 1963; Pritchard, 1961; Pritchard, Heron, & Hebb, 1960; Riggs, Ratliff, Cornsweet, & Cornsweet, 1953; Yarbus, 1967). The adaptive utility of this property can be partially understood by noting that, in humans, light passes through retinal veins before it reaches the photosensitive retina. The veins form stabilized images with respect to

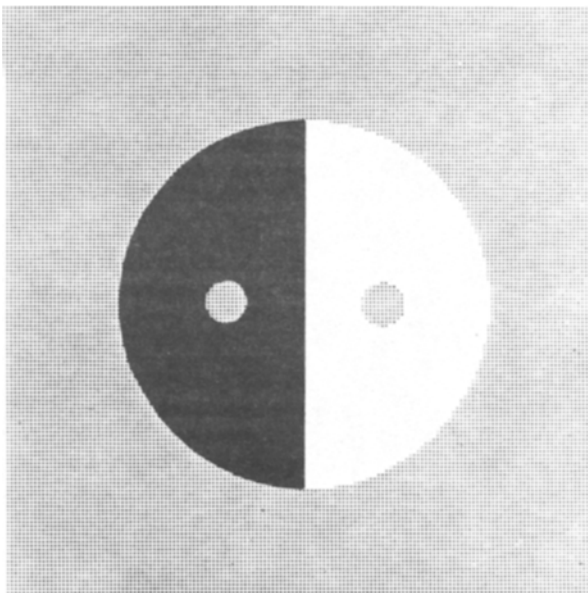

Figure 3. A classical example of featural filling-in: When the edges of the large circle and the vertical line are stabilized on the retina, the red color (dots) outside the large circle envelopes the black and white hemidisks except within the small red circles whose edges are not stabilized (Yarbus, 1967). The red inside the left circle looks brighter and the red inside the right circle looks darker than the enveloping red.

the retina, hence are fortunately not visible under ordinary viewing conditions.

In the Yarbus display shown in Figure 3, the large circular edge and the vertical edge are stabilized with respect to the retina. As these edge percepts fade, the red color outside the large circle is perceived to flow over and envelop the black and white hemidisks until it reaches the small red circles whose edges are not stabilized. This percept illustrates how FC signals can spread across, or fill-in, a scenic percept until they hit perceptually significant boundaries.

In summary, the uncertainty of variable lighting conditions is resolved by discounting the illuminant and extracting contour-sensitive FC signals. The uncertainty created within the discounted regions is resolved at a later processing stage via a featural filling-in process that is activated by the FC signals.

## 7. Neon Color Flanks and Neon Color Spreading

Filling-in of color and brightness can be seen without using stabilized-image techniques. The theory suggests explanations of many such filling-in reactions through its analyses of how emergent segmentations within the BC System can inhibit some BC signals that would otherwise be activated by local scenic contrasts. When these segmentations generate BC signals to the FC System, the inhibited boundary segments cannot contain the flow of color or brightness across their positions. Then color or brightness can flow out of regions that contain all of their inducing FC signals. The flow of color or brightness tends to fill-in whatever FC region is bounded by a compartment of the segmentation, subject to the attenuation of filling-in with distance. Such a filled-in percept thus provides visible evidence of how BC signals can both compete and cooperate to form an emergent segmentation whose topographically organized output signals to the FC System define the compartments that contain the featural filling-in process.

Using such analyses, the theory suggests explanations (Grossberg & Mingolla, 1985a, 1985b, 1987) of many properties of neon color flanks and neon color spreading (Ejima, Redies, Takahashi, & Akita, 1984; Redies & Spillmann, 1981; Redies, Spillmann, & Kunz, 1984; van Tuijl, 1975; van Tuijl & de Weert, 1979; van Tuijl & Leeuwenberg, 1979). For example, when a suitably sized and contrastive red cross is placed within a black Ehrenstein figure, as in Figure 4a, the redness is perceived to fill-in the emergent boundary, or illusory figure, generated by the Ehrenstein figure. When a suitably sized and contrastive horizontal red line segment is placed colinear to flanking horizontal black line segments, as in Figure 4b, then color fills in approximately colinear neon flanks. When several such horizontal red line segments are arranged so that their line ends are aligned, as in Figure 4c, then color fills in the vertical region that bounds these horizontal red line segments.

Thus, an emergent segmentation can generate a colinear grouping, as in Figure 4b, a perpendicular grouping, as

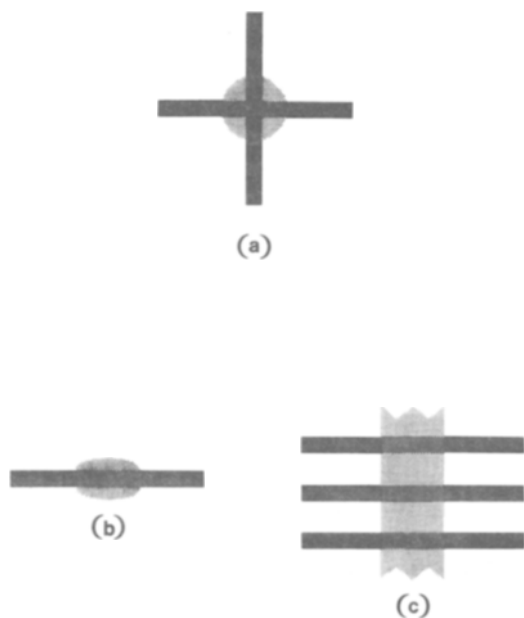

**Figure 4.** Neon color flanks and spreading: (a) When a colored cross is surrounded by an Ehrenstein figure, the red color can flow out of the cross until it hits the illusory boundary induced by the Ehrenstein figure. (b) When a colored line spans a gap in a black line, the spread of neon color is confined to a narrow diffuse streak that flanks the colored line on either side. (c) When several such colored lines are arranged along a smooth path, then the neon flanks are replaced by a wide band of neon color. The stippled areas schematize the regions in which neon is seen.

in Figures 4a and 4c, or even a diagonal grouping, as occurs if the image in Figure 4a is periodically repeated (Redies & Spillmann, 1981). In every case, certain BC signals, which are perpendicular to, or at least noncolinear with, the direction of the strongest cooperative groupings at chromatic-achromatic boundaries, are inhibited. Neon color phenomena thus provide visible evidence of *oriented* cooperative-competitive interactions within the BC System. In contrast, the fact that color or brightness can fill in whatever compartments may emerge illustrates that featural filling-in within the FC System is an unoriented process, unlike the segmentation process that contains it. This is one of the rule differences that may be used to distinguish the BC System from the FC System.

### 8. The Boundary Contour System and the Feature Contour System Obey Different Rules

Figure 5 provides another type of evidence that FC and BC information is extracted by separate, but parallel, neural subsystems before being integrated at a later stage into a unitary percept. The total body of evidence for this new insight takes several forms: the two subsystems obey different rules; they can be used to explain a large body of perceptual data that has received no other unified explanation; they can be perceptually dissociated; when they are interpreted in terms of different neural substrates (the cytochrome-oxidase staining blob system and the hypercolumn system of the striate cortex and their prestriate

cortical projections), their rules are consistent with known cortical data and have successfully predicted new cortical data (Grossberg, 1984; Grossberg & Mingolla, 1985a).

Figure 5 illustrates several more rule differences between the BC System and the FC System. The reproduction process may have weakened the percept of an "illusory" square. The critical percept is that of the square's vertical boundaries. The black-gray vertical edge of the top-left Pac-man figure is, relatively speaking, a dark-light vertical edge. The white-gray vertical edge of the bottom-left Pac-man figure is, relatively speaking, a light-dark vertical edge. These two vertical edges possess the same orientation but opposite directions-of-contrast. The percept of the vertical boundary that spans these opposite direction-of-contrast edges shows that the BC System is sensitive to boundary orientation but is indifferent to direction-of-contrast. This observation is strengthened by the fact that the horizontal boundaries of the square, which connect edges of like direction-of-contrast, group together with the vertical boundaries to generate a unitary percept of a square. Opposite direction-of-contrast and same direction-of-contrast boundaries both input to the same BC System.

The FC System must, by contrast, be exquisitely sensitive to direction-of-contrast. If FC signals were insensitive to direction-of-contrast, then it would be impossible to detect which side of a scenic edge possessed a larger reflectance, as in dark-light and red-green discriminations. Thus, the rules obeyed by the two contour-extracting systems are not the same.

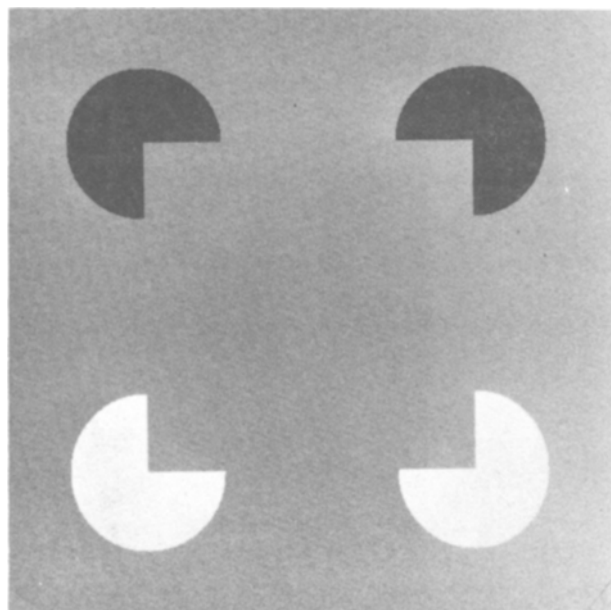

**Figure 5.** A reverse-contrast Kanizsa square: An illusory square is induced by two black and two white Pac-man figures on a gray background. Illusory contours can thus join edges with opposite directions of contrast. (This effect may be weakened by the photographic reproduction process.)

The BC System and the FC System differ in their spatial interaction rules in addition to their rules of contrast. For example, in Figure 5, a vertical illusory boundary forms between the BCs generated by a pair of vertically oriented and spatially aligned Pac-man edges. Thus, the process of boundary completion is due to an *inwardly* directed and *oriented* interaction, whereby *pairs* of inducing BC signals can trigger the formation of an intervening boundary of similar orientation. In contrast, in the filling-in reactions of Figures 3 and 4, featural quality can flow from each FC signal in all directions until it hits a BC or is attenuated by its own spatial spread. Thus, featural filling-in is an *outwardly* directed and *unoriented* interaction that is triggered by *individual* FC signals. The manner in which the FC System can achieve both sensitivity to direction-of-contrast and unoriented filling-in is clarified in Section 24.

### 9. Illusory Percepts as Probes of Adaptive Processes

The adaptive value of a featural filling-in process is clarified by considering how the nervous system discounts the illuminant. The adaptive value of a boundary completion process with properties capable of generating the percept of a Kanizsa square (Figure 5) can be understood by considering other imperfections of the retinal uptake process. For example, as noted in Section 5, light passes through retinal veins before it reaches retinal photoreceptors. Human observers do not perceive their retinal veins in part due to the action of mechanisms that attenuate the perception of images that are stabilized with respect to the retina. Mechanisms capable of generating this adaptive property of visual percepts can also generate paradoxical percepts, as during the perception of stabilized images or ganzfelds (Pritchard, 1961; Pritchard et al., 1960; Riggs et al., 1953; Yarbus, 1967), including the percept of Figure 3.

Suppressing the perception of stabilized veins is insufficient to generate an adequate percept. The images that reach the retina can be occluded and segmented by the veins in several places. Somehow, broken retinal contours need to be completed and occluded retinal color and brightness signals need to be filled-in. Holes in the retina, such as the blind spot or certain scotomas, are also not visually perceived (Gerrits, de Haan, & Vendrick, 1966; Gerrits & Timmerman, 1969; Gerrits & Vendrick, 1970) due to a combination of boundary completion and filling-in processes (Kawabata, 1984). These completed boundaries and filled-in colors are illusory percepts, albeit illusory percepts with an important adaptive value. Observers are not aware which parts of such a completed figure are "real" (derived directly from retinal signals) or "illusory" (derived by boundary completion and featural filling-in). Thus, in a perceptual theory capable of understanding such completion phenomena, "real" and "illusory" percepts exist on an equal ontological footing. Consequently, we have been able to use the large literature on illusory figures, such as Figure 5, and filling-in reactions, such as Figures 3 and 4, to help us discover

the distinct rules of BC System segmentation and FC System filling-in (Arend, Buehler, & Lockhead, 1971; Day, 1983; Gellatly, 1980; Kanizsa, 1974; Kennedy, 1978, 1979, 1981; Parks, 1980; Parks & Marks, 1983; Petry, Harbeck, Conway, & Levey, 1983; Redies & Spillmann, 1981; van Tuijl, 1975; van Tuijl & de Weert, 1979; Yarbus, 1967).

### 10. Boundary Contour Detection and Grouping Begins with Oriented Receptive Fields

Having distinguished the BC System from the FC System, I now more closely scrutinize the rules whereby boundaries are synthesized. This analysis leads to two of the theory's most important conclusions concerning how the visual system solves problems of uncertain measurement.

In order to build up boundaries effectively, the BC System must be able to determine the orientation of a boundary at every position. To accomplish this, the cells at the first stage of the BC System possess orientationally tuned receptive fields, or oriented masks. Such a cell, or cell population, is selectively responsive to oriented contrasts that activate a prescribed small region of the retina, and whose orientations lie within a prescribed band of orientations with respect to the retina. A collection of such orientationally tuned cells is assumed to exist at every network position, such that each cell type is sensitive to a different band of oriented contrasts within its prescribed small region of the scene, as in the hypercolumn model of Hubel and Wiesel (1977).

These oriented receptive fields illustrate that, from the very earliest stages of BC System processing, image contrasts are grouped and regrouped in order to generate configurations of ever greater global coherence and structural invariance. For example, even the oriented masks at the earliest stage of BC System processing regroup image contrasts (Figure 6). Such masks are oriented *local contrast* detectors, rather than edge detectors. This property enables them to fire in response to a wide variety of spatially nonuniform image contrasts that do not contain edges, as well as in response to edges. In particular, such oriented masks can respond to spatially nonuniform densities of unoriented textural elements, such as dots. They can also respond to spatially nonuniform densities of surface gradients. Thus, by sacrificing a certain amount of spatial resolution in order to detect oriented local contrasts, these masks achieve a general detection characteristic which can respond to boundaries, textures, and surfaces.

The fact that these receptive fields are *oriented* greatly reduces the number of possible groupings into which their target cells can enter. On the other hand, in order to detect oriented local contrasts, the receptive fields must be elongated along their preferred axis of symmetry. Then the cells can preferentially detect differences of average contrast across this axis of symmetry, yet can remain silent in response to differences of average contrast that are perpendicular to the axis of symmetry. Such receptive-field elongation creates even greater positional uncertainty

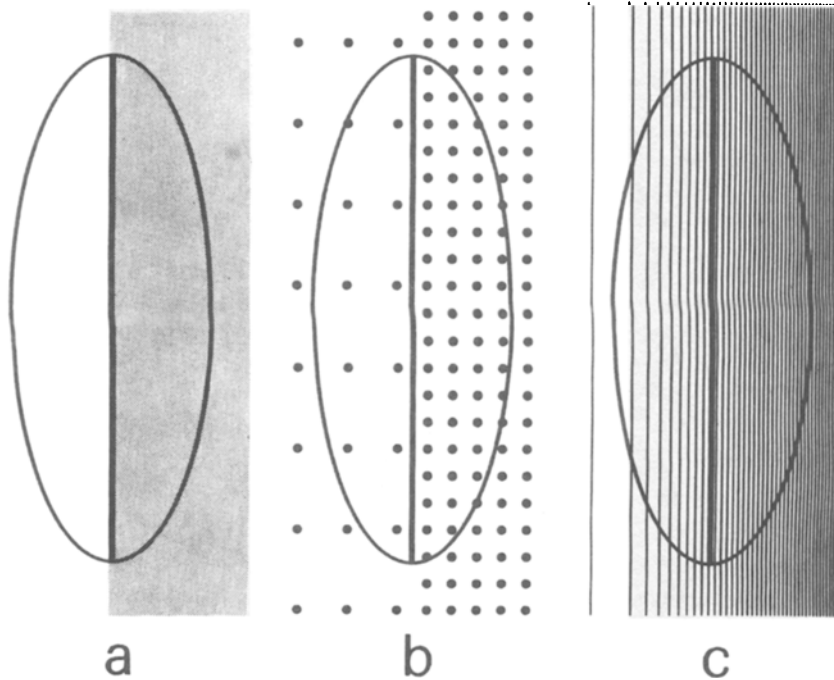

Figure 6. Oriented masks respond to amount of luminance contrast over their elongated axis of symmetry, regardless of whether image contrasts are generated by (a) luminance step functions, (b) differences in textural distribution, or (c) smooth luminance gradients (indicated by the spacings of the lines).

about the exact locations within the receptive field of the image contrasts that fire the cell. This positional uncertainty becomes acute during the processing of image line ends and corners.

### 11. A Basic Uncertainty Principle: Orientational Certainty Implies Positional Uncertainty at Line Ends and Corners

Oriented receptive fields cannot easily detect the ends of thin scenic lines or scenic corners. This positional uncertainty is illustrated by the computer simulation in Figure 7. The scenic image is a black vertical line (colored gray for illustrative purposes) against a white background. The line is drawn large to represent its scale relative to the receptive fields that it activates. The activation level of each oriented receptive field at a given position is proportional to the length of the line segment at that position which possesses the same orientation as the corresponding receptive field. The relative lengths of line segments across all positions encode the relative levels of receptive-field activation due to different parts of the input pattern. We call such a spatial array of oriented responses an *orientation field*. An orientation field provides a concise statistical description of an image as seen by the receptive fields that it can activate.

In Figure 7, a strong vertical reaction occurs at positions along the vertical sides of the input pattern that are sufficiently far from the bottom of the pattern. The contrast needed to activate these receptive fields was chosen to be low enough to allow cells with close-to-vertical

orientations to be significantly activated at these positions. Despite the fact that cells were tuned to respond to relatively low contrasts, the cell responses at positions near the end of the line are very small. Figure 7 thus illustrates a basic uncertainty principle that says: Orientational “certainty” implies positional “uncertainty” at the ends of scenic lines.

Why does the nervous system not overcome this difficulty by restricting itself to perceiving objects that are wide enough to offset the positional uncertainty depicted in Figure 7? This could be done only at the cost of a large loss of acuity, since only object dimensions that are wider than the elongated receptive fields could then be perceived. Were such a restriction enforced, the nervous system would have to somehow prevent the processing of the long edges of scenic lines and curves, which are well within receptive field capabilities, as in Figure 7, whenever the ends of the lines were too thin. Since scenic lines and curves can be arranged in very complex configurations, such a restriction could not be implemented without an extremely complex interaction scheme. Alternatively, one might ask why the nervous system bothers at all to offset the positional uncertainty at line ends and corners. The next section shows that a perceptual disaster would ensue in the absence of such compensation.

Thus, a strong selective pressure exists toward the design of visual systems possessing a discriminative capability finer than that of their individual receptive fields. Such *hyperacuity* is, of course, well known to exist (Badcock & Westheimer, 1985a, 1985b; Beck & Schwartz,



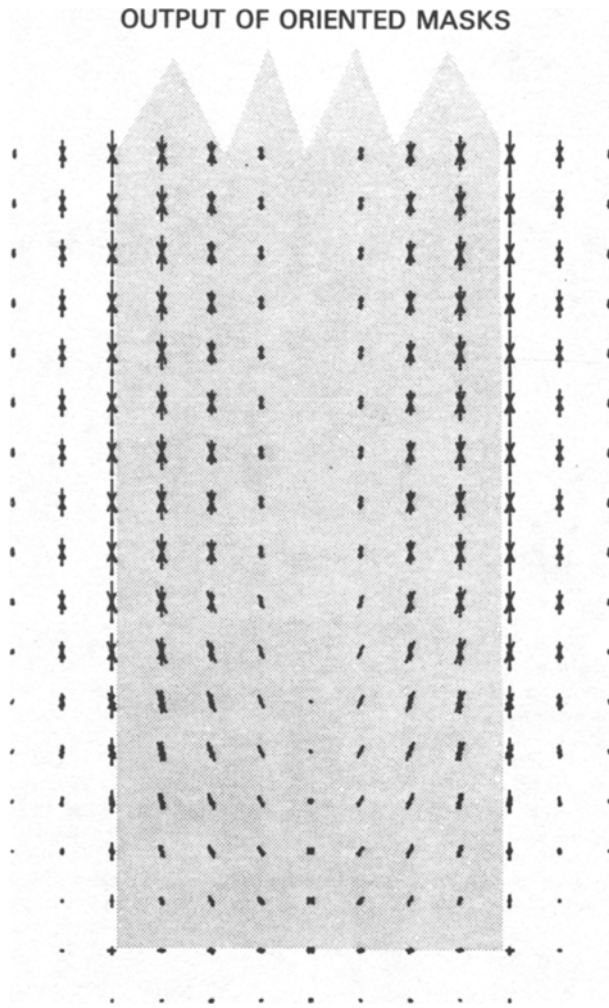

Figure 7. An orientation field: Lengths and orientations of lines encode the relative sizes of the activations and orientations of the input masks at the corresponding positions. The input pattern, which is a vertical line end as seen by the receptive fields, corresponds to the shaded area. Each mask has total exterior dimension of  $16 \times 8$  units, with a unit length being the distance between two adjacent lattice positions. Reprinted from "Neural Dynamics of Perceptual Grouping: Textures, Boundaries, and Emergent Segmentations" by S. Grossberg and E. Mingolla, 1985, *Perception & Psychophysics*, 38, p. 147. Copyright 1985 by the Psychonomic Society, Inc.

1979; Ludvigh, 1953; Watt & Campbell, 1985; Westheimer, 1981; Westheimer & McKee, 1977). In Section 30, I show that the type of hyperacuity that we have modeled to compensate for positional uncertainty at line ends and corners has also predicted properties of recent data about hyperacuity that possess no other explanation at the present time.

## 12. Boundary-Feature Trade-Off: A New Organizational Principle

The perceptual disaster in question becomes clear when Figure 7 is considered from the viewpoint of the featural filling-in process that compensates for discounting the illuminant. If no BC signals are elicited at the ends of lines and at object corners, then, in the absence of further

processing within the BC System, BCs will not be synthesized to prevent featural quality from flowing out of all line ends and object corners within the FC System. Many percepts would hereby become badly degraded by featural flow. In fact, as Sections 6 and 7 indicated, such featural flows occasionally do occur despite compensatory processing, notably in percepts of neon color flanks and spreading and during stabilized-image experiments.

Thus, basic constraints upon visual processing seem to be seriously at odds with each other. The need to discount the illuminant leads to the need for featural filling-in. The need for featural filling-in leads to the need to synthesize boundaries capable of restricting featural filling-in to appropriate perceptual domains. The need to synthesize boundaries leads to the need for orientation-sensitive receptive fields. Such receptive fields are, however, unable to restrict featural filling-in at scenic line ends or sharp corners. Thus, orientational certainty implies a type of positional uncertainty, which is unacceptable from the perspective of featural filling-in requirements. Indeed, an adequate understanding of how to resolve this uncertainty principle is not possible without considering featural filling-in requirements. That is why perceptual theories

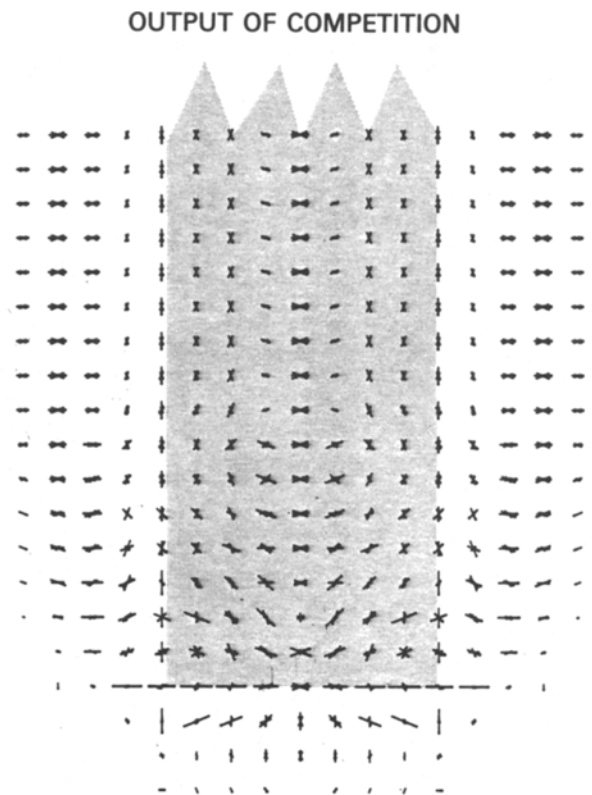

Figure 8. Response of the second competitive stage, defined in Section 14, to the orientation field of Figure 7: End cutting generates horizontal activations at line-end locations that receive small and orientationally ambiguous input activations. Reprinted from "Neural Dynamics of Perceptual Grouping: Textures, Boundaries, and Emergent Segmentations" by S. Grossberg and E. Mingolla, 1985, *Perception & Psychophysics*, 38, p. 147. Copyright 1985 by the Psychonomic Society, Inc.

that have not clearly distinguished the BC System from the FC System have not adequately characterized how perceptual boundaries are formed. We call the design balance that exists between BC System and FC System design requirements the *boundary-feature tradeoff*.

I now summarize how later stages of BC System processing compensate for the positional uncertainty that is created by the orientational tuning of receptive fields.

### 13. All Line Ends Are Illusory

Figure 8 depicts the reaction of the BC System's next processing stages to the input pattern depicted in Figure 7. Strong horizontal activations are generated at the end of the scenic line by these processing stages. These horizontal activations are capable of generating a horizontal boundary within the BC System, whose output signals prevent flow of featural quality from the end of the line within the FC System. These horizontal activations form an "illusory" boundary, in the sense that this boundary is not directly extracted from luminance differences in the scenic image. The theory suggests that the perceived ends of *all* thin lines are generated by such "illusory" line end inductions, which we call *end cuts*. This conclusion is sufficiently remarkable to summarize it with a maxim: *All line ends are illusory*. This maxim suggests how fundamentally different are the rules that generate geometrical percepts, such as lines and surfaces, from the axioms of geometry that one finds in the great classics of Euclid, Gauss, and Riemann.

### 14. The OC Filter and the Short-Range Competitive Stages

The processing stages that are hypothesized to generate end cuts are summarized in Figure 9. First, oriented receptive fields of like position and orientation, but opposite direction-of-contrast, cooperate at the next processing stage to activate cells whose receptive fields are sensitive to the same position and orientation as themselves, but are insensitive to direction-of-contrast. These target cells maintain their sensitivity to *amount* of oriented contrast, but not to the *direction* of this oriented contrast, as in our explanation of Figure 5. Such model cells, which play the role of complex cells in area 17 of the visual cortex, pool inputs from receptive fields with opposite directions-of-contrast in order to generate boundary detectors that can detect the broadest possible range of luminance or chromatic contrasts, as described in greater detail in Sections 23 and 31. These two successive stages of oriented contrast-sensitive cells are called the OC filter (Grossberg & Mingolla, 1985b).

The output from the OC filter successively activates two types of short-range competitive interaction whose net effect is to generate end cuts. First, a cell of prescribed orientation excites like-oriented cells corresponding to its location and inhibits like-oriented cells corresponding to nearby locations at the next processing stage. In other words, an on-center off-surround organization of like-oriented cell interactions exists around each perceptual

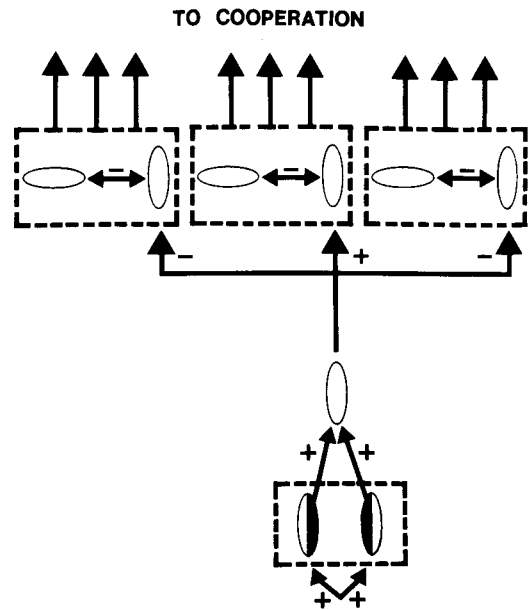

Figure 9. Early stages of boundary-contour processing: At each position exist cells with elongated receptive fields of various sizes which are sensitive to orientation, amount-of-contrast, and direction-of-contrast. Pairs of such cells, sensitive to like orientation but opposite directions-of-contrast (lower dashed box), input to cells that are sensitive to orientation and amount-of-contrast but not to direction-of-contrast (white ellipses). Collectively, these two stages consist of the OC filter, as in Figure 15. These cells, in turn, excite like-oriented cells that correspond to the same position and inhibit like-oriented cells that correspond to nearby positions at the first competitive stage. At the second competitive stage, cells that correspond to the same position but different orientations inhibit each other via a push-pull competitive interaction.

location. The outputs from this competitive mechanism interact with the second competitive mechanism. Here, cells compete that represent different orientations, notably perpendicular orientations, at the same perceptual location. This competition defines a push-pull opponent process. If a given orientation is excited, then its perpendicular orientation is inhibited. If a given orientation is inhibited, then its perpendicular orientation is excited via disinhibition.

These competitive rules generate end cuts as follows. The strong vertical activations along the edges of a scenic line, as in Figure 7, inhibit the weak vertical activations near the line end. These inhibited vertical activations, in turn, disinhibit horizontal activations near the line end, as in Figure 8. Thus, the positional uncertainty generated by orientational certainty is eliminated by the interaction of two short-range competitive mechanisms.

The properties of these competitive mechanisms help to explain many types of perceptual data. For example, they contribute to an explanation of neon color flanks and spreading (Grossberg & Mingolla, 1985a) by showing how some BC signals are inhibited by boundary completion processes. They also clarify many properties of perceptual grouping, notably of the "emergent features" that group textures into figure and ground (Grossberg & Min-

golla, 1985b). Such percepts can be explained by the end-cutting mechanism when it interacts with the next processing stage of the BC System.

### 15. Long-Range Cooperation: Boundary Completion and Emergent Features

The outputs from the competition input to a spatially long-range cooperative process, called the *boundary completion* process. This cooperative process helps to build up sharp coherent global boundaries and emergent segmentations from noisy local boundary fragments. In the first stage of this boundary completion process, outputs from the second competitive stage from (approximately) like-oriented cells that are (approximately) aligned across perceptual space cooperate to begin the synthesis of an intervening boundary. For example, such a boundary completion process can span the blind spot and the faded stabilized images of retinal veins. The same boundary completion process is used to complete the sides of the Kanizsa square in Figure 5. Thus, the boundary completion process can scale itself to span different combinations of scenic inducers. To understand further details about this boundary completion process, it is important to understand that the boundary completion process overcomes a type of informational uncertainty that is different from that depicted in Figure 7.

This type of uncertainty is clarified by considering Figures 10 and 11. In Figure 10a, a series of radially directed black lines induce an illusory circular contour. This illusion can be understood as a byproduct of four processes: Within the BC System, perpendicular end cuts at the line ends (Figure 8) cooperate to complete a circular boundary that separates the visual field into two do-

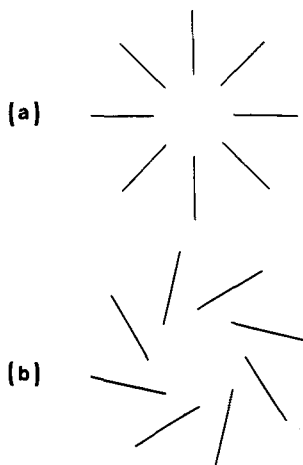

Figure 10. (a) Bright illusory circle induced perpendicular to the ends of the radial lines. (b) Illusory circle becomes less vivid as line orientations are chosen more parallel to the illusory contour. Thus, illusory induction is strongest in an orientation perpendicular to the ends of the lines, and its strength depends on the global configuration of the lines relative to one another. From *Perception and Pictorial Representation* (p. 182) by C. F. Nodine & D. F. Fisher (Eds.). New York: Praeger, 1979. Copyright 1979 by Praeger. Adapted by permission.

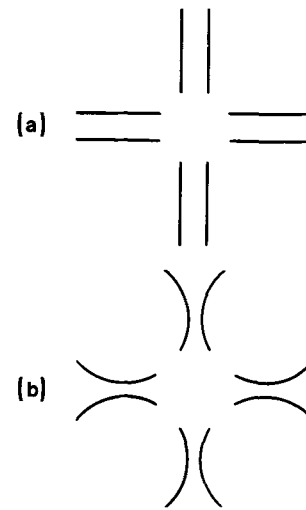

Figure 11. (a) Illusory square generated by changing the orientations, but not the end-points, of the lines in Figure 10a. In (b), an illusory square is generated by lines with orientations that are not exactly perpendicular to the illusory contour. From *Perception and Pictorial Representation* (p. 186) by C. F. Nodine & D. F. Fisher (Eds.). New York: Praeger, 1979. Copyright 1979 by Praeger. Adapted by permission.

mains. This completed boundary structure sends topographically organized boundary signals into the FC System (Figure 1), thereby dividing the FC System into two domains. If different filled-in contrasts are induced within these domains due to the FC signals generated by the black scenic lines, then the illusory circle can become visible. No circle is perceived in Figure 10b because the perpendicular end cuts cannot cooperate to form a closed boundary contour. Hence, the FC System is not separated into two domains capable of supporting different filled-in contrasts.

Figure 11a shows that the tendency to form boundaries that are perpendicular to line ends is a strong one; the completed boundary forms sharp corners to keep the boundary perpendicular to the inducing scenic line ends. Figure 11b shows, however, that the boundary completion process can generate a boundary that is not perpendicular to the inducing line ends under certain circumstances.

### 16. Orientational Uncertainty and the Initiation of Boundary Completion

A comparison of Figures 11a and 11b indicates the nature of the other problem of uncertain measurement that I will discuss. Figures 11a and 11b show that boundary completion can occur within a *band* of orientations. These orientations include the orientations that are perpendicular to their inducing line ends (Figure 11a), as well as nearby orientations that are not perpendicular to their inducing line ends (Figure 11b). Figure 8 illustrates how such a band of end cuts can be induced at the end of a scenic line. Such a band of possible orientations increases the probability that spatially separated boundary segments

can group cooperatively into a global boundary. If only a single orientation at each spatial location were activated, then the probability that these orientations could precisely line up across perceptual space to initiate boundary completion would be small. The (partial) orientational uncertainty that is caused by bands of orientations is thus a useful property for the initiation of the perceptual grouping process that controls boundary completion and textural segmentation.

Such orientational uncertainty can, however, cause a serious loss of acuity in the absence of compensatory processes. If *all* orientations in each band could cooperate with *all* approximately aligned orientations in nearby bands, then a fuzzy band of completed boundaries, rather than a single sharp boundary, could be generated. The existence of such fuzzy boundaries would severely impair visual clarity. Figure 11 illustrates that only a single sharp boundary usually becomes visible despite the existence of oriented bands of boundary inducers. How does the nervous system resolve the uncertainty produced by the existence of orientational bands? How is a single global boundary chosen from among the many possible boundaries that fall within the local oriented bandwidths?

Our answer to these questions suggests a basic reason why later stages of BC processing must send feedback signals to earlier stages of BC processing. This cooperative feedback provides a particular grouping of orientations with a competitive advantage over other possible groupings.

### 17. Boundary Completion by Cooperative-Competitive Feedback Networks: The CC Loop

We assume, as is illustrated by Figure 5, that pairs of similarly oriented and spatially aligned cells of the second competitive stage are needed to activate the cooperative cells that subserve boundary completion (Figure 12). These cells, in turn, feed back excitatory signals to like-oriented cells at the first competitive stage, which feeds into the competition between orientations at each position of the second competitive stage. Thus, in Figure 12, positive feedback signals are triggered in pathway 2 by a cooperative cell if sufficient activation simultaneously occurs in both of the feedforward pathways labeled 1 from similarly oriented cells of the second competitive stage. Then both pathways labeled 3 can trigger feedback in pathway 4. This feedback exchange can rapidly complete an oriented boundary between pairs of inducing scenic contrasts via a spatially discontinuous bisection process.

Such a boundary completion process realizes a new type of real-time statistical decision theory. Each cooperative cell is sensitive to the position, orientation, density, and size of the inputs that it receives from the second competitive stage. Each cooperative cell performs like a type of statistical “and” gate, since it can fire feedback signals to the first competitive stage only if both of its branches are sufficiently activated. We call such cooperative cells *bipole* cells. The entire cooperative-competitive

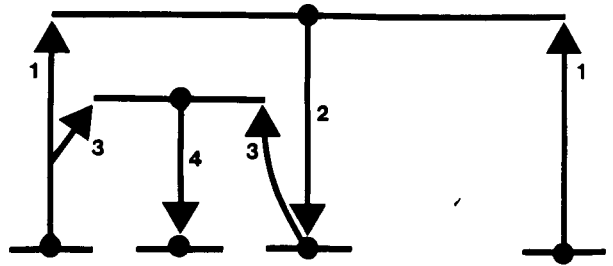

Figure 12. A cooperative-competitive feedback exchange leading to boundary completion: Cells at the bottom row represent like-oriented cells at the second competitive stage whose orientational preferences are approximately aligned across perceptual space. The cells in the top two rows are bipole cells in the cooperative layer whose receptive field pairs are oriented along the axis of the competitive cells. Suppose that simultaneous activation of the pair of pathways 1 activates positive boundary completion feedback along pathway 2. Then pairs of pathways such as 3 activate positive feedback along pathways such as 4. Rapid completion of a sharp boundary between the locations of pathways 1 can hereby be generated by a spatially discontinuous bisection process.

feedback network is called the CC loop. The CC loop can generate a sharp emergent boundary from a fuzzy band of possible boundaries for the following reason (Grossberg & Mingolla, 1985a, 1985b).

As in Figure 8, certain orientations at given positions are more strongly activated than other orientations. Suppose that the cells that encode a particular orientation at two or more approximately aligned positions can more strongly activate their target bipole cells than can the cells that encode other orientations. Then competitive cells of similar orientation at intervening positions will receive more intense excitatory feedback from these bipole cells. This excitatory feedback enhances the activation of these competitive cells relative to the activation of cells that encode other orientations. This advantage enables the favored orientation to suppress alternative orientations due to the orientational competition that occurs at the second competitive stage (Figure 9). Cooperative feedback hereby provides the network with autocatalytic, or contrast-enhancing, properties that enable it to choose a single sharp boundary from among a band of possible boundaries by using the short-range competitive interactions. In particular, if in response to a particular image region there are many small-scale oriented contrasts but no *preferred* orientations in which long-range cooperative feedback can act, then the orientational competition can annihilate an emergent long-range cooperative grouping between these contrasts before it can fully form. Thus, the CC loop is designed to sense and amplify the preferred orientations for grouping and to actively suppress less preferred orientations of potential groupings in which no orientations are preferred. This property is designed into the CC loop using theorems that characterize the factors that enable cooperative-competitive feedback networks to contrast-enhance their input patterns and, in extreme cases, to make choices (Ellias & Grossberg, 1975; Grossberg, 1973; Grossberg & Levine, 1975).

### 18. Dynamic Geometry of Curves: Metacontrast

A preattentive BC System representation emerges when CC loop dynamics approach a nonzero equilibrium activity pattern. The nonlinear feedback process whereby an emergent line or curve is synthesized need not even define a connected set of activated cells until equilibrium is approached. This property can be seen in Figure 13, which illustrates how a sharp boundary is rapidly completed between a pair of noisy inducing elements by the spatially discontinuous bisection process in Figure 12. This process sequentially interpolates boundary components within progressively finer spatial intervals until a connected configuration is attained.

The property of transient disconnectedness is perceptually important. Until a boundary can form a connected set, it cannot separate the perceptual space into two distinct regions. Unless such a separation occurs, the boundary cannot support a visible featural difference within the FC System, as a comparison of Figures 10a and 10b illustrates. Thus only boundaries that are activated by enough visual evidence, and hence possess enough statistical inertia to drive the boundary completion process toward a nonzero stable equilibrium, can have a significant effect on conscious perception. Initial surges of boundary activation can be competitively squelched be-

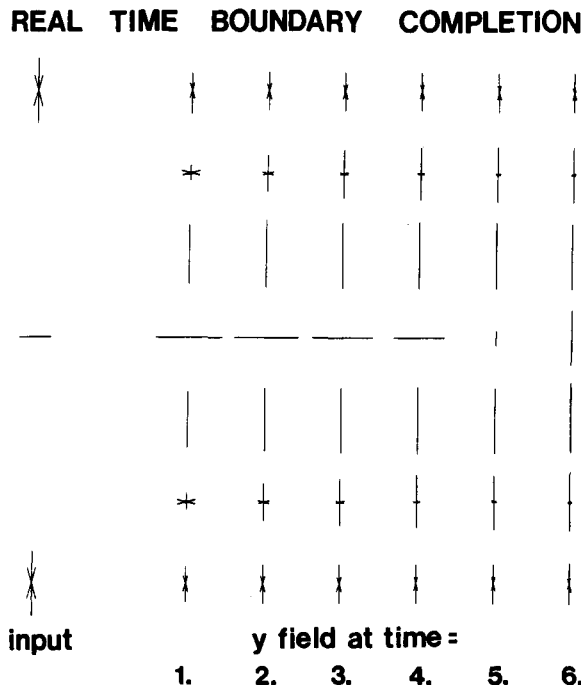

Figure 13. Each column depicts the same band of positions at the second competitive stage (*y* field) at a different time during the boundary completion process. The input (leftmost column) consists of two noisy but vertically biased inducing line elements and an intervening horizontal line element. Line lengths are proportional to the activities of cells with the represented positions and orientational preferences. The cooperative-competitive feedback exchange triggers transient almost horizontal end cuts before attenuating all nonvertical elements as it completes a sharp emergent vertical boundary.

fore a conscious percept can be generated. The phenomenon of metacontrast provides an important set of examples wherein visual inputs can be competitively squelched by a later event before they can organize a conscious percept (Breitmeter, 1978, 1980; Gellatly, 1980; Kaufman, 1974; Reynolds, 1981).

Thus, the CC loop behaves like an on-line statistical decision machine in response to its input patterns. It senses only those groupings of perceptual elements that possess enough "statistical inertia" to drive its cooperative-competitive feedback exchanges toward a nonzero stable equilibrium configuration. After a boundary structure does emerge from the cooperative-competitive feedback exchange, it is stored in short-term memory by the feedback exchange until it is actively reset by the next perceptual cycle. While the boundary is active, it possesses hysteretic and coherent properties due to the persistent suppression of alternative groupings by the competition, the persistent enhancement of the winning grouping by the cooperation, and the self-sustaining activation by the feedback. In addition, the conjoint action of the OC filter and the CC loop reconcile two ostensibly conflicting types of perceptual computation. Inputs from the OC filter to the CC loop retain their "analog" sensitivity to amount-of-contrast in order to properly bias its operation to favor statistically important image groupings. Once the CC loop responds to these inputs, it uses its nonlinear feedback loops and long-range cooperative bandwidths to generate a more structural and "digital" representation of the form within the image. Such a boundary structure is not even remotely like classical definitions of lines and curves in terms of connected sets of points or tangents to these points.

### 19. Spatial Impenetrability and Textural Grouping: Gated Dipole Field

Figure 14 depicts the results of computer simulations that illustrate how these properties of the CC loop can generate a perceptual grouping or emergent segmentation of figural elements (Grossberg & Mingolla, 1985b). Figure 14a depicts an array of nine vertically oriented input clusters. Each cluster is called a Line because it represents a caricature of how a field of OC filter output cells respond to a vertical line. Figure 14b displays the equilibrium activities of the cells at the second competitive stage of the CC loop in response to these Lines. The length of an oriented line at each position is proportional to the equilibrium activity of a cell whose receptive field is centered at that position with that orientation. The input pattern in Figure 14a possesses a vertical symmetry: Triples of vertical Lines are colinear in the vertical direction, whereas they are spatially out of phase in the horizontal direction. The BC System senses this vertical symmetry, and generates emergent vertical boundaries in Figure 14b. The BC System also generates horizontal end cuts at the ends of each Line, which can trap the featural contrasts of each Line within the FC System. Thus, the

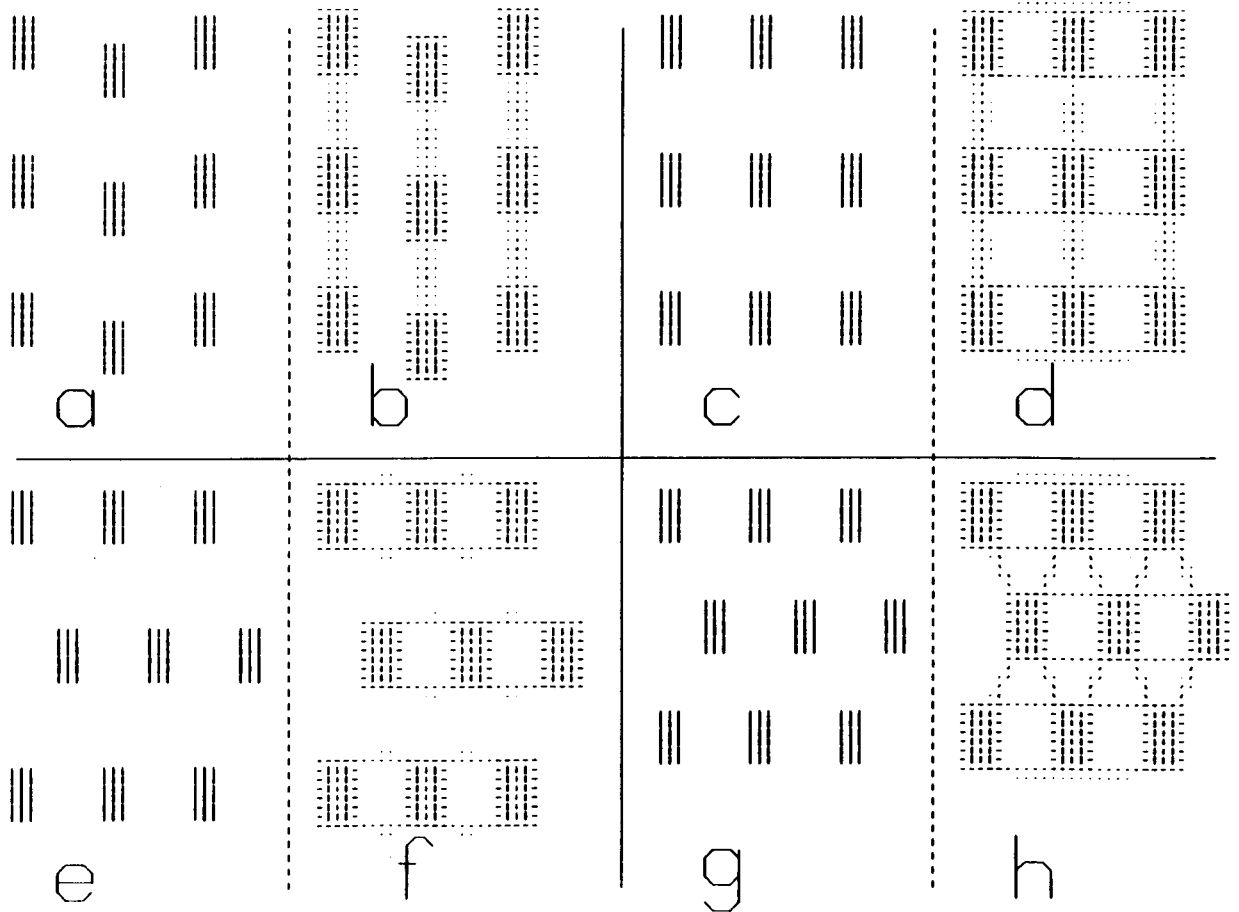

Figure 14. Computer simulations of processes underlying textural grouping: The length of each line segment is proportional to the activation of a network node responsive to one of 12 possible orientations. Parts a, c, e, and g display the activities of oriented cells that input to the CC loop. Parts b, d, f, and h display equilibrium activities of oriented cells at the second competitive stage of the CC loop. A pairwise comparison of (a) with (b), (c) with (d), and so on, indicates the major groupings sensed by the network. From "The Role of Illusory Contours in Visual Segmentation" in *Proceedings of the International Conference on Illusory Contours* by S. Grossberg and E. Mingolla, 1986, New York: Pergamon Press. Copyright 1986 by Pergamon Press. Reprinted by permission.

emergent segmentation simultaneously supports a vertical macrostructure and a horizontal microstructure among the Lines.

In Figure 14c, the input Lines are moved so that triples of Lines are colinear in the vertical direction and their Line ends are lined up in the horizontal direction. Both vertical and horizontal boundary groupings are generated in Figure 14d. The segmentation distinguishes between Line ends and the small horizontal inductions that bound the sides of each Line. Only Line ends have enough statistical inertia to activate horizontal boundary completion via the CC loop.

In Figure 14e, the input Lines are shifted so that they become noncolinear in a vertical direction, but triples of their Line ends remain aligned. The vertical symmetry of Figure 14c is hereby broken. Consequently, in Figure 14f the BC System groups the horizontal Line ends but not the vertical Lines.

Figure 14h depicts the emergence of diagonal groupings where no diagonals exist in the input pattern.

Figure 14g is generated by bringing the three horizontal rows of vertical Lines close together until their ends lie within the spatial bandwidth of the cooperative interaction. In Figure 14h, the BC System senses diagonal groupings of the Lines. Diagonally oriented receptive fields are activated in the emergent boundaries, and these activations, as a whole, group into diagonal bands. Thus, these diagonal groupings emerge on both microscopic and macroscopic scales.

The computer simulations illustrated in Figure 14 show that the CC loop can generate large-scale segmentations without a loss of positional or orientational acuity. In order to achieve this type of acuity, the CC loop is designed to realize the *postulate of spatial impenetrability* (Grossberg & Mingolla, 1985b, 1986a). This postulate was imposed to prevent the long-range cooperative process from leaping over all intervening images and grouping together inappropriate combinations of inputs. The mechanism that realizes the postulate must not prevent like-oriented responses from cooperating across spatially aligned po-

sitions, since such grouping is a primary function of the cooperation. The mechanism does, however, need to prevent like-oriented responses from cooperating across a region of (approximately) *perpendicularly* oriented responses. In particular, it prevents the horizontal end cuts in Figure 14, which are separated by the vertically oriented responses to each Line from activating a receptive field of a bipole cell. As a result, only end cuts at the line *ends* can cooperate to form horizontal boundaries that span two or more lines.

The postulate of spatial impenetrability can be realized by modeling the second competitive stage as a gated dipole field (Grossberg, 1976, 1980). Figure 15 joins together the OC filter with a CC loop whose second competitive stage is a gated dipole field. Such a circuit was used to generate the computer output illustrated by Figure 14. Specialized gated dipole fields are also useful in models of double-opponent color fields (Grossberg, 1987b) and in models of movement segmentation (Section 32). Thus, they seem to realize a general cortical design that can be specialized to accomplish a variety of functions.

In the gated dipole field of Figure 15, the first competitive stage delivers inputs to the on-cells of the field. As previously described, such an input excites like-oriented on-cells at its own position and inhibits like-oriented on-cells at nearby positions. As previously described, on-cells at a given position compete among orientations at the second competitive stage. In addition to on-cells, a gated dipole field also possesses an off-cell population corresponding to each on-cell population. In the network in Figure 15, on-cells inhibit off-cells that represent the same position and orientation. Off-cells at each position, in turn, compete among orientations. Both on-cells and off-cells are driven by a source of tonic activity, which is kept under control by their inhibitory interactions. Thus, an input that excites vertically oriented on-cells at a given position can also inhibit vertically oriented off-cells and horizontally oriented on-cells at that position. In addition, due to the inhibition of like-oriented on-cells at nearby positions, vertically oriented off-cells and horizontally oriented on-cells can be excited due to disinhibition at these nearby positions.

Spatial impenetrability is achieved by assuming that active on-cells send excitatory signals, whereas active off-cells send inhibitory signals, to the similarly oriented receptive fields of bipole cells (Figure 15). Consequently, if horizontally oriented on-cells are active at a given position, they will not be able to activate a horizontally oriented bipole receptive field if sufficiently many vertically oriented on-cells are also active at positions within this receptive field. Each bipole receptive field can help to activate its bipole cell only if its *total* input is sufficiently positive. A bipole cell can fire only if *both* of its receptive fields receive positive total inputs. Sufficiently strong net positive activation of both receptive fields of a bipole cell enables the cell to generate feedback to like-oriented on-cells at the first competitive stage via an on-

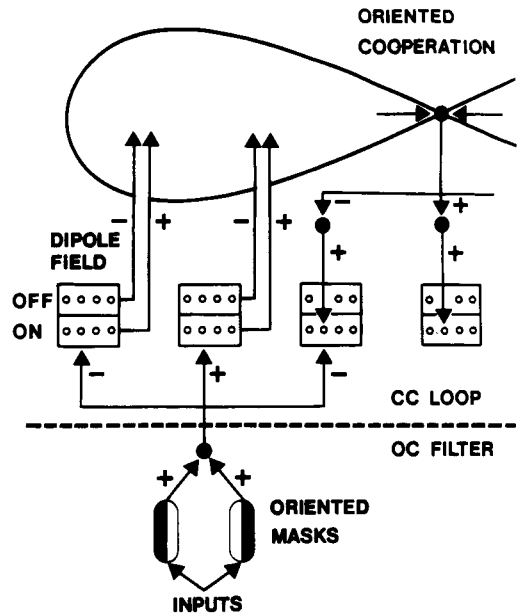

Figure 15. Circuit diagram of the Boundary Contour System: Inputs activate oriented masks of opposite direction-of-contrast which cooperate at each position and orientation before feeding into an on-center off-surround interaction. This interaction excites like orientations at the same position and inhibits like orientations at nearby positions. The affected cells are on-cells within a dipole field. On-cells at a fixed position compete among orientations. On-cells also inhibit off-cells that represent the same position and orientation. Off-cells at each position, in turn, compete among orientations. Both on-cells and off-cells are tonically active. Net excitation of an on-cell excites a similarly oriented cooperative receptive field at a location corresponding to that of the on-cell. Net excitation of an off-cell inhibits a similarly oriented cooperative receptive field of a bipole cell at a location that corresponds to that of the off-cell. Thus, bottom-up excitation of a vertical on-cell, by inhibiting the horizontal on-cell at that position, disinhibits the horizontal off-cell at that position, which in turn inhibits (almost) horizontally oriented cooperative receptive fields that include its position. Sufficiently strong net positive activation of both receptive fields of a cooperative cell enables it to generate feedback via an on-center off-surround interaction among like-oriented cells. On-cells that receive the most favorable combination of bottom-up signals and top-down signals generate the emergent perceptual grouping.

center off-surround interaction. Thus both bottom-up inputs and top-down cooperative feedback access the first competitive stage via an on-center off surround interaction among like-oriented on-cells. On-cells that receive the most favorable combination of bottom-up inputs and top-down signals remain active within the emergent boundary segmentation, as in Figure 14.

The ability of the CC loop to group fuzzy local orientational bands into sharp emergent boundaries illustrates how the imposition of simple perceptual constraints can lead to unsuspected mechanistic conclusions. The need to generate end cuts (Figure 8) capable of preventing the flow of featural quality out of line ends leads to the hypothesis that orientational competition occurs corresponding to each perceptual location (Figure 9) at a prescribed stage of boundary processing. Once orienta-

tional competition is available, the cooperative process that it feeds can use the *same* orientational competition to also help generate sharp boundary segmentations. I will furthermore suggest that the filtering and competitive stages described in Figure 9 generate properties of hyperacuity (Section 30) and border distinctness (Section 31), and provide a new basis for an understanding of how binocular double images are suppressed and of how stereopsis and segmentation mechanisms work together (Grossberg, 1987b). These competitive stages, which are new to our theory, have thus already proved their usefulness in helping to explain much data about vision, and can be multiply tested using several different experimental paradigms.

### 20. Self-Similar Cooperative Scales: $\Delta$ -Neighborhoods and Colinear Boundary Completion During Recognition

Many perceptual properties also follow from the conception of the boundary completion process described in Sections 17-19. For one, the process explicates what is meant by saying that boundary completion is an *inwardly* directed process (Section 8). This type of boundary completion also mechanistically clarifies the empirically derived concept of  $\Delta$ -neighborhood, which Julesz (1985) has used to explain his textural grouping data. The  $\Delta$ -neighborhood is the domain around individual textural elements across which they can group with other texture elements. Julesz has shown that this neighborhood is a factor 2-3 times the size of his individual textural elements. The factor of 2-3 is consistent with the idea that grouping can proceed *inward* when *both* branches of a bipole cell are sufficiently activated. The fact that the same factor 2-3 approximately holds across textural element sizes follows if the bipole cells are assumed to satisfy a *self-similarity* property: A bipole cell with larger receptive fields requires larger total inputs to these receptive fields in order to fire. Thus, a small number of like-oriented image contrasts may be able to supraliminally activate a receptive field of a small bipole cell, but not of a large bipole cell. The self-similarity constraint hereby prevents large groupings from forming in response to insufficient scenic evidence.

Such a self-similarity property among bipole cells clarifies how large-scale illusory figures can sometimes fail to form in images built up from textural elements that are nearly isoluminant (Cavanagh, 1985). Due to the sensitivity of the BC System to amount-of-contrast, as isoluminance is approached, bipole cells with large receptive fields may receive insufficient total inputs to fire, even if small bipole cells continue to fire.

The self-similarity property also suggests why increasing the overall scale of a line drawing in which gaps occur between colinear scenic edges does not damage rapid recognition of the drawing, within certain limits (I. Biederman, personal communication, 1985). By increasing the scale both of the inducing figural elements and of the gaps between these elements, bipole cells with

larger receptive fields can be activated to initiate boundary completion across the larger gaps. These colinear boundaries preattentively complete the image boundaries before the completed boundary segmentation inputs to the ORS (Figure 2). The completed segmentation hereby facilitates recognition of the image even if the emergent boundaries do not support visible contrast differences within the FC System. Many other grouping data have also been analyzed using this conception of the grouping process (Grossberg & Mingolla, 1985a, 1985b, 1987).

### 21. Comparison of Boundary Contour Operations with Striate and Prestriate Cortical Data

Despite the fact that it was derived from perceptual data and concepts, after our theory reached a certain stage in its development, striking formal similarities with recent neurophysiological data became apparent. Some of our perceptually derived neural predictions were already supported by known neural data, albeit data that took on new meaning in the light of the perceptual theory. Most of the predictions were not known, however, and several of them have since been supported by neurophysiological and anatomical experiments. In this section, I begin to describe some of these neural contacts, and will continue to do so with increasing frequency in later sections.

Figure 16 reproduces the theoretical macrocircuit that was introduced in Grossberg (1983a). That article associated the early stage of left-monocular preprocessing ( $MP_L$ ) and right-monocular preprocessing ( $MP_R$ ) with the dynamics of the lateral geniculate nucleus, the first cortical stages in the BC System with the hypercolumns in striate cortex (Hubel & Wiesel, 1977), and the first cor-

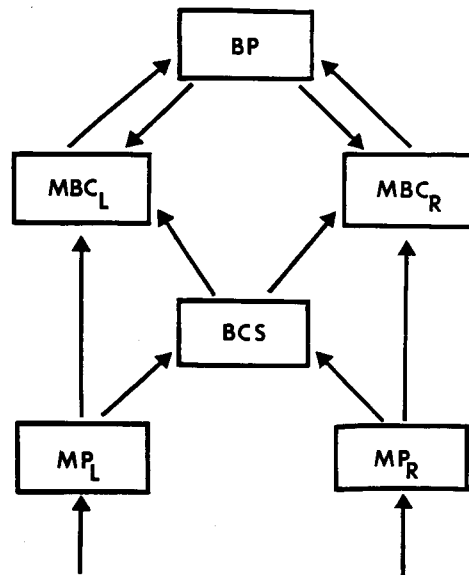

Figure 16. Macrocircuit of processing stages: Boundary-contour formation is assumed to occur within the BCS stage. Its output signals to the monocular  $MBC_L$  and  $MBC_R$  stages define boundaries within which feature-contour signals from  $MP_L$  and  $MP_R$ , respectively, can trigger the spreading, or diffusion, of featural quality.



tical stages in the FC System with the blobs in striate cortex (Hendrickson, Hunt, & Wu, 1981; Horton & Hubel, 1981). This interpretation is compatible with and anticipated some recent cortical data: The LGN projects directly to the hypercolumns as well as to the blobs (Livingstone & Hubel, 1982). The blobs are sensitive to color but not to orientation (Livingstone & Hubel, 1984a), whereas the hypercolumns are sensitive to orientation but not to color (Hubel & Wiesel, 1977; Livingstone & Hubel, 1984b).

Given this neural labeling, the theory predicted that the blobs and the hypercolumns activated testably different types of cortical interactions. These interactions were not required to all occur within the striate cortex, although they were predicted to be triggered by signals from the blobs and the hypercolumns.

Neural data that support our conception of processing stages within the BC System are summarized below. Within the OC filter, hypercolumn cells that are sensitive to orientation, to amount-of-contrast, and to direction-of-contrast are hypothesized to activate cells that are sensitive to orientation and to amount-of-contrast but not to direction-of-contrast (Figure 9). Simple cortical cells that are sensitive to orientation and to direction-of-contrast have been studied by many authors. "Contour-sensitive" complex cells that are sensitive to orientation but insensitive to direction-of-contrast are also well known to occur in area 17 of monkeys (De Valois, Albrecht, & Thorell, 1982; Gouras & Krüger, 1979; Hubel & Wiesel, 1968; Schiller, Finlay, & Volman, 1976; Tanaka, Lee, & Creutzfeldt, 1983) and cats (Hegglund, 1981; Hubel & Wiesel, 1962; Spitzer & Hochstein, 1985). Spitzer and Hochstein (1985) have, moreover, used their cortical data from cats to develop a quantitative model of complex cells that is very similar to the one we independently developed from perceptual data (Grossberg, 1984; Grossberg & Mingolla, 1985a, 1985b).

Such complex cells are predicted by the theory to trigger on-center off-surround interactions among cells of like orientation (Figure 9). Experimental data from monkeys that are consistent with this prediction have been reported by Livingstone and Hubel (1984a), who wrote that "after interstripe injections in area 18 the labeling in the labeled part of area 17 ... formed a regular periodic pattern of parallel stripes with a separation not very different from that of the blobs ... The ordered sequence of orientation shifts found in area 18 ... make it also certain that cells of like orientation are grouped in columns" (p. 339). To more completely test this prediction, it is necessary to record whether excitation of these like-oriented area 18 cells by complex cells of area 17 is correlated with inhibition of like-oriented area 18 cells corresponding to nearby perceptual positions.

Strong experimental support for the theory's predictions concerning the competitive and cooperative stages in Figures 9 and 12 was reported by von der Heydt, Peterhans, and Baumgartner (1984). Recall that these processing stages control competitive end cutting and cooperative-competitive boundary completion within the theory. Given

the previous cellular interpretations, the theory suggests that, although the contour-sensitive complex cells in area 17 may not be able to respond to thin line ends that are perpendicular to their preferred receptive field orientation, as in Figure 7, their target cells in area 18 can respond to line ends that are perpendicular to their preferred receptive field orientation, as in Figure 8. Such responses occur among the cells at both the competitive and the cooperative stages of Figure 12. Moreover, the cooperative cells respond like logical "and" gates to pairs of scenic edges that are similarly oriented and spatially aligned with their receptive fields over a wide perceptual domain, and can relay this excitation back to the corresponding competitive cells, as in Figure 12.

The data of von der Heydt et al. (1984) supported all of these predictions. These authors reported the existence of cells in area 18 of the visual cortex that help to "extrapolate lines to connect parts of the stimulus which might belong to the same object" (p. 1261). They found these cells by using visual images that induce a percept of illusory figures in humans, as in Figures 5 and 11. Concerning the existence of a cooperative boundary competition process between similarly oriented and spatially aligned cells (Figure 12), they wrote: "Responses of cells in area 18 that required appropriately positioned and oriented luminance gradients when conventional stimuli were used could often be evoked also by the corresponding illusory contour stimuli ... The way widely separated picture elements contribute to a response resembles the function of logical gates" (pp. 1261-1262). Concerning the existence of a competitive end-cutting process, they wrote: "The responses to stimuli with lines perpendicular to the cell's preferred orientation reveal an unexpected new receptive field property" (p. 1262). The deep issues raised by these data can be expressed as follows. Why do cells in area 18, which usually react to scenic edges that are parallel to their orientational preference, also react to line ends that are perpendicular to their orientational preference, whereas cells in area 17 do not? Why do the same area 18 cells act as logical gates? Our theory predicted and provides principled explanations of all of these properties.

If we put these several types of experimental evidence together, the theory suggests that the complex cells in area 17 input to the cells that von der Heydt et al. have discovered in area 18. A large number of physiological experiments can be designed to test this hypothesis using stimuli such as those in Figures 3, 5, 10, and 11. Some of these experiments are described in Grossberg and Mingolla (1985a).

The collective impact of these cortical data is promising. When the theory was being formulated, direct neural data concerning the predicted hypercolumn-activated competitive and cooperative interactions were lacking, data concerning the color coding within cortical blobs were lacking, and data concerning independence of contrast within complex cells were well known but used more as a criterion for cell classification than as a functionally meaningful property. The present neural data base is much

more supportive of the theory. The meaning of these data that the theory has proposed is not, however, evident within the experimental articles themselves.

For example, the beautiful experiments of Livingstone and Hubel (1984a, 1984b) led them to distinguish a color system within the blobs and an orientation system within the hypercolumns. In contrast, our theory suggests that cortical hypercolumns in area 17 form part of a boundary completion and segmentation system, rather than part of an orientation system. This difference of emphasis is needed to explain how perceived boundaries can occur corresponding to parts of the visual field in which no oriented receptive fields in area 17 respond at all, as in Figures 5 and 11. This capacity for boundary completion is, moreover, a fundamental one, because it lets the visual system compensate for the retinal veins and blind spot, enables perceptual segmentation into figure and ground to occur, helps to inhibit binocular double images, and prevents flow of colors from line ends and corners. I therefore suggest that the hypercolumns be viewed as part of a boundary system, and not as an orientation system. From this perspective, properties such as independence of direction-of-contrast, multiple types of competition, and oriented cooperative interactions are at least as important as orientational tuning.

## 22. Invisible Boundaries: Contrast Sensitivity Does Not Imply Visibility

This difference of emphasis reflects a major difference in our theory's conception of the global constraints that have molded cortical design. This difference leads to a prediction of our theory which has not yet been physiologically tested. The theory predicts that all BC activations are perceptually invisible within the BC System. Boundary contours are predicted to gain visibility by separating the FC System into perceptual domains that can support different levels of filled-in featural activity. We claim that large activations of contrast-sensitive hypercolumn cells may have no effect whatsoever on conscious perception. In short, *contrast sensitivity does not imply visibility*. Cohen and Grossberg (1984a) and Grossberg and Mingolla (1985a, 1985b, 1987) have analyzed many paradoxical percepts that are consistent with this hypothesis.

The widespread assumption that a hypercolumn cell's contrast sensitivity is simply related to a visible brightness percept has caused a long-standing confusion in the neurophysiological literature. For many years, the wavelength sensitivity of most LGN cells stood in stark contrast to the report of Hubel and Wiesel (1968) that most area 17 cells were insensitive to wavelength. The question "Where did the color go?" weighed heavily on visual neurophysiology for a long time. The elegant discoveries by Zeki (1983a, 1983b) of color-sensitive cells in area V4 of the prestriate cortex did not settle this issue, because V4 receives the bulk of its inputs from area V1 (or 17) and V2 (part of area 18). The discovery of color coding within the blobs (Livingstone & Hubel, 1984a)

relieved part of this concern by suggesting that the wavelength sensitivity of many cells in V1 had previously gone unnoticed because of an electrode sampling bias.

The Livingstone and Hubel (1984a) data have, however, replaced a dearth of wavelength-sensitive cells with an embarrassment of riches that has not been adequately appreciated within the experimental literature. "Too little" has been replaced by "too much." This is because the Livingstone and Hubel (1984a) data reveal a threefold red-green, blue-yellow, and white-black system in each blob, as Hering (1964) would have desired. If, however, there is already a contrast-sensitive white-black system in each blob, then why does the visual system also need a contrast-sensitive white-black system in each hypercolumn? Do *both* of these white-black systems give rise to brightness percepts? To merely say that the hypercolumns form an orientation system does not explain how the contrast sensitivity that subserves orientational tuning contributes to a visible brightness percept.

Widespread acceptance of the term "feature detector" for all cells that are sensitive to luminance or hue differences within scenic images has contributed to this type of confusion. Within our theory, both the BC System and the FC System contain "feature detectors," if only because both systems need to detect contrasts in scenic images. However, we would argue that these "feature detectors" are used within the BC System to generate boundaries, not visible "features." Boundary contours do contribute to visible "featural" percepts, but only indirectly, by defining the perceptual domains within the FC System wherein FC signals can initiate the filling-in of featural activities that may, or may not, lead to visible contrast differences.

Thus, our theory accommodates parallel "feature detector" systems by characterizing the role of one system in generating coherent boundary structures to organize featural filling-in, and the role of the other system in discounting the illuminant to extract the luminance and color contours that trigger featural filling-in within these boundary structures.

## 23. Simple and Complex Striate Cells Revisited

The assumption that "contrast sensitivity implies visibility" has strongly influenced the interpretation of recent striate cortical data. For example, De Valois et al. (1982) provided a lucid discussion of the fact that a fundamental property of a simple cell is its dependence on direction-of-contrast and that of a complex cell is its independence of direction-of-contrast: "The fundamental property of a simple cell, in Hubel and Wiesel's scheme, is that the RF [receptive field] is composed of spatially discrete excitatory and inhibitory regions . . . . The fundamental property of a complex cell, on the other hand, is that it fires similarly to a stimulus regardless of its location within the RF" (p. 553). They also note that, since, in addition, simple cells are slightly more narrowly tuned than complex cells in both spatial frequency and orientation, "it is what one might expect if complex cells were

just summing cells in a hierarchical manner" (p. 555), as was assumed in Hubel and Wiesel's original classification and also on the basis of perceptual evidence (Figure 5) in the present theory (Figure 9). De Valois et al. also noted that "simple cells are phase specific: they respond in opposite direction to white and black . . . . Complex cells . . . are not phase specific: they respond identically to white and black in the same location. The phase specificity of human vision and our ability to tell white from black cannot be explained if complex cells carry the sole output from the striate cortex" (p. 555). The conclusion that complex cells do not carry the sole output from the striate cortex has proved to be correct. These considerations also led De Valois et al. to challenge the hierarchical organization of simple cells into complex cells. Such a challenge is strongly indicated if one also assumes that "contrast sensitivity implies visibility," since, then, the contrast sensitivities of the simple cells and complex cells in hypercolumns are naturally viewed as direct sources of visible percepts. If, however, these contrast sensitivities are used to generate invisible boundary structures, then the hierarchical organization of simple cells and complex cells may coexist with a separate parallel system for processing visible featural qualities, which has proved to be the blob-activated system, at least in monkeys.

Wavelength-sensitive cells of the lateral geniculate nucleus (LGN) are the input sources to both the FC System and the BC System (Figures 1 and 16). This fact sheds new light on recent data concerning responses of striate simple cells and complex cells to color-varying and luminance-varying patterns of different spatial frequencies (Thorell, De Valois, & Albrecht, 1984). The FC System must process its LGN inputs in such a way that double-opponent spectral sensitivities become elaborated and remain segregated in different cell populations. In Sections 24-27 and in Grossberg (1987b) more is said about the processing of FC signals. In contrast, the BC System needs to pool its LGN inputs in such a way that boundary signals will be generated in response to the broadest possible combination of luminance and color differences due to scenic contrasts. In particular, boundaries need to be generated at all locations where a luminance or color contrast must be maintained against the smoothing effects of featural filling-in. Since the striate simple cells of the BC System receive their inputs from wavelength-sensitive LGN cells, these simple cells will respond only to stimuli capable of activating the corresponding wavelength-sensitive LGN cells. On the other hand, the model complex cells of the BC System pool together inputs from like-oriented cells of opposite direction-of-contrast as well as from like-oriented cells of different spectral sensitivities. Thus, the output signals from these complex cells can generate BC inputs to the subsequent competitive and cooperative stages (Figure 9) in response to scenic contrasts arising from a wide range

of luminance and color differences. Although they pool together wavelength-sensitive LGN signals to act as broadband boundary detectors, the complex cells are segregated in terms of their spatial frequency selectivity in order to generate a 3-D segmentation that can distinguish image size on the retina from object size and distance (Grossberg, 1987b).

Thorell et al. (1984) have reported important data from macaque cortex which support all of these expectations. They showed that "simple cells . . . are distinguished by relatively narrow color specificity" (p. 761) and, moreover, that a significant fraction of their simple cells exhibited double-opponent properties. In contrast, "complex color cells . . . responded uniformly to many (or, in the extreme, all) equiluminant wavelength changes . . . . The RFs of many of these cells (15/31, 48%) were composed of overlapping color-regions" (p. 762). Just as BC outputs need to be insensitive to direction-of-contrast, "these cells always responded with the same polarity to all colors tested. This was in keeping with one of the critical features of complex cell behavior: their lack of phase specificity" (p. 764).

Thorell et al. (1984) went on to conclude that these complex cells "must surely be considered color cells in the broadest sense. They clearly use color information to detect the presence of spatial patterns" (p. 768). From the perspective of the present theory, these complex cells seem easiest to understand as part of the BC System. They do "detect the presence of spatial patterns," but this detection, in itself, does not imply that a visible color or brightness percept will be generated. Visible percepts are, I claim, generated within the FC System. Thus, these complex cells should not "be considered color cells" in any psychophysically traditional sense.

Despite this pooling of luminance and color information, "individual cells tend to have similar spatial frequency preferences for color and luminance patterns" (p. 757). In summary, the present theory suggests that the pooling of chromatic information by complex cells enables these cells to provide broadband BC signals to subsequent processing stages, whereas the segregation of spatial frequency information provides a substrate for multiple scale binocular processing of these boundary signals.

#### **24. Feature Contours and Diffusive Filling-In: Syncytial Coupling**

As discussed in Section 5, the FC System first preprocesses visual signals in order to discount the illuminant. The output of these preprocessing stages takes the form of color edges (red-green, blue-yellow, white-black). These color-edge signals form the inputs to the processing stages at which featural filling-in occurs (Figure 1). I will describe a theory of this filling-in process in ever greater mechanistic detail as I proceed.

The existence of two distinct contour-sensitive processes is best demonstrated by the differences that exist between

their processing rules. The rules of contrast obeyed by the FC System are different from those obeyed by the BC System.

**Contrast.** The receptive fields of FC System cells are not oriented, but they maintain their sensitivity to both the *amount* of contrast and the *direction* of contrast in an image at all processing stages, unlike the cells of the BC System. For example, to compute the relative brightness across a scenic boundary, it is obviously important to keep track of which side of the scenic boundary has a larger reflectance. Sensitivity to direction-of-contrast is also needed to determine which side of a red-green scenic boundary is red and which is green. Sensitivity to both amount-of-contrast and direction-of-contrast is needed to enable FC signals to “discount the illuminant.”

The rules of spatial interaction that govern the FC System are also different from those that govern the BC System.

**Diffusive filling-in.** Boundary contours activate a boundary completion process that synthesizes the boundaries that define perceptual domains. Feature contours activate a diffusive filling-in process that spreads featural qualities, such as brightness or color, across these perceptual domains. Figure 17 depicts the main properties of this filling-in process.

It is assumed that featural filling-in occurs within a syncytium of cell compartments. By a syncytium of cells, I mean a regular array of cells in such an intimate relationship to one another that contiguous cells can easily pass electrotonic signals between each other's compartment membranes. In the present instance, an FC input signal to a cell of the syncytium activates that cell. Due to the syncytial coupling of this cell with its neighbors, the activity can rapidly spread to neighboring cells, then to neighbors of the neighbors, and so on. Since the spreading occurs via an electrotonic diffusion of activity, it tends to average the activity that was triggered by the FC input signal across the cells that receive this spreading activity. The activity spreads across the syncytium with a space constant that depends upon the electrical properties of both the cell interiors and their membranes. The electrical properties of the cell membranes can be altered by BC signals in the following way.

A BC signal is assumed to decrease the diffusion constant of its target cell membranes within the cell syncytium. It does so by acting as an inhibitory gating signal that causes an increase in cell membrane resistance. At the same time that a BC signal creates a barrier to the filling-in process at its target cells, it also acts to inhibit the activity of these cells. Thus, due to the physical process whereby a BC limits featural spreading across the syncytium, a BC input also acts as an FC input to its target syncytial cells.

Such a diffusive filling-in reaction is hypothesized to instantiate featural filling-in over the blind spot, over the faded images of stabilized retinal veins, and over the illuminants that are discounted by FC preprocessing.

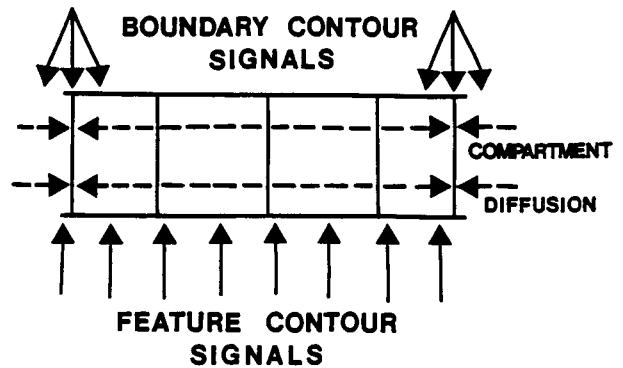

Figure 17. A monocular syncytium, or filling-in domain, within the Feature Contour System: Feature-contour signals activate cell compartments that permit rapid lateral diffusion of activity, or potential, across their compartment boundaries, except at those compartment boundaries which receive boundary-contour signals from Boundary Contour System. Consequently, the feature-contour signals are smoothed except at boundaries that are completed within the Boundary Contour System stage.

Our mechanistic model of these qualitative concepts, which was introduced in Grossberg (1983a, 1983b), has been developed by Cohen and Grossberg (1984a) to quantitatively simulate on the computer such paradoxical brightness data as versions of the Craik-O'Brien-Cornsweet effect (Arend et al., 1971; Cornsweet, 1970; O'Brien, 1958) and its exceptions (Coren, 1983; Heggelund & Krekling, 1976; Todorović, 1983; van den Brink & Keemink, 1976), the Bergström (1966, 1967a, 1967b) demonstrations comparing the brightness profiles of smoothly modulated and step-like luminance profiles, and the Hamada (1980) demonstrations showing nonclassical differences between the perception of luminance decrements and increments. In addition, this filling-in model helps to physically explain the brightness and color phenomena for which the Land (1977) retinex theory was developed, and suggests explanations of many phenomena that the Land theory cannot explain, such as neon color spreading and “illusory” brightness and color phenomena, as in Figures 3, 4, and 11 (Grossberg, 1984; Grossberg & Mingolla, 1985a).

Of course, no behaviorally derived mathematical model can impose a unique physiological and biochemical interpretation upon its formal operations. Our theory does, however, make strong functional demands upon possible physiological substrates of filling-in. In particular, a dense array of BCs must be able to parse a filling-in domain into very small, and sharply delineated, spatial compartments. This property suggests that the individual cellular units that comprise these compartments are also very small. On the other hand, widely separated BCs must also be able to define large filling-in compartments. This property suggests that contacts between the individual small cells are able to pass filling-in signals easily to their neighboring cells in the absence of boundary obstructions. In addition, the filling-in process is an averaging process

that is attenuated at a determinate rate with distance. All of these constraints suggest the existence of small, diffusively coupled cells whose membranes can be gated shut by BC signals. Finer model details were derived through a process of quantitative computer simulation of psychophysical brightness data (Cohen & Grossberg, 1984a). Any physiological realization of such a featural filling-in process must therefore obey the highly constraining functional properties that are satisfied by the present instantiation.

## 25. Chemical and Electrotonic Signalling at Gap Junctions

Recent physiological and pharmacological data lend support to the particular physiological mechanisms that we have used to interpret our featural filling-in model. We suggest that the cortical filling-in process is functionally homologous to the types of interactions that have been reported in the horizontal cell layers of vertebrate retinas (Piccolino, Neyton, & Gerschenfeld, 1984; Skrzypek, 1984; Usui, Mitarai, & Sakakibara, 1983). In our model and in these data, electrotonic interactions between contiguous cell membranes mediate the filling-in reaction. In vivo, the electrotonically interacting cells are often separated by gap junctions. Chemical transmitters alter the ability of the gap junctions to pass electrotonic signals by functionally decoupling the cells. The Piccolino et al. (1984) results on the turtle retina are most closely related to our filling-in model. These authors reported that "the axon terminals of the H1 horizontal cells of the turtle retina are electrically coupled by extensive gap junctions. Dopamine . . . induces a narrowing of the receptive field profile of the H1 horizontal cell axon terminals, increases the coupling resistance between them, and decreases the diffusion of the dye Lucifer Yellow in the network formed by the coupled axon terminals" (p. 2477).

This description is consistent with the formal filling-in model that we derived from perceptual data about brightness perception. It also refines our model by suggesting that axo-axonal interactions, but not soma-soma interactions (Skrzypek, 1984), may mediate the electrotonic flow. We originally speculated that dendrodendritic interactions may have played this role, but the formal structure of our model would not change if axo-axonal interactions were reported in the predicted cortical syncytium. If, in addition, the formal homolog between retinal and cortical syncytia extends to the pharmacological level, then the transmitter that mediates BC signals to the FC syncytia is expected to be a catecholamine. The existence and properties of such cortical filling-in mechanisms can be experimentally tested by using the analysis in Grossberg (1987b) to suggest where in the cortex the formal FC System stages schematized in Figure 1 should be found.

## 26. Retinal versus Cortical Filling-In

If a homolog indeed exists between filling-in within the retina and filling-in within the cortex, then why is the cor-

tex necessary, especially given the recent report that goldfish can make many of the color discriminations required by the Land experiments (Ingle, 1985)? I suggest that this process of encephalization permits more elaborately processed BC signals to input topographically to the FC System. In particular, the multiple scale, binocular boundary interactions that support depth percepts (Grossberg, 1987b) and the top-down "cognitive" boundary signals that help to complete form percepts of familiar objects (Figure 2) both require the additional stages of processing that cortex permits. The process of monocular discounting of illuminants does not require this degree of preprocessing.

Striate and prestriate cortical data concerning color interactions are far from complete, but are consistent with our theory as far as they go (Desimone, Schein, Moran, & Ungerleider, 1985; Livingstone & Hubel, 1984a, 1984b; Zeki, 1983a, 1983b). Before suggesting explanations and predictions concerning such data, I will use BC System and FC System properties to clarify five illustrative percepts. In Grossberg (1987b), I address the question of how binocular boundaries are synthesized, and how they regulate visible depth, brightness, color, and form percepts to build up a modeling framework in which further cortical data can be analyzed.

## 27. Tissue Contrast

The tissue contrast experiment was already familiar to Helmholtz (1909/1962). I suggest that its deceptive simplicity hides a deep property of cortical processing.

To perform the experiment, place a gray circular disk on top of a red background. Cover the whole figure with a white piece of tissue paper that lets the colors be seen but attenuates the contrast at the red-gray edge. Then the gray area looks green. Draw a circle with a black pen on the tissue to divide the circular area from the background. The gray area looks gray again.

I suggest the following explanation of this classical phenomenon. The tissue does not totally obliterate BC activation at the red-gray interface. In fact, if no boundary could form, then the image would become a functional ganzfeld and no chromatic difference could be perceived. The tissue does, however, alter the processing within both the BC System and the FC System. It creates a good approximation to a sharp red-gray spatial transition. Thus, the boundary formed at this interface within the BC System is very thin. In addition, double-opponent color processing of FCs within the FC System enables the red input to activate green channels at positions just interior to the circle. These green FC signals can fill-in the entire circle within their cell syncytium due to the absence of boundary obstructions within this syncytial domain.

Drawing the black circle on the tissue has coordinated effects on both BC and FC processing. To understand these effects, recall from Figure 7 that a scenic line generates a complex spatially structured activation pattern, with a determinate thickness, across the receptive fields of the BC System. A black scenic line can therefore replace the

thin boundary that forms in response to the tissue-covered image with a thicker boundary structure that possesses a determinate interior. A black scenic line can also dramatically alter the reaction of double-opponent color cells within the FC System. Double-opponent cells at the outer edge of the black line respond to a red-black contrast. Double-opponent cells at the inner edge of the black line respond to an achromatic black-gray contrast rather than to the chromatic red-gray contrast of the tissue condition. Consequently, no complementary color induction occurs within the interior of the circle. In addition, the boundary structure induced by the black line separates the cell syncytium into three, rather than two, separate filling-in domains. The inner domain fills in achromatic FC signals rather than the green FC signals of the tissue condition.

### 28. Perception of Continuously Shaded Curved Surfaces: Boundary Webs

The next example consistently applies the idea that colors flow down electrotonic gradients unless barriers are generated within their cell syncytia by BC signals. Given this hypothesis, how can we perceive the smoothly shaded interiors of curved surfaces? Why do the color signals interior to such a surface not flow until the surface is perceived to be flat? In order to answer such questions, we are led to a concept of a surface percept that is just as nonclassical as our concept of a line or a curve.

To begin an explanation of surface perception, recall that oriented receptive fields within the BC System are local *contrast* detectors, not merely *edge* detectors (Section 10). If the luminance gradient of the shaded surface is sufficiently steep and oriented, then it can preferentially activate complex cells whose orientations are aligned along the luminance gradient. These activated complex cells can then engage the cooperative-competitive feedback loops of the CC loop, just as if they had been activated by scenic edges. If the luminance gradient exists over a large spatial domain, then it can generate a form-sensitive mesh, coordinate system, or *boundary web*, of completed BCs. Most of the boundaries in a boundary web are illusory boundaries, as in Figures 5, 10, and 11. Such a boundary web can partition the region of the BC System that corresponds to the surface into a large number of compartments whose size and shape reflect the form of the inducing image or scene. Within the full 3-D theory, the BC System is divided into several parallel subsystems, such that each subsystem corresponds to a different spatial scale, or range of receptive field sizes (Figure 6). Each receptive field size is sensitive to a different range of continuous changes in image contrast across the surface image, and each spatial scale possesses its own CC loop. Consequently, each spatial scale of the BC System can generate its own distinct boundary web. In Grossberg (1987b), I discuss how such a multiple-scale boundary structure can be the basis for a 3-D form percept.

If a boundary web can, indeed, be generated by sufficiently steep luminance gradients, then why can we not

see these boundaries? At this juncture, I depend heavily upon the theory's radical claim that *all* boundaries are invisible until they can support different filled-in featural contrasts within the FC System (Section 22). This claim is radical because it reverses the dictates of lay intuition. Instead of taking for granted that all boundaries can be seen, we now must actively explain why some boundaries can ever become visible.

When a fine boundary web divides the FC System into small syncytial compartments, the filled-in contrasts between neighboring compartments are often similar. Thus, the boundary web reveals itself through the very fact that it can support a percept of an approximately continuous brightness or color gradient that is much less uniform than would be expected were unobstructed filling-in to occur.

The hypothesis that a boundary web supports percepts of surface gradients immediately makes many facts intuitively clearer. A boundary web can bridge surface regions where highlights occur by using its colinear boundary completion properties. It can resist distortion due to local changes in illuminant intensities by using the hysteretic and coherent "structural" properties of the CC loop. Although the boundary web may maintain its coherent structure as illuminant intensities vary, the FC signals that activate featural filling-in of boundary web compartments can remain sensitive to changes in scenic reflectances. Thus, the problem of explaining the simultaneous apprehension of a stable shape and of the volatile surface appearances that are perceived as occurring on this shape is translated by the theory into an analysis of how a coherent 3-D segmentation, which is generated by a surface within the BC System, supports the filled-in percept of surface form-and-color-in-depth, which is generated within the FC System (see Grossberg, 1987b).

Grossberg and Mingolla (1987) further develop this theory of surface perception and describe computer simulations that show how boundary webs within multiple spatial scales can support a 3-D percept of a continuously shaded object. Todd and Akerstrom (1986) have used the theory to quantitatively explain their data concerning shape from texture—namely, how the grouping of textural elements can impart a depthful appearance to an otherwise ambiguous 2-D image of a surface. Such successful comparisons between theory and data highlight the ability of a spatially discrete boundary web to simultaneously encode both smooth shading and discrete boundary and textural elements into a single form-sensitive network of boundary compartments.

### 29. Sine-Wave Gratings as Surface Images: Lateral Inhibition Between Spatially Adjacent Spatial-Frequency Channels

The concept of the visual system as a spatial frequency filter has enjoyed such enormous success that it need not be reviewed again here. On the other hand, a supra-threshold image of a sine-wave grating is also a 2-D image of a possible 3-D surface, and thus it must activate many of the same processes as do more complex surface im-

ages. Many of the most useful psychophysical images, such as sine-wave gratings, are not salient cues for raising issues about image segmentation and filling-in. However, once the generality of these issues becomes clear through an analysis of other types of perceptual data, these issues must also be raised for the case of sine-wave gratings. In particular, we suggest that a sine-wave image, no less than any other surface image, generates a boundary web within the BC System that supports a percept of its nonuniform brightness distribution within the FC System. Thus, at suprathreshold luminances, a number of perceptual effects may be expected to occur in response to sine-wave gratings, as well as other psychophysical stimuli, that cannot be explained using a classical modulation transfer function approach. In more mechanistic terms, such data indicate the limits of otherwise successful psychophysical models based entirely on internal receptive-field structure and nonlinear transduction of receptive-field responses, such as the model of Wilson and Bergen (1979) and Wilson (1986).

A number of experiments on sine-wave gratings point to the types of segmentation interactions that are posited within our theory. These experiments have analyzed how perceived contrast and spatial frequency change as a function of physical contrast for different spatial frequencies. Quinn (1985) has reviewed and confirmed a number of studies that demonstrate a perceived contrast equivalence at low and intermediate spatial frequencies; yet, at high spatial frequencies, perceived contrast surpasses that at an intermediate spatial frequency. Sagi and Hochstein (1984) have reported similar data. They explain their data in terms of "a new lateral inhibitory phenomenon . . . between spatially neighboring channels that detect similar spatial frequencies . . . . At high contrasts, the effect is an enhancement of grating contrast near its border, whereas at near threshold contrasts, an opposite effect, edge contrast diminution, is seen . . . . This shift may also be responsible for the phenomenon of contrast constancy" (Sagi & Hochstein, 1985, p. 315). In the contrast constancy phenomenon (Georgeson & Sullivan, 1975), the apparent contrast of intermediate frequencies rises gradually with stimulus contrast, whereas the apparent contrast of higher spatial frequencies rises more rapidly. In their model of these phenomena, Sagi and Hochstein (1985) posit the existence of a processing stage, subsequent to their model's receptive field stage, at which lateral inhibition occurs across perceptual locations but within each spatial frequency channel.

We link our theory to the Sagi and Hochstein (1985) model by noting that the first competitive stage (Figure 9) contains lateral inhibitory interactions subsequent to the receptive fields of the OC filter. In the full 3-D theory that is developed in Grossberg (1987b) receptive fields of different sizes (Figure 6) exist in separate copies of the OC filter. These distinct OC filters interact with distinct copies of the CC loop to generate a multiple-scale segmentation of the scenic image. Thus, the lateral inhibitory stage described by Sagi and Hochstein (1985) is

consistent with our model's earliest stage of CC loop processing.

### 30. Spatial Localization and Hyperacuity

The model's posited interactions between receptive field and segmentation mechanisms are also supported by recent psychophysical data about spatial localization and hyperacuity. In Section 11, it was pointed out that a selective pressure toward hyperacuity exists in nervous systems that are capable of processing the long edges of thin lines. To prevent featural flow from occurring out of line ends and corners, spatially short-range competitive interactions (Section 14) are needed to generate end cuts at the positions corresponding to line ends. These end cuts exhibit properties of hyperacuity (Figure 8), because they are localized at the position of a line end with a much finer spatial resolution than could have been expected from the larger sizes of individual elongated receptive fields alone (Figure 7).

In a series of experiments studying spatial localization and hyperacuity, Badcock and Westheimer (1985a, 1985b) have presented psychophysical evidence that strongly supports our conception of how oriented receptive fields average scenic luminances, pool their inputs to become independent of direction-of-contrast, and then excite like-oriented cells at the same position while inhibiting like-oriented cells at nearby positions (Figure 9). Badcock and Westheimer (1985a) used flanking lines to influence the perceived location of a test line. They varied the position of the flank with respect to the test line as well as the direction-of-contrast of flank and test lines with respect to the background. They found that two separate underlying mechanisms were needed to explain their data: a mechanism concerned with the luminance distribution within a restricted region and a mechanism reflecting interactions between features. Within the central zone defined by the first mechanism, sensitivity to direction-of-contrast was found, as would be expected within an individual receptive field. On the other hand, a flank within the surround region always caused a repulsion, that was independent of direction-of-contrast. Thus, "when flanks are close to a target line, it is pulled towards the flank for a positive flank contrast but they push each other apart if the flank has a negative contrast. A flank in the surround region always causes repulsion under the conditions presented" (p. 1263). To further test independence of direction-of-contrast due to the surround, they also found that "the effect of a bright flank on one side can be cancelled by a dark flank on the other. Within the central zone this procedure produces a substantial shift of the mean of a positive contrast target line towards the positive contrast flank" (p. 1266).

Badcock and Westheimer (1985a) have noted that the averaging of luminance within the central zone is sensitive to amount-of-contrast and direction-of-contrast in a way that is consistent with a difference-of-gaussian model. Such a computation also occurs at the elongated receptive fields, or input masks, of the BC System (Figure 6).

Pairs of simple cells with like positions and orientations but opposite directions-of-contrast then add their rectified outputs at complex cells, which are, as a consequence, insensitive to direction-of-contrast (Figure 9). Such cells provide the inputs to the first competitive stage. The oriented short-range lateral inhibition at the first competitive stage is thus insensitive to direction-of-contrast, has a broader spatial range than the central zone, and, being inhibitory, would always cause repulsion—all properties of the Badcock and Westheimer (1985a) data. In summary, all the main effects in these data mirror properties of the circuit in Figure 9.

In further tests of the existence and properties of these distinct mechanisms, Badcock and Westheimer (1985b) noted that “in the surround zone the amount of repulsion obtained was not influenced by vertical separation of the flank halves, even when they were several minutes higher (or lower) than the target line. In the central zone attraction was only obtained when the vertical separation was small enough to provide some overlap of lines in the horizontal direction” (p. 3). These data further support the idea that the central zone consists of individual receptive fields, whereas the surround zone is due to interactions across receptive fields, which are first processed to be independent of direction-of-contrast, as in Figure 9. In our computer simulations of boundary completion and segmentation (Grossberg & Mingolla, 1985a, 1985b), it was assumed that the lateral inhibition within the first competitive stage was not restricted to any preferred orientation, as is also true of the surround repulsion effect in the Badcock and Westheimer (1985b) data.

Badcock and Westheimer (1985a) also compared their data with the results of earlier workers who were studying figural aftereffects. They reviewed experiments in which “the amount of repulsion also increases as luminance contrast increases (Pollack, 1958) although contrast polarity is not an important factor (Ganz, 1964) as was found in the current study employing hyperacuity tasks” (p. 1267). This result is consistent with the model property that the input to the first competitive level is sensitive to amount-of-contrast but not to direction-of-contrast. They also noted that “both Köhler and Wallach (1944) and Ganz and Day (1965) have demonstrated that repulsion can be obtained using dichoptic presentation while the latter failed to find interocular transfer for the attraction effect. These results suggest that attraction seems to reflect properties of the monocular pathways while repulsion involves at least some binocular components” (p. 1267). These properties are consistent with the analysis in Grossberg (1987b), which suggests that the complex cells that generate inputs to the first competitive level are binocular cells, in fact disparity-sensitive cells, whereas the simple-cell receptive fields that define the center zone are more monocular.

The integration of several types of experimental results using BC System interactions suggests that the competitive bandwidth that has been identified in the above hyper-

acuity and figural aftereffect studies is the same bandwidth that controls many examples of neon color spreading (Redies & Spillmann, 1981), the end cuts found by von der Heydt et al. (1984) at cells within cortical area 18, the initiation of preattentive textural grouping by colinear line ends (Beck, Prazdny, & Rosenfeld, 1983), and the lateral inhibition that occurs within spatial-frequency channels (Sagi & Hochstein, 1985). The theory suggests that all these phenomena reflect the nervous system's compensation for the fact that “orientational certainty implies positional uncertainty at line ends and corners” (Section 11). In addition, it is suggested in Grossberg (1987b) that these competitive interactions play an important role in the binocular suppression of double images and in binocular rivalry phenomena. Now that so many different types of data have been mechanistically related as manifestations of this design, a large number of new types of experiments can be carried out to discover finer details of these BC System mechanisms.

A number of other psychophysical experiments on hyperacuity implicate segmentation mechanisms in addition to the more familiar receptive-field mechanisms. For example, in their studies of vernier acuity, Watt and Campbell (1985) have systematically varied the lengths of a pair of thin comparison bars as well as the sizes and location of gaps within these bars. They concluded that the effect of gap size “is consistent with the suggestion that the cue is the orientation of an imaginary line [read, emergent segmentation] joining the inner ends of the two bars” (p. 36), that “line terminations [read, end cuts] segment a line prior to accurate shape analysis” (p. 37), and in general that “experiments on Vernier acuity demonstrate a piecewise and structural analysis of the target” (p. 38).

Once the relevance of BC System mechanisms to an analysis of hyperacuity data is acknowledged, it also becomes clear that the psychophysical literature has not fully analyzed the cues subjects can use to make their discriminations. As Figure 2 indicates, an emergent segmentation within the BC System may sometimes be used to recognize a discrimination within the Object Recognition System even if it does not support a large visible contrast difference. Psychophysical measurements of visible contrast changes probe primarily the outcome of FC System processes and their projections to the Object Recognition System. Although such visible contrast changes often covary with contrast-sensitive changes in the BC System, sometimes they do not, as when an “imaginary line” influences vernier acuity. To deal with such properties of psychophysical data, theoretical analyses will need to distinguish between the FC System processes which directly control visible contrast differences via the progressive elaboration and filling-in of FC signals, and the BC System processes which indirectly control visible contrast differences via the emergent segmentations whose selections of FC signals and filling-in domains influence conscious perception.



Another type of psychophysical data that is clarified by BC System and FC System properties is summarized in the next section.

### 31. Border Distinctness, Blue Cones, and Neon Color Spreading

Boynton, Eskew, and Olson (1985) have recently performed psychophysical experiments to further test the role of blue cones in the "melting" of borders, which was previously reported by Tansley and Boynton (1976, 1978). Their studies are consistent with the hypothesis that wavelength-sensitive opponent inputs from the lateral geniculate nuclei to the BC System are combined to generate a chromatically broadband boundary signal (Section 23), whereas opponent inputs from the lateral geniculate nuclei to the FC System are kept separate and further articulated to generate double-opponent color percepts (Grossberg, 1987b).

In support of this general conception, Boynton et al. (1985) reported that, in their experiments, "changes in contour are much more obvious than changes in color, and that in the main experiment we were attending not to differences in color but, as intended, to variations in the strength of contour" (p. 1350). Moreover, "blue cones may form contours directly and . . . in addition they form contours indirectly by influencing the effects of red cone excitation" (p. 1351). In summary, these studies support the hypothesis that opponent information from the lateral geniculate nuclei is used in parallel in two different ways: to generate color and brightness signals and to generate broadband boundary signals.

Our model of how broadband boundary signals are synthesized is supported by the model of Tansley, Robertson, and Maughan (1983) which posits that luminance and chromatic signals converge upon common target cells to generate "perception of edges" or "edge distinctness." In this model, only L and M cones are assumed to play a role. The luminance channel processes an  $(L+M)$  input, and the chromatic channel processes an  $(L-M)$  input. The magnitude of the edge signal is assumed to increase with the  $\log_{10}$  of the difference between the  $(L+M)$  signals or the  $(L-M)$  signals arising from either side of the border in the scenic image. The data of Boynton et al. (1985) suggest that blue cones also input to this boundary detection system.

Tansley et al. (1983, p. 452) also went on to suggest, however, that "the results of McCollough-type experiments should be predictable" from their model. I believe that this suggestion confuses BC System properties with FC System properties. It does not clearly distinguish between boundary formation per se within the BC System and its role in supporting visible contrast differences within the FC System. An explanation of many McCollough effect properties is developed in Grossberg (1987b) and makes major use of differences between BC System and FC System processes.

Ejima et al. (1984) have reported psychophysical data that support our analysis of how neon color spreading

(Section 7) is related to border distinctness. These authors used variants of the stimulus pattern in Figure 4a in which the wavelengths of the Ehrenstein pattern and the crosses were independently varied from 460 to 680 nm in 20-nm steps. Observers were asked to judge the strength of the illusory spread of neon color around the center crosses for each wavelength combination. The results led the authors to draw an explicit connection with the Tansley and Boynton (1978) study on border distinctness. They concluded that the strength of the neon color effect was correlated with the spectral purity difference  $P_{\text{crosses}} - P_{\text{E pattern}}$ . This quantity provides a good first approximation to our theoretical explanation of how well the BC formed by the Ehrenstein pattern can inhibit the contiguous BC formed by the cross, thereby allowing FC signals to flow across the corresponding region within the corresponding syncytium of the FC System (Grossberg & Mingolla, 1985a).

Various other data properties reported by Ejima et al. (1984) are consistent with the model. Thus, the strength of the neon effect is "independent of the illuminance level of the crosses when the illuminance ratio to the Ehrenstein pattern is maintained" (p. 1726). This property supports the hypothesis that inhibition at the first competitive stage is of a shunting, or divisive, type (Grossberg & Mingolla, 1985a). When achromatic line patterns are used, an illuminance ratio of the Ehrenstein pattern to the crosses that is greater than 1 is needed to generate the effect (van Tuijl & de Weert, 1979). This fact is consistent with the following properties: (1) inhibition of the cross boundary by the Ehrenstein pattern helps to initiate the effect, and (2) the inhibition is sensitive to amount-of-contrast of the inducing scenic figures to their respective grounds. When chromatic line patterns are used, "a just noticeable effect requires luminance ratios of less than 1 . . . for wavelengths of the crosses eliciting weaker effects . . . the illuminance ratios required for a just noticeable effect are higher than for wavelengths of the crosses eliciting stronger effects" (p. 1725). This fact supports the concept that achromatic and chromatic signals are pooled within the BC System to generate a broadband boundary signal.

Further studies aimed at consciously separating the influence of lateral geniculate opponent signals on parallel color and boundary systems are needed and can profitably employ the Boynton paradigm. In particular, isoluminance in a scenic image does not necessarily imply zero contrast detection by the complex cells that input to the CC loop. Indeed, if no receptive fields could generate inputs to the CC loop, then the CC loop would detect a functional ganzfeld and could not support any preattentive form or color percept whatsoever. It would therefore be most useful to have parametric physiological data concerning the manner in which complex cells respond to isoluminant scenes that are constructed from different chromatic scenic combinations. Such data could form a secure basis for deriving conclusions about the distinctness of boundaries and of perceptual groupings, un-

contaminated by the perceived color or brightness differences that these boundaries support within the FC System.

### 32. Movement Segmentation

Although the OC filter and CC loop circuits were developed to explain percepts of static images, they also respond well to a variety of moving images. This observation does not challenge the well-documented role of cortical systems, such as MT, which are specialized for the processing of motion (Albright, Desimone, & Gross, 1984; Maunsell & Van Essen, 1983; Newsome, Gizzi, & Movshon, 1983; Zeki, 1974a, 1974b). It merely notes that a single cortical system may be used to represent aspects of 3-D form in response to both static and moving images. In addition, although the cortical systems that process form and motion information may be anatomically distinct, model mechanisms that have been proposed to derive form-from-motion bear striking resemblances to CC loop mechanisms. Thus, the CC loop may be a specialized version of a more general cortical design.

The above assertions are illustrated by a consideration of how the CC loop responds to differentially moving random dots (Braddick, 1974; Julesz, 1971; Lappin & Bell, 1976; Nakayama, 1985; Nakayama, Silverman, MacLeod, & Mulligan, 1985; Nakayama & Tyler, 1981). As illustrated by Figure 6, an oriented receptive field of the CC loop responds best if a dot density difference that is parallel to the preferred receptive field orientation moves in a direction perpendicular to the preferred receptive-field orientation (Nakayama et al., 1985). Where local random dot motions are superimposed upon such statistical drifts, the system could fail to respond well were it not for CC loop mechanisms. In particular, orientational competition within the second competitive stage (Figure 9) amplifies the preferred combination of dot-density orientation and direction of movement while suppressing less preferred combinations. Then the cooperation can begin to group together these preferred combinations of dots into emergent segmentations of the image.

Both competitive stages of the CC loop are formally analogous to model mechanisms that Nakayama and Loomis (1974) have proposed for the extraction of a figural boundary moving relative to a ground, and could be used to generate the properties of cells that Frost and Nakayama (1983) have discovered within the intermediate and deeper layers of the pigeon optic tectum. Figure 18 describes two variants of this model. In both variants, cells that respond to the same direction-of-motion interact via an on-center off-surround network. If the preferred direction-of-motion of a cell is perpendicular to its preferred orientation, then the model is consistent with the existence of a short-range inhibitory interaction among like-oriented cells, as in the first competitive stage depicted in Figures 9 and 15.

If cells with the same preferred orientation but opposite directions of motion feed the on-cells and off-cells, respectively, of a dipole field (Figure 15), then opposite

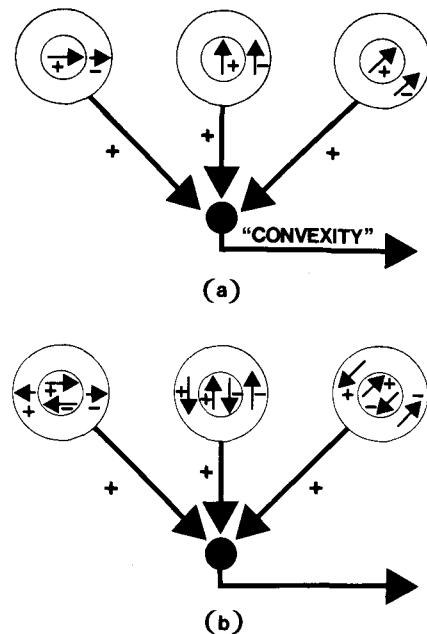

Figure 18. Variants of the Nakayama and Loomis (1974) model of "convexity" detecting units for extracting edges of 3-D objects for an observer translated through a rigid environment: (a) Units with like-preferred direction inhibit each other via an on-center off-surround interaction. All orientations at a given position summate their outputs to compute a "convexity" value that measures relative motion near figure-ground boundaries. (b) The model of (a) is augmented between opponent interactions between opposing directions of motion at each position.

directions of motion are also inhibitory, as in the model of Figure 18b. Thus, a first competitive stage which inputs to a second competitive stage that is organized as a gated dipole field can realize the spatial interactions required by the Nakayama and Loomis model. In addition to the interactions suggested by Nakayama and Loomis, such a dipole field contains interactions between orientations at each position, with mutually perpendicular orientations competing and sufficiently similar orientations cooperating to synthesize a best net orientation (Grossberg & Mingolla, 1987). Using these orientational interactions, nonoptimal random motions can be suppressed and a best local direction-of-motion chosen, thereby facilitating the detection of the figural boundary. In summary, the same general types of short-range competition and dipole field mechanisms which this article has linked to a wide range of data about static form perception may also play an important role in the neural circuits that process form-from-motion.

On the other hand, differences in the preprocessing of inputs to these form-extracting mechanisms can also be cited, and thereby clarify the need for separate anatomical circuits to carry out such preprocessing. For example, unlike the CC loop depicted in Figure 15, the competitive stages of a motion-detecting dipole field do not receive inputs from an OC filter whose receptive fields are independent of direction-of-contrast. Rather, the in-

puts to such a dipole field are derived from directionally sensitive cells (Barlow & Levick, 1965; Nakayama, 1985; Reichardt, 1961; van Santen & Sperling, 1984, 1985). Thus, BC System cells may input to parallel circuits for extracting different aspects of contrast-sensitive form information before these parallel circuits combine their outputs into a single completed boundary segmentation for further processing by the FC System into a unitary percept of form-and-color in depth. Illusory contours generated by inducers defined solely by spatiotemporal correlation (Prazdny, 1986) can be explained by such a network if its dipole field interacts with oriented bipole cells such as those that exist within the CC loop. Such a mechanism may also contribute to figure-ground segregation that is induced by motion contrast between object and background (Regan & Beverley, 1984).

### 33. Concluding Remarks

This article illustrates how the OC filter and the CC loop of the BC System can be used to analyze a wide variety of perceptual and neural data about monocular form perception. This unification permits these model circuits to be experimentally tested in multiple ways and thereby refined and modified by data focused upon this task. Although such modifications are to be expected, it would seem that the uncertainty principles that are resolved by these mechanisms will be part of the foundation of any future theory. Indeed, the very possibility of analyzing discrete boundaries and textures as well as continuous surfaces using a single computational theory suggests that these uncertainty principles have probed a basic level of brain design.

One of the main themes of the article is that psychophysical paradigms often activate mechanisms that control percepts of emergent form. The hypothesis that all boundaries are invisible within the BC System yet can nonetheless strongly influence the recognition of form suggests that the analysis of psychophysical data in terms only of the contrast sensitivity and nonlinear transduction of receptive field properties is insufficient in general.

Grossberg (1987b) builds upon this foundation by showing that these mechanisms of monocular form perception provide a computational foundation upon which a neural theory of 3-D form perception, including but not restricted to binocular percepts, can be built.

### REFERENCES

- ALBRIGHT, T. D., DESIMONE, R., & GROSS, C. G. (1984). Columnar organization of directionally sensitive cells in visual area MT of the macaque. *Journal of Neurophysiology*, *51*, 16-31.
- AREND, L. E., BUEHLER, J. N., & LOCKHEAD, G. R. (1971). Difference information in brightness perception. *Perception & Psychophysics*, *9*, 367-370.
- BADCOCK, D. R., & WESTHEIMER, G. (1985a). Spatial location and hyperacuity: The centre/surround localization contribution function has two substrates. *Vision Research*, *25*, 1259-1267.
- BADCOCK, D. R., & WESTHEIMER, G. (1985b). Spatial location and hyperacuity: Flank position within the centre and surround zones. *Spatial Vision*, *1*, 3-11.
- BARLOW, H. B., & LEVICK, W. R. (1965). The mechanism of directionally selective units in rabbit's retina. *Journal of Physiology*, *178*, 447-504.
- BECK, J., PRAZDNY, K., & ROSENFELD, A. (1983). A theory of textural segmentation. In J. Beck, B. Hope, & A. Rosenfeld (Eds.), *Human and machine vision*. New York: Academic Press.
- BECK, J., & SCHWARTZ, T. (1979). Vernier acuity with dot test objects. *Vision Research*, *19*, 313-319.
- BERGSTRÖM, S. S. (1966). A paradox in the perception of luminance gradients: I. *Scandinavian Journal of Psychology*, *7*, 209-224.
- BERGSTRÖM, S. S. (1967a). A paradox in the perception of luminance gradients: II. *Scandinavian Journal of Psychology*, *8*, 25-32.
- BERGSTRÖM, S. S. (1967b). A paradox in the perception of luminance gradients: III. *Scandinavian Journal of Psychology*, *8*, 33-37.
- BOYNTON, R. M., ESKEW, R. T., JR., & OLSON, C. X. (1985). Blue cones contribute to border distinctness. *Vision Research*, *25*, 1349-1352.
- BRADDICK, O. J. (1974). A short range process in apparent motion. *Vision Research*, *14*, 519-527.
- BREITMEYER, B. G. (1978). Disinhibition in metacontrast masking of vernier acuity targets: Sustained channels inhibit transient channels. *Vision Research*, *18*, 1401-1405.
- BREITMEYER, B. G. (1980). Unmasking visual masking: A look at the "why" behind the veil of the "how." *Psychological Review*, *87*, 52-69.
- CARPENTER, G. A., & GROSSBERG, S. (1986). Neural dynamics of category learning and recognition: Attention, memory consolidation, and amnesia. In J. Davis, R. Newburgh, & E. Wegman (Eds.), *Brain structure, learning, and memory* (AAAS Symposium Series).
- CARPENTER, G. A., & GROSSBERG, S. (1987). A massively parallel architecture for a self-organizing neural pattern recognition machine. *Computer Vision, Graphics, & Image Processing*, *37*, 54-115.
- CAVANAGH, P. (1985, November). *Reconstructing the third dimension: Interactions between color, texture, motion, binocular disparity, and shape*. Paper delivered at the Third Workshop on Human and Machine Vision, Boston.
- COHEN, M. A., & GROSSBERG, S. (1984a). Neural dynamics of brightness perception: Features, boundaries, diffusion, and resonance. *Perception & Psychophysics*, *36*, 428-456.
- COHEN, M. A., & GROSSBERG, S. (1984b). Some global properties of binocular resonances: Disparity matching, filling-in, and figure-ground synthesis. In P. Dodwell & T. Caelli (Eds.), *Figural synthesis*. Hillsdale, NJ: Erlbaum.
- COREN, S. (1983). When "filling-in" fails. *Behavioral & Brain Sciences*, *6*, 661-662.
- CORNISWEET, T. N. (1970). *Visual perception*. New York: Academic Press.
- DAY, R. H. (1983). Neon color spreading, partially delineated borders, and the formation of illusory contours. *Perception & Psychophysics*, *34*, 488-490.
- DESIMONE, R., SCHEIN, S. J., MORAN, J., & UNGERLEIDER, L. G. (1985). Contour, color, and shape analysis beyond the striate cortex. *Vision Research*, *25*, 441-452.
- DE VALOIS, R. L., ALBRECHT, D. G., & THORELL, L. G. (1982). Spatial frequency selectivity of cells in macaque visual cortex. *Vision Research*, *22*, 545-559.
- EIJMA, Y., REDIES, C., TAKAHASHI, S., & AKITA, M. (1984). The neon color effect in the Ehrenstein pattern: Dependence on wavelength and illuminance. *Vision Research*, *24*, 1719-1726.
- ELLIAS, S. A., & GROSSBERG, S. (1975). Pattern formation, contrast control, and oscillations in the short term memory of shunting on-center off-surround networks. *Biological Cybernetics*, *20*, 69-98.
- FROST, B. J., & NAKAYAMA, K. (1983). Single visual neurons code opposing motion independent of direction. *Science*, *220*, 744-745.
- GANZ, L. (1964). Lateral inhibition and the location of visual contours: An analysis of figural aftereffects. *Vision Research*, *4*, 465-481.

- GANZ, L., & DAY, R. H. (1965). An analysis of the satiation-fatigue mechanism in figural aftereffects. *American Journal of Psychology*, **78**, 345-361.
- GARNER, W. R. (1974). *The processing of information and structure*. Hillsdale, NJ: Erlbaum.
- GELLATLY, A. R. H. (1980). Perception of an illusory triangle with masked inducing figure. *Perception*, **9**, 599-602.
- GEORGEON, M. A., & SULLIVAN, G. D. (1975). Contrast constancy: Deblurring in human vision by spatial frequency channels. *Journal of Physiology* (London), **252**, 627-656.
- GERRITS, H. J. M., DE HAAN, B., & VENDRICK, A. J. H. (1966). Experiments with retinal stabilized images: Relations between the observations and neural data. *Vision Research*, **6**, 427-440.
- GERRITS, H. J. M., & TIMMERMAN, J. G. M. E. N. (1969). The filling-in process in patients with retinal scotomata. *Vision Research*, **9**, 439-442.
- GERRITS, H. J. M., & VENDRICK, A. J. H. (1970). Simultaneous contrast, filling-in process and information processing in man's visual system. *Experimental Brain Research*, **11**, 411-430.
- GOURAS, P., & KRÜGER, J. (1979). Responses of cells in foveal visual cortex of the monkey to pure color contrast. *Journal of Neurophysiology*, **42**, 850-860.
- GROSSBERG, S. (1973). Contour enhancement, short-term memory, and constancies in reverberating neural networks. *Studies in Applied Mathematics*, **52**, 217-257.
- GROSSBERG, S. (1976). Adaptive pattern classification and universal recoding: II. Feedback, expectation, olfaction, and illusions. *Biological Cybernetics*, **23**, 187-202.
- GROSSBERG, S. (1980). How does a brain build a cognitive code? *Psychological Review*, **87**, 1-51.
- GROSSBERG, S. (1981). Adaptive resonance in development, perception, and cognition. In S. Grossberg (Ed.), *Mathematical psychology and psychophysiology*. Providence, RI: American Mathematical Society.
- GROSSBERG, S. (1983a). Neural substrates of binocular form perception: Filtering, matching, diffusion, and resonance. In E. Basar, H. Flohr, H. Haken, & A. J. Mandell (Eds.), *Synergetics of the brain*. New York: Springer-Verlag.
- GROSSBERG, S. (1983b). The quantized geometry of visual space: The coherent computation of depth, form, and lightness. *Behavioral & Brain Sciences*, **6**, 625-692.
- GROSSBERG, S. (1984). Outline of a theory of brightness, color, and form perception. In E. Degreif & J. van Buggenhout (Eds.), *Trends in mathematical psychology*. Amsterdam: North-Holland.
- GROSSBERG, S. (1987a). *The adaptive brain: II. Vision, speech, language, and motor control*. Amsterdam: Elsevier/North-Holland.
- GROSSBERG, S. (1987b). Cortical dynamics of three-dimensional form, color, and brightness perception: II. Binocular theory. *Perception & Psychophysics*, **41**, 117-158.
- GROSSBERG, S., & LEVINE, D. S. (1975). Some developmental and attentional biases in the contrast enhancement and short term memory of recurrent neural networks. *Journal of Theoretical Biology*, **53**, 341-380.
- GROSSBERG, S., & MINGOLLA, E. (1985a). Neural dynamics of form perception: Boundary completion, illusory figures, and neon color spreading. *Psychological Review*, **92**, 173-211.
- GROSSBERG, S., & MINGOLLA, E. (1985b). Neural dynamics of perceptual grouping: Textures, boundaries, and emergent segmentations. *Perception & Psychophysics*, **38**, 141-171.
- GROSSBERG, S., & MINGOLLA, E. (1986a). Computer simulation of neural networks for perceptual psychology. *Behavior Research Methods, Instruments, & Computers*, **18**, 601-607.
- GROSSBERG, S., & MINGOLLA, E. (1986b). The role of illusory contours in visual segmentation. In G. Meyer & S. Petry (Eds.), *Proceedings of the international conference on illusory contours*. New York: Pergamon Press.
- GROSSBERG, S., & MINGOLLA, E. (1987). Neural dynamics of surface perception: Boundary webs, illuminants, and shape-from-shading. *Computer Vision, Graphics, & Image Processing*, **37**, 116-165.
- GROSSBERG, S., & STONE, G. (1986). Neural dynamics of word recognition and recall: Attentional priming, learning, and resonance. *Psychological Review*, **93**, 46-74.
- HAMADA, J. (1980, July). Antagonistic and non-antagonistic processes in the lightness perception. *Proceedings of the XXII International Conference of Psychology*, Leipzig.
- HEGDELUND, P. (1981). Receptive field organisation of complex cells in cat striate cortex. *Experimental Brain Research*, **42**, 99-107.
- HEGDELUND, P., & KREKLING, S. (1976). Edge dependent lightness distributions at different adaptation levels. *Vision Research*, **16**, 493-496.
- HELMHOLTZ, H. L. F. VON (1962). *Treatise on physiological optics* (J. P. C. Southall, Trans.). New York: Dover. (Original work published 1909)
- HENDRICKSON, A. E., HUNT, S. P., & WU, J.-Y. (1981). Immunocytochemical localization of glutamic acid decarboxylase in monkey striate cortex. *Nature*, **292**, 605-607.
- HERING, E. (1964). *Outlines of a theory of the light sense*. Cambridge, MA: Harvard University Press.
- HORTON, J. C., & HUBEL, D. H. (1981). Regular patchy distribution of cytochrome oxidase staining in primary visual cortex of macaque monkey. *Nature*, **292**, 762-764.
- HOUCK, M. R., & HOFFMAN, J. E. (1986). Conjunction of color and form without attention: Evidence from an orientation-contingent color aftereffect. *Journal of Experimental Psychology: Human Perception & Performance*, **12**, 186-199.
- HUBEL, D. H., & WIESEL, T. N. (1962). Receptive fields, binocular interaction and functional architecture in the cat's visual cortex. *Journal of Physiology*, **160**, 106-154.
- HUBEL, D. H., & WIESEL, T. N. (1968). Receptive fields and functional architectures of monkey striate cortex. *Journal of Physiology*, **195**, 215-243.
- HUBEL, D. H., & WIESEL, T. N. (1977). Functional architecture of macaque monkey visual cortex. *Proceedings of the Royal Society of London (B)*, **198**, 1-59.
- INGLE, D. J. (1985). The goldfish as a retinex animal. *Science*, **227**, 651-654.
- JULESZ, B. (1971). *Foundations of cyclopean perception*. Chicago: University of Chicago Press.
- JULESZ, B. (1985, November). *Recent advances in the texton theory of preattentive vision*. Paper delivered at the Third Workshop on Human and Machine Vision, Boston.
- KANIZSA, G. (1974). Contours without gradients or cognitive contours? *Italian Journal of Psychology*, **1**, 93-113.
- KAUFMAN, L. (1974). *Sight and mind: An introduction to visual perception*. New York: Oxford University Press.
- KAWABATA, N. (1984). Perception at the blind spot and similarity grouping. *Perception & Psychophysics*, **36**, 151-158.
- KENNEDY, J. M. (1978). Illusory contours and the ends of lines. *Perception*, **7**, 605-607.
- KENNEDY, J. M. (1979). Subjective contours, contrast, and assimilation. In C. F. Nodine & D. F. Fisher (Eds.), *Perception and pictorial representation*. New York: Praeger.
- KENNEDY, J. M. (1981). Illusory brightness and the ends of petals: Change in brightness without aid of stratification or assimilation effects. *Perception*, **10**, 583-585.
- KÖHLER, W., & WALLACH, H. (1944). Figural after-effects: An investigation of visual processes. *Proceedings of the American Philosophical Society*, **88**, 269-357.
- KRAUSKOPF, J. (1963). Effect of retinal image stabilization on the appearance of heterochromatic targets. *Journal of the Optical Society of America*, **53**, 741-744.
- LAND, E. H. (1977). The retinex theory of color vision. *Scientific American*, **237**, 108-128.
- LAND, E. H. (1983). Color vision and the natural image: III. Recent advances in retinex theory and some implications for cortical computations. *Proceedings of the National Academy of Sciences*, **80**, 5163-5169.
- LAPPIN, J. S., & BELL, H. H. (1976). The detection of coherence in moving random-dot patterns. *Vision Research*, **16**, 161-168.
- LIVINGSTONE, M. S., & HUBEL, D. H. (1982). Thalamic inputs to

- cytochrome oxidase-rich regions in monkey visual cortex. *Proceedings of the National Academy of Sciences*, **79**, 6098-6101.
- LIVINGSTONE, M. S., & HUBEL, D. H. (1984a). Anatomy and physiology of a color system in the primate visual cortex. *Journal of Neuroscience*, **4**, 309-356.
- LIVINGSTONE, M. S., & HUBEL, D. H. (1984b). Specificity of intrinsic connections in primate primary cortex. *Journal of Neuroscience*, **4**, 2830-2835.
- LUDVIGH, E. (1953). Direction sense of the eye. *American Journal of Ophthalmology*, **36**, 139-143.
- MAUNSELL, J. H. R., & VAN ESSEN, D. C. (1983). Response properties of single units in middle temporal visual area of the macaque. *Journal of Neurophysiology*, **49**, 1127-1147.
- NAKAYAMA, K. (1985). Biological image motion processing: A review. *Vision Research*, **25**, 625-660.
- NAKAYAMA, K., & LOOMIS, J. M. (1974). Optical velocity patterns, velocity-sensitive neurons, and space perception: A hypothesis. *Perception*, **3**, 63-80.
- NAKAYAMA, K., SILVERMAN, G. H., MACLEOD, D. I. A., & MULLIGAN, J. (1985). Sensitivity to shearing and compressive motion in random dots. *Perception*, **14**, 225-238.
- NAKAYAMA, K., & TYLER, C. W. (1981). Psychophysical isolation of movement sensitivity by removal of familiar position cues. *Vision Research*, **21**, 427-433.
- NEWSOME, W. T., GIZZI, M. S., & MOVSHON, J. A. (1983). Spatial and temporal properties of neurons in macaque MT. *Investigative Ophthalmology & Visual Science*, **24**, 106.
- O'BRIEN, V. (1958). Contour perception, illusion, and reality. *Journal of the Optical Society of America*, **48**, 112-119.
- PARKS, T. E. (1980). Subjective figures: Some unusual concomitant brightness effects. *Perception*, **9**, 239-241.
- PARKS, T. E., & MARKS, W. (1983). Sharp-edged vs. diffuse illusory circles: The effects of varying luminance. *Perception & Psychophysics*, **33**, 172-176.
- PETRY, S., HARBECK, A., CONWAY, J., & LEVEY, J. (1983). Stimulus determinants of brightness and distinctness of subjective contours. *Perception & Psychophysics*, **34**, 169-174.
- PICCOLINO, M., NEYTON, J., & GERSCHENFELD, H. M. (1984). Decrease of gap junction permeability induced by dopamine and cyclic adenosine 3':5'-monophosphate in horizontal cells of turtle retina. *Journal of Neuroscience*, **4**, 2477-2488.
- POLLACK, R. H. (1958). Figural after-effects: Quantitative studies of displacement. *Australian Journal of Psychology*, **10**, 269-277.
- POMERANTZ, J. R. (1981). Perceptual organization in information processing. In M. Kubovy & J. R. Pomerantz (Eds.), *Perceptual organization*. Hillsdale, NJ: Erlbaum.
- POMERANTZ, J. R. (1983). Global and local precedence: Selective attention in form and motion perception. *Journal of Experimental Psychology: General*, **112**, 516-540.
- POMERANTZ, J. R., & SCHWARTZBERG, S. D. (1975). Grouping by proximity: Selective attention measures. *Perception & Psychophysics*, **18**, 355-361.
- PRAZDNY, K. (1986). Illusory contours from inducers defined solely by spatiotemporal correlation. *Perception & Psychophysics*, **39**, 175-178.
- PRITCHARD, R. M. (1961). Stabilized images on the retina. *Scientific American*, **204**, 72-78.
- PRITCHARD, R. M., HERON, W., & HEBB, D. O. (1960). Visual perception approached by the method of stabilized images. *Canadian Journal of Psychology*, **14**, 67-77.
- QUINN, P. C. (1985). Suprathreshold contrast perception as a function of spatial frequency. *Perception & Psychophysics*, **38**, 408-414.
- REDIES, C., & SPILLMANN, L. (1981). The neon color effect in the Ehrenstein illusion. *Perception*, **10**, 667-681.
- REDIES, C., SPILLMANN, L., & KUNZ, K. (1984). Colored neon flanks and line gap enhancement. *Vision Research*, **24**, 1301-1309.
- REGAN, D., & BEVERLEY, K. I. (1984). Figure-ground segregation by motion contrast and by luminance contrast. *Journal of the Optical Society of America*, **1**, 433-442.
- REICHARDT, W. (1961). Autocorrelation, a principle for the evaluation of sensory information by the central nervous system. In W. A. Rosenblith (Ed.), *Sensory communication*. New York: Wiley.
- REYNOLDS, R. I. (1981). Perception of an illusory contour as a function of processing time. *Perception*, **10**, 107-115.
- RIGGS, L. A., RATLIFF, F., CORNSWEET, J. C., & CORNSWEET, T. N. (1953). The disappearance of steadily fixated visual test objects. *Journal of the Optical Society of America*, **43**, 495-501.
- SAGI, D., & HOCHSTEIN, S. (1984). The contrast dependence of spatial frequency channel interactions. *Vision Research*, **24**, 1357-1365.
- SAGI, D., & HOCHSTEIN, S. (1985). Lateral inhibition between spatially adjacent spatial-frequency channels? *Perception & Psychophysics*, **37**, 315-322.
- SCHILLER, P. H., FINLAY, B. L., & VOLMAN, S. F. (1976). Quantitative studies of single-cell properties in monkey striate cortex: I. spatiotemporal organization of receptive fields. *Journal of Neurophysiology*, **39**, 1288-1319.
- SKRZYPEK, J. (1984). Electrical coupling between horizontal cell bodies in the tiger salamander retina. *Vision Research*, **24**, 701-711.
- SPITZER, H., & HOCHSTEIN, S. (1985). A complex-cell receptive field model. *Journal of Neurophysiology*, **53**, 1266-1286.
- STEFURAK, D. L., & BOYNTON, R. M. (1986). Independence of memory for categorically different colors and shapes. *Perception & Psychophysics*, **39**, 164-174.
- TANAKA, M., LEE, B. B., & CREUTZFELDT, O. D. (1983). Spectral tuning and contour representation in area 17 of the awake monkey. In J. D. Mollon & L. T. Sharpe (Eds.), *Colour vision*. New York: Academic Press.
- TANSLEY, B. W., & BOYNTON, R. M. (1976). A line, not a space, represents visual distinctness of borders formed by different colors. *Science*, **191**, 954-957.
- TANSLEY, B. W., & BOYNTON, R. M. (1978). Chromatic border perception: The role of the red- and green-sensitivity cones. *Vision Research*, **18**, 683-697.
- TANSLEY, B. W., ROBERTSON, A. W., & MAUGHAN, K. E. (1983). Chromatic and achromatic border perception: A two-cone model accounts for suprathreshold border distinctness judgments and cortical pattern-evoked response amplitudes to the same stimuli. In J. D. Mollon & L. T. Sharpe (Eds.), *Colour vision*. New York: Academic Press.
- THORELL, L. G., DE VALOIS, R. L., & ALBRECHT, D. G. (1984). Spatial mapping of monkey V1 cells with pure color and luminance stimuli. *Vision Research*, **24**, 751-769.
- TODD, J. T., & AKERSTROM, R. (1986). *The perception of 3-D form from patterns of optical texture*. Manuscript in preparation.
- TODOROVIĆ, D. (1983). *Brightness perception and the Craik-O'Brien-Cornsweet effect*. Unpublished master's thesis. Storrs: University of Connecticut.
- TREISMAN, A. (1982). Perceptual grouping and attention in visual search for features and for objects. *Journal of Experimental Psychology: Human Perception & Performance*, **8**, 194-214.
- TREISMAN, A., & GELADE, G. (1980). A feature-integration theory of attention. *Cognitive Psychology*, **12**, 97-136.
- TREISMAN, A., & SCHMIDT, H. (1982). Illusory conjunctions in the perception of objects. *Cognitive Psychology*, **14**, 107-141.
- TREISMAN, A. M., SYKES, M., & GELADE, G. (1977). Selective attention and stimulus integration. In S. Dornic (Ed.), *Attention and performance VI* (pp. 333-361). Hillsdale, NJ: Erlbaum.
- USUI, S., MITARAI, G., & SAKAKIBARA, M. (1983). Discrete nonlinear reduction model for horizontal cell response in the carp retina. *Vision Research*, **23**, 413-420.
- VAN DEN BRINK, G., & KEEMINK, C. J. (1976). Luminance gradients and edge effects. *Vision Research*, **16**, 155-159.
- VAN SANTEN, J. P. H., & SPERLING, G. (1984). Temporal covariance model of human motion perception. *Journal of the Optical Society of America*, **1**, 451-473.
- VAN SANTEN, J. P. H., & SPERLING, G. (1985). Elaborated Reichardt detectors. *Journal of the Optical Society of America*, **2**, 300-321.
- VAN TUIJL, H. F. J. M. (1975). A new visual illusion: Neonlike color spreading and complementary color induction between subjective contours. *Acta Psychologica*, **39**, 441-445.
- VAN TUIJL, H. F. J. M., & DE WEERT, C. M. M. (1979). Sensory con-

- ditions for the occurrence of the neon spreading illusion. *Perception*, **8**, 211-215.
- VAN TULL, H. F. J. M., & LEEUWENBERG, E. L. J. (1979). Neon color spreading and structural information measures. *Perception & Psychophysics*, **25**, 269-284.
- VON DER HEYDT, R., PETERHANS, E., & BAUMGARTNER, G. (1984). Illusory contours and cortical neuron responses. *Science*, **224**, 1260-1262.
- WATT, R. J., & CAMPBELL, F. W. (1985). Vernier acuity: Interactions between length effects and gaps when orientation cues are eliminated. *Spatial Vision*, **1**, 31-38.
- WESTHEIMER, G. (1981). Visual hyperacuity. *Progress in Sensory Physiology*, **1**, 1-30.
- WESTHEIMER, G., & MCKEE, S. P. (1977). Integration regions for visual hyperacuity. *Vision Research*, **17**, 89-93.
- WILSON, H. R. (1986). Responses of spatial mechanisms can explain hyperacuity. *Vision Research*, **26**, 453-469.
- WILSON, H. R., & BERGEN, J. R. (1979). A four mechanism model for threshold spatial vision. *Vision Research*, **19**, 19-32.
- YARBUS, A. L. (1967). *Eye movements and vision*. New York: Plenum Press.
- ZEKI, S. (1974a). Cells responding to changing image size and disparity in the cortex of the rhesus monkey. *Journal of Physiology (London)*, **242**, 827-841.
- ZEKI, S. (1974b). Functional organization of a visual area in the posterior bank of the superior temporal sulcus of the rhesus monkey. *Journal of Physiology (London)*, **236**, 549-573.
- ZEKI, S. (1983a). Colour coding in the cerebral cortex: The reaction of cells in monkey visual cortex to wavelengths and colours. *Neuroscience*, **9**, 741-765.
- ZEKI, S. (1983b). Colour coding in the cerebral cortex: The responses of wavelength-sensitive and colour coded cells in monkey visual cortex to changes in wavelength composition. *Neuroscience*, **9**, 767-791.

(Manuscript received December 19, 1985;  
revision accepted for publication November 4, 1986.)