



Review:

Wearable devices and IoT applications for symptom detection, infection tracking, and diffusion containment of the COVID-19 pandemic: a survey

Roberto DE FAZIO¹, Nicola Ivan GIANNOCARO¹, Miguel CARRASCO²,
 Ramiro VELAZQUEZ³, Paolo VISCONTI^{‡1}

¹Department of Innovation Engineering, University of Salento, Lecce 73100, Italy

²Facultad de Ingeniería y Ciencias, Universidad Adolfo Ibáñez, Peñalolén, Santiago 7941169, Chile

³Facultad de Ingeniería, Universidad Panamericana, Aguascalientes 20290, Mexico

E-mail: roberto.defazio@unisalento.it; ivan.giannocaro@unisalento.it; miguel.carrasco@uai.cl;
 rvelazquez@up.edu.mx; paolo.visconti@unisalento.it

Received Feb. 15, 2021; Revision accepted June 7, 2021; Crosschecked Oct. 9, 2021

Abstract: Until a safe and effective vaccine to fight the SARS-CoV-2 virus is developed and available for the global population, preventive measures, such as wearable tracking and monitoring systems supported by Internet of Things (IoT) infrastructures, are valuable tools for containing the pandemic. In this review paper we analyze innovative wearable systems for limiting the virus spread, early detection of the first symptoms of the coronavirus disease COVID-19 infection, and remote monitoring of the health conditions of infected patients during the quarantine. The attention is focused on systems allowing quick user screening through ready-to-use hardware and software components. Such sensor-based systems monitor the principal vital signs, detect symptoms related to COVID-19 early, and alert patients and medical staff. Novel wearable devices for complying with social distancing rules and limiting interpersonal contagion (such as smart masks) are investigated and analyzed. In addition, an overview of implantable devices for monitoring the effects of COVID-19 on the cardiovascular system is presented. Then we report an overview of tracing strategies and technologies for containing the COVID-19 pandemic based on IoT technologies, wearable devices, and cloud computing. In detail, we demonstrate the potential of radio frequency based signal technology, including Bluetooth Low Energy (BLE), Wi-Fi, and radio frequency identification (RFID), often combined with Apps and cloud technology. Finally, critical analysis and comparisons of the different discussed solutions are presented, highlighting their potential and providing new insights for developing innovative tools for facing future pandemics.

Key words: Wearable devices; IoT health-monitoring applications; Medical sensors; COVID-19 pandemic; Symptom detection
<https://doi.org/10.1631/FITEE.2100085> **CLC number:** TP212.9

1 Introduction

Globally, as of 11 February 2021, there have been more than 106 990 000 confirmed cases of coronavirus disease COVID-19, including more than 2 347 000 deaths reported by the World Health

Organization (WHO). The virus has been contracted on almost every continent (Fig. 1). Furthermore, the pandemic is causing severe damage to the economic systems of each country. Fig. 2 shows the gross domestic product (GDP) growth rate of the European Union (EU) countries and the related forecasts for 2021. In 2020, all the nations belonging to the Euro area suffered from reduced GDP between 4% and 10% (Fig. 2a). However, forecasts for 2021 indicate a strong rebound in GDP with a mean increase higher

[‡] Corresponding author

ORCID: Roberto DE FAZIO, <https://orcid.org/0000-0003-0893-138X>; Paolo VISCONTI, <https://orcid.org/0000-0002-4058-4042>

© Zhejiang University Press 2021

than 4% (Fig. 2b). The virus continues to affect every region of the world, and while some countries appear to have primarily controlled the virus, others are experiencing high and rising infection rates. To reduce transmission and control the epidemic as soon as possible, the scientific community focuses on different critical activities (UK Health Security Agency, 2020). In this context, technology constitutes a powerful tool for remote monitoring of user parameters, determining health issues, and making decisions about the most suitable therapy for improving the user’s lifestyle (Visconti et al., 2018, 2019; Gaetani et al., 2019). In particular, the scientific community is developing contact tracking processes. Contact tracing is the process of identifying, assessing,

and managing people who have been exposed to a disease to prevent onward transmission. Contact tracing for COVID-19 requires identifying persons who may have been exposed to COVID-19 and following them daily for 14 d from the last point of exposure.

The process is challenging to put into practice because it takes a long time and, above all, because virus can be transmitted between people without evident symptoms. Therefore, remote patient health status diagnostic and monitoring methods become fundamental to reduce the virus’s spread (Donaghy et al., 2019; CDC, 2020). The diagnostic and monitoring methods involve considerable data processing difficulties, particularly regarding data security and privacy (Rights Office for Civil, 2020). Wearable devices have an enormous potential to curb the spread of the COVID-19 pandemic and other infective diseases. Several efforts have been made in the last months by the scientific community and companies to develop advanced, portable, low-power, and multifunctional wearable devices to detect the onset of the symptoms of COVID-19 diseases, such as fever, cough, reduced blood oxygenation (i.e., low SpO₂), and increased heart-rate variability (HRV), and thus intervene more quickly before the deterioration of the patient’s physical condition.

In this paper we investigate the different Internet of Things (IoT) solutions and wearable sensing devices reported on the market and in the scientific literature for early detection of symptoms of COVID-19. Specifically, wearable devices and the IoT system are currently employed by hundreds of millions of people worldwide to detect different biophysical and environmental parameters, such as body temperature, heart rate (HR), SpO₂, and respiration rate (RR). These devices, supported by cloud platforms and mobile applications, can process the acquired information continuously and in real time to detect the early stages of the infection. We provide an overview of the different wearable solutions for complying with social distancing rules; particularly, the main countermeasures for reducing the spreading of COVID-19 are the use of the mask and social distancing. Several solutions have been developed to help workers check and maintain social distancing in the workplace, thus allowing the continuation of production activities (European Centre for Disease Prevention and Control, 2020).

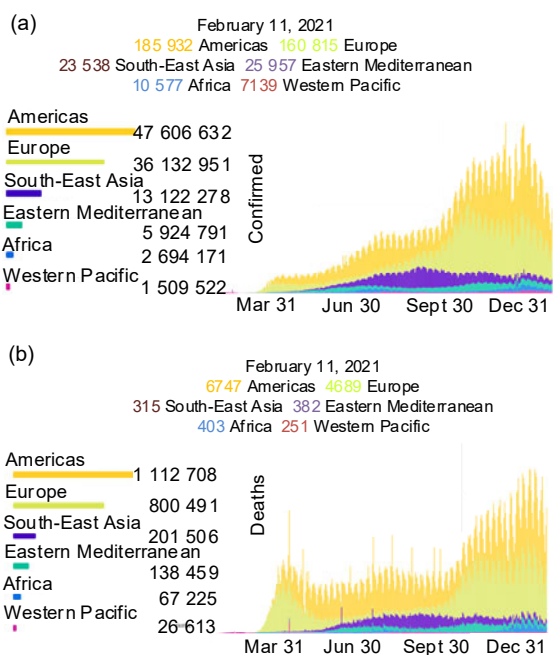

Fig. 1 COVID-19 infections (a) and deaths (b) trends by continent (WHO, 2020)

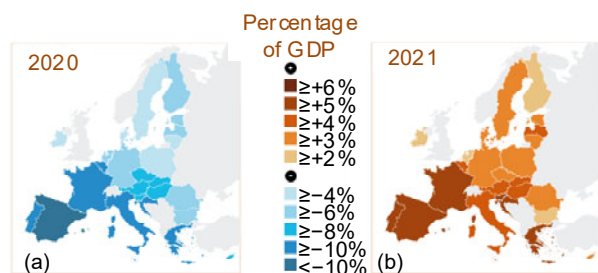

Fig. 2 Geographic maps of the gross domestic product (GDP) growth rate of the European Union countries in 2020 (a) and as expected for 2021 (b) (European Commission, 2020; WHO, 2020)

Different models of smart masks have been considered and analyzed as an essential tool for continuing control of pandemic diffusion, as suggested by the WHO guidelines.

Recent studies have demonstrated a correlation between cardiovascular diseases and COVID-19, so we have investigated an implantable solution for remotely monitoring heart conditions. State-of-the-art tracing systems for containing the COVID-19 pandemic are also reported. In fact, companies and state governments introduced tracing applications for tracking citizens' movements from the first months of the pandemic, and can thus rebuild the contagion chain once a user is found to be infected, limiting the pandemic's spread. Finally, we apply critical analysis and performance comparisons to the discussed applications and point out the advantages, limitations, and future potentials for obtaining the tools that are necessary to face future pandemics.

To our knowledge, the current scientific literature does not include a review work that is as comprehensive and in-depth as this paper, which concerns not only prototypes derived in scientific work but also commercial and post-development devices for commercialization. In particular, this study considers a wide range of last-generation wearable and portable devices reported in the scientific literature and on the market to detect the symptoms of COVID-19, remotely monitor infected patients, trace the contagion chain, and follow the patient's post-illness status. Furthermore, novel IoT tracing systems, also supported by wearable devices, are deeply explored, focusing on the numerous solutions proposed by research centers and governmental bodies during the two years 2020–2021 to contain the COVID-19 pandemic. The aim is to cover as many technologies and solutions as possible to provide the reader with a comprehensive view of the treated topics. Finally, critical analysis of the different devices and strategies is reported, providing a comparison to highlight potential benefits and shortcomings to help develop the tools to tackle future pandemics; we consider this one of the main contributions offered by this work.

This review paper is arranged as follows: Section 2 covers an overview of different IoT solutions and wearable sensing devices for detecting the first symptoms of COVID-19. In Section 2.1, we discuss the different types of wearable devices and

sensors to detect COVID-19 symptoms. In Section 2.2, various models of smart masks for safety and detection purposes are analyzed. Section 2.3 presents an analysis of implantable devices for detecting the effects of COVID-19 on the human body. Section 3 is an overview of wearable solutions to help users maintain social distancing in the workplace. Section 4 presents the state of the art in tracing systems for containing COVID-19. In Section 5, we provide performance comparisons and critical analysis of the devices, technologies, and architectures described in the previous sections. Finally, Section 6 concludes the paper.

2 IoT solutions and wearable sensing devices to tackle the COVID-19 pandemic

2.1 Wearable devices and sensors to detect COVID-19 symptoms

Here we explore innovative wearable solutions (reported in scientific works) that are aimed at detecting the onset of the first symptoms of COVID-19, such as fever, cough, respiratory issues, and low blood oxygenation, and innovative sensors for detecting infected people in a rapid and non-invasive manner. Different solutions have been proposed in the scientific literature for remote tracking and monitoring of patient vital signs to detect worsening of their conditions early in the disease process (Chung et al., 2020; Greenhalgh et al., 2020; Menni et al., 2020).

Body temperature is the primary indicator of possible contagion by the COVID-19 virus; for body temperature higher than 37.5 °C, self-quarantine is suggested to the patient to avoid an eventual diffusion of the disease, and a reverse transcriptase-polymerase chain reaction (RT-PCR) test is performed. Therefore, solutions for remotely monitoring body temperature have been presented on the market or proposed in scientific works. Mondal et al. (2020) proposed a low-cost and lightweight solution for remotely monitoring body temperature, ensuring 98% accuracy. The resulting wearable design is comfortable and can be integrated into our daily lives amid the current COVID-19 pandemic. In addition, Chen XY et al. (2020) developed an in-ear thermometer for monitoring body temperature with smartphone support. Also, several watch-type thermometers are present on

the market, allowing continuous monitoring and comfort. Examples of such devices are the iFever, iTherm, and Tadsafe™ wrist thermometers, all equipped with Bluetooth connectivity, remotely monitoring the patient temperature and suitable for infants (iFever, 2018; Indiegogo, 2018; TADSAFE, 2019). Conversely, plaster-type thermometers represent a practical solution for continuously detecting neonate body temperature without staff carrying the device. Fever Scout (Fig. 3a), TempTraq (Fig. 3b), and Tucky (Fig. 3c) are examples of these devices, representing hand-free, easy-to-use, reusable solutions to monitor body temperature (VivaLNK, 2020; E-takescare, 2021; TempTraq, 2021).



Fig. 3 Example of plaster-type thermometers: (a) Fever Scout device, manufactured by VivaLNK Co. (VivaLNK, 2020); (b) TempTraq thermometer, manufactured by Blue Spark Technologies, Inc. (TempTraq, 2021); (c) Tucky wearable thermometer, produced by E-takescare Co. (E-takescare, 2021)

Impaired respiratory activity induced by COVID-19 also significantly affects cardiovascular activity. Thus, the HR is a good indicator of the body's physiological stress caused by the viral infection. Wearable devices constitute an effective, convenient, and handy solution for monitoring the HR of COVID-19 patients. Patil et al. (2019) developed a wireless device to continuously monitor heart activity. The system acquires and processes the data from a photoplethysmography (PPG) sensor and provides short message service (SMS) to medical staff and parents for quick rescue. Furthermore, Sharma et al. (2019) introduced a novel acoustic sensing method for cardiac monitoring in wearable devices. The technique is based on detecting heart sounds and the pulse waves from the radial artery in the wrist. Shahshahani et al. (2017) introduced a non-invasive ultrasound technology to detect heart motions and thus determine the HR. The developed wearable prototype detects the time-of-flight (TOF) and amplitude of an ultrasound signal reflected from the

chest. Furthermore, Quy et al. (2019) proposed a wrist-type wearable device to monitor the HR based on highly sensitive and ultrastable piezoresistive pressure sensors. This device includes a multi-layer graphite/polydimethylsiloxane composite structure.

Because the main consequence of COVID-19 is bilateral pneumonia, which compromises the respiratory capacity of the infected patient, the monitoring of SpO₂ is the primary indicator for establishing severity and advancement of COVID-19.

Xue et al. (2015) developed a wearable device to continuously monitor SpO₂ and temperature. The system includes an AFE44x0 chip for implementing the pulse-oximeter, with the sensing probe applied to the earlobes. Son et al. (2017) used a wearable device for SpO₂ measurement to monitor the user's health condition in real time. The developed sensing unit is based on the reflective PPG principle, and detects the reflected light emitted by infrared and red light emitting diodes (LEDs) using a photodiode.

Similarly, Adiputra et al. (2018) developed a low-power and low-cost device to monitor SpO₂ and HR. Acquired data are wirelessly transmitted using a network gateway IoT application, where the data are displayed, stored, and analyzed. Chen QG and Tang (2020) developed a wearable system to monitor blood oxygenation from the PPG signal and proposed a new adaptive cancellation algorithm based on adaptive filtering to delete motion-induced interference.

RR is another fundamental indicator for establishing a user's health status and can suggest the onset of a respiratory disease such as COVID-19. Chu et al. (2019) developed a disposable respiration sensor in a typical patch form factor. This sensor includes a strain gauge that converts chest movements due to breathing into a resistance variation, which is processed to extract the RR data. The RR can be estimated from the acceleration data acquired by a wearable device. Hung (2017) demonstrated that chest-acceleration data can provide a reliable estimation of the waveform and the RR. This method can detect some respiratory disease, such as obstructive apnea. Tadi et al. (2014) presented a seismocardiography (SCG) method based on accelerometer data for determining both the RR and information related to the rest phase during the cardiac cycle obtained from myocardial movements (atrial and ventricular). The obtained results demonstrated a high linear correlation between the derived measures of RR and

myocardial movements with reference ones acquired by an electrocardiogram (ECG) and respiration belt. A research group of the Department of Engineering, University of Cambridge used small conductive fibers realized by 3D printing to sense breathing in a tridimensional modality (Wang et al., 2020) (Fig. 4); the corresponding process is called inflight fiber printing (iFP). The researchers have developed a micro-scale 3D printed composite fiber composed of a silver core covered by a thin film of PEDOT:PSS (i.e., poly(3,4-ethylenedioxythiophene) polystyrene sulfonate) conductive polymer. These sensors are lightweight, cheap, small, and can be easily integrated into fabric. Because the fibers are fully biocompatible and have dimensions compatible with biological cells, they can deploy biological cells. Alternatively, RR can be assessed by monitoring body temperature variations, humidity, and CO₂ using wearable devices (Liu HP et al., 2019). In addition, the RR can be determined using respiratory airflow detected acoustic transducers (microphone) applied in different areas of the human body, such as the mouth, nose, and ear canal.

PMD Solutions has proposed RespiSense, “a wearable device that continuously monitors the RR and has high tolerance to the user’s motion” (PMD Solutions, 2021). The device uses piezoelectric thin-film sensors arranged in an array to measure the deformation and angles of the abdominal wall that occur during respiration and to convert them into an electrical signal. RespiSense detects the sensor

signals and determines the mean RR during a 15-min time interval using a proprietary algorithm, and discards insignificant data. Comparing the measures provided by the device with those of the capnography system, the experimental results demonstrated a 95% confidence level between $\pm 2\%$, confirming the device accuracy in the considered RR range (i.e., 9–21 BPM, BPM=breaths per minute).

The data provided by an ordinary smartwatch can also be used to detect preliminary symptoms of COVID-19. Specifically, Mishra et al. (2020) presented a smartphone App that collects the smartphone and activity tracker data, along with self-reported information and diagnostic test results, to identify symptoms that are indicative of COVID-19 disease onset. They demonstrated that considering a combination of sensor and self-provided data, the developed model produces an area under the curve (AUC) equal to 0.8 in discerning positive from negative symptomatic patients, which is more performant than the model that considers only the symptoms (AUC=0.71, and impulsive relapse questionnaire (IRQ) in the range of 0.63–0.79). The performance of these techniques can be improved by collecting data from other low-cost multifunctional wearable devices. Also, the availability of innovative sensors like wristbands, tattoos, textiles, patches, and rings can aid in detecting biophysical and environmental parameters. For instance, Moreddu et al. (2020) developed a contact lens sensor to detect analytes (i.e., glucose, proteins, nitrite ions, etc.) in the tears to

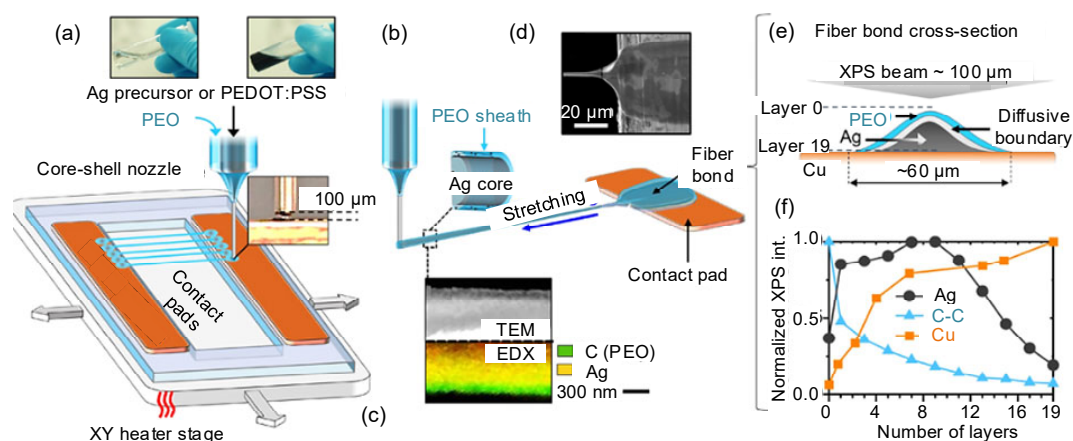

Fig. 4 Schematic representation of the inflight fiber printing (iFP) process (a), schematic view of the iFP fibers’ deposition (b), transmission electron microscope (TEM) and electron diffraction spectroscopy (EDX) images of a single iFP fiber (c), scanning electron microscopy (SEM) image depicting fiber bond with a contact pad (d) and related cross-section (e), and X-ray photoelectron spectroscopy (XPS) profiling on the Ag fiber bond (f)

Reprinted from Wang et al. (2020), Copyright 2020, with permission from the authors, licensed under CC BY 4.0

monitor the ocular health both in clinics and at point-of-care settings. The lens includes microfluidic channels in the form of a ring and four lateral branches realized by laser ablation and biosensors placed in the branch ends. The experimental tests, carried out using synthetic tears and colorimetric detection by a MATLAB algorithm executed by a smartphone, demonstrated rapid and accurate detection of considered analytes. In addition, smart tattoos implanted under the skin are an efficient and practical solution for monitoring the blood glucose level. These tattoos are composed of an array of biosensors implanted inside the subcutaneous tissue detecting the local glucose change in the interstitial fluid (Meetoo et al., 2019). If the glucose level overcomes a predetermined threshold, color changes are produced which are detectable using a non-invasive optical reader; these technologies can be easily extended to detect other analytes, like the COVID-19 virus. Also, Mojsoska et al. (2021) proposed a proof-of-concept patch-based COVID-19 assay to detect the SARS-CoV-2 spike surface protein. The patch is based on a working graphene electrode that is engineered with the spike protein antibody; the variation in the cyclic voltammogram of the ferri/ferrocyanide solution after the spike protein-antibody binding is ascribable to a change of current in $[\text{Fe}(\text{CN})_6]^{3-/4-}$, which increases the spike protein concentration. The experimental tests demonstrated that the sensor's detection is limited to 260 nmol/L.

Jeong H et al. (2020) described a tracking and monitoring device developed by researchers at Northwestern University and Chicago's Shirley Ryan AbilityLab. They proposed a soft, flexible, wirelessly connected, and thin wearable device with the size of a postage stamp placed just below the suprasternal notch (Fig. 5). The device produces continuous streams of data and uses artificial intelligence to discover life-saving information and track patients. Precisely, it continuously measures and analyzes cough and chest movements (which indicate labored or irregular breathing), breath sounds, HR, and body temperature (including fever) in ways that are impossible for traditional monitoring systems. After these measurements, it transmits the data wirelessly to a health insurance portability and accountability act (HIPAA) protected cloud, where computer algorithms produce custom graphical summaries to make the monitoring even more immediate and easy.



Fig. 5 Demonstration of the application of the device on the skin

Reprinted from Jeong H et al. (2020), Copyright 2020, with permission from the authors, licensed under CC BY 4.0

A team at Australia's Central Queensland University used a "WHOOOP wristwatch to detect the early warning signs of COVID-19" (Labs DI, 2020; Miller et al., 2020). Specifically, the team analyzed RR changes to establish the risk of COVID-19 infections and developed a model to determine the probability of COVID-19 positivity as a function of the RR during sleep. Experimental tests have demonstrated that the proposed model can identify 80% of COVID-19-positive users after a two-day training phase.

Hassantabar et al. (2020) proposed a framework called CovidDeep, which uses a deep neural network (DNN) to evaluate the data provided by commercial wearable devices to determine positive COVID-19 cases. The data were provided by wearable devices and questionnaires compiled by the user and were available on a suitable smartphone application. A DNN was trained with data collected by 87 people and achieved 98.1% accuracy in discerning positive COVID-19 cases. El-Rashidy et al. (2020) introduced a fog network framework to fill the gap between medical technologies and the healthcare system to detect users affected by COVID-19. The proposed architecture integrates wearable devices, cloud computing, fog computing, and clinical decision support systems to obtain an efficient model to identify infected individuals. The authors developed a classifier that is based on a deep convolutional neural network (CNN) applied to X-rays of the chest to identify a patient as infected or normal by assigning weights to the different aspects/features induced by COVID-19 on the lungs. The proposed end-to-end framework allows real-time monitoring of the patient at home and early detection of infected individuals, so

their contacts can be tracked to break the contagion chain.

Wearable solutions for remotely monitoring the user's biophysical condition are receiving great attention from the scientific community and companies during the COVID-19 pandemic, because they permit non-critical patients to be moved away from hospital facilities, ensuring a satisfactory level of assistance (Fig. 6a). In this field, LifeSignals Co. has developed "a single-use biosensor for the COVID-19 pandemic to monitor a patient's main vital signs" (LifeSignals, 2020). The device has to be applied to the user's chest and detects movement, the heart's electrical activity with a two-channel ECG, blood oxygenation, and blood pressure (BP); the smart patch is waterproof, resilient, and lightweight; these are essential considering the application. Acquired data are wirelessly transmitted through a gateway to a cloud platform where the data are displayed and analyzed for different monitored patients. Deterioration of respiration or heart parameters triggers an alert, allowing early intervention of the medical staff.

Celsius has presented a wearable thermometer, placed at the armpit, to remotely monitor the user's temperature (Celsius, 2020). The device is Bluetooth-connected with a mobile App, which is synchronized with an intelligent platform that integrates a custom algorithm that accurately determines the body temperature. "The smart thermometer is designed for hospital environments, where multiple devices are connected to a central dashboard, allowing medical operators to monitor the temperature of numerous patients and in real time." The dashboard warns the medical staff if the temperature overcomes a set threshold over a short time interval (Fig. 6b).

Another wearable device for monitoring and tracking the patient's health conditions is the ECGAlert manufactured by Savvy Co. (ECG Alert, 2020) (Fig. 7a). It can automatically detect atrial fibrillation in COVID-19 patients, usually from some particular treatments like with hydroxychloroquine and azithromycin. Automatic and early detection is of paramount importance in these cases to ensure that doctors can administer timely treatments. The smart Oura Ring continuously monitors body temperature, allowing early detection of COVID-19 cases, leading to earlier insolation and testing to curb the spread of

the infectious disease (Oura, 2020). "The Gen2 Oura Ring uses infrared (IR) LED technology, and does not include SPO₂ monitoring, whereas the Gen3 Oura Ring includes red and green LED, in addition to the IR one, and will include SPO₂ as a future feature."



Fig. 6 Smart patch developed by LifeSignals Co. for monitoring patients' main vital signs (a) and a wearable thermometer "Celsius" produced by the Smartr Health company, placed in the armpit, to remotely monitor the user's temperature (b) (Celsius, 2020)



Fig. 7 ECG Alert wearable device (ECG Alert, 2020) (a) and WorkSafr wearable device (Cognet Things Inc., 2020) (b)

Another significant value that is monitored is the HRV. Not everyone is aware of this value, but it is essential in describing a person's state of stress or well-being. HRV is closely related to the autonomic nervous system, and its variation is fundamental for proper functioning of the parasympathetic system. A low HRV indicates low reactivity of the parasympathetic system and a longer recovery from physical and emotional exertion. Cognet Things proposes the COVID-19 WorkSafr Tracker, "a smart wearable device with multi-faceted solutions for COVID-19 tracking and tracing, to improve the patient safety and provide actionable insights" (Fig. 7b) (Cognet Things Inc., 2020). "The device allows real-time warnings, monitoring, and incident reporting, essential in monitoring COVID-19 patients and location tracking and tracing with geo-fencing. The COVID-19 Patient

Tracker automatically detects temperature, HR, and blood oxygen saturation automatically.”

8 West has proposed the COVID-19 remote early warning (CREW) system to aid healthcare staff who works on the frontline (8 West, 2020). The CREW system includes: (1) a wearable digital thermometer sensor for detecting body temperature, (2) a sensor platform, e.g., smartphone, smartwatch, or wearable IoT device running the CREW App, and (3) a cloud-based server running the CREW system that monitors the incoming data and generates automatic alarms if temperature thresholds are breached.

The CREW system regularly acquires body temperature and triggers alerts if a temperature threshold has been breached. The system consists of sensors, smart devices, and a cloud-based monitoring and alerting system. The system has been tested by the medical staff of the Emergency Department of Cork University Hospital (CUH). By integrating wearable technologies and collecting data from different sensors in an intelligent and scalable monitoring solution, 8 West believes that a solution can reassure frontline healthcare workers and provide useful data to hospitals and treatment centers related to their valued staff (Fig. 8).

The Vital Patch, manufactured by VitalConnect Co., is a wearable device for remotely monitoring the health condition of the patient who wears it (MediBioSense, 2020) (Fig. 9a). The device detects, in real time, eight biophysical parameters (body temperature, HR, HRV, body posture, RR, single ECG, fall-detection, activity level), and wirelessly transmits the acquired information to the patient-monitoring platform for storage and analysis. The self-isolation and social distancing related to the COVID-19 pandemic are inducing several psychological problems, like high stress level, anxiety, and panic attacks, which are just as insidious as the virus consequences. Lief Therapeutics proposed a wearable device, called Lief Rx, which “monitors HR and HRV, extracts information about psychophysical conditions, and provides biofeedback to the user to reduce their anxiety” (Lief Therapeutics, 2019). Similarly, Skiin has presented a wide range of garments (underwear, bras, shirts, and sleep masks) equipped with several sensors to continuously monitor vital signs, like sleep quality, activity, temperature, and ECG levels (Fig. 9b).



Fig. 8 Overview of the main components included in the CREW system: (a) sensor platform; (b) wearable digital thermometer sensor; (c) cloud platform (8 West, 2020)

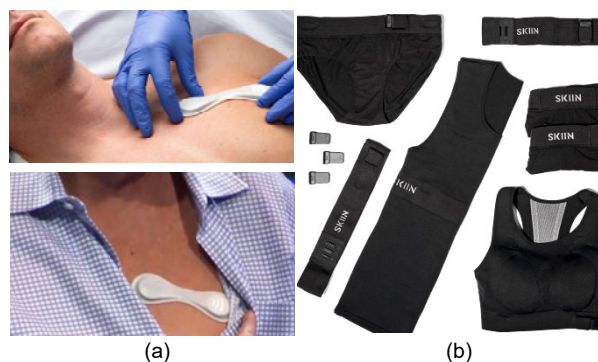

Fig. 9 (a) Vital Patch, manufactured by VitalConnect Co., monitors biophysical parameters (MediBioSense, 2020); (b) the smart garment, produced by Skiin, has different sensors to monitor the user’s vital signs (Skiin, 2019)

2.2 Overview of innovative masks for limiting the spread of COVID-19

Currently, several innovative masks have been developed and proposed for the market that can perform their filtering function and detect biophysical parameters. AirPoP Co. patented the Active+ Halo mask, “which consists of a flexible filtering membrane that adapts to the user’s face ensuring a 99.3% particle filtration efficiency (PFE) and 99.9% bacterial filtration efficiency (BFE)” (AirPoP Co., 2020). The innovative mask integrates a sensor array to detect breath parameters and send them to a mobile App, and an onboard LED signals the breath rate. Also, LG Group is developing the PuriCare Wearable Air, “a smart mask equipped with two high-performance filters that capture up to 99.5% of virus, bacteria, and particles” (Fig. 10a) (LG Group, 2020). Thanks to a double fan and an RR sensor, the smart mask provides fresh and purified air to the user; the

sensor detects all the phases of the RR and the respiration volume, and regulates the fan speed accordingly. The fan automatically accelerates to support air inhalation and decelerates to reduce resistance during expiration. The mask case also includes a wireless recharging system and ultraviolet (UV) LEDs to eliminate germs and viruses.

Similarly, Razer has created project Hazel, “a smart mask that ensures N95 medical-grade respiration protection” (Fig. 10b) (Razer, 2020). It includes an active ventilation system that adjusts incoming airflow as a function of the respiration parameters detected by a built-in microphone and speaker, which are also used by the mask to understand when the user wears the mask. Also, in this case, a cover is equipped with a wireless recharging system and UV lamp for the auto-sterilization function to kill bacteria and viruses. Also, a University of Leicester research team developed a 3D printed face mask that can be created in just 30 min, and is thus suitable for mass production. It must be printed using Copper3D filament, that is, a polylactic acid (PLA) filament loaded with copper nanoparticles (NPs), which make the mask antimicrobial, antiviral, reusable, and eco-sustainable (NanoHack 3D, 2020).



Fig. 10 PuriCare wearable air smart mask developed by LG Group (LG Group, 2020) (a) and a smart mask manufactured by Razer and equipped with an automatic ventilation system (Razer, 2020) (b)

Furthermore, Xiaomi has requested a patent for “the Xiaomi Purely Mask equipped with several sensors for monitoring respiration status in real time” (Xiaomi, 2020) (Fig. 11a). Thanks to integrated sensors, “the mask measures the amount of absorbed pollutant, the air quality index (AQI), RR, and the user’s movement using integrated accelerometers and

gyroscopes to determine variations of lung capacity. The acquired data are preprocessed by an onboard processing unit and then transmitted to a suitable mobile application where the data are displayed, processed, and stored.”

The Guardian G-Volt mask, produced by LIGC Applications, is “a novel graphene-based filter composed of a laser-induced graphene (LIG) layer and a graphene foam obtained by CO₂ laser cutting technique” (Dezeen, 2019; Stanford et al., 2019). The resulting filter can quickly reach a temperature higher than 300 °C, exploiting the Joule-heating mechanism, self-sterilizing the mask. The thermal stability and relatively high surface of the LIG filter make it very efficient in reducing infection in hospital settings. The G-Volt mask features high filtering efficiency for particles over 0.3 μm and 80% for smaller particles (Fig. 11b). “The mask is periodically connected to a portable power bank to destroy bacteria and virus deposited on the surface, allowing its complete sterilization.”

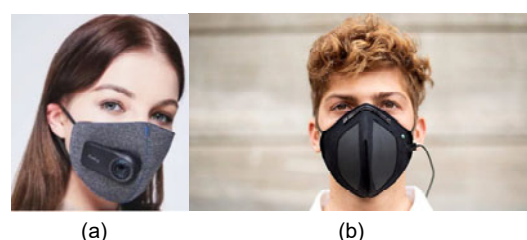

Fig. 11 Xiaomi smart mask, produced by Xiaomi, for monitoring the respiration status in real time (Xiaomi, 2020) (a) and Guardian G-Volt mask, manufactured by LIGC Applications, equipped with a self-sterilizing graphene filter (Dezeen, 2019; Stanford et al., 2019) (b)

A University of California research team is developing a wearable sensor that is applied to a mask for detecting the presence of proteases, which are enzymes that speed up the breakdown of proteins that are related to the COVID-19 virus (Yim et al., 2020; Labios, 2021) (Fig. 12a). The sensor includes a small blister and a strip used to collect the proteases present in the exhaled breath. To carry out a test, the user must squeeze the blister, causing the NPs to contact the strip surface, which changes color in the presence of proteases and thus the COVID-19 virus. Harvard and MIT researchers are developing a face mask that generates a fluorescent emission if a person infected

with COVID-19 breathes, coughs, or sneezes. Ribonucleic acid (RNA) or deoxyribonucleic acid (DNA) genetic material is deposited by a lyophilizer on the fabric surface, which collects the aqueous particles that carry the virus without killing them (Fig. 12b). The virus binds with the deposited material producing a radiative emission, not visible to the naked eye but quantifiable with a fluorimeter. The proposed solution requires two conditions for activation: the sample's moisture (saliva, mucus, etc.) and the virus's genetic sequence. Rabiee et al. (2020) developed point-of-use rapid detection of the COVID-19 virus in the form of a mask coated by metallic NPs doped with an organo-metallic framework; interaction with the virus changes the optical properties of NPs, resulting in color variation of the mask's surface. The authors also provided an overview of the different diagnostic methods and techniques for rapid detection of COVID-19 using optical techniques that exploit the easy absorption/desorption of the nanostructured materials (i.e., gold, silver, magnetic, and metal-organic NPs) (Ghasemi et al., 2015; Nejad et al., 2020; Rabiee et al., 2020). The aim is to develop point-of-care solutions that identify the presence of a virus or even its concentration in the air in a rapid and non-invasive way (de Fazio et al., 2021). Giovannini et al. (2021) investigated different techniques and critical technical aspects of detecting virus by analyzing exhaled breath, including electrochemical, chemoresistive, biological gas sensors, or the breath's liquid phase (i.e., exhaled breath aerosol (EBA) or exhaled breath condensate (EBC)) using polymerase chain reaction (PCR) based detection methods.

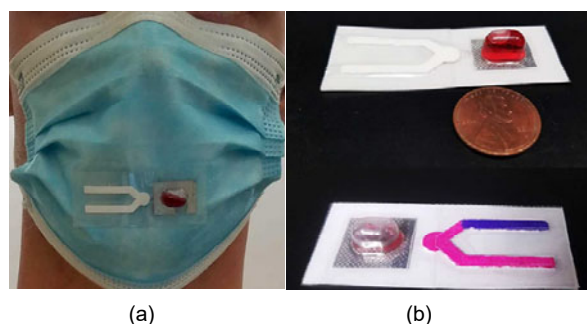

Fig. 12 A sensor developed by the University of California which can detect the presence of the proteases related to the COVID-19 virus in exhaled breath (a) and details of the sensor before application on the mask (b) (Yim et al., 2020; Labios, 2021)

2.3 Study of implantable devices for detecting the effects of COVID-19 on the human body

Recent studies have been aimed at determining the effects of COVID-19 on the human body; in fact, the data suggest a correlation between cardiovascular diseases and COVID-19, emerging several months after negative virus testing. Particularly, several infected patients show acute cardiovascular events in addition to other complications correlated with COVID-19 (Diller et al., 2020; Paramasivam et al., 2020). Implantable cardiac monitoring devices are a smart solution to remotely check the cardiac muscle's integrity and functionality, avoid long hospital stays, better respect a fixed schedule of exams, and rapidly detect the onset of deteriorations in clinical conditions. The COVID-19 pandemic has significantly changed medical activities inside the hospital; the main objective is to reduce the number of individuals accessing the hospital facility to minimize the contagion risk for patients and caregivers.

The introduction of remote monitoring of the patient's cardiovascular condition was proposed by Mabo et al. (2012), who reported the main results of the COMPASS trial, a randomized trial for long-term remote monitoring of patients implanted with a pacemaker. "Home Monitoring®, produced by Biotronik, has been employed to automatically transmit the data acquired by implantable devices to a secure Internet site, where the medical staff analyzes the data to determine the patient's status" (Biotronik Inc., 2020). The COMPASS trial involved 538 patients, who were randomly selected for remotely monitoring follow-up observation for 18.3 months. The authors demonstrated that there was a change in pacemaker programming or drug therapy in 62% of cases, versus 29% in the control group. Remote monitoring is a safe and efficient solution for long-term follow-up of permanently paced patients, reducing healthcare costs and the risk of hospital overcrowding.

Furthermore, Versteeg et al. (2014) analyzed the influence of remote patient monitoring systems on the outcome of patients' clinical course. The study, called REMOTE-cardiac implanted electronic device (CIED), considered 900 patients affected by cardiac diseases and with an implantable cardioverter-defibrillator, monitored every 3–6 months over a 2-year time period. The results obtained demonstrated

that remote patient monitoring could help implement a centralized care monitoring system. An increase in intracardiac pressure is the main indicator of a worsening heart condition and is crucial for early and rapid intervention, which reduces the probability of complications. “CardioMEMS HF[®], manufactured by Abbott, is a wireless monitoring platform for detecting variations in pulmonary artery pressure, an indicator of heart condition” (Sandhu et al., 2016; Abbott Inc., 2021). The system allows real-time notification of the patient’s conditions, secure data analysis and access, and tailored management of user follow-up. The implantable micro-electro-mechanical-system (MEMS) device is battery-free, but it uses radio frequency (RF) technology to acquire and transmit pulmonary pressure data, exploiting the energy provided by a proprietary electronic monitoring system (Fig. 13a).

The sensor includes a coil and pressure-sensitive capacitor enclosed in a silica cover and two nitinol loops to hook it up to the pulmonary artery branch (Fig. 13b). The capacitance value depends on BP and varies with the resonance frequency accordingly; the frequency shift signal is processed by the electronic section to extract the pressure waveform. The acquired data are then sent to a secure database and are available to the medical staff on the CardioMEMS proprietary website. The clinical test was reported in the CHAMPION trial, which considered 550 heart failure (HF) individuals, demonstrated a great reduction in hospitalization time, and showed the device ability to monitor hemodynamic parameters of the HF patient in real time (Givertz et al., 2017).

Similarly, Endotronix Inc. (Chicago, IL, USA) “has developed the Cordella system, suitably designed for HF patients for continuous monitoring of health conditions and remote treatment definition” (Mullens et al., 2020; Endotronix Inc., 2021). The Cordella system includes an implantable MEMS pressure sensor designed to be placed inside the patients’ pulmonary artery (Fig. 14a) and wirelessly provide real-time data on pulmonary artery pressure to a portable reader (Fig. 14b). The collected data are then wirelessly transmitted to a cloud platform, where the data are stored and analyzed by the company staff.

Furthermore, Walton and Krum (2005) described the “HeartPOD system, manufactured by Abbott Inc., to measure the left atrial pressure (LAP); the system is composed of an implantable sensor

interfaced with a subcutaneous antenna coil, an elaboration module, and a remote clinical software platform. The sensing section does not have a battery, instead is powered by an external telemetry coil and positioned across the inter-atrial septum via trans-septal catheterization. The elaboration module receives and processes the telemetry data and provides patient feedback about the frequency of BP measurements.”

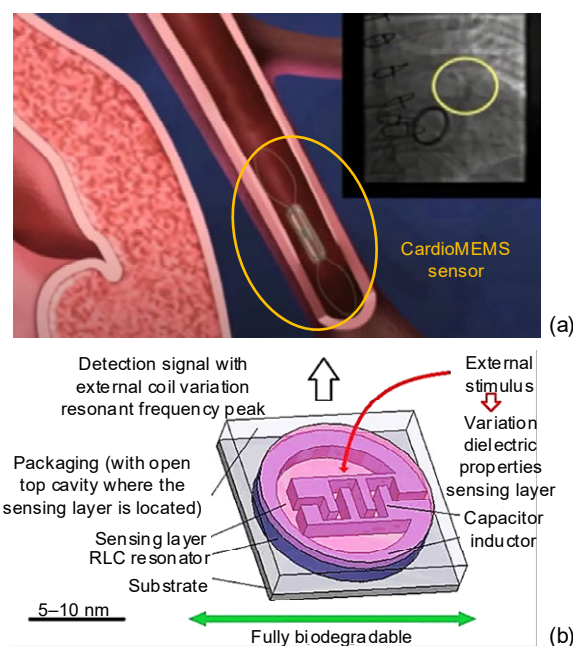

Fig. 13 Positioning of MEMS sensors inside the pulmonary artery branch (a) and resonant detection circuit employed by MEMS sensors to detect pressure variations (b)
Reprinted from Sandhu et al. (2016), Copyright 2016, with permission from Elsevier

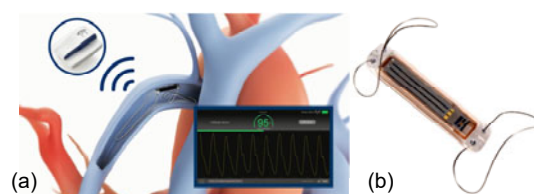

Fig. 14 Positioning of the Cordella sensor, produced by Endotronix Inc., inside the pulmonary artery to monitor blood pressure (a) and details of the Cordella sensor (b)
(Mullens et al., 2020)

V-LAP[™], produced by Vectorious Medical Technologies, is a miniaturized, wireless, battery-free monitoring system for providing detailed information concerning the LAP (Perl et al., 2019; Vectorious Inc., 2021). “The implant must be positioned directly on

the heart's interatrial septum (Fig. 15a) and wirelessly transmits daily hemodynamic data to a cloud platform." The implant includes three components (Fig. 15b): (1) a pressure cup, including the MEMS pressure transducer, positioned on the left atrial side, (2) a sealed tube containing the electronic section and the transmission module, and (3) a braided scaffold, made of nitinol, to anchor the implant to the heart wall.

When opened, the fixation scaffold has an 18-mm diameter on the left atrium and a 16-mm one on the right atrium; the implant features a maximum diameter of 3.8 mm and a length less than 18 mm. The system includes an external unit to supply power to the implant, wirelessly receives the data every day, and shares data with the cloud platform (Fig. 15c).

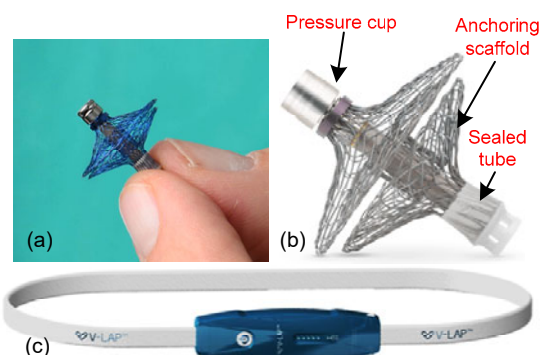

Fig. 15 V-LAP™ implant for remotely monitoring the left atrial pressure (a), its main sections (b), and the V-LAP™ external unit (c) (Vectorious Inc., 2021)

Reprinted from Perl et al. (2019), Copyright 2019, with permission from Springer Nature

3 Overview of commercial wearable solutions for complying with social distancing rules

In this section we investigate innovative wearable applications for complying with the new measures to contain the COVID-19 pandemic, especially in terms of social distancing. In particular, with the global outbreak of the COVID-19 pandemic, several companies have addressed their efforts at developing solutions that can trace the contacts of infected users in previous weeks. Several standard communication technologies (Bluetooth Low Energy (BLE), Wi-Fi, Long-Term Evolution (LTE), etc.) are employed, using properly defined metrics, to determine and track the duration and intensity of the

social contact. Furthermore, several wearable IoT solutions have been proposed to remotely monitor biophysical conditions and detect symptoms commonly associated with COVID-19 early (cough, shortness of breath, low SpO₂ level) (Calabrese et al., 2020; de Fazio et al., 2020b; Grant et al., 2020; Larsen et al., 2020; Seshadri et al., 2020; Visconti et al., 2020).

The Close-to-me device, manufactured by Partitalia Srl, is a device worn by two or more people in the same room, and guarantees one meter of "social distance" (Partitalia, 2020a). The device is based on RF technology and generates a low-frequency radio bubble around the user, which is not invasive (Fig. 16). When the distancing requirement is not satisfied, there will be an acoustic sound and a vibration signal notifying the user that he/she is less than a meter away. Furthermore, through simple implementations, the device can be used for access control, attendance detection, and payment to the company canteen. Close-to-me can be customized and purchased as a bracelet or as a key ring, thus remaining a non-invasive device, lightweight, and almost maintenance-free. It is aimed at simplifying the procedures related to the reopening of companies because it can be easily implemented quickly.



Fig. 16 Graphic representation of the Close-to-me system (a) and front view of the wearer to monitor social distancing (b) (Partitalia, 2020a)

The VITA wearable device, on the other hand, is designed for constant observation of vital parameters in patients who are treatable by telemedicine, in all cases in which it is considered essential to highlight a possible infection (Partitalia, 2020b). The device is equipped with a high-efficiency battery that lasts more than two weeks. It also integrates different sensors for detecting HR, oxygen saturation, and body temperature, and performs an ECG. Thanks to these features, wearables can be used to monitor biophysical conditions of long-term patients, as well as employees in the workplace.

Safe Spacer™ is a patent-pending wearable device that helps users keep social distance within safe limits by accurately detecting when other devices are within a 2-m radius and warning the user with visual, vibrating, or audible alarms (Safe Spacer, 2020) (Fig. 17). Ultra-wideband (UWB) technology delivers 10 times more accuracy than Bluetooth for superior performance, allowing companies to safely reopen the workplace and help stop the spread of COVID-19. In addition, the device emits visual, acoustic, and vibratory warning signals to alert the user of a colleague's presence at a close distance. Safe Spacer can be comfortably worn by users on a bracelet, lanyard, or keychain and features a unique identification (ID) tag and built-in memory that allows contact tracing in the event of coronavirus exposure, keeping organizations safe.

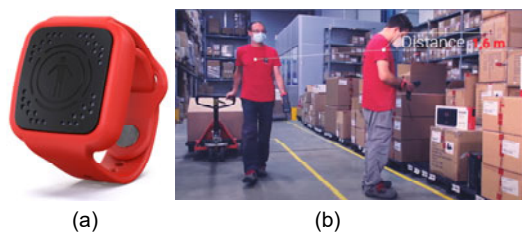

Fig. 17 Safe Spacer™ wearable sensor (a) and an example of an application scenario (b) (Safe Spacer, 2020)

Similarly, Abeeway (2019) developed a Smart Badge™ to aid the user in respecting the social distancing rules in the workplace. It is lightweight and portable, is equipped with sensors that support multiple geolocation technologies, and provides accurate and continuous geolocation data. The device uses a BLE beacon, multi-constellation Global Navigation Satellite System (GNSS)/Global Positioning System (GPS), low-power GPS, and Wi-Fi technologies to detect other workers' proximity, and evaluates the distance between them. Also, an ultra-low-power LoraWAN (wireless area network) communication module is employed and dynamically manages the localization technology as a function of the operating scenario to optimize the device autonomy (de Fazio et al., 2020a). CrowdLED Inc. has launched the CrowdRanger social distancing wearable device, based on RF technology to sense when another device is within a set range (Crowdsaver, 2020). If this condition is verified, the device

generates a visual, acoustic, and vibratory warning signal to maintain social distancing, increasing the audio volume, warning color, and vibration intensity depending on the distance and contact duration. The alarm stops when the two users move beyond the safe distance. The device records the duration and distance of each contact up to 28 d, allowing the administrator to check the data to identify potentially infected people.

Nymi Inc. has developed a workplace wearable wristband based on near-field communication (NFC) and BLE technology for contact tracing and social-distancing applications (Nymi Inc., 2021). Specifically, the device uses these technologies to determine and quantify social contacts, providing suggestions to the administrators concerning workplace safety. At the end of the day, each wristband sends the acquired information to a central unit to determine potential risks and worker behaviors. The device identifies the user via an integrated fingerprint reader and biometric parameters to ensure the safety and security of connected workers.

The iFeel-You bracelet is also equipped with sensors to monitor human parameters and warn the user if his/her body temperature is higher than 37.5 °C (Italian Institute of Technology, 2020) (Fig. 18a). Furthermore, using Bluetooth frequencies, the device monitors the distance between people and detects movements and the distance between bracelets. Once two bracelets are too close, they vibrate and sound, making the wearer aware and ready to keep a safe distance. Similarly, Estimote, which specializes in beacon location devices, used its skills to develop a device to contain the COVID-19 pandemic (Estimote, 2020) (Fig. 18b). A new line of wearable products was proposed to monitor the coronavirus diffusion potential between users in the workplace. These devices represent a powerful solution to keep track of any potential contagion between workers and limit the local spreading of the disease before it becomes uncontrollable. The hardware section consists of a passive GPS receiver and proximity sensors based on Bluetooth and ultra-wideband radio signal analysis, a rechargeable battery, and a built-in LTE transceiver. It also includes a manual control to modify the user's health condition, and assigns to the user the certified state of healthy, symptomatic, or COVID-19 infected. If the wearer's status changes, indicating possible or

verified infection, the system also updates others with whom the wearer has been in contact depending on proximity and location-data history. The status is also updated in a health dashboard that provides detailed logs of possible contacts for centralized management.



Fig. 18 iFeel-You bracelet developed by the Italian Institute of Technology (Italian Institute of Technology, 2020) (a) and line of wearable products manufactured by Estimote Co. for containing the COVID-19 pandemic (Estimote, 2020) (b)

4 Tracing systems for containing the COVID-19 pandemic

In this section we analyze current technologies (including Apps, integrated sensors, and ad hoc devices) to overcome the problems arising from this pandemic. The focus is on the various technological approaches that could be applied to break down infection and return to everyday life.

Immuni (2020) focused on the Immuni App. It introduces a new approach for containing epidemics, starting with COVID-19. The App has a contact tracing feature based on Bluetooth technology. When users discover that they have tested positive for the COVID-19 virus, the Immuni notification system allows them to anonymously alert people with whom they have been in close contact and who may also have been infected. By being promptly informed (potentially even before developing symptoms), users can contact their general practitioner (GP) to discuss their situation. It is available for iOS and Android operating systems. The source code was developed by Bending Spoons S.p.A., and released under the GNU Affero General Public License version 3. Immuni can determine that a risky exposure has occurred between two users without knowing who those users are or where they met. The App does not collect any data that would identify the user, such as name, date of birth, address, telephone number, or email address. To determine the contact, Immuni uses BLE technology

(a variant of the standard Bluetooth that uses much less power for communication) and does not use geolocation data of any kind, including GPS data. Immuni has paid great attention to safeguarding user privacy during its design and development. The data are collected and managed by the Ministry of Health and stored on servers located in Italy. All App data and connections with the server are protected. Also, to ensure that only users who test positive for the SARS-CoV-2 virus can upload their keys to the server, the upload procedure can be performed only in cooperation with an authenticated healthcare provider. The provider asks the user to provide a code generated by the App and inserts it into a back-office tool.

A high-level description of the system is as follows. Once installed and configured on a device (device_A), the App generates a temporary exposure key (randomly generated and changed daily). The App also starts transmitting a BLE signal that contains a proximity identifier (ID_A1, which is assumed fixed for simplicity). When another device (device_B) using the App receives this signal, it registers ID_A1 locally in his/her memory. At the same time, device_A records the identifier of device_B (ID_B1, which is also considered fixed). Suppose that the user of device_A subsequently tests positive for SARS-CoV-2. In this case, he/she can upload the temporary exposure keys to the Immuni server. The Immuni App can obtain the recently transmitted proximity identifiers from the server (including ID_A1 of device_A). Device_B checks its local list of identifiers for new keys uploaded to the server, and if ID_A1 matches, the App warns the user of device_B that he/she may be at risk and provides advice on what to do next (e.g., isolate and call the doctor) (Fig. 19).

If the owner of device_B is in proximity to the user of device_A, there is no certainty that he/she is at risk. Immuni evaluates this risk based on the distance between the two devices and the duration of exposure, which is estimated from the attenuation of the BLE signal received by device_B. The longer the exposure and the closer the contact, the greater the transmission risk. Generally, an interaction lasting only a couple of minutes and occurring several meters away is considered low risk. However, the risk model may evolve as more information on the transmission

properties of SARS-CoV-2 becomes available. Note that the distance estimation is affected by different errors. The BLE signal attenuation depends on factors such as the relative orientation of the two devices and the presence of obstacles (including human bodies). Also, note that the App has been heavily downloaded and used since it was released (Fig. 20).

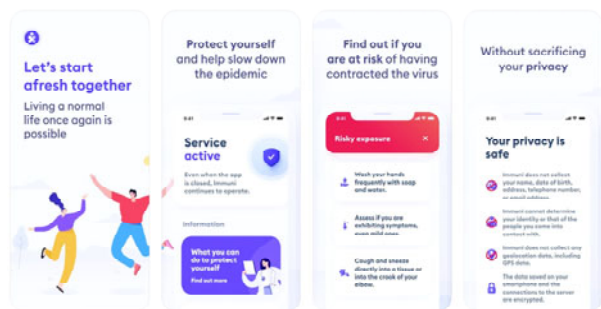

Fig. 19 Graphical representation of how the Immuni App works (Immuni, 2020)



Fig. 20 Graphs and histograms reporting some Immuni App statistics (Immuni, 2020)

Wearable and tracking solutions can be used to prevent cross-infection among individuals, and provide measures of temperature, HR, blood oxygen saturation, and real-time positioning information. Singapore was the first country to try to contain the COVID-19 pandemic using a tracing App. TraceTogether Tokens represents an intelligent solution to address COVID-19 using technology (TraceTogether Tokens, 2020). The local authorities declare that the application has quickly received wide popularity and covers 2.1 million people, representing 35% of the population. The system includes wearable devices that support the contact tracing App in identifying individuals potentially infected by users

who tested positive for COVID-19 (Fig. 21a). The wearable devices allow thousands of vulnerable elderly people who do not have a smartphone to be covered by the tracking system. Each user is assigned a national ID that is used by the TraceTogether App for the tracking process; if a user tests positive for COVID-19, he/she must report his/her token to local health authorities because he/she is not able to transmit data over the Internet. The tracking system uses the log data to identify and warn others who might have been infected. The mobile App correlates the verified infected user with those who have been in contact with him/her. The App uses a time-sensitive ID to determine the user, and the relative signal strength indicator (RSSI) readings between two smartphones to identify the proximity and duration of the contact between two users (Fig. 21b).

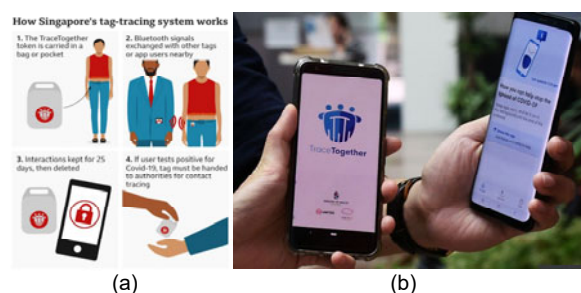

Fig. 21 Schematic representation of the TraceTogether tracking system (a) and mobile application used to support the tracking system (b) (TraceTogether Tokens, 2020)

Simmhan et al. (2020) presented another contact tracing App, called GoCoronaGo (GCG), which exploits the potential of BLE technology. The authors developed and analyzed the first experiments after distributing the App to more than 1000 users at the Indian Institute of Science campus in Bangalore. This App uses BLE technology and includes a unique device ID, called a contact, which is recognized by the other nearby devices with App scanning. The App stores information on the local device. If a user verifies his/her COVID-19 positivity, the Bluetooth contacts are uploaded to a central database and contacts are notified. This mechanism can drastically reduce the time needed to track contacts and slow the spread of the virus.

The main limitation of the Bluetooth technology is the low reliability and asymmetry in detecting nearby users and the low accuracy in distance

measurement. The high number of adoptions necessary for contact tracing to be effective leads us to believe that it is still important to use complementary digital contact tracing with manual methods. The proposed App (GCG) for digital tracking aims to solve these limitations. The key feature of the proposed approach is the collection of the device contact trace data in a centralized database, regardless of whether the person is diagnosed as positive or negative for COVID-19. The proximity data collected from all App users are used to create a time contact chart. The vertices are devices, and the edges indicate the proximity between devices for a certain period and with the given Bluetooth signal strength. According to the WHO guidelines, when a user of the GCG App becomes positive for COVID-19, graphical algorithms quickly identify the primary, secondary, and other contacts. Also, even if the infected user has lost the Bluetooth connection, successful scans from other nearby devices can alert the relevant contacts, increasing detection reliability. Of course, centralized contact data collection has some drawbacks, specifically, the privacy implications of tracking interactions. However, the system implements some precautions to try to remedy this inconvenience:

1. The App is designed not on a municipal, regional, or national scale, but only for distribution within institutions and closed campuses; therefore, the data collected are owned by the host institution and not by a central authority.

2. Users are not required to share any personal information, and the devices are identified using a randomly generated ID.

From an architectural perspective, Fig. 22 shows a high-level diagram of the developed traceability system. Authorized institution users are provided with individual invitation codes by a separate entity within the institution, typically the information technology (IT) department. The office maintains a mapping from the user's unique invitation code to the actual individual along with their contact details (Fig. 23).

The user can download the GCG App from an institutional link or the Google Play Store. During installation, users enter the invitation code in the App, which validates it with the GCG backend servers and returns a unique user ID, a personal identification

number (PIN), and the device ID. Other required information collected by the App during installation is the operative system version and phone model. This information identifies the strength of the Bluetooth signal and translates it into a distance estimate. Thus, the GCG App acts as both a client and a server when using BLE scanning and advertising modalities.

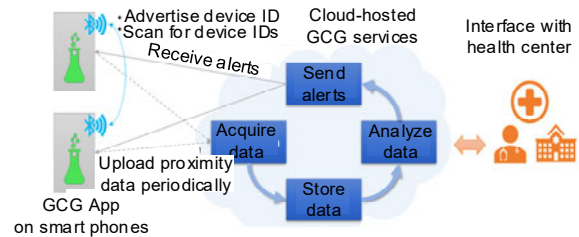

Fig. 22 Graphical representation of the architecture of the GCG traceability system

Reprinted from Simmhan et al. (2020), Copyright 2020, with permission from Indian Institute of Science

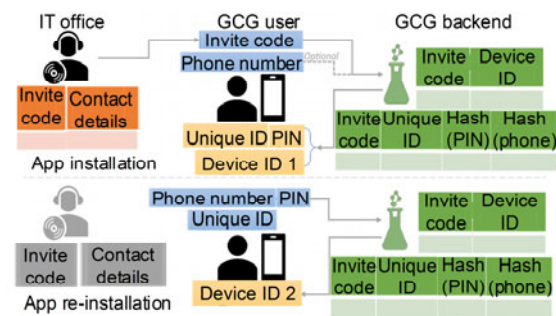

Fig. 23 Identifier mapping during GCG App installation

Reprinted from Simmhan et al. (2020), Copyright 2020, with permission from Indian Institute of Science

In addition to tracking Bluetooth contact data, the GCG App offers several functionalities to inform users about COVID-19 and engage them in preventing its spread. Screenshots of these user interface elements are shown in Fig. 24.

Unfortunately, COVID-19 has many strange long-term symptoms; for example, many symptoms disappear entirely before they suddenly start to worsen, and other patients who are declared negative are later positive again. The high number of strange cases highlights the need for continuous monitoring of patient health. For these reasons, the device proposed by Jeong H et al. (2020) provides round-the-clock monitoring of COVID-19 patients and those exposed to them. The device can monitor hospitalized patients and continue supervision at home. The device

can monitor the progress of COVID-19 patients, and provide early warning signals to frontline workers who are more at risk of contracting this disease.

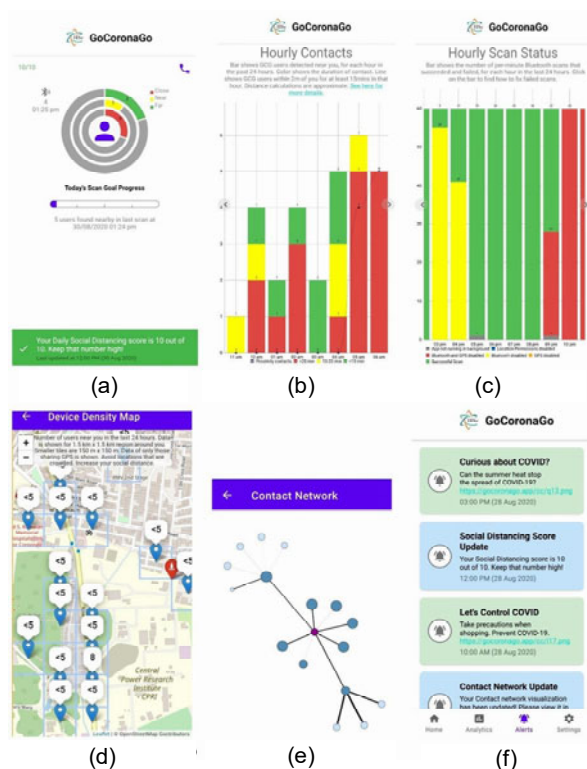

Fig. 24 User interface and analytics in the GCG v0.7 Android App: (a) main screen; (b) hourly contacts; (c) hourly scans; (d) device density heatmap; (e) contact network; (f) alerts panel

Reprinted from Simmhan et al. (2020), Copyright 2020, with permission from Indian Institute of Science

Girolami et al. (2020) analyzed the wireless BLE signals commonly used by commercial mobile devices. Their work is based on the SocializeME framework, which is designed to collect proximity information and detect social interactions across personal and heterogeneous mobile devices. The experimental results, obtained by several measurement tests on real users, highlighted the technical limitations and qualitative performance of the proposed technique in terms of the received signal strength (RSS), packet loss, and channel symmetry for different body positions. Specifically, they obtained a dataset with thousands of Bluetooth signals (BLE beacons) collected over 11 h. They analyzed the results obtained by the SocializeME Detector (SME-D) algorithm, which is designed to automatically detect social interactions based on

collected wireless signals; an overall accuracy of 81.56% and an F-score of 84.7% were achieved. The proposed work aims to design software and analytical tools that can detect face-to-face interactions without adopting customized hardware and provide users with a non-invasive technological solution (hardware/software). An essential aspect of this work concerns the SocializeME solution that uses BLE technology, allowing mobile devices to transmit advertising information and capture their intentions.

The first version of the SocializeME App was developed and finalized to advertise the presence of a local device, and thus its owner, to other devices within a circle with a radius of a few meters and store the information of the received third-party advertising packages. The App presents some drawbacks. For example, only Android devices support background scanning and advertising modes; in contrast, iOS automatically stops advertising and scanning operations while the App switches to the background. Various experimental sessions were conducted to analyze the impact of user position on signal quality and, consequently, on the correct detection of face-to-face interactions in a completely realistic context. The tests were carried out based on a face-to-face interaction characterized by three different physical distances between the participants: (1) non-interaction (3–3.5 m), (2) approach (3–2.5 m), and (3) interaction (2.5–1 m).

Table 1 summarizes the results of their experimental activity. The table shows, for each session, the number of volunteers, the number of different smartphone models, the number of beacons collected, and the overall duration of the session tests. Then, the duration column provides the average time it took for volunteers to complete a specific session.

Table 1 Experimental results reported in Girolami et al. (2020)

Session	Number of volunteers	Number of smartphone models	Number of beacons	Duration (min)
1	8	4	53 375	111
2	9	6	87 467	114
3	10	4	205 152	111
4	8	5	193 603	130
5	8	3	247 776	130
6	6	4	27 886	73
Total	49	26	815 259	669

The SocializeME framework relies on the analysis of beacon messages collected in their experimental campaign (Girolami et al., 2020). In detail, the authors used the RSS value experienced by each pair of users involved in an interaction and the beacon loss rate as the main parameters of their algorithm called SME-D. This framework analyzes the time series of beacon messages received by each dyad using a sliding time window of predefined duration (Δ_{up}) and evaluates the following conditions to identify the start time of the social interaction: (1) at least a given percentage ($p\%$) of the expected beacons are received; (2) the RSS of received beacons is greater than or equal to a threshold value T_{RSS} .

If the two conditions are met in at least one of the dyad's two directions, social interaction is determined to have started in that time window. Therefore, the interaction is considered active until the closing condition is detected. Namely, the time interval between the last beacon received (with $RSS \geq T_{RSS}$) is greater than or equal to Δ_{down} .

In Ashraf et al. (2020), a smart edge surveillance system was proposed to monitor, alert, and detect the user's heartbeat, body temperature, heart conditions, heart frequency, and some of the radiological characteristics, to detect infected (suspected) persons who use the wearable smart gadgets. Thanks to the proposed framework, a continuously updated map/diagram of the contact chain of people infected with COVID-19 was also created. Thus, the proposed model helps detect and trace the contagious person and retain the patient data record for analysis.

To collect data, they used two main modules (wearable and non-wearable); the wearable one includes an HR sensor and an infrared temperature sensor (Fig. 25a). The non-wearable module is connected to the file entrance of the airport passage gates or even in shopping malls where large human crowds are expected. According to WHO guidelines, the wearable module provides BP and respiratory data of a person suspected of having COVID-19, to control infected users (Fig. 25b). This mechanism acquires real-time values (from sensors in wearable and non-wearable gadgets) and transmits them to the file multi-edge layer nodes, where the possible COVID-19 users' data are analyzed. The proposed framework consists of five stages (Fig. 26):

1. Preliminary phase: the data related to possible COVID-19 cases are transmitted to the edge and cloud layers.

2. Central HUB (data processing and analysis): the data are processed and passed on to the action trigger and graphical mapping unit for nearby alarms and affected authorities.

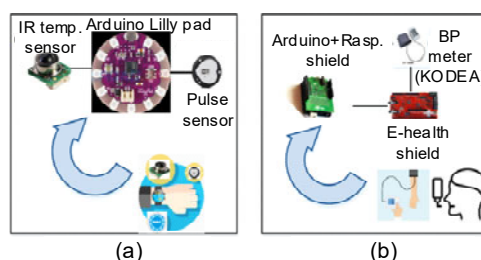

Fig. 25 Setup of wearable (a) and non-wearable (b) devices
 Reprinted from Ashraf et al. (2020), Copyright 2020, with permission from IEEE

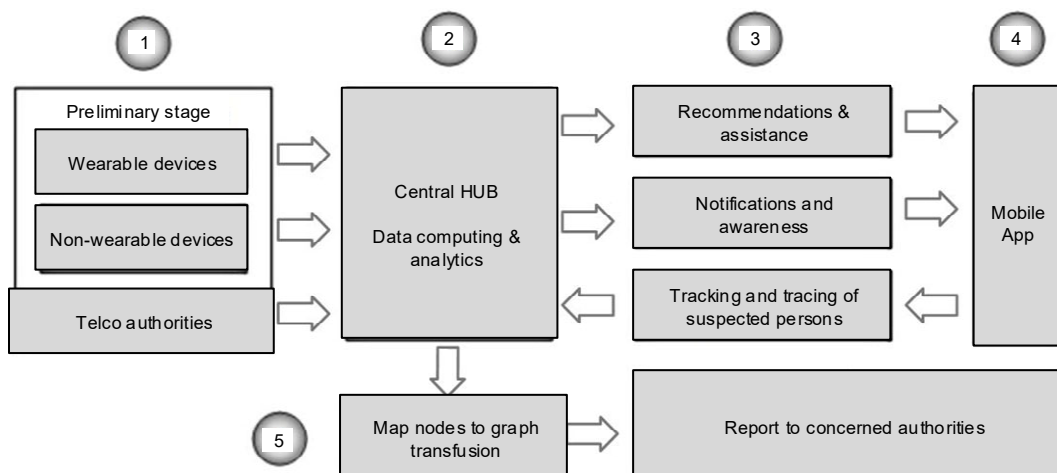

Fig. 26 Block diagram of the proposed system framework
 Reprinted from Ashraf et al. (2020), Copyright 2020, with permission from IEEE

3. Action activation: this stage deals with the transmission of notifications of possible COVID-19 cases.

4. User interface: this stage interacts with the end user through an Android application.

5. Graphic display: this component summarizes the framework’s results in a suitable graphical interface, allowing the suspected COVID-19 nodes (users) to be tracked down.

In Tripathy et al. (2020), an electronic solution, called EasyBand, was presented to manage a safe and gradual opening after removal of restrictions imposed to contain the spread of COVID-19. In particular, it was intended to limit new positive cases through automatic contact detection and encourage social distancing. The device includes sensors for detecting similar nearby devices (from 1 to 4 m), helping citizens stay safe by automatically detecting possible COVID-19 cases. The EasyBand electronics consists of specific building blocks such as a power management unit (PMU) to provide adequate direct current (DC) voltage to all the internal blocks and liquid crystal display (LCD) display, a programmable system chip (PSoC), wireless stack, sensors, vibration motors, and I/O units (Fig. 27).

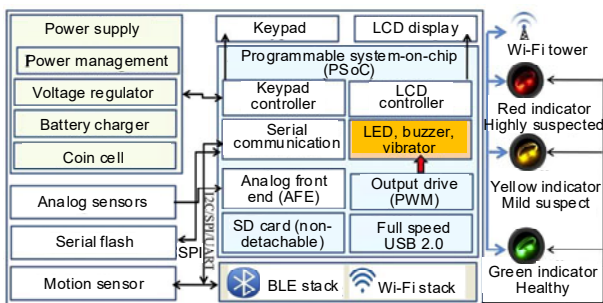

Fig. 27 Block diagram of the EasyBand system

Reprinted from Tripathy et al. (2020), Copyright 2020, with permission from IEEE

The system uses BLE devices to detect the distance between them, and the Wi-Fi unit creates the data connection with a city server via a Transmission Control Protocol/Internet Protocol (TCP/IP) connection. EasyBand also has LEDs with three colors, yellow, green, and red. The green LED indicates a safe condition, yellow a slightly suspicious condition, and red a very doubtful one. These devices can record information (such as device ID, timestamp, and period) over 15 d for other devices in close

proximity in the same area. Before removing the lock file from a zone, all people have to be released with an EasyBand with an active green light as the mobility pass. The device also provides a vibrating alert if a red or yellow device is present within 4 m. It will beep to provide an even more critical warning if it comes into closer proximity with a yellow or red device. If a green device spends a lot of time in close contact with a yellow or red device, its status is changed to yellow (Fig. 28).

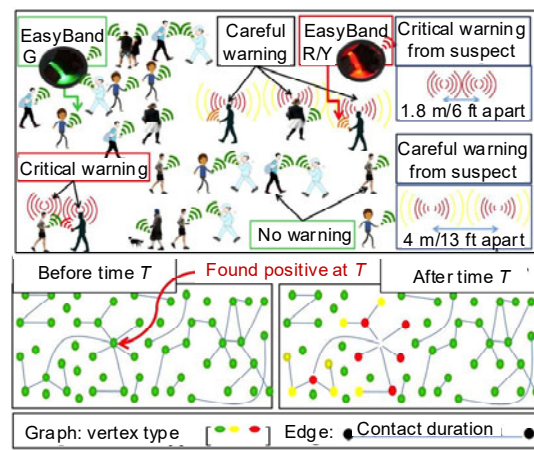

Fig. 28 Contact graph obtained by the EasyBand system before and after time T from a positive detection

Reprinted from Tripathy et al. (2020), Copyright 2020, with permission from IEEE

Dong and Yao (2020) discussed some IoT systems for user tracing using GPS receivers (Paek et al., 2010), microphones (Satoh et al., 2013; Burns et al., 2016), and magnetometers (Jeong S et al., 2019). The simplest method uses GPS technology (based on coordinates) to track users’ trajectories and determine the contact distance (Paek et al., 2010). Although it is feasible, it is also not optimal due to high power consumption and low distance resolution.

One of these tracking systems was shown in Jeong S et al. (2019), whose operative principle is depicted in Fig. 29. Specifically, a magnetometer-based method for contact tracing was proposed which exploits linear correlations of smartphones and magnetometer readings to estimate the distance between phones and detect close contact events between individuals.

RF-based signals, such as Bluetooth (Liu S et al., 2014), Wi-Fi (Sapiezynski et al., 2016), and radio frequency identification (RFID) (Bolic et al., 2015),

are also widely used to detect proximity. Liu S et al. (2014) built a model based on Bluetooth signal propagation to calculate distance values starting from Bluetooth RSS values. This model enables a precise distance resolution of 1 m. Using BLE and Wi-Fi, Liu S et al. (2014) and Sapiezynski et al. (2016) proposed robust and accurate systems to estimate the distance between individuals with high resolution (<0.5 m). Bolic et al. (2015) used the backscatter signals from RFID tags to derive proximity with a small error of 0.3 m.

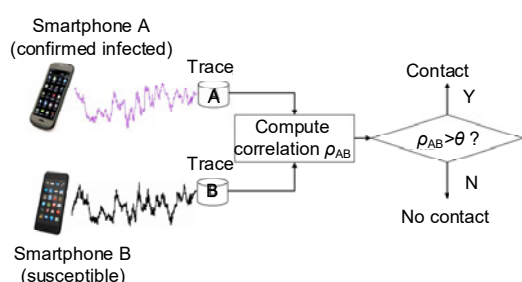

Fig. 29 Smartphone magnetometer based method for contact tracing and social distancing

Reprinted from Jeong S et al. (2019), Copyright 2019, with permission from the authors, licensed under CC BY

Farrahi et al. (2014) derived cellular communication traces from information provided by online social networks, which are excellent indicators for contact tracing. Gupta et al. (2020) imagined a smart city and smart transportation system to ensure social distance. Polenta et al. (2020) employed the Wi-Fi and Bluetooth signals from IoT devices to determine if two individuals respect social distances and developed a web App for users to manage the collected data. Other interesting research can be found in Tedeschi et al. (2020), who proposed an IoT-based distance estimation scheme (using BLE) for tracing COVID-19 contacts, called IoTrace. IoTrace adopts a decentralized model that addresses the privacy disclosure issues of the user device's location and overload.

RFID technology can also represent a good solution for implementing tracing and tracking systems to contain the spread of COVID-19. Rajasekar (2021) introduced a tracking and tracing solution based on an IoT framework for detecting and identifying social contacts using RFID technology and a portable wearable reader. The author considered

the NFC protocol that allows a mobile phone to act as a reader. The mobile App detects if and when another tagged user is close, records and collects information, and passes it to an edge device for processing. Once a suspected case is identified, the people who have been intercepted by the reader are alerted, through the mobile App, of possible contagion, indicating that user quarantine is in order. Garg et al. (2020) developed a new IoT model, based on RFID technology, for infection control and tracing of COVID-19, preserving user anonymity (Fig. 30). The model relies on decentralization of the blockchain to detect and retrieve the chain data. It uses the blockchain to store the data, which ensures anonymity by using distributed ownership and control of the stored data; the data are then processed to alert users who have been in contact with confirmed infected cases. A mobile application supports the proposed model, and generates and stores the encryption key.

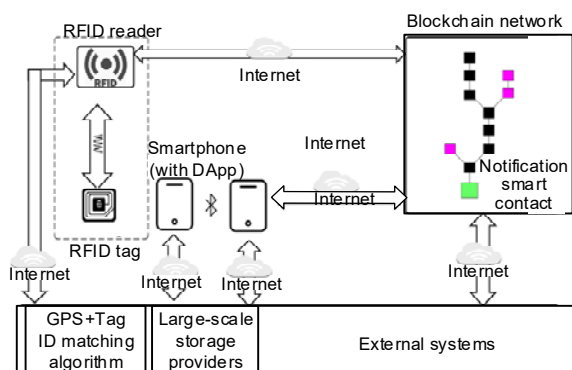

Fig. 30 Blockchain diagram for an anonymity-preserving IoT-based contact tracing system based on RFID technology
Reprinted from Garg et al. (2020), Copyright 2020, with permission from the authors, licensed under CC BY

5 Performance comparison and critical analysis between discussed technologies, devices, and architectures

In this section, we report comparative analyses of the different technologies, sensing devices, and IoT frameworks discussed in the previous sections for early detection of patients affected by COVID-19. These devices are designed to avoid the spread of the virus, help people comply with social distancing, and trace contacts of infected tested users; this section highlights the advantages, limitations, and potential

for each category.

In Section 2, we analyzed several wearable devices that track patient health conditions and identify the first symptoms of COVID-19 infections, and thus suggested further user control to check the actual contagion. Table 2 reports a comparison of the multi-parametric sensing devices discussed in Section 2, from the viewpoints of detected parameters, application position, support of a cloud platform, detection technologies, and invasiveness, to infer the most promising tools for facing future pandemics.

As can be noted, the smart plaster reported in Jeong H et al. (2020), developed by researchers at Northwestern University and Chicago's Shirley Ryan AbilityLab, is lightweight, small, and minimally invasive, and allows continuous monitoring of patient parameters and remote therapy determination, thus avoiding increased pressure on health systems. The Oura ring is a practical and ergonomic solution for detecting the user's principal vital signs, which is significant in diagnosing diseases with a heavy impact on the cardio-respiratory apparatus, like pneumonia induced by COVID-19, while maintaining very low invasiveness and high autonomy (Oura, 2020). The VitalConnect patch is the most complete device in terms of the number of detected parameters,

and collects data related to conditions of the cardiovascular apparatus, posture, and activity level. The device has been extensively used to remotely monitor patient conditions inside a hospital as well as in everyday life, given its dimensions (i.e., 10 cm × 3 cm) and reduced flexibility. We believe that these patch-type devices require more effort to reduce the size and increase the use of flexible and bio-compatible support materials.

In Section 2.2, we provided an overview of the various models of innovative masks, which are useful in limiting the spread of COVID-19, detecting biophysical parameters (e.g., RR), and can be adapted as a function of these parameters. The considered devices are fully reusable and employ a sterilizing mechanism (e.g., UV radiation and Joule effect), thus reducing the environmental impact related to their disposal, a critical issue that is emerging these days (Fadare and Okoffo, 2020). Table 3 reports a comparison of the different smart masks discussed in Section 2.2 regarding filtration efficiency, detected parameters, availability of self-sterilization and forced ventilation systems, and wearability.

In our opinion, the G-Volt mask is the best solution for fighting future pandemics given its high filtration efficiency (i.e., 99%), good wearability, and mainly the self-sterilization capability implemented

Table 2 Comparison of the multi-parameter sensing devices reported in Section 2, in terms of detected parameters, application position, support for a cloud platform, detection technologies, and invasiveness

Device	Detected parameters	Application position	Cloud platform	Detection technologies	Invasiveness
RespiraSense patch (PMD Solutions, 2021)	RR	Chest	Yes	Piezoelectric	Medium
Jeong H et al. (2020)'s LifeSignals patch (LifeSignals, 2020)	RR, HR, Body temp., ECG, SpO ₂ , BP, RR, skin cond.	Suprasternal notch Chest	Yes Yes	ECG, accelerometry ECG, PPG, GSR, accelerometry, microphone	Low Low
Celsius thermometer (Celsius, 2020)	Body temp.	Armpit	No	NTC thermistor	Medium
ECG Alert patch (ECG Alert, 2020)	ECG, HR	Chest	Yes	ECG	Medium
Oura ring (Oura, 2020)	HR, SpO ₂ , HRV	Finger	Oura cloud	PPG	Low
VitalConnect patch (MediBioSense, 2020)	Posture, HR, RR, body temp., ECG, fall detection, activity level	Chest	Vista™ (USA), HealthStream (outside USA)	ECG, PPG, GSR, accelerometry	Low
Lief Rx patch (Lief Therapeutics, 2019)	HRV	Chest	No	ECG	Medium

BP, blood pressure; ECG, electrocardiogram; HR, heart rate; HRV, heart-rate variability; PPG, photoplethysmography; RR, respiration rate; GSR, galvanic skin response; NTC, negative temperature coefficient

Table 3 Comparison between the innovative masks discussed in Section 2.2 regarding filtration efficiency, detected parameters, self-sterilization mechanism, presence of a ventilation system, and wearability

Device	Filtration efficiency	Detected parameters	Self-sterilization mechanism	Forced ventilation	Wearability
Active+ Halo (AirPoP Co., 2020)	99.3% (PFE) 99.9% (BFE)	RR, AQI	Washable	No	High
PuriCare Wearable Air (LG Group, 2020)	93.5% (BFE), 97.3% (virus), 99.1% (pollen)	RR	UV radiation	Yes	Low
Project Hazel (Razer, 2020)	95% (BFE)	–	UV radiation	Yes	Medium
Xiaomi Purely Mask (Xiaomi, 2020)	95% (BFE)	RR, AQI, acceleration	Disposable filter	Yes	High
G-Volt mask (Dezeen, 2019)	99% (BFE)	–	Joule-heating	No	High

AQI, air quality index; BFE, bacterial filtration efficiency; PFE, particle filtration efficiency; RR, respiration rate; UV, ultraviolet

using a graphene-based filter that exploits local Joule-heating due to a small current flowing inside it (Dezeen, 2019). Despite its advanced functionalities (i.e., sensing capability and availability of the forced ventilation system), the wearability of the PuriCare Wearable Air mask (LG Group, 2020) is reduced due to its non-negligible weight (i.e., 126 g).

In Section 3, we highlighted the importance of complying with social distancing rules as a tool to break the chain of contagion, thus containing the spread of the pandemic; we explored several commercial solutions to warn the user of the spread of the pandemic and the proximity of another user. Different technologies have been used to implement such devices (like Bluetooth, BLE, LoraWAN, and RFID) and affect their detection and reliability performance. Table 4 summarizes the devices discussed in Section 3, and compares them based on detection technology, detected parameters, biofeedback typologies, wearability, and cost.

As can be noticed, the considered solutions are very inexpensive, allowing companies to easily implement a monitoring system to maintain social distancing in the workplace, and thus enable safe reopening of economic activities.

From a practical point of view, badge-type devices, like Smart BadgeTM (Abeeway, 2019), feature lower wearability compared to wristband devices, such as Close-to-me (Partitalia, 2020a), which is particularly important in the workplace, where hand-free solutions are the main objective. In addition, sensor integration can provide a dual function, compliance with distancing rules and

worker condition monitoring, thus enabling a detailed and accurate check of pandemic spread.

We have discussed IoT-based frameworks for contact tracking and tracing that combine wearable technologies, mobile applications, and cloud computing. These systems were developed to mitigate the impact of the COVID-19 pandemic and act quickly on local outbreaks. Various technologies have been adopted, such as BLE, Wi-Fi, and RFID, for implementing these systems, and are often jointly employed to improve reliability and accuracy depending on the application scenario. Table 5 reports a comparison of the IoT-based tracking systems discussed in Section 4 in terms of detection technology, detected parameters, scalability, and availability of supporting wearable devices, highlighting the advantages, limitations, and potential to fight future pandemics. Scalability must be intended as a system capability to be applied to a broad audience of people, limiting the invasiveness on users' lives and ensuring their data security.

Bluetooth beacons, Wi-Fi networks, and cellular signals have been widely analyzed to extract information on several human behaviors, including the social interactions. In addition, Bluetooth offers several advantages, such as small device dimensions, low cost and power consumption, and broad compatibility with smart devices.

However, Bluetooth solutions have limited scalability due to their limited interoperability with manual tracking systems, because of the collaboration with the health system, low download rates, and security and privacy concerns. As an alternative to

Table 4 Comparison between different wearable devices for maintaining social distancing, discussed in Section 3, in terms of detection technology, detected parameters, biofeedback typologies, wearability, and cost

Device	Detection technology	Detected parameters	Biofeedback	Wearability	Cost
Close-to-me (Partitalla, 2020a)	BLE	–	Visual vibration	High	Low (€64)
Safe Spacer™ (Safe Spacer, 2020)	UWB	–	Visual acoustic vibration	High	Low (€100)
Smart Badge™ (Abeeway, 2019)	BLE beacon, low GPS, Wi-Fi, LoraWAN	–	Acoustic	Low	Low (€100)
CrowdRanger (Crowdsaver, 2020)	UWB	–	Visual acoustic vibration	Low	Low (€89)
Nymi Workplace Wearables™ (Nymi Inc., 2021)	NFC BLE	HR, ECG, accelerometer, gyroscope, fingerprint	Visual	High	Medium (€200)

BLE, Bluetooth Low Energy; ECG, electrocardiogram; GPS, Global Positioning System; HR, heart rate; NFC, near-field communication; UWB, ultra-wideband

Table 5 Comparison between different IoT-based frameworks for contact tracking and tracing applications reported in the scientific literature, in terms of detection technology, detected parameters, scalability, and availability of supporting wearable devices

Device	Detection technology	Detected parameters	Scalability	Availability
Immuni App (Immuni, 2020)	BLE	Distance time duration	Medium	No
TraceTogether (TraceTogether Tokens, 2020)	BLE	Distance contact time duration	Medium	Yes
GCG (Simmhan et al., 2020)	BLE	Distance contact time duration	Medium	No
Girolami et al. (2020)'s	BLE	Distance contact time duration	Medium	Yes
EasyBand (Tripathy et al., 2020)	BLE	Distance contact time duration	Medium	Yes
Paek et al. (2010)'s	GPS	Distance	Low	No
Jeong S et al. (2019)'s	Magnetometer-based	Magnetic field contact time duration	Low	No
Polenta et al. (2020)'s	BLE	Distance	Medium	Yes
Garg et al. (2020)'s	RFID, NFC	Distance	Low	Yes
Rajasekar (2021)'s	RFID, NFC	Tag detection	Low	Yes
Sapiezynski et al. (2016)'s	Wi-Fi	Distance contact time duration	High	No

BLE, Bluetooth Low Energy; GCG, GoCoronaGo; GPS, Global Positioning System; IoT, Internet of Things; NFC, near-field communication; RFID, radio frequency identification

BLE tracking, frameworks for collecting and analyzing GPS and Wi-Fi localization data are widely investigated by telecommunication companies and government authorities to detect social contacts. Wi-Fi positioning systems can accurately determine the distance between two individuals from a set of monitored access points, and are reliable and scalable, without needing additional hardware components. This approach requires Wi-Fi coverage, which is now widespread in both indoor and outdoor environments. Telecommunication operators can also exploit the cellular signal to determine a mobile phone's position.

Triangulating the information from the home location registers (HLRs) of different mobile stations, the user's location can be established with great precision. We believe that this approach is the best solution for determining information on large-scale population behaviors without any hardware modification, because it processes data that are already available in the communication infrastructure and captures the mobility information of a significant number of people in quasi-real time.

A fundamental aspect related to collection of social interaction data is the privacy issue. Different

strategies are available for managing data collection: centralized, semi-centralized, and decentralized. In the first one, the user periodically sends the Bluetooth device IDs to a backend service; in the semi-centralized approach, the relationship between the App and the device ID is remotely stored, whereas the contact information is collected on the local device (BlueTrace, 2020). In contrast, in a decentralized solution, the Bluetooth device IDs related to social contacts are stored in the local devices, sending them only when the user tests positive. The contact data should be collected in a remote central database in an encrypted manner to protect them from dumping and data breaches. For instance, the GCG system uses a centralized approach based on a unique ID and device ID assigned by the central server during the installation phase to maintain user anonymity (Simmhan et al., 2020). The TraceTogether App employs IDs assigned by the central server or locally generated during the contact tracing activity (TraceTogether Tokens, 2020). Thus, the system does not need any personal user data; the user is recognized only by a random ID that is periodically changed. In contrast, the Immuni App paradigm recently switched from a centralized approach to a decentralized one to enhance privacy protection. Particularly, the user smartphone locally collects the random IDs of persons who are in close proximity, which is produced according to a key stored in the device during the installation process. If the user contracts the virus, an unlock code is provided to transfer the acquired IDs to the central server (Immuni, 2020). The semi-centralized approach is used in the BlueTrace and Aarogya Setu (Aarogya Setu, 2020) applications developed by the Australian and Indian governments to deal with the COVID-19 pandemic.

Usually, the tracing Apps are supported by geolocalization data provided by a GPS receiver and stored in a local SQLite database on the smartphone, making them periodically available to a central server.

Kuhn et al. (2021) explored the numerous protocols proposed by the scientific community for guaranteeing the privacy and anonymity of collected tracking information according to the data protection rules; the analyzed protocols involve both centralized and decentralized approaches, such as decentralized privacy-preserving proximity tracing (DP-3T) (DP-3T, 2021), the Google-Apple exposure notification

(GAEN) framework (Apple Inc., 2021), pan-European privacy-preserving proximity tracing (PEPP-PT, 2020), and the robust and privacy-preserving proximity tracing protocols (ROBERT) (PRIVATICS Team Inria and Fraunhofer AISEC, 2021). Furthermore, the authors proposed a critical analysis of the considered approaches to highlight their strengths and weaknesses. Finally, the discussion indicated that none of the discussed protocols could ensure localization and identity protection from user and server perspectives. In particular, a centralized approach could expose the localization data of alerted users, as well as the hybrid solutions, such as the DESIRE (Castelluccia et al., 2020) and ConTra-Corona (Beskorovajnov et al., 2020) protocols.

In this context, Sun et al. (2020) developed a security and privacy detection method, called Covid Guardian, which identifies the shortcomings of the protection systems by combining three steps: personal identification information (PII) analysis, dataflow analysis to detect privacy hazards, and malware detection. Using this assessment method, the authors tested 40 Apps, including TraceTogether, COVID-Safe (Australian Government Department of Health, 2020), and Aarogya Setu; the obtained results demonstrated that no application could completely safeguard user security and privacy from all threads.

6 Conclusions

The COVID-19 pandemic, afflicting the world population, is pushing companies and the scientific community to develop solutions to contain the spread of the virus, detect the first symptoms of the infection early, and monitor the health conditions of infected patients during quarantine. This paper provides a careful and in-depth analysis of IoT-based wearable devices for remotely monitoring the biophysical parameters related to COVID-19 to avoid crowding the hospitals. We have also explored several commercial wearable solutions to make users aware of social distancing in workplaces, which is fundamental for reopening economic activities that are heavily affected by long periods of lockdown. We have also provided an overview of innovative architectures based on IoT, wearable devices, and cloud computing that track the contacts of tested

infected individuals, thus breaking the contagion chain. Finally, we have critically analyzed and compared the different discussed solutions, provided ideas for investigation, and highlighted the potential for developing innovative tools for facing future pandemics.

Our scientific work focuses on applications based on wearable devices for fighting the COVID-19 pandemic, including the extremely popular mobile tracing applications, unlike similar review papers that cover other monitoring solutions (drones, robotic applications, etc.) (Nasajpour et al., 2020; Al-Humairi and Kamal, 2021). Furthermore, review papers covering the same topics do not always consider commercial devices, including intelligent masks, which are extensively investigated in this paper (Chamola et al., 2020; Kumar et al., 2021). In addition, in our review paper, we dedicate an entire section to wearable commercial solutions (e.g., smart badges, smartwatches, and smart bracelets) for complying with social distancing rules, mainly in workplaces, which are allowing a rapid and safe resumption of economic activities; similar works rarely consider this topic (Yousif et al., 2021). Finally, we have also explored several wearable and implantable applications for monitoring the effects of COVID-19 on the cardiovascular system, usually not covered by similar works (Behar et al., 2020; Hedayatipour and Mcfarlane, 2020). Therefore, we believe that the accuracy and completeness of this paper represent its actual added value and provide the reader with a comprehensive overview of IoT-based solutions for tackling the COVID-19 pandemic.

Contributors

Roberto DE FAZIO and Paolo VISCONTI designed the research and drafted the paper. Nicola Ivan GIANNOCARO and Miguel CARRASCO processed the data and helped organize the paper. Roberto DE FAZIO, Paolo VISCONTI, and Ramiro VELAZQUEZ revised and finalized the paper.

Compliance with ethics guidelines

Roberto DE FAZIO, Nicola Ivan GIANNOCARO, Miguel CARRASCO, Ramiro VELAZQUEZ, and Paolo VISCONTI declare that they have no conflict of interest.

References

8 West, 2020. Covid-19 Early Warning System for Front Line Medical Staff Shows Encouraging Results. <https://www.8west.ie/crew.pdf> [Accessed on Jan. 26, 2021].

- Aarogya Setu, 2020. Aarogya Setu Mobile App. <https://mygov.in/aarogya-setu-app/> [Accessed on May 31, 2021].
- Abbott Inc., 2021. About the CardioMEMS HF System. <https://www.cardiovascular.abbott/us/en/hcp/products/he-art-failure/pulmonary-pressure-monitors/cardiomems/about.html> [Accessed on June 21, 2021].
- Abeeway, 2019. Smart Badge. <https://www.abeway.com/smart-badge/> [Accessed on Jan. 25, 2021].
- Adiputra RR, Hadiyoso S, Hariyani YS, 2018. Internet of Things: low cost and wearable SpO₂ device for health monitoring. *Int J Electr Comput Eng*, 8(2):939-945. <https://doi.org/10.11591/ijece.v8i2.pp939-945>
- AirPoP Co., 2020. Active+ Halo Smart Mask. <https://www.airpophealth.com/us/airpop-active-smart-black-yellow> [Accessed on Feb. 11, 2021].
- Al-Humairi SNS, Kamal AAA, 2021. Opportunities and challenges for the building monitoring systems in the age-pandemic of COVID-19: review and prospects. *Innov Infrastr Sol*, 6(2):79. <https://doi.org/10.1007/s41062-020-00454-0>
- Apple Inc., 2021. Privacy-Preserving Contact Tracing - Apple and Google. <https://www.apple.com/covid19/contact-tracing> [Accessed on May 31, 2021].
- Ashraf MU, Hannan A, Cheema SM, et al., 2020. Detection and tracking contagion using IoT-edge technologies: confronting COVID-19 pandemic. *Int Conf on Electrical, Communication, and Computer Engineering*, p.1-6. <https://doi.org/10.1109/ICECCE49384.2020.9179284>
- Australian Government Department of Health, 2020. COVIDSafe App. <https://www.health.gov.au/resources/apps-and-tools/covidsafe-app> [Accessed on May 31, 2021].
- Behar JA, Liu CY, Kotzen K, et al., 2020. Remote health diagnosis and monitoring in the time of COVID-19. *Physiol Meas*, 41(10):10TR01. <https://doi.org/10.1088/1361-6579/abba0a>
- Beskorovajnov W, Dörre F, Hartung G, et al., 2020. ConTra Corona: Contact Tracing Against the Coronavirus by Bridging the Centralized-Decentralized Divide for Stronger Privacy. *IACR Cryptol. ePrint Arch*, p.1-47.
- Biotronik Inc., 2020. Home Monitoring Datasheet. <https://www.biotronik.com/en-us/products/services/home-monitoring> [Accessed on June 21, 2021].
- BlueTrace, 2020. BlueTrace, a Privacy-Preserving Protocol for Community-Driven Contact Tracing across Borders. <https://bluetrace.io> [Accessed on May 31, 2021].
- Bolic M, Rostamian M, Djuric PM, 2015. Proximity detection with RFID: a step toward the Internet of Things. *IEEE Perv Comput*, 14(2):70-76. <https://doi.org/10.1109/MPRV.2015.39>
- Burns G, Liroy M, Rongo E, 2016. Proximity Detection of Internet of Things (IoT) Devices Using Sound Chirps. US Patent 9 438 440.
- Calabrese B, Velázquez R, Del-Valle-Soto C, et al., 2020. Solar-powered deep learning-based recognition system of

- daily used objects and human faces for assistance of the visually impaired. *Energies*, 13(22):6104. <https://doi.org/10.3390/en13226104>
- Castelluccia C, Bielova N, Boutet A, et al., 2020. DESIRE: a third way for a European exposure notification system leveraging the best of centralized and decentralized systems. <https://arxiv.org/abs/2008.01621>
- CDC, 2020. Coronavirus Disease 2019 (COVID-19). Centers for Disease Control and Prevention. <https://www.cdc.gov/coronavirus/2019-ncov/index.html> [Accessed on Dec. 19, 2020].
- Celsius, 2020. For Families, Body Temperature Measurement, Body Temperature Device. <https://www.celsius.com/pages/for-families> [Accessed on Jan. 25, 2021].
- Chamola V, Hassija V, Gupta V, et al., 2020. A comprehensive review of the COVID-19 pandemic and the role of IoT, drones, AI, blockchain, and 5G in managing its impact. *IEEE Access*, 8:90225-90265. <https://doi.org/10.1109/ACCESS.2020.2992341>
- Chen QG, Tang LQ, 2020. A wearable blood oxygen saturation monitoring system based on bluetooth low energy technology. *Comput Commun*, 160:101-110. <https://doi.org/10.1016/j.comcom.2020.05.041>
- Chen XY, Xu CH, Chen BC, et al., 2020. In-ear thermometer: wearable real-time core body temperature monitoring. Poster Abstract. Proc 18th Conf on Embedded Networked Sensor Systems, p.687-688. <https://doi.org/10.1145/3384419.3430442>
- Chu M, Nguyen T, Pandey V, et al., 2019. Respiration rate and volume measurements using wearable strain sensors. *NPJ Dig Med*, 2(1):8. <https://doi.org/10.1038/s41746-019-0083-3>
- Chung HU, Rwei AY, Hourlier-Fargette A, et al., 2020. Skin-interfaced biosensors for advanced wireless physiological monitoring in neonatal and pediatric intensive-care units. *Nat Med*, 26(3):418-429. <https://doi.org/10.1038/s41591-020-0792-9>
- Cognet Things Inc., 2020. Covid-19 Patient Tracker, Smart Wearable for Worker Safety & Insights. <http://www.cognetthings.com/index.html> [Accessed on June 21, 2021].
- Crowdsaver, 2020. CrowdRanger | Social Distancing Wearable. <https://crowdsaver.net/crowdranger/> [Accessed on Feb. 11, 2021].
- de Fazio R, Cafagna D, Marcuccio G, et al., 2020a. Limitations and characterization of energy storage devices for harvesting applications. *Energies*, 13(4):783. <https://doi.org/10.3390/en13040783>
- de Fazio R, Cafagna D, Marcuccio G, et al., 2020b. A multi-source harvesting system applied to sensor-based smart garments for monitoring workers' bio-physical parameters in harsh environments. *Energies*, 13(9):2161. <https://doi.org/10.3390/en13092161>
- de Fazio R, Sponziello A, Cafagna D, et al., 2021. An overview of technologies and devices against COVID-19 pandemic diffusion: virus detection and monitoring solutions. *Int J Smart Sens Intell Syst*, 14(1):1-28. <https://doi.org/10.21307/ijssis-2021-003>
- Dezeen, 2019. Guardian G-Volt Masks Use Graphene and Electrical Charge to Repel Viruses. <https://www.dezeen.com/2020/03/06/guardian-g-volt-face-mask-graphene-coronavirus-bacteria/> [Accessed on Feb. 21, 2021].
- Diller GP, Gatzoulis MA, Broberg CS, et al., 2020. Coronavirus disease 2019 in adults with congenital heart disease: a position paper from the ESC working group of adult congenital heart disease, and the International Society for Adult Congenital Heart Disease. *Eur Heart J*, 42(19):1858-1865. <https://doi.org/10.1093/eurheartj/ehaa960>
- Donaghy E, Atherton H, Hammersley V, et al., 2019. Acceptability, benefits, and challenges of video consulting: a qualitative study in primary care. *Br J Gen Pract*, 69(686):e586-e594.
- Dong YD, Yao YD, 2020. IoT platform for COVID-19 prevention and control: a survey. *IEEE Access*, 9:49929-49941.
- DP-3T, 2021. Decentralized Privacy-Preserving Proximity Tracing. <https://github.com/DP-3T/documents> [Accessed on May 31, 2021].
- ECG Alert, 2020. Heart Monitoring Device | ECG Alert. <https://www.ecgalert.com> [Accessed on Jan. 25, 2021].
- El-Rashidy N, El-Sappagh S, Islam SMR, et al., 2020. End-to-end deep learning framework for coronavirus (COVID-19) detection and monitoring. *Electronics*, 9(9):1439. <https://doi.org/10.3390/electronics9091439>
- Endotronix Inc., 2021. Cordella System for Hemodynamic Monitoring. <https://endotronix.com/> [Accessed on June 21, 2021].
- Estimote, 2020. Workplace Safety with Wearables. <https://estimote.com/wearable> [Accessed on Jan. 25, 2021].
- E-takescare, 2021. Tucky: Wearable Thermometer & Movement Monitor. <http://www.e-takescare.com/en/> [Accessed on Feb. 4, 2021].
- European Centre for Disease Prevention and Control, 2020. Monitoring and Evaluation Framework for COVID-19 Response Activities in the EU/EEA and the UK. <https://www.ecdc.europa.eu/en/publications-data/covid-19-monitoring-and-evaluation-framework-response-activities> [Accessed on Dec. 19, 2020].
- European Commission, 2020. Jobs and Economy During the Coronavirus Pandemic. https://ec.europa.eu/info/live-work-travel-eu/coronavirus-response/jobs-and-economy-during-coronavirus-pandemic_en [Accessed on Dec. 17, 2020].
- Fadare OO, Okoffo ED, 2020. Covid-19 face masks: a potential source of microplastic fibers in the environment. *Sci Total Environ*, 737:140279. <https://doi.org/10.1016/j.scitotenv.2020.140279>
- Farrahi K, Emonet R, Cebrian M, 2014. Epidemic contact tracing via communication traces. *PLoS One*, 9(5):e95133. <https://doi.org/10.1371/journal.pone.0095133>

- Gaetani F, Primiceri P, Zappatore GA, et al., 2019. Hardware design and software development of a motion control and driving system for transradial prosthesis based on a wireless myoelectric armband. *IET Sci Meas Technol*, 13(3):354-362. <https://doi.org/10.1049/iet-smt.2018.5108>
- Garg L, Chukwu E, Nasser N, et al., 2020. Anonymity preserving IoT-based COVID-19 and other infectious disease contact tracing model. *IEEE Access*, 8:159402-159414. <https://doi.org/10.1109/ACCESS.2020.3020513>
- Ghasemi F, Hormozi-Nezhad MR, Mahmoudi M, 2015. A colorimetric sensor array for detection and discrimination of biothiols based on aggregation of gold nanoparticles. *Anal Chim Acta*, 882:58-67. <https://doi.org/10.1016/j.aca.2015.04.011>
- Giovannini G, Haick H, Garoli D, 2021. Detecting COVID-19 from breath: a game changer for a big challenge. *ACS Sens*, 6(4):1408-1417. <https://doi.org/10.1021/acssensors.1c00312>
- Girolami M, Mavilia F, Delmastro F, 2020. Sensing social interactions through BLE beacons and commercial mobile devices. *Perv Mob Comput*, 67:101198. <https://doi.org/10.1016/j.pmcj.2020.101198>
- Givertz MM, Stevenson LW, Costanzo MR, et al., 2017. Pulmonary artery pressure-guided management of patients with heart failure and reduced ejection fraction. *J Am Coll Cardiol*, 70(15):1875-1886. <https://doi.org/10.1016/j.jacc.2017.08.010>
- Grant MC, Geoghegan L, Arbyn M, et al., 2020. The prevalence of symptoms in 24, 410 adults infected by the novel coronavirus (SARS-CoV-2; COVID-19): a systematic review and meta-analysis of 148 studies from 9 countries. *PLOS ONE*, 15(6):e0234765. <https://doi.org/10.1371/journal.pone.0234765>
- Greenhalgh T, Koh GCH, Car J, 2020. Covid-19: a remote assessment in primary care. *BMJ*, 368:m1182. <https://doi.org/10.1136/bmj.m1182>
- Gupta M, Abdelsalam M, Mittal S, 2020. Enabling and enforcing social distancing measures using smart city and ITS infrastructures: a COVID-19 use case. <https://arxiv.org/abs/2004.09246>
- Hassantabar S, Stefano N, Ghanakota V, et al., 2020. Covid-Deep: SARS-CoV-2/COVID-19 test based on wearable medical sensors and efficient neural networks. <https://arxiv.org/abs/2007.10497>
- Hedayatipour A, Mcfarlane N, 2020. Wearables for the next pandemic. *IEEE Access*, 8:184457-184474. <https://doi.org/10.1109/ACCESS.2020.3029130>
- Hung PD, 2017. Estimating respiration rate using an accelerometer sensor. Proc 8th Int Conf on Computational Systems-Biology and Bioinformatics, p.11-14. <https://doi.org/10.1145/3156346.3156349>
- iFever, 2018. <http://www.vipose.com> [Accessed on Feb. 4, 2021].
- Immuni, 2020. <http://www.immuni.italia.it> [Accessed on Dec. 19, 2020].
- Indiegogo, 2018. iTherm. <http://www.ithermapp.com/> [Accessed on Feb. 4, 2021].
- Italian Institute of Technology, 2020. iFeel-You Bracelet. <https://www.iit.it/it/iit-vs-covid-19/ifeel-you-bracelet> [Accessed on Jan. 25, 2021].
- Jeong H, Rogers JA, Xu S, 2020. Continuous on-body sensing for the COVID-19 pandemic: gaps and opportunities. *Sci Adv*, 6(36):eabd4794. <https://doi.org/10.1126/sciadv.abd4794>
- Jeong S, Kuk S, Kim H, 2019. A smartphone magnetometer-based diagnostic test for automatic contact tracing in infectious disease epidemics. *IEEE Access*, 7:20734-20747. <https://doi.org/10.1109/ACCESS.2019.2895075>
- Kuhn C, Beck M, Strufe T, 2021. Covid notions: towards formal definitions—and documented understanding—of privacy goals and claimed protection in proximity-tracing services. *Online Soc Netw Media*, 22:100125. <https://doi.org/10.1016/j.osnem.2021.100125>
- Kumar SS, Dashtipour K, Abbasi QH, et al., 2021. A review on wearable and contactless sensing for COVID-19 with policy challenges. *Front Comms Net*, 2:636293. <https://doi.org/10.3389/frcmn.2021.636293>
- Labios L, 2021. Making Masks Smarter and Safer Against COVID-19. <https://ucsdnews.ucsd.edu/feature/making-masks-smarter-and-safer-against-covid-19> [Accessed on Feb. 2, 2021].
- Labs DI, 2020. Using WHOOP Wearable Technology to Predict COVID-19 Risk. <http://www.whoop.com/thelocker/predict-covid-19-risk/> [Accessed on Feb. 8, 2021].
- Larsen JR, Martin MR, Martin JD, et al., 2020. Modeling the onset of symptoms of COVID-19. *Front Publ Health*, 8:473. <https://doi.org/10.3389/fpubh.2020.00473>
- LG Group, 2020. LG PuriCare™ Wearable Air Purifier. https://www.lg.com/hk_en/puricare/lg-ap300awfa [Accessed on Feb. 11, 2021].
- Lief Therapeutics, 2019. https://www.getlief.com/healthcare_provider [Accessed on Feb. 10, 2021].
- LifeSignals, 2020. Companies Roll Out Remote COVID-19 Monitoring Tools to Free up Hospital Space. <https://lifesignals.com/covid19/> [Accessed on Jan. 25, 2021].
- Liu HP, Allen J, Zheng DC, et al., 2019. Recent development of respiratory rate measurement technologies. *Physiol Meas*, 40(7):07TR01. <https://doi.org/10.1088/1361-6579/ab299e>
- Liu S, Jiang YX, Striegel A, 2014. Face-to-face proximity estimation using Bluetooth on smartphones. *IEEE Trans Mob Comput*, 13(4):811-823. <https://doi.org/10.1109/TMC.2013.44>
- Mabo P, Victor F, Bazin P, et al., 2012. A randomized trial of long-term remote monitoring of pacemaker recipients (the COMPAS trial). *Eur Heart J*, 33(9):1105-1111. <https://doi.org/10.1093/eurheartj/ehr419>
- MediBioSense, 2020. VitalPatch. <https://www.medibiosense.com/vitalpatch/> [Accessed on Feb. 2, 2021].
- Meetoo D, Wong L, Ochieng B, 2019. Smart tattoo: technol-

- ogy for monitoring blood glucose in the future. *Br J Nurs*, 28(2):110-115.
<https://doi.org/10.12968/bjon.2019.28.2.110>
- Menni C, Valdes AM, Freidin MB, et al., 2020. Real-time tracking of self-reported symptoms to predict potential COVID-19. *Nat Med*, 26(7):1037-1040.
<https://doi.org/10.1038/s41591-020-0916-2>
- Miller DJ, Capodilupo JV, Lastella M, et al., 2020. Analyzing changes in respiratory rate to predict the risk of COVID-19 infection. *PLOS ONE*, 15(12):e0243693.
<https://doi.org/10.1371/journal.pone.0243693>
- Mishra T, Wang M, Metwally AA, et al., 2020. Pre-symptomatic detection of COVID-19 from smart watch data. *Nat Biomed Eng*, 4(12):1208-1220.
<https://doi.org/10.1038/s41551-020-00640-6>
- Mojsoska B, Larsen S, Olsen DA, et al., 2021. Rapid SARS-CoV-2 detection using electrochemical immunosensor. *Sensors*, 21(2):390.
<https://doi.org/10.3390/s21020390>
- Mondal MS, Roy K, Sarkar S, 2020. Design and development of wearable remote temperature monitoring device for smart tracking of COVID-19 fever. Proc 2nd Int Conf on IoT, Social, Mobile, Analytics & Cloud in Computational Vision & Bio-engineering, p.665-675.
- Moreddu R, Wolffsohn JS, Vigolo D, et al., 2020. Laser-inscribed contact lens sensors for the detection of analytes in the tear fluid. *Sens Actuat B Chem*, 317:128183.
<https://doi.org/10.1016/j.snb.2020.128183>
- Mullens W, Sharif F, Dupont M, et al., 2020. Digital health care solution for proactive heart failure management with the Cordella Heart Failure System: results of the SIRONA first-in-human study. *Eur J Heart Fail*, 22(10):1912-1919.
<https://doi.org/10.1002/ejhf.1870>
- NanoHack 3D, 2020. Covid-19: Developing High Tech Protective Masks. MedicalExpo e-Magazine.
<http://emag.medicaexpo.com/covid-19-development-of-high-tech-protective-masks/> [Accessed on Feb. 4, 2021].
- Nasajpour M, Pouriye S, Parizi RM, et al., 2020. Internet of Things for current COVID-19 and future pandemics: an exploratory study. *J Healthc Inform Res*, 4(4):325-364.
<https://doi.org/10.1007/s41666-020-00080-6>
- Nejad MAF, Bigdeli A, Hormozi-Nezhad MR, 2020. Wide color-varying visualization of sulfide with a dual emissive ratiometric fluorescence assay using carbon dots and gold nanoclusters. *Microchem J*, 157:104960.
<https://doi.org/10.1016/j.microc.2020.104960>
- Nymi Inc., 2021. Nymi | Workplace Wearable.
<https://www.nymi.com> [Accessed on Feb. 11, 2021].
- Oura, 2020. Oura Ring: Accurate Health Information Accessible to Everyone. <https://ouraring.com> [Accessed on Jan. 25, 2021].
- Paek J, Kim J, Govindan R, 2010. Energy-efficient rate-adaptive GPS-based positioning for smartphones. Proc 8th Int Conf on Mobile Systems, Applications, and Services, p.299-314.
<https://doi.org/10.1145/1814433.1814463>
- Paramasivam A, Priyadharsini JV, Raghunandhakumar S, et al., 2020. A novel COVID-19 and its effects on cardiovascular disease. *Hypertens Res*, 43(7):729-730.
<https://doi.org/10.1038/s41440-020-0461-x>
- Partitalia, 2020a. Close-to-me. <https://www.partitalia.com/en/close-to-me/> [Accessed on Jan. 25, 2021].
- Partitalia, 2020b. VITA. <https://www.partitalia.com/en/vita/> [Accessed on Jan. 25, 2021].
- Patil M, Madankar A, Khandait PD, 2019. Heart rate monitoring system. Proc 5th Int Conf on Advanced Computing & Communication Systems, p.574-576.
<https://doi.org/10.1109/ICACCS.2019.8728501>
- PEPP-PT, 2020. Pan-European Privacy-Preserving Proximity Tracing. PEPP-PT Documentation.
<https://github.com/pepp-pt> [Accessed on May 31, 2021].
- Perl L, Soifer E, Bartunek J, et al., 2019. A novel wireless left atrial pressure monitoring system for patients with heart failure, first ex-vivo and animal experience. *J Cardiovasc Trans Res*, 12(4):290-298.
<https://doi.org/10.1007/s12265-018-9856-3>
- PMD Solutions, 2021. RespiraSense | Innovation Agency.
<https://www.innovationagencyexchange.org.uk/solutions/respirasense> [Accessed on Feb. 2, 2021].
- Polenta A, Rignanese P, Sernani P, et al., 2020. An Internet of Things approach to contact tracing—the BubbleBox system. *Information*, 11(7):347.
<https://doi.org/10.3390/info11070347>
- PRIVATICS Team Inria and Fraunhofer AISEC, 2021. ROBust and Privacy-PresERving Proximity Tracing Protocol. <https://github.com/ROBERT-proximity-tracing/documents> [Accessed on May 31, 2021].
- Quy VN, Duy DT, Kien DT, et al., 2019. Wearable device for monitoring heart rate based on low-cost piezoresistive sensor. Proc 8th Int Conf on Modern Circuits and Systems Technologies, p.1-4.
<https://doi.org/10.1109/MOCAS.2019.8741734>
- Rabiee N, Bagherzadeh M, Ghasemi A, et al., 2020. Point-of-use rapid detection of SARS-CoV-2: nanotechnology-enabled solutions for the COVID-19 pandemic. *Int J Mol Sci*, 21(14):5126.
<https://doi.org/10.3390/ijms21145126>
- Rajasekar SJS, 2021. An enhanced IoT based tracing and tracking model for COVID-19 cases. *SN Comput Sci*, 2:42.
<https://doi.org/10.1007/s42979-020-00400-y>
- Razer, 2020. The World's Smartest Mask - Project Hazel. <https://www.razer.com/concepts/razer-project-hazel> [Accessed on Feb. 11, 2021].
- Rights Office for Civil, 2020. Notification of Enforcement Discretion for Telehealth. <https://www.hhs.gov/hipaa/for-professionals/special-topics/emergency-preparedness/notification-enforcement-discretion-telehealth/index.html> [Accessed on Dec. 19, 2020].
- Safe Spacer, 2020. Safe Spacer - Wearable Social Distance Monitor by IK Multimedia. <https://www.safespacer.net/> [Accessed on Jan. 25, 2021].

- Sandhu AT, Goldhaber-Fiebert JD, Owens DK, et al., 2016. Cost-effectiveness of implantable pulmonary artery pressure monitoring in chronic heart failure. *JACC Heart Fail*, 4(5):368-375.
<https://doi.org/10.1016/j.jchf.2015.12.015>
- Sapiezynski P, Stopczynski A, Wind DK, et al., 2016. Inferring person-to-person proximity using WiFi signals. <https://arxiv.org/abs/1610.04730>
- Satoh H, Suzuki M, Tahiro Y, et al., 2013. Ambient sound-based proximity detection with smartphones. Proc 11th ACM Conf on Embedded Networked Sensor Systems, p.1-2. <https://doi.org/10.1145/2517351.2517436>
- Seshadri DR, Davies EV, Harlow ER, et al., 2020. Wearable sensors for COVID-19: a call to action to harness our digital infrastructure for remote patient monitoring and virtual assessments. *Front Dig Health*, 2:8.
<https://doi.org/10.3389/fdgth.2020.00008>
- Shahshahani A, Nafchi DR, Zilic Z, 2017. Ultrasound sensors and its application in human heart rate monitoring. IEEE Int Symp on Circuits and Systems, p.1-4.
<https://doi.org/10.1109/ISCAS.2017.8050899>
- Sharma P, Intiaz SA, Rodriguez-Villegas E, 2019. Acoustic sensing as a novel wearable approach for cardiac monitoring at the wrist. *Sci Rep*, 9(1):20079.
<https://doi.org/10.1038/s41598-019-55599-5>
- Simmhan Y, Rambha T, Khochare A, et al., 2020. GoCoronaGo: privacy respecting contact tracing for COVID-19 management. *J Ind Inst Sci*, 100:623-646.
<https://doi.org/10.1007/s41745-020-00201-5>
- Skiin, 2019. Skiin Connected Care System. <https://skiin.com/> [Accessed on Feb. 20, 2021].
- Son LP, Thu NTA, Kien NT, 2017. Design an IoT wrist-device for SpO₂ measurement. Int Conf on Advanced Technologies for Communications, p.144-149.
<https://doi.org/10.1109/ATC.2017.8167605>
- Stanford MG, Li JT, Chen YD, et al., 2019. Self-sterilizing laser-induced graphene bacterial air filter. *ACS Nano*, 13(10):11912-11920.
<https://doi.org/10.1021/acsnano.9b05983>
- Sun RX, Wang W, Xue MH, et al., 2020. An empirical assessment of global COVID-19 contact tracing applications. <https://arxiv.org/abs/2006.10933>
- Tadi MJ, Koivisto T, Pänkäälä M, et al., 2014. Accelerometer-based method for extracting respiratory and cardiac gating information for dual gating during nuclear medicine imaging. *Int J Biomed Imag*, 2014:690124.
<https://www.hindawi.com/journals/ijbi/2014/690124/>
- TADSAFE, 2019. Temperature Alert Device - TADTM. <https://tadsafe.com/> [Accessed on Feb. 4, 2021].
- Tedeschi P, Bakiras S, di Pietro R, 2020. IoTrace: a flexible, efficient, and privacy-preserving IoT-enabled architecture for contact tracing.
<https://arxiv.org/abs/2007.11928>
- TempTraq, 2021. Continuous, Real-Time Body Temperature Monitoring System. <https://temptraq.healthcare/> [Accessed on Feb. 4, 2021].
- TraceTogether Tokens, 2020. Token Go Where. <https://token.gowhere.gov.sg/> [Accessed on Feb. 10, 2021].
- Tripathy AK, Mohapatra AG, Mohanty SP, et al., 2020. EasyBand: a wearable for safety-aware mobility during pandemic outbreak. *IEEE Consum Electron Mag*, 9(5): 57-61.
<https://doi.org/10.1109/MCE.2020.2992034>
- UK Health Security Agency, 2020. COVID-19: Guidance for Households with Possible Coronavirus Infection. <https://www.gov.uk/government/publications/covid-19-stay-at-home-guidance> [Accessed on Dec. 19, 2020].
- Vectorious Inc., 2021. V-LAP Datasheet. Vectorious Medical Technologies. <https://vectoriousmedtech.com/products/> [Accessed on June 21, 2021].
- Versteeg H, Pedersen SS, Mastenbroek MH, et al., 2014. Patient perspective on remote monitoring of cardiovascular implantable electronic devices: rationale and design of the REMOTE-CIED study. *Neth Heart J*, 22(10): 423-428.
<https://doi.org/10.1007/s12471-014-0587-z>
- Visconti P, Gaetani F, Zappatore GA, et al., 2018. Technical features and functionalities of Myo armband: an overview on related literature and advanced applications of myoelectric armbands mainly focused on arm prostheses. *Int J Smart Sens Intell Syst*, 11(1):1-25.
<https://doi.org/10.21307/ijssis-2018-005>
- Visconti P, de Fazio R, Costantini P, et al., 2019. Arduino-based solution for in-carabandoned infants' controlling remotely managed by smartphone application. *J Commun Softw Syst*, 15(2):89-100.
<https://doi.org/10.24138/jcomss.v15i2.691>
- Visconti P, de Fazio R, Costantini P, et al., 2020. Innovative complete solution for health safety of children unintentionally forgotten in a car: a smart Arduino-based system with user app for remote control. *IET Sci Meas Technol*, 14(6):665-675.
<https://doi.org/10.1049/iet-smt.2018.5664>
- VitalConnect, 2020. VitalPatch. <https://vitalconnect.com/solutions/vitalpatch/> [Accessed on Feb. 2, 2021].
- VivaLNK, 2020. VivaLNK Fever Scout. <http://vivalnk.com.cn/index.php/List/index/cid/172.html> [Accessed on Feb. 4, 2021].
- Walton AS, Krum H, 2005. The Heartpod implantable heart failure therapy system. *Heart Lung Circ*, 14(2):S31-S33.
<https://doi.org/10.1016/j.hlc.2005.09.003>
- Wang WY, Ouaras K, Rutz AL, et al., 2020. Inflight fiber printing toward array and 3D optoelectronic and sensing architectures. *Sci Adv*, 6(40):eaba0931.
<https://doi.org/10.1126/sciadv.aba0931>
- WHO (World Health Organization), 2020. WHO Coronavirus Disease (COVID-19) Dashboard. <https://covid19.who.int/> [Accessed on Dec. 19, 2020].
- Xiaomi, 2020. Xiaomi Smart Mask: Monitoraggio in Tempo Reale del Respiro. MIUI Italia. <https://www.miui.it/2020/02/19/xiaomi-smart-mask-brevetto/> [Accessed on Feb. 8, 2021].

- Xue JW, Huang YH, Du X, et al., 2015. Design of a wearable device for monitoring SpO₂ continuously. IEEE 12th Int Conf on Ubiquitous Intelligence and Computing and IEEE 12th Int Conf on Autonomic and Trusted Computing and IEEE 15th Int Conf on Scalable Computing and Communications and Its Associated Workshops, p.1253-1257. <https://doi.org/10.1109/UIC-ATC-ScalCom-CBD Com-IoP.2015.227>
- Yim W, Cheng DY, Patel SH, et al., 2020. KN95 and N95 respirators retain filtration efficiency despite a loss of dipole charge during decontamination. *ACS Appl Mater Interf*, 12(49):54473-54480. <https://doi.org/10.1021/acsami.0c17333>
- Yousif M, Hewage C, Nawaf L, 2021. IoT technologies during and beyond COVID-19: a comprehensive review. *Fut Int*, 13(5):105. <https://doi.org/10.3390/fi13050105>