

RESEARCH

Open Access



Dynamic dual threshold cooperative spectrum sensing for cognitive radio under noise power uncertainty

Runze Wan^{1,2}, Lixin Ding^{1*}, Naixue Xiong³, Wanneng Shu⁴ and Li Yang²

*Correspondence:

lxding@whu.edu.cn

¹ School of Computer Science, Wuhan University, Wuhan 430072, China

Full list of author information is available at the end of the article

Abstract

The spectrum sensing performance depends on the accuracy of the detection about whether primary users are busy or idle. Previous studies on cognitive radio spectrum sensing have shown that the cooperation between secondary users can improve their spectrum detection performance in real cognitive networks. Aiming at the problem of threshold mismatch of energy detectors under noise power uncertainty, a cooperative spectrum sensing method with dynamic dual threshold is proposed. Firstly, the utility function is defined with the objective of minimizing the error probability of spectrum sensing, and the optimum threshold of energy detector is derived. Secondly, in order to mitigate the influence derived from noise uncertainty, an effective dynamic dual threshold adjustment mechanism is presented, and the optimizing combinative fusion rule is discussed with the prerequisite of the minimum global error probability. In addition, in view of insufficient number of cognitive users whose sensing results lie in decision zones, the parameter of credibility is defined to choose the secondary users with reliable local detection for final fusion. Simulation results show that our proposed method can mitigate the influence of noise uncertainty and increase the spectrum sensing accuracy compared with other existing methods.

Keywords: Cooperative spectrum sensing, Cognitive radio, Energy detection, Noise power uncertainty

Introduction

The rapid development of wireless communications has brought endless new types of services or applications for human beings. The emergence of many kinds of communication equipments makes the public frequency band more and more crowded [1]. At present, most of the wireless communication systems employ fixed spectrum allocation mechanism. Only authorized users can be allowed to access the corresponding authorized spectrum resources, which will lead to inefficient usage of the licensed spectrum. From the report issued by International Telecommunication Union (ITU), there are still plenty of free spectrum resources within certain authorized bands at specific temporal and spatial scenarios. In cognitive radio (CR) system, by dynamically adjusting transmission power, carrier frequency, modulation and other parameters, SUs can utilize the spectrum holes as well as avoid interference with primary users (PUs). By applying cognitive radio technology, the SUs can fully access free authorized bands and apply suitable

flexibility in handling spectrum scarcity problem [2]. Meanwhile, spectrum resource sharing is regarded as one of the key technologies to ensure the channel quality and the effective utilization of authorized bandwidth resources.

Cognitive terminals usually possess the functions of sharing and managing spectrum resources and perceiving the surrounding circumstance. Spectrum sensing is one of the most important technologies in CR system as well as the premise of channel estimation and spectrum resource allocation. CR system can judge whether the current authorized user band is available by spectrum detection. Therefore, it is important for efficient operation of cognitive radio systems to perceive the working state of authorized channels accurately [3]. However, the detection performance is seriously affected by ambient noise, which can easily lead to detection errors and interference to PUs. To ensure the coexistence of the cognitive radio network and the primary network, the absolute priority of the PUs to access the licensed channel must be guaranteed [4]. If the accuracy of spectrum detection is not high, it will cause serious interference to the main network users, which will limit the development and application of cognitive radio technology. Only by accurately sensing the spectrum usage in wireless environment can it be possible to provide a reliable basis for the subsequent dynamic spectrum sharing, so that cognitive radio technology can be more widely developed and applied. Therefore, it requires that secondary users (SUs) should have a high accuracy spectrum detection function. In most of cooperative spectrum detection algorithms, the threshold value of energy detector is easily affected by noise uncertainty, thus deteriorating the spectrum detection performance [5]. In this paper, we propose a dynamic dual threshold cooperative spectrum sensing method to improve detection accuracy and alleviate the sensing failure problem under noise power uncertainty.

The remainder of this paper is organized as follows. In “[Related work](#)” section, related work about spectrum sensing in cognitive radio network is discussed. In “[System model and proposed method](#)” section, we describe the proposed cooperative spectrum sensing scheme in detail, along with the model and all relevant assumptions. The performance evaluation and experimental results are shown in “[Results and discussion](#)” section, and the conclusions are drawn in “[Conclusions](#)” section.

Related work

The objective of cognitive radio technology is to allow unauthorized SUs to access free authorized bands while causing limited interference to PUs [6]. By sensing the frequency band and taking advantage of that band opportunistically, the secondary system can be provided with the ability to operate in dynamic and unpredictable environments [7]. Hence, the optimization strategies to improve the efficiency and reliability of spectrum sensing are crucial research topics.

Owing to the characteristics of simplicity and low computational cost, energy detection method is taken as the most commonly applied technique [8], and the appropriate energy threshold can determine whether the PU is present or not. In [9], the authors conduct the derivation to obtain the optimal voting threshold of energy detector in cooperative spectrum sensing, and proposed a fast spectrum sensing algorithm. The analysis in [10] was focused on decision threshold formula for energy detection of narrowband signals, and the optimal threshold of narrowband system was proven be

obtained by taking into account of the noise power and the false alarm probability. In [11], the authors studied the energy detection based on wideband signal, and proposed the optimal decision threshold with closed expression by utilizing the minimum error probability criterion.

In view of the problem that the decision threshold is difficult to be determined in traditional energy detection method [12], the dual-threshold energy detection algorithm has been considered in various papers. In [13], Umebayashi et al. proposed a dual-threshold energy detection algorithm for hierarchical cooperative spectrum sensing. To reduce the communication overhead, they presented a softened hard combination scheme to solve the problem of perceived failure as well as improve the detection performance of the system. In [14], Bagwari et al. evaluated the performance of the cyclostationary based sensing method and adaptive spectrum sensing, and presented a reliable spectrum sensing scheme using dual detectors. To improve the spectrum detection performance and reduce the algorithm complexity under low signal-to-noise ratio (SNR), the authors in [15] applied wavelet transform spectrum sensing technology into the spread spectrum signal sensing systems. However, the sensing performance of the energy detector will be affected seriously by the noise uncertainty, and it will result in high error probability of spectrum sensing.

In wireless environment, cooperative sensing can reduce the influence of shadow and multipath fading effectively [16]. Through the natural spatial diversity gain, the detection probability will be greatly improved in the complex wireless circumstance, and the PU can be better protected. According to [17], Atapattu et al. proposed a data fusion strategy with multiple cognitive relays. Although the difference of transmission channel for each cognitive node being considered, it requires all SUs to participate in cooperation with the result of high transmission overload. In [18], Maleki et al. considered the combination of sleeping and censoring to minimize the energy depletion, in which the real-time performance of the system may be impacted due to the increase of number of samples for the sake of credible decision. In [19], Singh et al. presented a cooperative spectrum sensing mechanism based on multiple antennas, and they derived tight bounds of the probabilities of false alarm and missed detection. However, such scheme has high computational complexity and needs more sensing time.

Under the condition of known feature of PU's signal and Gaussian white noise circumstance, the performance of energy detection is proven to be of practical advantage [20]. In [21], Tandra et al. have proposed a robust statistic approach, and derived the minimum SNR threshold for robust detection under noise power uncertainty model. The impact of noise power estimation error on the decision threshold of energy detection is analyzed through theory and simulations. In [22], Deepak et al. discussed the use of filter bank method with discrete-time Fourier transform in a dynamic scenario to minimize the error probability of spectrum sensing in presence of noise uncertainty. In [23], the maximum likelihood estimation method is applied for estimating the noise variance, and the performance of the energy detection with estimated noise power is analyzed. As the noise power is known, energy detection can achieve robust capability at any low SNR by increasing the number of samplings. However, the actual noise power is usually uncertain, and most of researches on adaptive cooperative spectrum sensing do not consider the noise power uncertainty.

System model and proposed method

System model

We consider a fusion center (FC) or base station and N SUs to participate in cooperative spectrum sensing. FC is responsible for channel allocation and management of all cooperative cognitive users [24]. Assuming that the local sensing process of each cognitive user is independent, and the energy detection method is exploited for decision making. The PU detection for a given received signal $x(k)$ can be formulated into the statistical problem, in which two hypotheses H_0 and H_1 for receiving signals can be represented as the presence or absence of PU. Thus, it can be formulated as follows:

$$x_i(k) = \begin{cases} u_i(k), & H_0 \\ h_i(k)s(k) + u_i(k), & H_1 \end{cases} \quad (1)$$

where PU signal $s(k)$ is assumed as complex circular symmetric Gaussian random variable with zero mean and variance σ_s^2 , and noise sample $u_i(k)$ is assumed to be a complex circular symmetric Gaussian random variable with mean zero and variance σ_{ui}^2 . Besides, $h_i(k)$ is channel gain between the i -th SU and PU, which is assumed to be a complex circular symmetric Gaussian random variable with zero mean and variance δ_i .

By using energy detection method for spectrum sensing, SUs will calculate the accumulated energy in terms of M samples of the observation signal of bandwidth W during the period of t seconds, and the received energy collected over the observation samples at SU i will be given by [25]: $E_i = \frac{1}{M} \sum_{k=1}^M |x_i(k)|^2$.

According to the central limit theorem [26], if the number of samples N is sufficiently large, the test statistic E_i is asymptotically Gaussian distributed, and its distributions at the i -th SU, under the two hypotheses H_0 and H_1 , are given as

$$\begin{cases} \mu_{i0} = \sigma_{ui}^2 \\ \delta_{i0}^2 = \frac{2}{M} \sigma_{ui}^4 \end{cases} \quad (2)$$

$$\begin{cases} \mu_{i1} = \sigma_{ui}^2 + P_i \\ \delta_{i1}^2 = \frac{2}{M} (\sigma_{ui}^2 + P_i)^2 \end{cases} \quad (3)$$

where $P_i = \delta_i \sigma_s^2$ denoting the received PU signal power at the i -th SU.

Dynamic double threshold

In traditional methods of energy detection technology, SUs usually make decisions by comparing the received signals with a prior threshold [9]. The decision of H_0 or H_1 depends on whether the received signal power of PU is higher or lower than the threshold [27]. According to the above decision rule and given threshold value λ_i , the accuracy of final decision results is closely related to the fusion method, and the false alarm probability p_f and detection probability p_d can be obtained as following [28]:

$$\begin{cases} p_f = \Pr\{E_i > \lambda_i|H_0\} = Q\left(\sqrt{\frac{M}{2}}\left(\frac{\lambda_i - \sigma_{ui}^2}{\sigma_i^2}\right)\right) \\ p_d = \Pr\{E_i > \lambda_i|H_1\} = Q\left(\sqrt{\frac{M}{2}}\left(\frac{\lambda_i - (\sigma_{ui}^2 + P_i)}{\sigma_{ui}^2 + P_i}\right)\right) \end{cases} \quad (4)$$

where $Q(\cdot)$ denotes a Gaussian tail function which is defined as $Q(t) = \frac{1}{\sqrt{2\pi}} \int_t^\infty \exp\left(-\frac{x^2}{2}\right) dx$.

For a single SU, the error probability includes two aspects: one is the false alarm probability when the PU does not exist, and the other is the probability of missed detection when the PU exists. Therefore, the objective function can be constructed as follows:

$$\begin{aligned} U = p(H_0)p_f + p(H_1)(1 - p_d) = p(H_0)Q\left(\sqrt{\frac{M}{2}}\left(\frac{\lambda_i - \sigma_{ui}^2}{\sigma_{ui}^2}\right)\right) + \\ p(H_1)\left[1 - Q\left(\sqrt{\frac{M}{2}}\left(\frac{\lambda_i - (\sigma_{ui}^2 + P_i)}{\sigma_{ui}^2 + P_i}\right)\right)\right] \end{aligned} \quad (5)$$

where $p(H_0)$ and $p(H_1)$ indicate the probabilities of the idle and the busy states of the PU respectively, and $p(H_0) + p(H_1) = 1$.

According to the partial derivative of function U with respect to variable λ_i , we have

$$\begin{aligned} \frac{\partial U}{\partial \lambda_i} = -\frac{p(H_0)}{2\sigma_{ui}^2} \sqrt{\frac{M}{\pi}} \exp\left[-\frac{M}{4}\left(\frac{\lambda_i}{\sigma_{ui}^2} - 1\right)^2\right] \\ + \frac{p(H_1)}{2(\sigma_{ui}^2 + P_i)} \sqrt{\frac{M}{\pi}} \exp\left[-\frac{M}{4}\left(\frac{\lambda_i - (\sigma_{ui}^2 + P_i)}{\sigma_{ui}^2 + P_i}\right)^2\right]. \end{aligned} \quad (6)$$

Next, the second derivative can be written as:

$$\begin{aligned} \frac{\partial^2 U}{\partial \lambda_i^2} = \frac{p(H_0)M^{\frac{3}{2}}}{8\sqrt{\pi}\sigma_{ui}^4} \times \left(\frac{\lambda_i}{\sigma_{ui}^2} - 1\right) \times \exp\left(-\frac{M}{4}\left(\frac{\lambda_i}{\sigma_{ui}^2} - 1\right)^2\right) \\ - \frac{p(H_1)M^{\frac{3}{2}}}{8\sqrt{\pi}\sigma_{ui}^4} \times \left(\frac{\lambda_i}{\sigma_{ui}^2 + P_i} - 1\right) \times \exp\left(-\frac{M}{4}\left(\frac{\lambda_i}{\sigma_{ui}^2 + P_i} - 1\right)^2\right). \end{aligned} \quad (7)$$

Since the SUs are generally satisfied with $p_f < 0.5$ and $p_d > 0.5$, the local false alarm probability can be written as:

$$p_f = Q\left(\sqrt{\frac{M}{2}}\left(\frac{\lambda_i}{\sigma_{ui}^2} - 1\right)\right) = \frac{1}{2} \operatorname{erfc}\left(\frac{\sqrt{M}}{2}\left(\frac{\lambda_i}{\sigma_{ui}^2} - 1\right)\right) < 0.5. \quad (8)$$

According to the properties of complementary error function $erfc(x)$, if independent variable $x > 0$, the function value is less than 1. As a result, $\lambda_i > \sigma_{ui}^2$. Similarly, if $x < 0$, the value of $erfc(x)$ is greater than 1. Since $p_d > 0.5$, we can obtain $\lambda_i < \sigma_{ui}^2 + P_i$. Based on the above analysis, we get $\frac{\partial^2 U}{\partial \lambda_i^2} > 0$, and it means that there exists a minimum value of U with regard to λ_i .

Suppose $\frac{\partial U}{\partial \lambda_i} = 0$, the optimal λ can be obtained as follows

$$\lambda_{i,opt} = \sigma_{ui}^2 \times \left(1 - \frac{\sigma_{ui}^2}{2\sigma_{ui}^2 + P_i} \right) \times \left\{ \frac{4}{M} \times \left(\frac{2\sigma_{ui}^2}{P_i} + 1 \right) \times \left[\ln \left(\frac{p(H_0)}{p(H_1)} \right) + \ln \left(1 + \frac{P_i}{\sigma_{ui}^2} \right) \right] + 1 \right\}^{1/2} \tag{9}$$

Traditionally, test statistics is usually conducted with a fixed single threshold, which will be ascertained with difficulty. Energy detection is the most commonly used method, which is derived from simplicity, without the prior knowledge of the signal, and easy implementation about hardware. However, the detection performance of the traditional energy detection algorithm decreases sharply under the condition of low signal-to-noise ratio. Practically, the noise uncertainty problem will increase the possibility of false detection, which affects the priority of PU and enhance the communication overheads [29, 30]. Generally, it is assumed that the noise power at the receiver is deterministic and theoretical estimation of noise variance is possible. However, in real environments, noise power will vary over time and noise uncertainty exists in practice may cause deterioration of detection performance. Especially as the noise uncertainty increases, the uncertainty of the noise will lead to the fluctuation of the decision statistic.

In general, it is assumed that the noise power of the receiver is deterministic. However, in real environment, noise includes not only Gauss white noise, but also some other interference [31]. Moreover, the noise power changes with time and the relative position of the receiver and receiver in a certain range. This kind of noise instability is called noise uncertainty, which can lead to poor detection performance, i.e., either detection probability decreases or false alarm probability increases. To mitigate the problem caused by noise uncertainty, we proposed an adaptive dual threshold energy detector in accordance with the optimal single threshold value obtained. As can be seen as Fig. 1, the dual threshold is applied to decide whether PUs are present.

We assume that the range of noise is $\pm\theta_i$ dB and the noise uncertainty model in [32] is exploited. Then, the actual noise power $\hat{\sigma}_{ui}^2$ is uniformly distributed in the following range:

$$\hat{\sigma}_{ui}^2 \in \left[\frac{1}{\psi_i} \sigma_{ui}^2, \psi_i \sigma_{ui}^2 \right] \tag{10}$$

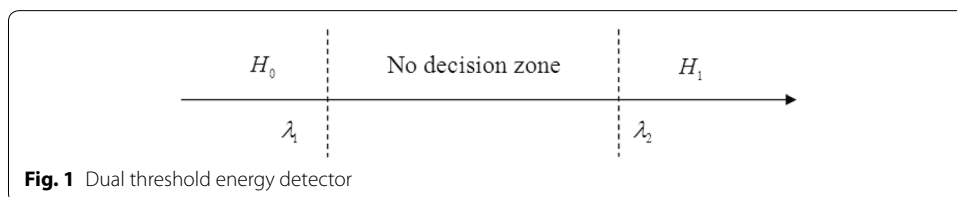

Fig. 1 Dual threshold energy detector

where the real noise power $\hat{\sigma}_u^2$ fluctuates on the expected noise power σ_u^2 , $\psi_i \in [10^{-\theta_i/10}, 10^{\theta_i/10}]$ and $\psi_i > 1$.

Therefore, the parameter ψ can be employed to quantify the noise power uncertainty.

$$\psi_i = \frac{\hat{\sigma}_{ui}^2}{\sigma_{ui}^2}. \tag{11}$$

For homogeneous SUs, where $\psi_i = \psi$ in addition to $\sigma_{ui}^2 = \sigma_u^2$, and the upper and lower bounds of noise uncertainty are represented as $\sigma_H^2 = \psi\sigma_u^2$ and $\sigma_L^2 = \frac{1}{\psi}\sigma_u^2$. If $\hat{\sigma}_u^2 \in [\sigma_u^2, \sigma_H^2]$, the actual noise power is higher than the nominal value. In this case, the actual false alarm probability will be higher than the preset target value under constant false-alarm rate criterion [33]. It means that the probability of SU accessing idle spectrum will decrease, and the throughput of secondary system decreases severely. Otherwise, $\hat{\sigma}_u^2 \in [\sigma_L^2, \sigma_u^2]$ and the actual noise power may be significantly lower than the nominal value. The detection signal power will be lower than the threshold value, which may lead to the probability of missed detection when PU is present. Therefore, the threshold value can be modified as following:

$$\lambda_1 = \sigma_H^2 \times \left\{ 1 + \left[(2\gamma + 1) \left(1 - \frac{4}{M\gamma} \ln \left(\frac{p(H_1)}{p(H_0)} \cdot \frac{1}{\sqrt{2\gamma + 1}} \right) \right) \right]^{1/2} \right\} = \frac{\tau}{\psi} \sigma_u^2 \tag{12}$$

$$\lambda_2 = \sigma_L^2 \times \left\{ 1 + \left[(2\gamma + 1) \left(1 - \frac{4}{M\gamma} \ln \left(\frac{p(H_1)}{p(H_0)} \cdot \frac{1}{\sqrt{2\gamma + 1}} \right) \right) \right]^{1/2} \right\} = \psi \tau \sigma_u^2 \tag{13}$$

where $\tau = \left(1 - \frac{\sigma_{ui}^2}{2\sigma_{ui}^2 + P_i} \right) \times \left\{ \frac{4}{M} \times \left(\frac{2\sigma_{ui}^2}{P_i} + 1 \right) \times \left[\ln \left(\frac{p(H_0)}{p(H_1)} \right) + \ln \left(1 + \frac{P_i}{\sigma_{ui}^2} \right) \right] + 1 \right\}^{1/2}$.

If the detected values is greater than the upper threshold λ_2 or less than lower threshold λ_1 , signal absent or present will be declared respectively. In addition, the energy statistic lying between two thresholds are treated as the “no decision” zone. With the increase of noise uncertainty, ψ tends to be infinite and most of the test statistics will be in a confused area. In such scenario, all the decision results depend on the previous channel observation state while the current channel information does not contribute to the decision results. In the following section, the optimal number of cooperative users is considered to improve the spectrum sensing performance.

Determination of k_{opt}

Under the condition of dual thresholds, we need to consider the number of nodes in determining regions and no decision zones, as well as the impact on perception accuracy. In real application, noise power will be affected by other systems and environmental factors, resulting in the dynamic change of noise variance over time and location in a certain range. The noise uncertainty can also lead to serious degradation of detection performance. Or, the actual noise power may be significantly lower than the nominal value, so the existence of PU can not be detected correctly, leading to missed detection. Therefore, in order to take into account the accuracy and efficiency of the system, it is necessary to theoretically analyze the solution of the voting threshold under the

condition that the total error rate of spectrum sensing arrive the minimum. Moreover, when the number of cognitive nodes satisfying the dual threshold requirement is insufficient, appropriate strategies should be taken to ensure the detection accuracy.

In cooperative spectrum sensing, the number of cognitive users is related with the sensing performance [34, 35]. However, plenty of participant SUs will not only lead to higher computational complexity and system overhead, but also make more detected values of cooperative users lie between the fuzzy regions in conventional dual threshold method at low SNR. Owing to the lower overhead and easy to implement, k-out-of-N rule is regarded as fusion scheme for combining the local binary decisions. Most traditional k-out-of-N criterion uses $k = \lceil N/2 \rceil$ as MAJORITY fusion rule, and actually which is not the optimal manner [36]. In [37], the performance of fusion rules is analyzed, and the experiment results verify that the total number of cooperated SUs vary with time. If the value of k is adapted with the change of N , the accuracy of spectrum detection decision can be effectively improved, especially in the case of seriously disturbed reporting channels.

Based on the definition of single threshold energy detection, the probabilities of PU detection and false alarm can be calculated respectively, with respect to the test statics in decision zone. However, σ_u^2 is unknown in the presence of noise uncertainty. To maintain the constraint on the false alarm probability for noise variance in the known interval, we analyze the false alarm probability and the detection probability in the worst case.

Hence, under H_0 , the false alarm probability p'_f , channel utilization probability p'_a and no decision probability Θ_0 can be calculated, respectively, as

$$p'_f = \Pr\{E_i > \lambda_2 | H_0\} = \max_{\sigma_u^2 \in [\frac{1}{\psi} \hat{\sigma}_u^2, \psi \hat{\sigma}_u^2]} Q\left(\frac{\lambda_2 - \mu_{i0}}{\delta_{i0}}\right) = Q\left(\sqrt{\frac{M}{2}} \left(\frac{\lambda_2 - \psi \hat{\sigma}_u^2}{\psi \hat{\sigma}_u^2}\right)\right) \tag{14}$$

$$p'_a = \Pr\{E_i < \lambda_1 | H_0\} = 1 - \max_{\sigma_u^2 \in [\frac{1}{\psi} \hat{\sigma}_u^2, \psi \hat{\sigma}_u^2]} Q\left(\frac{\lambda_1 - \mu_{i0}}{\delta_{i0}}\right) = 1 - Q\left(\sqrt{\frac{M}{2}} \left(\frac{\lambda_1 - \psi \hat{\sigma}_u^2}{\psi \hat{\sigma}_u^2}\right)\right) \tag{15}$$

$$\Theta_0 = \Pr\{\lambda_1 \leq E_i \leq \lambda_2 | H_0\} = 1 - p'_f - p'_a \tag{16}$$

In addition, under H_1 , the detection probability p'_d , the missed detection probability p'_m and no decision probability Θ_1 can be given, respectively, as

$$p'_d = \Pr\{E_i > \lambda_2 | H_1\} = \min_{\sigma_u^2 \in [\frac{1}{\psi} \hat{\sigma}_u^2, \psi \hat{\sigma}_u^2]} Q\left(\frac{\lambda_2 - \mu_{i1}}{\delta_{i1}}\right) = Q\left(\sqrt{\frac{M}{2}} \left(\frac{\psi \lambda_2 - (\hat{\sigma}_u^2 + P_i)}{\hat{\sigma}_u^2 + P_i}\right)\right) \tag{17}$$

$$p'_m = \Pr\{E_i < \lambda_1 | H_1\} = 1 - \min_{\sigma_u^2 \in [\frac{1}{\psi} \hat{\sigma}_u^2, \psi \hat{\sigma}_u^2]} Q\left(\frac{\lambda_1 - \mu_{i1}}{\delta_{i1}}\right) = 1 - Q\left(\sqrt{\frac{M}{2}} \left(\frac{\psi \lambda_1 - (\hat{\sigma}_u^2 + P_i)}{\hat{\sigma}_u^2 + P_i}\right)\right) \tag{18}$$

$$\Theta_1 = \Pr\{\lambda_1 \leq E_i \leq \lambda_2 | H_1\} = 1 - p'_d - p'_m \tag{19}$$

Next, the optimal voting value k should be investigated. Under a certain SNR environment, it is assumed that n out of N cooperating SUs are available for transmitting their decisions to FC. The number of n is variable with the change of environment. If the optimal voting rule for cooperative spectrum sensing with the variable n , the influence of noise uncertainty on detection performance can be avoided as far as possible. With k -out-of- N rule, the global false alarm probability Q_f and detection probability Q_d can be estimated as

$$\begin{cases} Q_d = 1 - \sum_{n=0}^N \binom{N}{n} (1 - \Theta_1)^n \Theta_1^{N-n} \sum_{l=k}^n \binom{n}{l} (p'_m)^l (1 - p'_m)^{n-l} \\ Q_f = 1 - \sum_{n=0}^N \binom{N}{n} (1 - \Theta_0)^n \Theta_0^{N-n} \sum_{l=k}^n \binom{n}{l} (1 - p'_f)^l (p'_f)^{n-l} \end{cases} \quad (20)$$

where n represents the number of SUs who can conduct local decisions.

It is worth noting that high false alarm probability may make SU lose spectrum opportunities, and excessive missed detection probability will result in certain interference to the PU. Therefore, the global error probability can be represented by the probabilities of missed detection and false alarm, which can be referred to as constraints to derive the optimal voting threshold. Accordingly, we construct the optimization objective function, $U' = p(H_0)Q_f + p(H_1)(1 - Q_d)$, to minimize the global error probability of the cognitive radio network. The desired value of k can be described as

$$\begin{aligned} k_{opt} &= \arg \min \{ p(H_0)Q_f + p(H_1)(1 - Q_d) \} \\ s.t. & p(H_0) + p(H_1) = 1. \end{aligned} \quad (21)$$

Hence, the objective function U' can be expressed as

$$\begin{aligned} U' &= p(H_1) \sum_{n=0}^N \binom{N}{n} (1 - \Theta_1)^n \Theta_1^{N-n} \sum_{j=k}^n \binom{n}{j} (p'_m)^j (p'_d)^{n-j} + p(H_0) \\ &\quad \left[1 - \sum_{n=0}^N \binom{N}{n} (1 - \Theta_0)^n \Theta_0^{N-n} \sum_{j=k}^n \binom{n}{j} (1 - p'_f - \Theta_0)^j (p'_f)^{n-j} \right] \end{aligned} \quad (22)$$

Let $\frac{\partial U'}{\partial k} \Big|_{k_{opt}} = 0$, the objective function will be minimized and we have

$$\begin{aligned} p(H_0)(1 - \Theta_0)^n \Theta_0^{N-n} (1 - p'_f - \Theta_0)^{k_{opt}} (p'_f)^{n-k_{opt}} \\ = p(H_1)(1 - \Theta_1)^n \Theta_1^{N-n} (p'_m)^{k_{opt}} (p'_d)^{n-k_{opt}}. \end{aligned} \quad (23)$$

Since the value of k should be a positive integer, it can be computed as

$$k_{opt} = \left\lceil \frac{n \ln \frac{p'_d}{p'_f} \cdot \left(\frac{1-\Theta_1}{1-\Theta_0} \right) + (N - n) \ln \left(\frac{\Theta_1}{\Theta_0} \right) - \ln \frac{p(H_0)}{p(H_1)}}{\ln p'_d (1 - p'_f - \Theta_0) - \ln p'_f p'_m} \right\rceil. \quad (24)$$

Since $p'_d \gg p'_f$, $\frac{\partial^2 U'}{\partial k^2} > 0$. Therefore, the minimal global error probability can be obtained when k is equal to k_{opt} .

Credibility of energy statistic

For the energy statistic in no decision zone, it is not appropriate to conduct binary hypothesis test to make sensing decision. In order to improve the detection accuracy, the filtered samples inside of the range (λ_1, λ_2) can be exploited. Since it is impossible to give an accurate local decision by relying on those detection values, we consider sending them to the fusion center for further process. Soft fusion will be more reasonable choice, which enables the above fuzzy test statistics to participate in the final decision [38]. Therefore, the credibility degree can be defined to quantify the reliability of the test statistics lying between two thresholds. Specifically, the credibility degree should be discussed by the two hypothesis as follows.

Under hypothesis H_0 , we define the credibility degree of SU i as:

$$R_i(H_0) = \frac{M}{2} \delta_{i0}^2 - \sigma_{ui}^2 \mu_{i0}. \tag{25}$$

Taking the expressions of μ_{i0} and δ_{i0}^2 , it can be observed that the theoretical credibility is equal to 0. Considering that the uncertainty of the noise and the limited number of samples in the actual environment, $R_i(H_0)$ should be estimated within a permissible error range, i.e., $R_i(H_0) \in [-\xi, \xi]$. ξ represents a small constant, which can be defined according to relevant environmental factors.

Similarly, the credibility degree of SU i under hypothesis H_1 will be defined as

$$R_i(H_1) = \frac{M}{2} \delta_{i1}^2 - \sigma_{ui}^2 \mu_{i1} = P_i (P_i + \sigma_{ui}^2). \tag{26}$$

To distinguish the credibility degree in two cases, $R_i(H_1) \gg \xi$ should be guaranteed strictly.

Next, we can evaluate the reliability of the test statistics according to the credibility degree. The mean and the variance of the test statistics from SU i can be expressed as

$$\begin{cases} \hat{\mu}_{ij} = \frac{1}{M} \sum_{k=1}^M |x_i(k)|^2 \\ \hat{\delta}_{ij}^2 = \frac{1}{M} \sum_{k=1}^M [|x_i(k)|^2 - \hat{\mu}_{ij}]^2 \end{cases} \tag{27}$$

where $j = 0$ or 1 .

Therefore, for the SUs in the fuzzy region, there exist two kinds of scenarios:

- (1) If the detected values lie between the range of $(0, \lambda_{i,opt})$, it prefer to declare the absence of PU. In this case, the credibility degree will be calculated by formula (24). Only to satisfy with $R_i(H_0) \in [-\xi, \xi]$, it indicates that the test statistics is credible.

- (2) Otherwise, the result will be inclined to the existence of the PU as $E_i \in (\lambda_{i,opt}, +\infty)$. At this point, $R_i(H_1)$ is used to denote the reliability of the test statistics from SU i . If $R_i(H_1)$ is greater than the parameter ξ , the test statistics can be sent to FC for final fusion.

Fusion process

In our dual threshold energy detection, test statistic greater than upper threshold or less than lower threshold can obtain local decision. Because the reliability of the local test results of different SUs is different. Therefore, we can further improve the performance of cooperative spectrum detection by considering the reliability of each user’s local detection results. As for the detected values lying between two thresholds, we have not ignored them instead of extract useful samples for further fusion, so as to increase performance as well as reliability. To minimize the probabilities of false alarm and missed detection, the optimal fusion rule is presented as shown in Fig. 2.

The main steps are discussed as follows:

- (1) N SUs perform local spectrum sensing with the energy detector. Each cooperating SU will compared its test statistics with the threshold λ_1 and λ_2 , and then decide whether to make a local decision or send the sample values to FC. The local decision is made based on the energy test as follows:

$$S_i = \begin{cases} 0, & 0 \leq E_i < \lambda_1 \\ 1, & E_i > \lambda_2 \end{cases} \quad (28)$$

Those cognitive independent decision results of local energy detection will be sent to FC. And then, the FC employs the optimizing k-out-of-N rule to obtain a final decision.

- (2) If $\sum_{i=1}^n S_i \geq k_{opt}$, it means that the local decisions can be trusted and the existence of PU can be determined. The final decision can be obtained as:

$$FD = 1, \quad \text{if } \sum_{i=1}^n S_i \geq k_{opt} \quad (29)$$

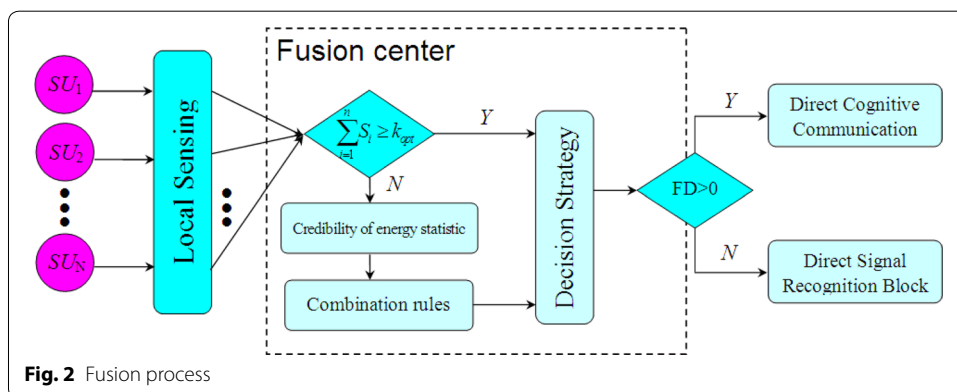

- (3) Otherwise, it demonstrates that the number of decision SUs is not enough, and comprehensive decision should be conducted. Further, for the test statistic in fuzzy zone, the credibility degree of corresponding SU will be evaluated. After choosing the reliable samples, FC employs the maximum ratio combining method for soft fusion, which can be expressed as:

$$T = \begin{cases} 1, & \sum_{i=1}^m w_i E_i > \lambda_{i,opt} \\ 0, & 0 \leq \sum_{i=1}^m w_i E_i \leq \lambda_{i,opt} \end{cases} \quad (30)$$

where m is the number of reliable test statistics. The weighted maximum ratio combining factor $w_i = \gamma_i / \sqrt{\sum_{j=1}^m \gamma_j}$, $\gamma_i = P_i / \sigma_{ui}^2$.

Then, the local decision results and the combinative fusion results obtained by FC will be combined for final decision as follows:

$$FD = \begin{cases} 1, & \text{if } \frac{m}{n+m} T + \frac{n}{n+m} \sum_{i=1}^n S_i \geq 1 \\ 0, & \text{otherwise} \end{cases} \quad (31)$$

Results and discussion

In this section, we evaluate the performance and present some experimental results to verify the feasibility of our proposed method. Due to the influence of noise uncertainty are significant, especially if the PU's SNR is below a certain level, we examine the sensing performance on the low SNR scenarios. The range of SNR is varied from -30 to 0 dB. In the experiments, the listening channels are assumed to be additive white Gaussian noise, and binary phase shift keying is applied for transmitting the hard decision result to FC. Moreover, the number of samples M is equal to 400. The probabilities of the idle and the busy state of the PU, $p(H_0) = p(H_1) = 0.5$. We have considered a fast-fading channel such that $h_i(k)$ changes after every 10 transmitted PU samples with $\delta_i = 1$. According to the model proposed in [41], noise uncertainty is generated. The results are obtained through monte-carlo simulations over 10,000 runs.

Figure 3 shows the result of the global error probability versus k with different values of noise power uncertainty. Based on the dual threshold is determined for the energy detection process, the minimum error probability can be obtained as choosing the optimum value of k . Because the optimal voting number varies with SNR and detection threshold, MAJORITY has more advantages than OR and AND criteria. From Fig. 3, we can observe that the smallest numbers of CRs to get the error rate target are 13, 14, and 15 with different noise uncertainty, respectively. This demonstrates that an optimal voting rule can minimize the error rate and the optimization of the dual threshold should take into account of the number of nodes in determining regions. Therefore, by using the total error rate criterion, it is possible to mitigate the influence of noise uncertainty and increase the spectrum sensing accuracy via joint optimization.

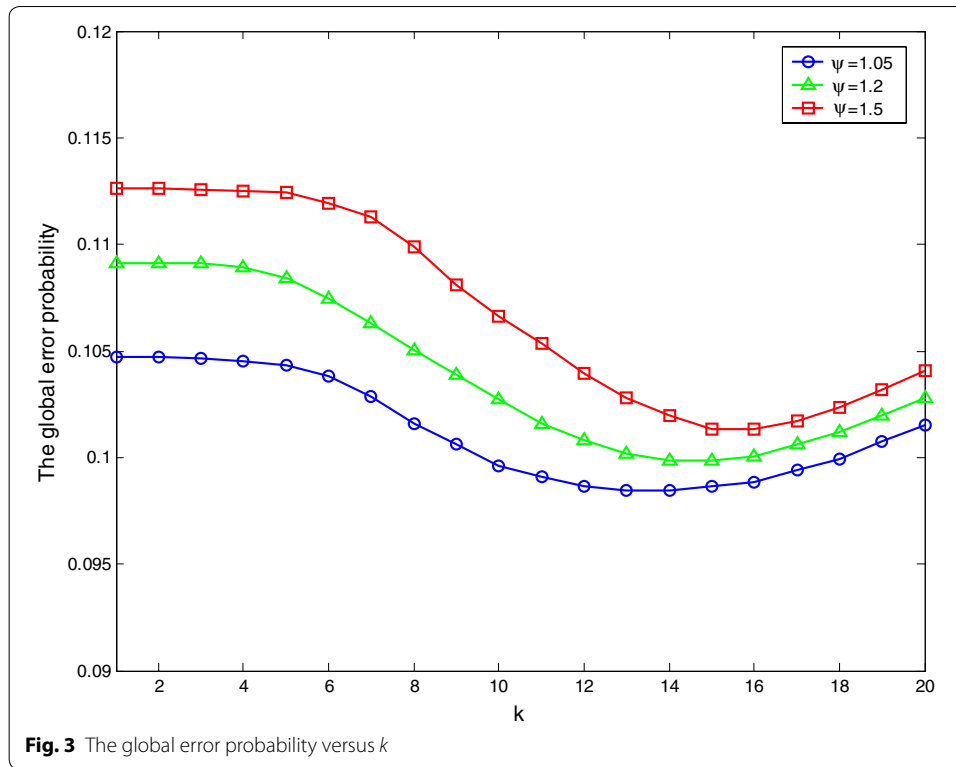
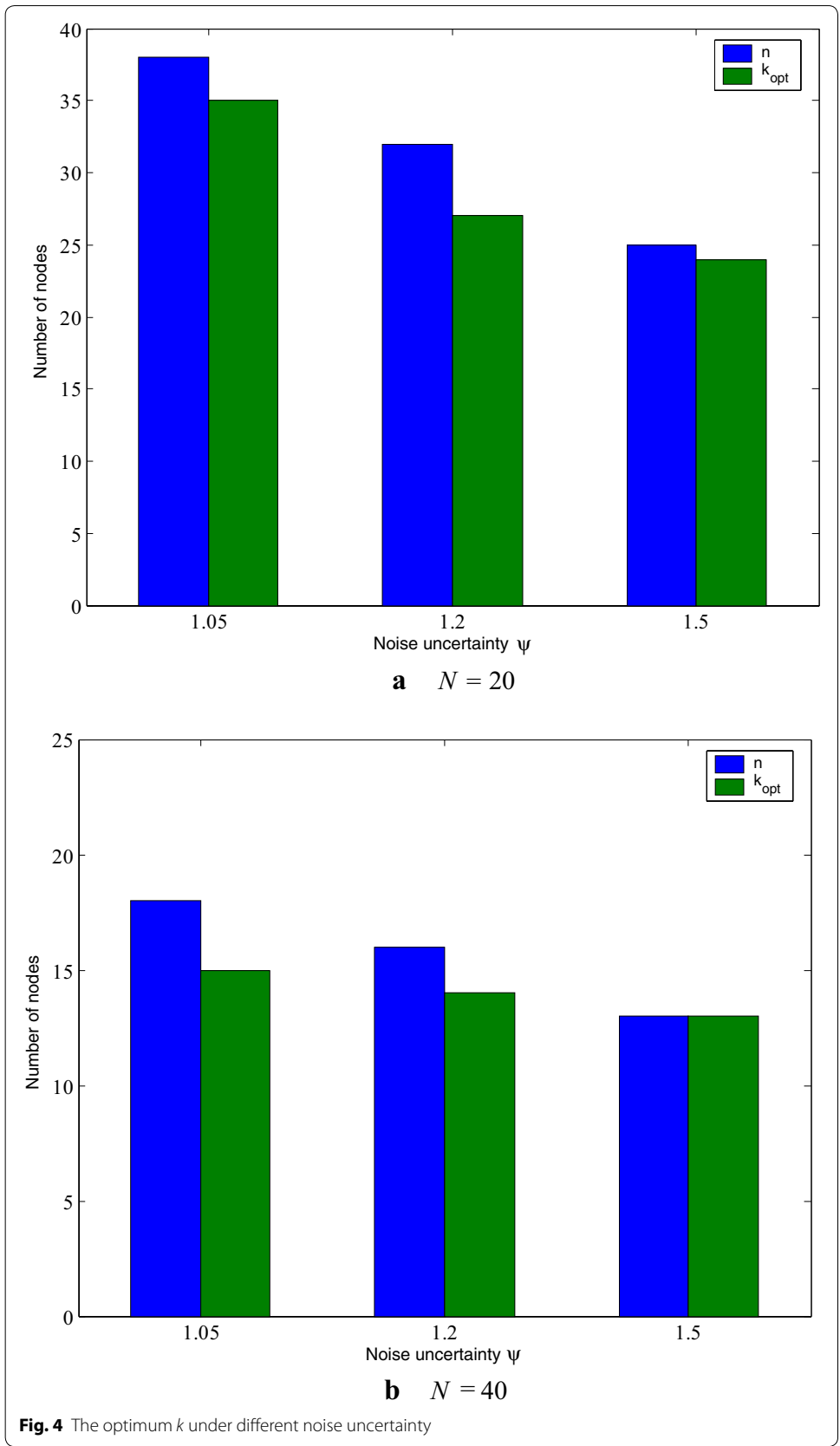
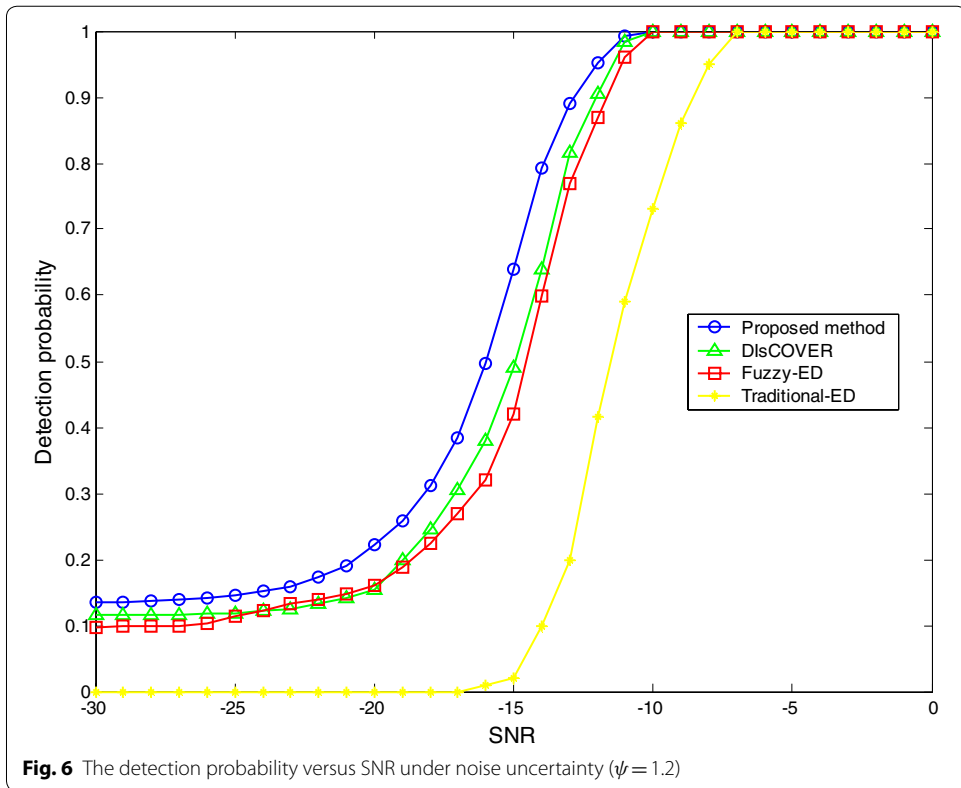
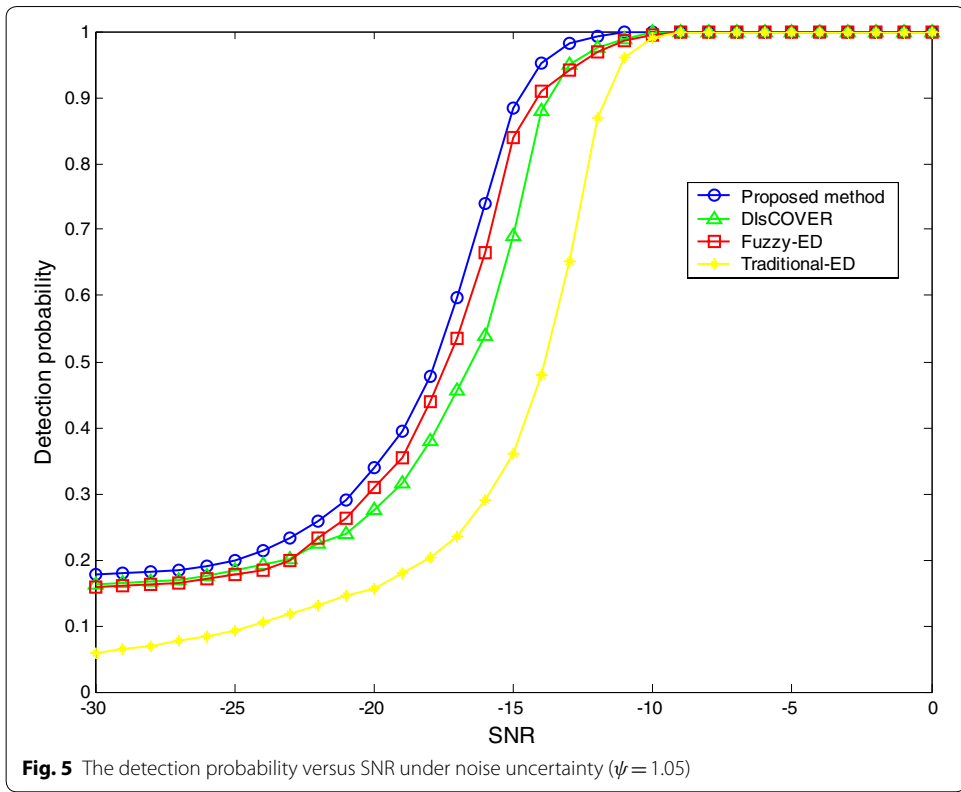

Figure 4 shows the relationship between the optimal k and the number of CRs in decision zones with different values of noise power uncertainty. From the experimental results, we can find that the values of n and the optimal k degrades with the increase of noise uncertainty. That is because the determination of threshold depends on the uncertainty of noise. When noise uncertainty is high, more nodes will be located in the fuzzy zone and no longer suitable for making local decision. Also, the result proves that CSS method uses $k = \lceil N/2 \rceil$ as MAJORITY fusion rule is not the optimal manner especially under noise power uncertainty. The above results also show that cooperative detection is an effective method to overcome the influence of noise uncertainty on detection performance.

The performance of the proposed method is compared with traditional-ED [3], Fuzzy-ED [39] and DIsCOVER [40]. The comparisons are performed for different SNRs by setting $p_f \leq 0.1$. Figures 5, 6 and 7 show the detection probability of above methods with different SNR and different values of noise power uncertainty. It can be observed that the spectrum-sensing performance is significantly improved by using the proposed dynamic dual threshold cooperative spectrum sensing approach compared with the traditional energy detection methods, particularly under very low SNR circumstances. Generally speaking, there is negative correlation between the performance of energy detection and the degree of noise uncertainty, especially when the CR system operates under low SNR scenarios.

As shown in the results, once the noise uncertainty is involved, the performance of the traditional approach can not be good enough for spectrum sensing. For instance,





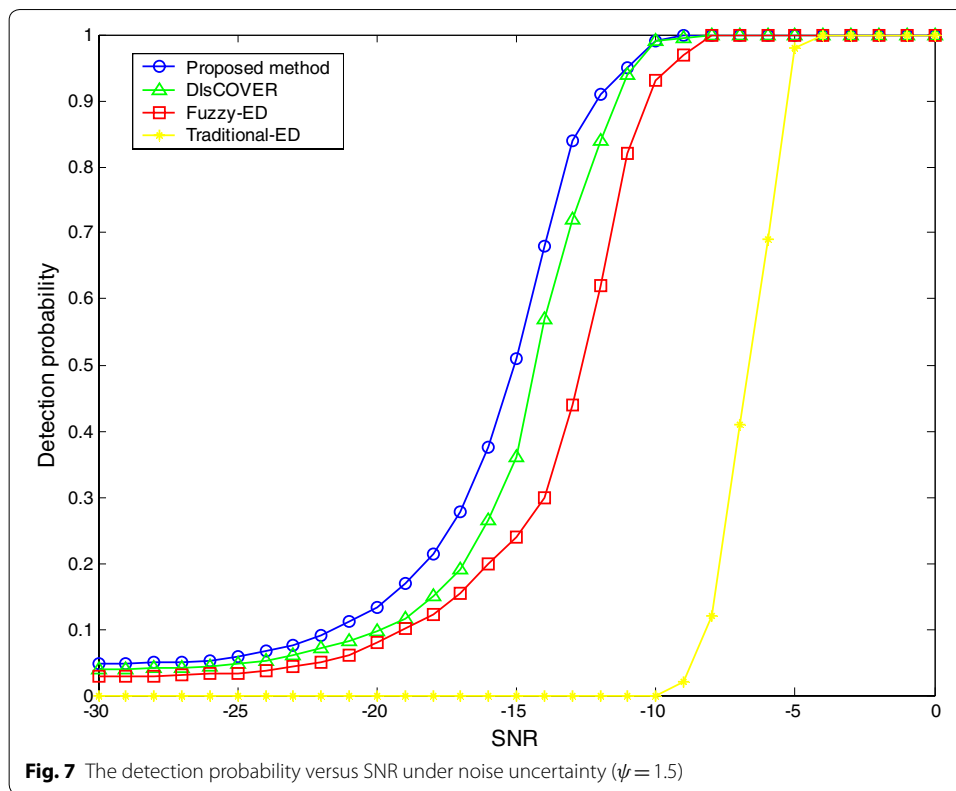

when the parameter of noise power uncertainty is set to 1.05, traditional-ED can maintain detection rate of 65.2% under -12 dB SNR. However, when the uncertainty factor is equal to 1.2, the detection rate under the same scenario is reduced to 41.5%. By investigating the effect of the noise power uncertainty on decision threshold, Fuzzy-ED and DISCOVER can demonstrate better performance in aspect of robust detection accuracy even under high noise uncertainty, which are shown in Fig. 6. As a comparison between those methods, it is clearly shown that our proposed scheme can achieve better performance than Fuzzy-ED by 14.3% and than DISCOVER by 32.7%, respectively, at low SNR even in the worst case. That is attributed to the fact that the threshold of energy detection in the proposed approach can be adjusted dynamically according to the detected SNR when interference and noise fluctuate. The final detection performance did not deteriorate obviously due to the change of interference and noise, and it demonstrates that the applied dynamic detection threshold can mitigate the influence of interference and noise uncertainty.

Figures 8, 9 and 10 show the detection probability versus probability of false alarm for those methods with noise uncertainty under -12 dB of SNR values respectively. Low false alarm probability enables SUs to access idle authorized bands effectively and greatly improve the utilization of spectrum resources. However, the detection probability has also been greatly reduced and it results in the chance of PUs being disturbed by SUs. The experimental results reflect the essential trade-off between the detection probability and the probability of false alarm. Under low noise uncertainty, such as $\psi = 1.2$ and 1.5, the detection performance in traditional-ED declines significantly. By comparison,

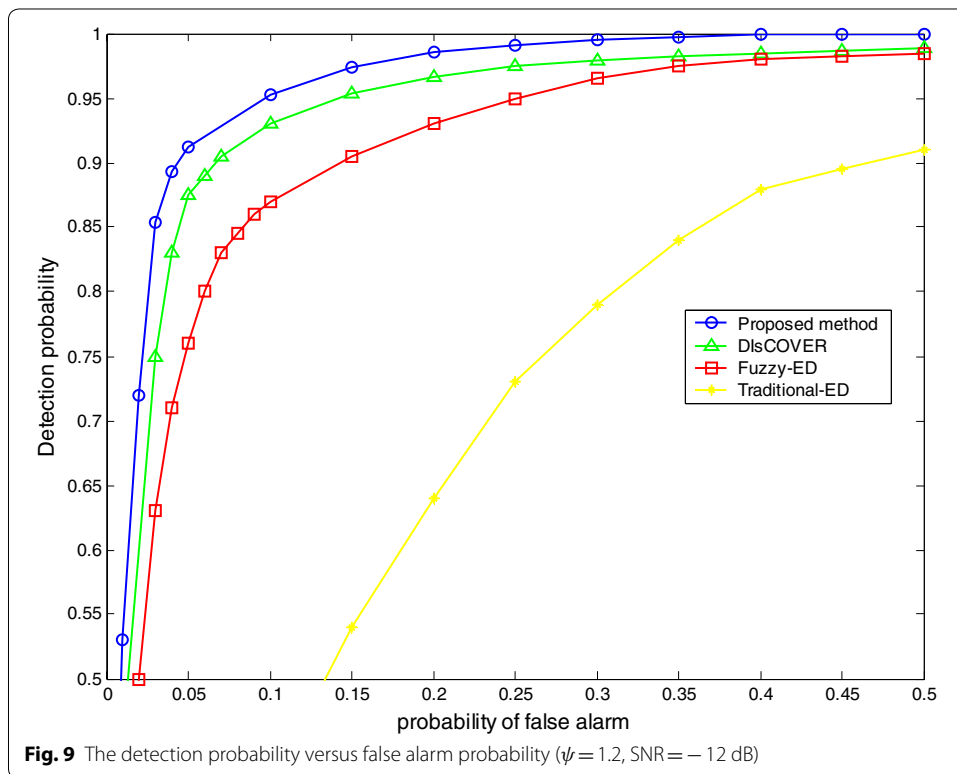
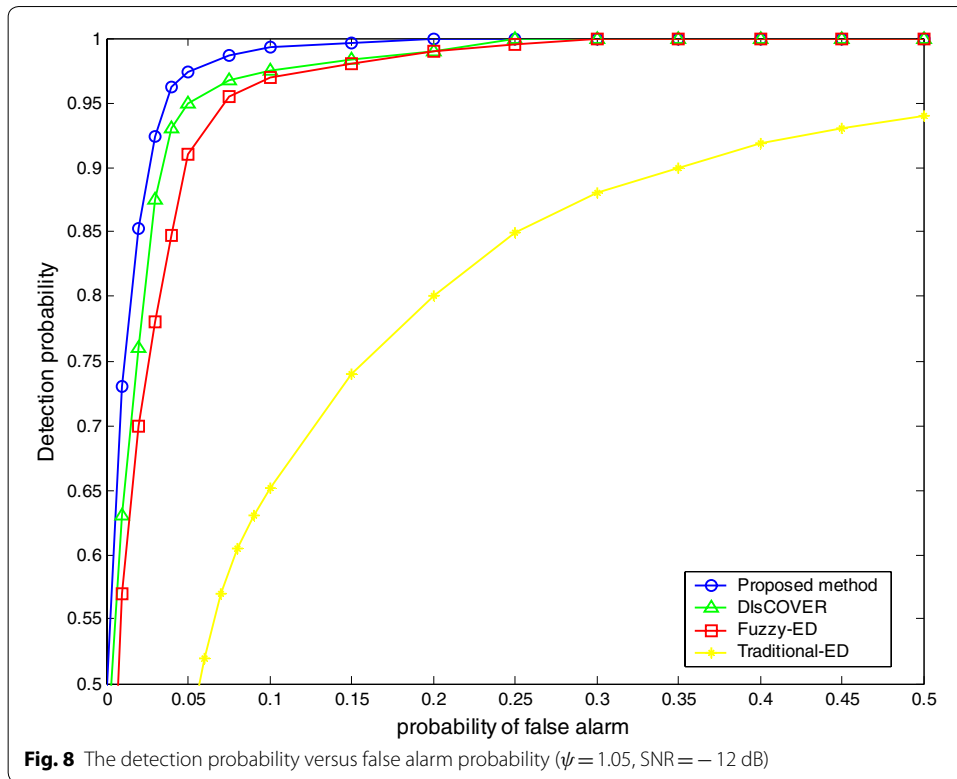

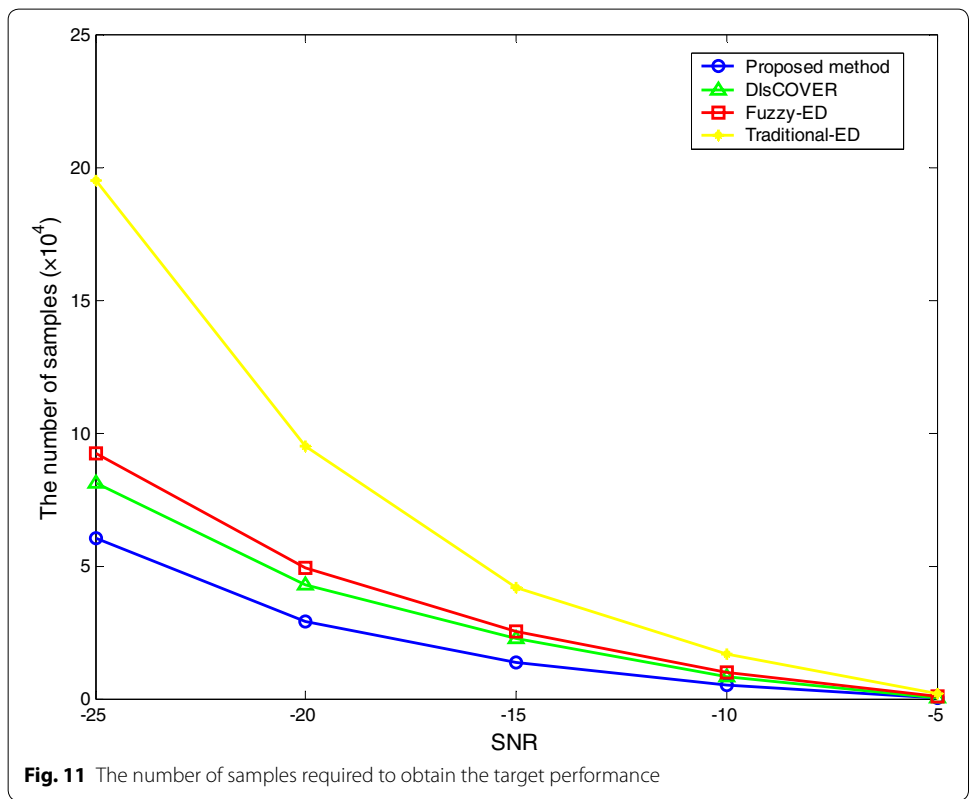
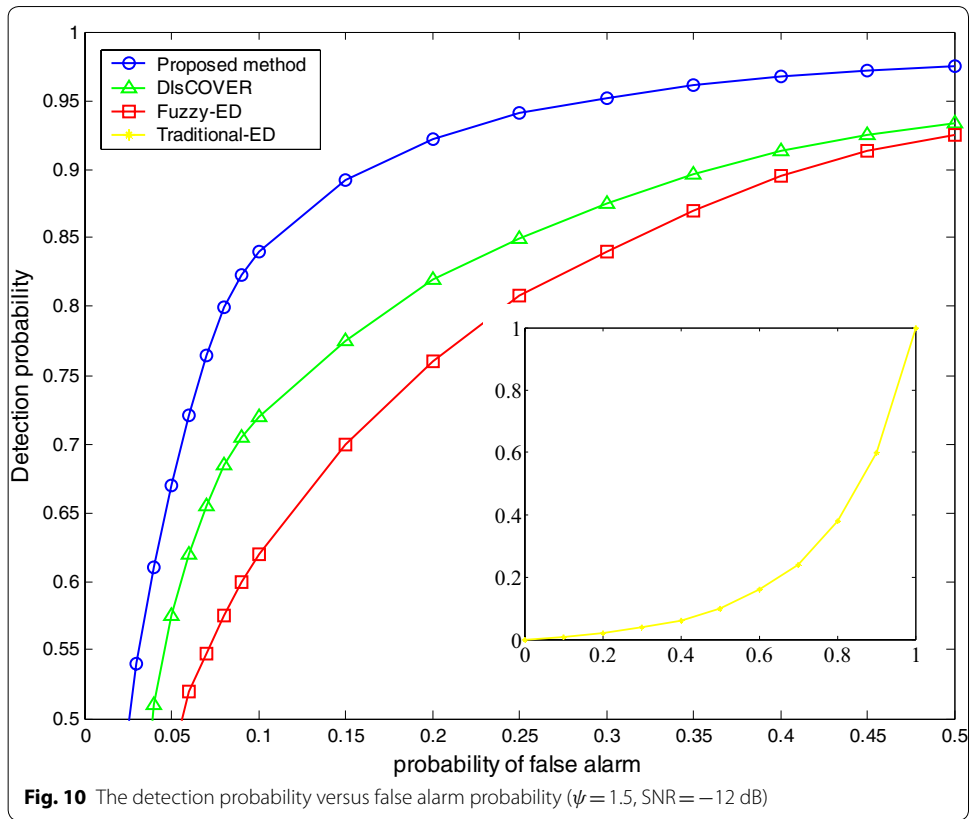

our proposed approach can exhibit robust detection performance even in the worst case, such as $\psi = 1.5$. It implies that the thresholds for energy detection in our proposed method can be determined dynamically according to noise uncertainty, and the optimal function is used to extract the appropriate trusted nodes to compensate for the deficiency of deterministic decision-making. As a result, it can achieve higher detection probability than other schemes under the same false alarm probability.

Besides, Fig. 11 shows the number of samples required by different schemes to obtain the same target performance of $p_d = 0.9$ and $p_f = 0.1$ under different SNR conditions. It is clearly shown that the number of samples required by the proposed scheme is much lower than that other methods to obtain the same sensing performance especially in low SNR conditions. At SNR = -25 dB, the proposed scheme succeeds to reduce the number of required samples compared to traditional-ED by 68.9%, 34.3% and 25.4% using Fuzzy-ED and DISCOVER, respectively to obtain the same target performance. The results can be considered as a significant complexity advantage of the proposed scheme because using a large number of samples are not preferred in the design of cooperative spectrum sensing because they will decrease the spectrum efficiency.

Conclusions

To solve the problem of low spectrum sensing accuracy under noise power uncertainty, an effective dynamic dual threshold cooperative spectrum sensing method was formulated, and an optimizing combinative fusion rule was designed by tracking optimal voting threshold and credibility of SU's energy statistic jointly. Simulation results show that the threshold of energy detection in the proposed approach can be adjusted dynamically according to the detected SNR when interference and noise fluctuate. And it can achieve higher detection probability than other schemes under the same false alarm probability. In future work, we will study the cooperative work of nodes in cognitive wireless sensor networks, and design more energy-saving spectrum sensing schemes on the premise of guaranteeing detection performance.

Acknowledgements

The authors would like to appreciate all anonymous reviewers for their insightful comments and constructive suggestions to polish this paper in high quality. This research was supported in part by the National Natural Science Foundation of China (Grant No. 61603420), Science and Technology Major Project of Hubei province, China (No. 2017ACA105) and Natural Science Foundation of Hubei province, China (Grant No. 2017CFC819).

Authors' contributions

WR and DL contributed in the innovation ideas and theoretical analysis. XN helped to perform the analysis with constructive discussions. SW and YL carry out experiments. All authors read and approved the final manuscript.

Ethics approval and consent to participate

Not applicable.

Competing interests

The authors declare that they have no competing interests.

Author details

¹ School of Computer Science, Wuhan University, Wuhan 430072, China. ² Hubei Co-Innovation Center of Information Technology Service for Elementary Education, Hubei University of Education, Wuhan 430205, China. ³ Department of Mathematics and Computer Science, Northeastern State University, Tahlequah, OK 74464, USA. ⁴ College of Computer Science, South-Central University for Nationalities, Wuhan 430074, China.

Appendix

Derivation of Q_f and Q_d in Eq. (17)

$$\begin{aligned}
 Q_f &= \Pr\{S = 1|H_0\} = 1 - \Pr\{S = 0|H_0\} \\
 &= 1 - \Pr\{S = 0, n \neq N|H_0\} - \Pr\{S = 0, n = N|H_0\} \\
 &= 1 - \sum_{n=0}^{N-1} \binom{N}{n} \prod_{i=1}^n \Pr\{E_i \leq \lambda_1 \cup E_i \geq \lambda_2|H_0\} \prod_{i=n+1}^N \Pr\{\lambda_1 \leq E_i \leq \lambda_2|H_0\} \\
 &\quad \sum_{l=k}^n \binom{n}{l} (1 - p'_f)^l (p'_f)^{n-l} - \prod_{i=1}^n \Pr\{E_i \leq \lambda_1 \cup E_i \geq \lambda_2|H_0\} \sum_{l=k}^N \binom{N}{l} (1 - p'_f)^l (p'_f)^{N-l} \\
 &= 1 - \sum_{n=0}^{N-1} \binom{N}{n} \prod_{i=1}^n (1 - \Theta_0) \prod_{i=n+1}^N \Theta_0 \sum_{l=k}^n C_n^l (1 - p'_f)^l (p'_f)^{n-l} - \prod_{i=1}^N (1 - \Theta_0) \sum_{l=k}^N \binom{N}{l} (1 - p'_f)^l (p'_f)^{N-l} \\
 &= 1 - \sum_{n=0}^N \binom{N}{n} (1 - \Theta_0)^n \Theta_0^{N-n} \sum_{l=k}^n \binom{n}{l} (1 - p'_f)^l (p'_f)^{n-l}
 \end{aligned}$$

$$\begin{aligned}
 Q_d &= 1 - \Pr\{S = 0|H_1\} \\
 &= 1 - \Pr\{S = 0, n \neq N|H_1\} - \Pr\{S = 0, n = N|H_1\} \\
 &= 1 - \sum_{n=0}^{N-1} \binom{N}{n} \prod_{i=1}^n \Pr\{E_i \leq \lambda_1 \cup E_i \geq \lambda_2|H_1\} \prod_{i=n+1}^N \Pr\{\lambda_1 \leq E_i \leq \lambda_2|H_1\} \\
 &\quad \sum_{l=k}^n \binom{n}{l} (p'_m)^l (1 - p'_m)^{n-l} - \prod_{i=1}^n \Pr\{E_i \leq \lambda_1 \cup E_i \geq \lambda_2|H_1\} \sum_{l=k}^N \binom{N}{l} (p'_m)^l (1 - p'_m)^{N-l} \\
 &= 1 - \sum_{n=0}^{N-1} \binom{N}{n} \prod_{i=1}^n (1 - \Theta_1) \prod_{i=n+1}^N \Theta_1 \sum_{l=k}^n \binom{n}{l} (p'_m)^l (1 - p'_m)^{n-l} - \prod_{i=1}^N (1 - \Theta_1) \sum_{l=k}^N \binom{N}{l} (p'_m)^l (1 - p'_m)^{N-l} \\
 &= 1 - \sum_{n=0}^N \binom{N}{n} (1 - \Theta_1)^n \Theta_1^{N-n} \sum_{l=k}^n \binom{n}{l} (p'_m)^l (1 - p'_m)^{n-l}
 \end{aligned}$$

Received: 18 December 2018 Accepted: 3 May 2019

Published online: 03 June 2019

References

1. Ejaz W, Ghalib AS, Najam H, Hyung SK (2015) Energy and throughput efficient cooperative spectrum sensing in cognitive radio sensor networks. *Trans Emerg Telecommun Technol* 26(7):1019–1030
2. Ahmadfard A, Jamshidi A, Keshavarz-Haddad A (2017) Probabilistic spectrum sensing data falsification attack in cognitive radio networks. *Signal Process* 137:1–9
3. Cichoń K, Kliks A, Bogucka H (2016) Energy-efficient cooperative spectrum sensing: a survey. *IEEE Commun Surv Tutor* 18(3):1861–1886
4. Ghaznavi M, Jamshidi A (2015) A reliable spectrum sensing method in the presence of malicious sensors in distributed cognitive radio network. *IEEE Sens J* 15(3):1810–1816
5. Ghaznavi M, Jamshidi A (2017) Defence against primary user emulation attack using statistical properties of the cognitive radio received power. *IET Commun* 11(9):1535–1542
6. Zhang D, Chen Z, Ren J, Zhang N, Awad M, Zhou H, Shen X (2017) Energy-harvesting-aided spectrum sensing and data transmission in heterogeneous cognitive radio sensor network. *IEEE Trans Vehicle Technol* 66(1):831–884
7. Maleki S, Leus G, Chatzinotas S, Ottersten B (2015) To AND or to OR: on energy-efficient distributed spectrum sensing with combined censoring and sleeping. *IEEE Trans Wireless Commun* 14(8):4508–4521
8. Gavrilovska L, Atanasovski V (2011) Spectrum sensing framework for cognitive radio networks. *Wireless Pers Commun* 59(3):447–469
9. Zhang W, Ranjan KM, Mallik KB (2009) Optimization of cooperative spectrum sensing with energy detection in cognitive radio networks. *IEEE Trans Wireless Commun* 8(12):5761–5766
10. López-Benítez M, Casadevall F (2012) Improved energy detection spectrum sensing for cognitive radio. *IET Commun* 6(8):785–796
11. Zi-yang L, Tao P, Hai-bo G (2012) Energy detection about broadband signal without priori information of interference system. *J Beij Univ Posts Telecommun* 35(5):31–35

12. Liu SQ, Hu BJ, Wang XY (2012) Hierarchical cooperative spectrum sensing based on double thresholds energy detection. *IEEE Commun Lett* 16(7):1096–1099
13. Umebayashi K, Hayashi K, Lehtomäki JJ (2017) Threshold setting for spectrum sensing based on statistical information. *IEEE Commun Lett* 21(7):1585–1588
14. Bagwari A, Tomar GS (2014) Cooperative spectrum sensing with multiple antennas using adaptive double-threshold based energy detector in cognitive radio networks. *J Instit Eng (India)* 95(2):107–112
15. Li H, Li J (2015) Wavelet transforms detection of spectrum sensing in the space network. In: *Proceeding of science and information conference*. IEEE, London, pp 978–984
16. Hojjati SH, Ebrahimzadeh A, Andargoli SMH, Najimi M (2016) Energy efficient cooperative spectrum sensing in wireless multi antenna sensor network. *Wireless Netw* 23(2):567–578
17. Atapattu S, Tellambura C, Jiang H (2011) Energy detection based cooperative spectrum sensing in cognitive radio networks. *IEEE Trans Wireless Commun* 10(4):1232–1241
18. Maleki S, Pandharipande A, Leus G (2011) Energy-efficient distributed spectrum sensing for cognitive sensor networks. *IEEE Sens J* 11(3):565–573
19. Singh A, Bhatnagar MR, Mallik RK (2012) Cooperative spectrum sensing in multiple antenna based cognitive radio network using an improved energy detector. *IEEE Commun Lett* 16(1):64–67
20. Sun H, Nallanathan A, Wang C (2013) Wideband spectrum sensing for cognitive radio networks: a survey. *IEEE Wireless Commun* 20(2):74–81
21. Tandra R, Sahai A (2008) SNR walls for signal detection. *IEEE J Select Topics Sig Process* 2(1):4–17
22. Deepak RJ, Dimitrie CP, Octavia AD (2010) Adaptive spectrum sensing with noise variance estimation for dynamic cognitive radio systems. In: *Proceeding of IEEE 44th annual conference on information sciences and systems*, pp 1–5
23. Mariani A, Giorgetti A, Chiani M (2011) Effects of noise power estimation on energy detection for cognitive radio applications. *IEEE Trans Commun* 59(12):3410–3420
24. Saber MJ, Sadough SMS (2015) Optimal soft combination for multiple antenna energy detection under primary user emulation attacks. *AEU Int J Elect Commun* 69(9):1181–1188
25. Jamshidi A (2009) Performance analysis of low average reporting bits cognitive radio schemes in bandwidth constraint control channels. *IET Commun* 3(9):1544–1556
26. Abbas T, Masoumeh N-K, Azizollah J Efficient cooperative spectrum sensing in cognitive radio. In: *Proceeding of the 18th annual IEEE international symposium on personal, indoor and mobile radio communications (PIMRC'07)*, pp 1–6
27. Ahuja B, Kaur G (2017) Design of an improved spectrum sensing technique using dynamic double thresholds for cognitive radio networks. *Wireless Pers Commun* 97(1):821–844
28. Peh ECY, Liang YC, Guan YL, Pei Y (2011) Energy efficient cooperative spectrum sensing in cognitive radio networks. In: *Proceeding IEEE global telecommunication conference (GLOBECOM)*, pp 1–5
29. Yucek T, Arslan H (2009) A survey of spectrum sensing algorithms for cognitive radio applications. *IEEE Commun Surv Tutor* 11(1):116–130
30. Sachin C, Jarmo L, Visa K, Vincent P (2013) BEP walls for cooperative sensing in cognitive radios using k-out-of-n fusion rules. *Sign Process* 93(7):1900–1908
31. Sun M, Zhao C, Yan S, Li B (2016) A novel spectrum sensing for cognitive radio networks with noise uncertainty. *IEEE Trans Veh Technol* 66(5):4424–4429
32. Lopez-benitez M, Casadevall F (2013) Signal uncertainty in spectrum sensing for cognitive radio. *IEEE Trans Commun* 64(4):1231–1241
33. Ghaznavi M, Jamshidi A (2013) Efficient method for reducing the average control bits in a distributed cooperative sensing in cognitive radio system. *IET Commun* 7(9):867–874
34. Zhang Z, Wen X, Haixia X, Yuan L (2018) Sensing nodes selective fusion scheme of spectrum sensing in spectrum-heterogeneous cognitive wireless sensor networks. *IEEE Sens J* 18(1):436–445
35. Ahhmadfard A, Jamshidi A, Biguesh M (2012) Capacity and power allocation for spectrum sharing in cognitive radio systems under unknown channel state information and imperfect spectrum sensing. *IET Commun* 6(15):2387–2394
36. Cacciapuoti AS, Akyildiz IF, Paura L (2012) Correlation-aware user selection for cooperative spectrum sensing in cognitive radio ad hoc networks. *IEEE J Sel Areas Commun* 30(2):297–306
37. Maleki S, Chepuri SP, Leus G (2013) Optimization of hard fusion based spectrum sensing for energy-constrained cognitive radio networks. *Physical Commun* 9:193–198
38. Yue W, Zheng B, Meng Q (2011) Robust cooperative spectrum sensing schemes for fading channels in cognitive radio networks. *China Sci F* 54(2):348–359
39. Mohammadia A, Tabana MR, Aboueia J, Torabib H (2013) Cooperative spectrum sensing against noise uncertainty using Neyman–Pearson lemma on fuzzy hypothesis test. *Appl Soft Comput* 13:3307–3313
40. Martínez DM, Andrade ÁG (2016) Adaptive energy detector for spectrum sensing in cognitive radio networks. *Comput Electr Eng* 52:226–239
41. Tandra R, Sahai A (2005) Fundamental limits on detection in low SNR under noise uncertainty. In: *Proceeding on international conference wireless network, communication mobile computer*, vol 1, pp 464–469

Publisher's Note

Springer Nature remains neutral with regard to jurisdictional claims in published maps and institutional affiliations.