

## Research Article

# Simulation and Emulation of MIMO Wireless Baseband Transceivers

**Pierre Greisen, Simon Haene (EURASIP Member), and Andreas Burg (EURASIP Member)**

*Integrated Systems Laboratory, ETH Zurich Gloriastrasse 35, 8092 Zurich, Switzerland*

Correspondence should be addressed to Pierre Greisen, greisen@iis.ee.ethz.ch

Received 10 June 2009; Revised 26 October 2009; Accepted 25 November 2009

Academic Editor: Arnd-Ragnar Rhiemeier

Copyright © 2010 Pierre Greisen et al. This is an open access article distributed under the Creative Commons Attribution License, which permits unrestricted use, distribution, and reproduction in any medium, provided the original work is properly cited.

The development of state-of-the-art wireless communication transceivers in semiconductor technology is a challenging process due to complexity and stringent requirements of modern communication standards such as IEEE 802.11n. This tutorial paper describes a complete design, verification, and performance characterization methodology that is tailored to the needs of the development of state-of-the-art wireless baseband transceivers for both research and industrial products. Compared to the methods widely used for the development of communication research testbeds, the described design flow focuses on the evolution of a given system specification to a final ASIC implementation through multiple design representations. The corresponding verification and characterization environment supports rapid floating-point and fixed-point performance characterization and ensures consistency across the entire design process and across all design representations. This framework has been successfully employed for the development and verification of an industrial-grade, fully standard compliant, 4-stream IEEE 802.11n MIMO-OFDM baseband transceiver.

## 1. Introduction

State-of-the-art wireless communication systems combine multiple-input multiple-output (MIMO) technology with different signaling schemes to increase throughput, link quality, stability, and range [1]. Unfortunately, the introduction of MIMO has also led to a significant increase in the hardware and system complexity of the baseband signal processing and has multiplied the number of modes of operation supported by state-of-the-art wireless communication standards. MIMO, in conjunction with orthogonal frequency division multiplexing (OFDM), will be employed in existing and upcoming standards such as IEEE 802.11n[2], IEEE 802.16e [3], and 3GPP LTE [4].

*1.1. From Research Testbeds to Industrial Grade Prototypes.* Since the inception of MIMO, considerable effort has been dedicated to the demonstration of the capabilities of the technology and to investigate the performance characteristics of corresponding transceivers in real-world scenarios. Toward this goal, various demonstrators and testbeds for MIMO communication have been developed. Figure 1(a) depicts

a common testbed architecture. The heart of the design, namely, the digital signal processing (DSP), is typically mapped onto FPGAs [5, 6], sometimes combined with dedicated application-specific integrated circuits (ASICs) for performance-critical system components [7], or onto DSP processors [8–11]. Data converters and a radio frequency (RF) frontend, equipped with several antennas, interface to the digital baseband transceiver. The wireless channel in MIMO testbeds is either a physical channel or a hardware radio frequency (RF) channel emulator. The signal processing is either performed in real-time or offline. In the real-time processing case, the samples are processed at the rate at which they enter the system and the signal processing meets potential latency requirements. In an off-line testbed, samples are recorded before and after over-the-air transmission and the DSP is performed off-line (e.g., in software) [7, 12–14]. Comprehensive overviews of MIMO testbeds are for example provided in [15–17].

Such demonstrators and testbeds have been proven to be instrumental research tools in the early phase of the development of new technologies [12]: during this early phase, many factors are still unknown or rely on heavily

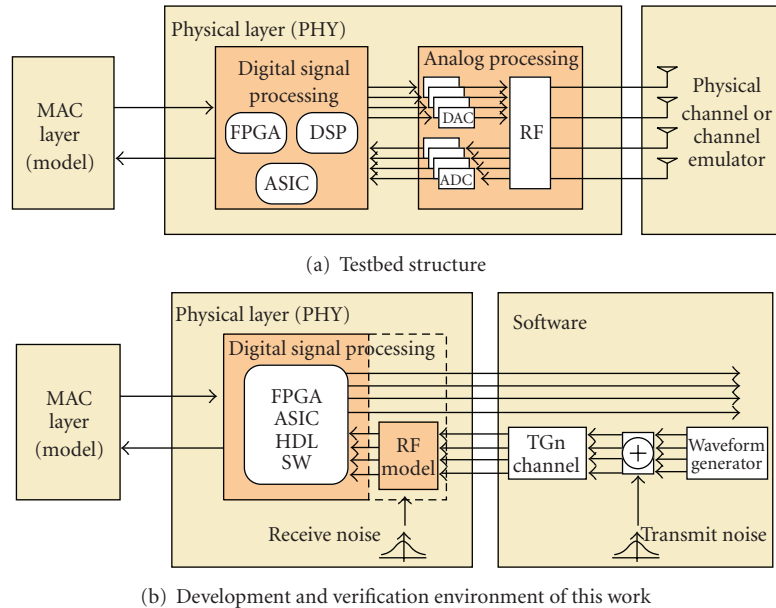

FIGURE 1: Typical testbed architecture 1(a), and this work's approach 1(b) (for a  $4 \times 4$  MIMO setup).

simplified and yet insufficiently verified theoretical models. For instance, in the MIMO case, the development and standardization of wideband MIMO channel models (e.g., [18]) has been an iterative process [19, 20]. The ability to avoid model uncertainties in the early days of a new technology is the strength and the justification for the development of research testbeds. Conversely, one of the drawbacks of such research testbeds is the lack of reproducibility. The nondeterministic behavior of the analog part of the design and the lack of control over the noise and the real-world wireless channel realization makes it impossible to fully reproduce or trigger specific test conditions or events. This lack of control makes a comparison with other testbeds or products virtually impossible and is a serious concern for the efficient verification and characterization of industrial products and for research areas that focus on the investigation of complexity-performance tradeoffs.

Thanks to the various testbed research contributions, the knowledge in MIMO communication has reached a level of maturity that allows proceeding to the development of fully integrated transceivers that are compliant to standards that were created for mass products. For the development and optimization of such products, the testbed approach shown in Figure 1(a) must be complemented with a verification environment that delivers fully deterministic and 100% reproducible results and supports a wide range of additional verification objectives that are mandatory for product development. Such an environment is illustrated in Figure 1(b). The basic idea is to separate the endeavor to understand and correctly model the physical environment (using testbeds) from the system development and characterization process.

In a nutshell, the objective of this paper is to describe the design and verification process of a standard compliant baseband transceiver ASIC. In contrast, our previous work in [5] and [7] describes a testbed setup which is designed to

evaluate the performance of packet-based wireless MIMO-OFDM transmission under real-world conditions. More generally, the major difference compared to other testbeds in the literature (i.e., [5–14, 19, 20]) is the fact that we rely intentionally on statistical channel models and on models for the analog/RF circuitry to allow for better reproducibility and interpretation and comparison of the test results. Also, the complexity of the setup is considerably reduced, since no coping with RF implementation intricacies is required. More on the negative side, the complexity of the software framework of our testbench is higher than for testbeds, but not substantially higher. For instance, the time to build the verification environment described in this paper was roughly a halfman-year, excluding the actual transceiver.

*1.2. Related Design and Verification Methodologies and Tools.* The DSP design flow employed in this work and reviewed in Section 2.1 involves different design representations, from MATLAB floating-point to register-transfer-level (RTL) hardware description language (HDL) (a similar design flow is described in [21]). To achieve the best possible hardware efficiency, the refinement from one representation to another was done manually. Nevertheless, some of the concepts in the present work rely on the paradigms from the five-ones approach described in [22]. However, an approach that adheres more strictly to the five-ones paradigm has received increasing levels of attention: high-level synthesis (HLS) (also referred to as behavioral synthesis). The HLS flow uses one high-level language model (e.g., in ANSI C or SystemC) and performs resource allocation, mapping, and scheduling either automatically or semiautomatically, often based on generic architecture templates. A commercial solution for HLS is for example Catapult C by Mentor [23]. Design of wireless communication systems using Catapult

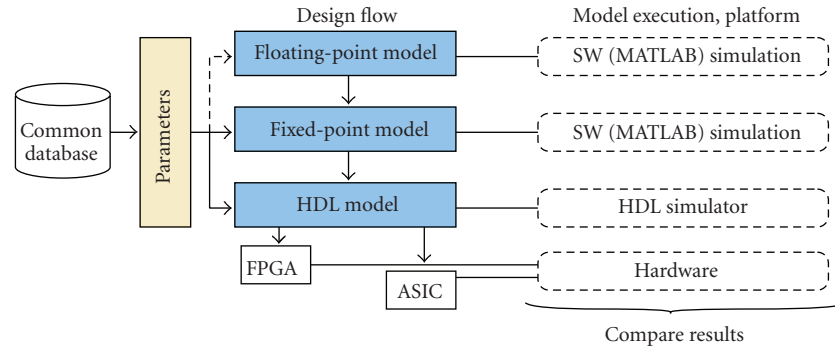

FIGURE 2: Design representations for the VLSI development process.

C is described in [24]. Beside the incontestable advantages described in [24], the automatic approach has two drawbacks: first, the quality for complex state-of-the-art designs still cannot be equivalent to the quality obtained by manual optimization by experienced VLSI designers. Second, the dependence on a specific commercial tool is often unwanted for industrial development.

An even higher level approach for describing and verifying complex wireless communication systems starts from virtual prototypes [25] built from hardware accelerators and DSPs. The physical layer under consideration in this paper is merely a single IP component in such a system which requires a verification strategy by itself. The electronic system level approach is currently not an option for the baseband processing itself since it is operating at the limit of modern process technologies.

**1.3. Contributions.** This tutorial paper describes the design flow and a verification and characterization framework for a standard-compliant industry-grade IEEE 802.11n transceiver. In particular, we highlight the role of the different design representations and the importance and structure of a corresponding verification methodology. Furthermore, a generic FPGA emulation platform is described, which provides performance characterization through hardware-accelerated Monte Carlo simulations.

**1.4. Outline.** The remainder of this paper is structured as follows. Section 2 reviews the VLSI design and verification process used in this work. The different design representations of the transceiver are introduced and motivated. Section 3 describes the verification methodology and the corresponding environment. The focus is on providing a framework that allows for consistent operation of the previously introduced design representations. Section 4 deals with the implementation of the verification framework. In particular, a generic FPGA emulation architecture is presented. Section 5 briefly reviews the IEEE 802.11n reference design and provides implementation figures of the transceiver in the framework and on the FPGA emulation platform.

## 2. Development Process

**2.1. Design Flow and Design Representations.** Our design flow for a DSP system [26] (Figure 2) starts with the design of a system-level architecture and the evaluation of suitable DSP algorithms. The outcome of this initial development phase is a behavioral floating-point model written in a high-level programming language (e.g., MATLAB or C/C++). The subsequent transition to a hardware implementation is a two-step process. The first step is the refinement of the floating-point model into a behavioral fixed-point model. The major effort in this step is the choice of suitable word widths for all arithmetic operations in the DSP data path. The second step is the translation of the behavioral fixed-point model into a corresponding RTL architecture and the description of that architecture in an HDL such as VHDL or Verilog. Automatic synthesis and place & route tools then map this code to an FPGA or to an ASIC.

The most crucial step in the above described design flow is the floating-to-fixed point conversion, since it has a significant impact on the final performance of the ASIC compared to the theoretical limit. There are several approaches to tackle the fixed-point conversion challenge. One can roughly separate the methodologies into simulation-based approaches and analytical approaches (and a combination of both) [27]. For instance, in [28] the floating-point model is manually converted into a hybrid code model by defining fixed-point word widths at some “important” locations; the remaining floating-point values are then interpolated by analytical means. A similar approach is described in [27], but optimized for digital signal processor architectures. The quality of such procedures can be increased by taking into account the target system performance (e.g., the bit-error rate specification) and by iterating until the target performance is achieved [29]. The approach in this work is similar to [28], but less automated. In essence, word widths at important block interfaces are defined and all other values are deduced. However, we infer the remaining values manually, mainly by MATLAB Monte Carlo simulations or theoretical considerations on the subblock level. Fine-tuning at the system level is performed through Monte Carlo simulations based on the HDL implementation.

TABLE 1: Characteristics of different transceiver simulation models.

Model/Platform	Characteristics	Scope (used for...)
Floating-point/SW Simulation	Fast (runtime)	Algorithm development
	Far from hardware (HW) (data and control path)	Reference for other models
Fixed-point/SW Simulation	Slow (runtime)	Golden model for HDL
	Same data path as HW	Debug data path
	Different control path	
	Not cycle-true	
HDL/Simulator	Slow (runtime)	Debug control path
	Data and control path as in final ASIC	Cycle-accurate: determine latencies
HDL/FPGA	Fast (runtime)	Performance, fixed-point characterization
	Accelerated HDL simulation	Large coverage of functional runs Regression runs

2.2. *Automated File Generation.* Maintaining different design representations is error-prone [22] when different teams work in parallel on different representations of the same block. To overcome this draw-back, the same person is typically in charge of maintaining all representations of a single block. On the system-level, automatic conversion scripts are employed to maintain important parameters such as data-types, word-lengths, and register address maps in a single database (Figure 2). This measure together with regular simulation runs helps to ensure consistency across different design representations.

2.3. *Verification Tasks and Objectives.* The development process described above raises several verification objectives.

(1) *Performance Characterization:* For large systems, such as MIMO wireless transceivers, the performance is not known a priori and can usually not be obtained analytically. Hence, only statistical evaluation methods can be employed and results must be reviewed in comparison to the performance of other candidate algorithms and to solutions known to be optimal. In general, the corresponding characterization process requires a large number of Monte Carlo simulations which are only feasible when simulation runtimes are sufficiently short.

(2) *Fixed-Point Accuracy Analysis:* Similar to the first objective, performance characterization of fixed-point implementations is realized through Monte Carlo simulations. The results of these simulations are compared to the results of corresponding floating-point simulations to determine the associated implementation loss. Fixed-point design parameters are adjusted according to that loss and simulations are repeated.

(3) *Functional Verification:* As opposed to the first two objectives, functional verification is concerned with the question whether or not an implementation behaves according to the behavioral specifications of the system. The corresponding evaluation is usually carried out based on a number of predefined testcases for which the expected response of the system is either known a priori or is obtained from a known-good reference model. The latter

is often another, more abstract and already sufficiently verified, design representation against which the current design representation is compared. A typical example is the comparison of the HDL model against a software fixed-point model or the comparison against the behavior of the floating-point model or against known expected results under ideal conditions. To achieve sufficient test coverage, functional verification is usually performed with a large number of meaningful but randomly chosen testcases in combination with a set of dedicated and carefully selected testcases [26].

(4) *Regression Testing:* For larger projects, regular regression testing must be performed to maintain the integrity of the design and coherence of the different design representations over the entire duration of the project.

Table 1 relates the above described objectives to the different design representations and to the corresponding simulation platforms.

### 3. Verification Environment

3.1. *Verification Flow.* To meet the different verification objectives, we propose an automated verification flow shown in Figure 3 that is tailored to ensure coherence between the different design representations. The basic concept behind this flow is to start with a compact *testcase* definition that is subsequently expanded into *stimuli* that are compatible with all design representations. For each design representation, a *testbench* reads these stimuli and records the responses. The response files are consolidated and forwarded to the final analysis. The different tasks are described in the following.

(1) *Testcase Definition:* The starting point for all verification tasks is the creation of a standardized testcase descriptor which defines the operations to be carried out on the transceiver. This description is completely model independent, so that any testcase can be executed on any platform and on all design representations. A simple testcase can for example stimulate the receiver to process a single incoming data packet, while more sophisticated testcases can describe elaborated sequences of interleaved packet transmissions

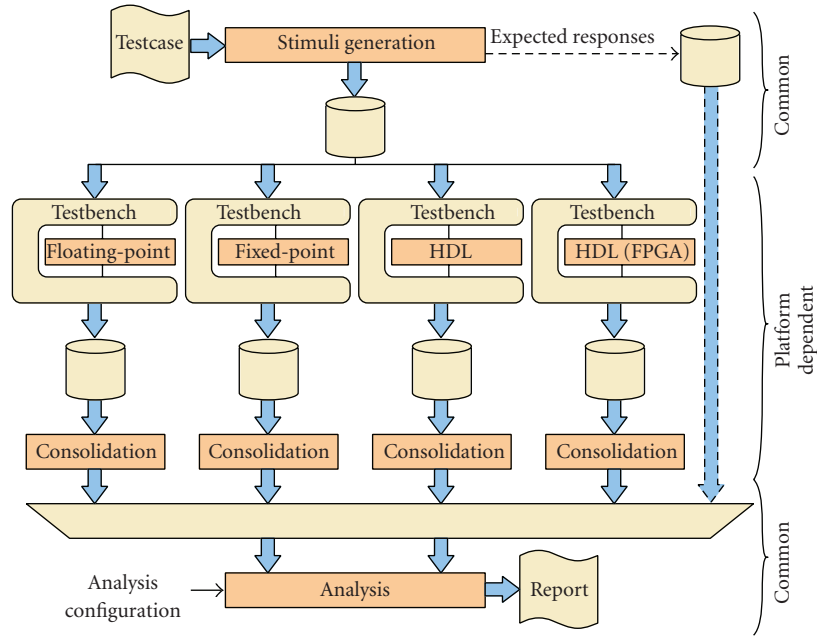

FIGURE 3: Top-Level Verification Flow.

and receptions. Under all circumstances, testcases define *all* parameters that are necessary for a simulation. These parameters include, among others, the random seeds for the generation of the channel realization through which a packet is transmitted, the specific noise realization, and the transmitted payload data. A key benefit of a complete descriptor is that stimuli generation is fully deterministic and reproducible, which is a prerequisite to ensure consistent and reproducible simulation results and is necessary for debug and regression testing.

In testcases, parameters are defined on a functional level that is independent of a particular implementation of the transceiver. Thus, if a specific feature of the transceiver shall be configured, only a functional abstraction of this setting is provided in the testcase. This is opposed to directly providing values for hardware registers, which need to be programmed in the HDL model but might not exist in other models or may change as the design evolves. The advantage of this abstraction is twofold: testcases are completely model independent and design changes do not affect existing testcases, reducing the effort for testcase maintenance which is particularly important for regression testing.

A typical testcase for performance characterization contains a large set of very similar simulation runs, which differ only in channel realization, noise realization, or received signal strength. To avoid having a different testcase for each of these very similar simulation runs, testcases can contain multiple simulation runs. These runs differ only by few parameters. The missing notion of relative timing among simulation runs calls for an even finer grained structure: each run is again sequenced into phases which can be timed relative to each other. This is required for functional verification of sequences of several transmit and/or receive simulations.

```

1 setup testcase data structure
2 foreach simulation run do
3   foreach sub-simulation run do
4     sanity check
5     if Configuration then
6       configuration parameters: functional to
7         operational translation
8     if Tx simulation then
9       generate transmit waveform
10    if Rx simulation then
11      generate receive waveform
12  sequence sub-simulation runs: concatenate
13  and synchronize
14  write concatenated sub-simulation runs to file

```

ALGORITHM 1: Stimuli Generation Flow.

(2) *Stimuli Generation*: Stimuli generation reads the compact, human-readable testcase definition and expands the testcase into still model-independent stimuli files. To be independent of the details of the implementation, stimuli are described at transaction level. Typical transactions are transceiver configuration, packet transmission, or packet reception. For each such operation, stimuli files provide the information required to operate the design under verification (DUV). The stimuli generation for the testcase structure described in the previous subsection is summarized by the pseudocode snippet in Algorithm 1.

(3) *Testbench Operation*: In order to apply the stimuli to the different design representations, an environment must



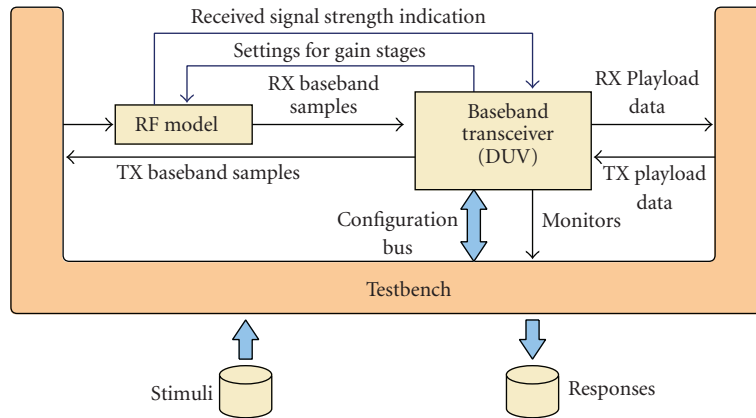

FIGURE 4: Testbench model.

be created that allows stimulating the inputs of the DUV and to record the responses at its outputs. Besides the DUV itself, the environment must also contain all those components that interact with the DUV and must supply signals that are specific to a particular design representation (e.g., clock and reset for an RTL model). The corresponding functionality is provided by a *testbench*. Ideally, the same testbench would enable the instantiation of all design representations to ensure consistency throughout the entire design process. Unfortunately, this method also requires the use of a single design-language for all design representations. Such a single-language approach has the advantage of allowing for a continuous step-by-step refinement from the original behavioral floating-point model to the final RTL implementation [22]. However, no single language is equally well suited for all design representations. For example, a hardware description language is clearly ill-suited for algorithm development, while a high-level language cannot provide the detailed representation of a parallel architecture that is required to achieve a hardware efficient silicon implementation. Hence, we shall follow an approach that uses multiple design languages as described in Section 2.1. For this approach, consistency of simulations across all design representations is of utmost importance. To achieve this objective, individual, compatible testbenches must be provided as illustrated in Figure 3. By operating different testbenches from the same stimuli files, different models can be compared against each other while ensuring that the same initial conditions apply. This cross verification of design representations is indispensable for the efficient evolution of a design and to ease debugging of more complicated RTL design representations by comparing them against corresponding behavioral golden models [26].

(4) *Consolidation*: The consolidation step translates the response files, which may differ in their format depending on the testbench that collected them, into a unified database appropriate for the subsequent analysis. No intelligence or interpretation of the data is provided in this step to ensure robustness against responses from buggy models.

(5) *Analysis*: The analysis task compares the consolidated simulation result against system specifications or against a reference. Such a reference can be obtained from another simulation run, that is, from the consolidated output of another design representation, for example, for comparing fixed-point against HDL simulations. Alternatively, the reference can consist of expected responses, which are obtained during stimuli generation. For a packet reception simulation for example, expected received data bytes can be compared to the transmitted payload, which is defined in the testcase, and the modulation and coding scheme detected by the receiver can be compared to the one specified in the testcase. The analysis operation itself is defined in a custom way: a database of analysis plug-ins is available, which can be instantiated according to the purpose of the testcase and the verification objective (e.g., calculate and display packet-error rates).

### 3.2. Testbench Interfaces for an IEEE 802.11n Transceiver.

Figure 4 shows a top-level testbench for the MIMO-OFDM baseband transceiver under consideration in Section 5. The depicted model is applicable to all design representations of the transceiver that emerge during the entire design and verification process (fixed-point, floating-point, or RTL simulation, and FPGA emulation). The testbench instantiates the DUV and a model for the analog RF circuitry as part of the simulation setup. This model is required since the RF and the digital transceiver form a closed-loop in which the baseband samples at the receiver input are influenced by the settings of the analog gain stages, which are controlled by the digital transceiver itself. The model of the RF circuitry is based on an industrial 802.11a RF integrated circuit. It features two gain stages and outputs complex baseband signals. The noise-figure is roughly 4–5 dB, but depends on the gain settings. The model is less accurate than the analog-HDL description employed for example in [30], but sufficient to model the key characteristics of the RF. The testbenches provide the following interfaces to the transceiver model.

*Configuration and control*, enabling the configuration of the transceiver and the management of data transmission

and reception. Typically, modulation and coding schemes are configurable and need to be controlled by the entity in charge of operating the baseband transceiver. For an RTL model for example, this corresponds to writing (and possibly reading) configuration registers.

*Analog frontend control interface*, enabling the interaction of the baseband receiver with the analog RF frontend model. Typically, the baseband processor is in charge of controlling variable gain stages in the RF circuitry and, in turn, receives information on the incoming signal strength from the analog frontend.

*Data interfaces*, for both transmitter and receiver. In transmit mode, payload data is accepted and baseband samples are output to the RF. In receive mode, baseband samples are accepted from the RF, and decoded payload data is output to the system components in charge of handling the higher layer protocols.

*Monitors*, that enable the observation of internal nodes of the baseband transceiver for the extraction of valuable debug information. While for software models the concept of monitors is quite straightforward, the observation of internal nodes is more involved for hardware design representations which require dedicated infrastructure to provide access to these nodes (see Section 4.3).

## 4. Implementation Aspects

In the previous section, the general verification flow was introduced. In this section, the implementation of this flow is described. The focus is on the use of an FPGA emulation platform for accelerated RTL simulations for functional verification and for fixed-point performance evaluation.

*4.1. Framework and Simulations.* The framework of the verification flow shown in Figure 3 is implemented in MATLAB. The interfaces to the simulation tasks are stimuli files stored to disc during stimuli generation. The interfaces to the consolidation steps are the response files written to disc during simulation.

The *floating-point* and *fixed-point models* of the DUV are written in MATLAB and hence can be executed directly from within the verification framework. The *HDL model*, instead, is written in synthesizable VHDL. Although started from within the framework, the HDL simulation is outsourced to an HDL simulator (Modelsim by Mentor, in our case). The interaction with this HDL simulator simply consists of passing the location of the stimuli files as parameters. In the same way, the HDL testbench is instructed where to dump the response files, so that the MATLAB framework knows which responses to process once the HDL simulation terminates.

*FPGA emulation* is supported by means of a hardware driver and dedicated low-layer functions (implemented in a foreign language interface provided by MATLAB, called *mex functions*) that allow stimuli and configuration data to be sent

to the FPGA and responses to be collected from the hardware through a PCIe bus. The next section discusses the FPGA testbench in more detail.

*4.2. FPGA Emulation Platform.* The main motivation for an FPGA emulation platform is the slow simulation speed of the fixed-point model and of the HDL design representation running on the HDL simulator platform. This slow simulation speed renders large amounts of bit-accurate simulations impractical. The emulation on FPGAs is a relatively low-cost alternative to dedicated hardware accelerators. FPGA emulation enables

- (i) Monte Carlo simulations for performance characterization (e.g., for the extraction of bit-error rates or packet-error rates),
- (ii) extensive functional verification runs with a large number of dedicated and random tests, to achieve high test coverage, and
- (iii) regression testing by checking whether new features or bug-fixes affect test results and to ensure coherence between the RTL code and other design representations.

An overview of the proposed FPGA testbench, comprising the FPGA infrastructure and the software, is provided in Figure 5. The depicted setup essentially corresponds to the testbench in Figure 4, implemented on an FPGA platform and on a host PC.

A bus bridge translates the PCIe protocol into the specific protocol supported by the configuration interface of the DUV. The other stimuli are sent from the host PC over the PCIe bus to dedicated *stimuli port adapters* which apply the data to the input ports of the DUV. Responses from the DUV are collected by *response port adapters* and are forwarded to the host PC. The number of port adapters is determined by the number of interfaces of the DUV and can be configured at synthesis time. A user-defined portion of the memory space, accessible from the host PC, is assigned to each port adapter. Port adapters are essentially FIFOs with configurable word widths designed to exhibit a handshake data interface for the application of stimuli and for the collection of responses. Type conversion functions translate the bit-vector outputs of the port adapters into arbitrary HDL data types used for the I/O ports of the DUV when applying stimuli, and vice versa when collecting responses. The conversion requires no hardware overhead.

The FIFOs in the port adapters are composed of three sub-FIFOs as shown in Figure 6. In stimuli port adapters, the first FIFO is built from on-FPGA SRAM macros. It accepts stimuli data from the PCIe controller and forwards this data to the second FIFO which is implemented on an external SDRAM module allowing for larger storage capacities. From the SDRAM FIFO, data is forwarded to the third FIFO, which is again realized on the FPGA. This third FIFO eventually pushes the stimuli into the DUV. For the response port adapters, a similar concept is implemented with the three FIFOs shuffling data in the opposite direction (from the DUV to the PCIe). In the proposed implementation,

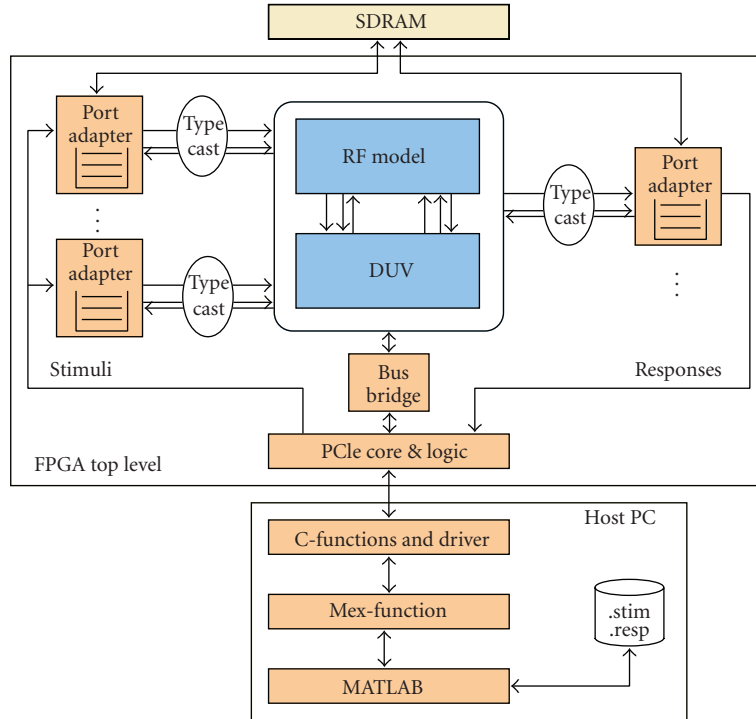

FIGURE 5: FPGA emulation testbench. The number of port adapters depends on the number of interfaces of the DUV.

multiple port adapters share a single PCIe connection and a single SDRAM module for the realization of their external FIFOs. To avoid bandwidth bottlenecks at these interfaces, the corresponding interface clocks must be kept as high as possible, while the clock of the DUV must be adjustable to facilitate the mapping and timing closure of the ASIC design on the FPGA. (Note that in most cases the DUV targets an ASIC process so that its architecture is ill-suited to achieve real-time operation on an FPGA. Hence, FPGA emulation typically runs at a fraction of the ASICs target clock frequency).

One drawback of the FPGA emulation is the long implementation time for large designs. To alleviate this issue and to make the system scalable to designs with higher complexity (e.g., using better receivers), the DUV can be partitioned over multiple FPGAs. The handshake interfaces between the blocks allow for putting an entire block on a second FPGA while routing the corresponding interfaces via FPGA interconnections. In this way, a block which is currently under construction can be implemented independently of the rest of the design (provided that the interfaces do not change). An automatic partitioning flow can also be set up using Certify [31], for instance.

**4.3. Monitoring of Internal Nodes.** The monitoring of internal nodes of the design for debugging and analysis is an important requirement. During MATLAB or HDL simulation, instantiated monitors can simply dump data according to a configuration file that selectively enables or disables monitors. However, for FPGA emulation or even for the final ASIC, providing sufficient visibility into the design is

a major challenge. In order to solve this problem, the DUV is equipped with a debug output port, whose bit-width can be configured at synthesis time. Internal nodes connected to monitors can be multiplexed to this port. Which node is observed can be configured using the configuration interface of the transceiver. If a particular node to be observed is wider than the debug port, several addresses are assigned to this node. Each address corresponds to a bit-slice of the node. In this case, multiple simulations must be carried out to reconstruct the complete signal, collecting a different bit-slice during each simulation. The data from the monitors is collected and consolidated together with other responses.

## 5. Application to IEEE 802.11n

In this case-study, the design under verification is a full IEEE 802.11n standard compliant MIMO-OFDM baseband transceiver. The digital signal processing part has been fabricated in 130 nm technology and is described in [32]. The main characteristics of the 802.11n transceiver are summarized in Table 2. A top level block diagram of the transceiver is provided in Figure 7. The transmit chain consists of three main blocks: the input data is the payload in octets, the output data is the baseband samples to be transmitted. The channel coding block contains a rate 1/2 convolutional encoder followed by a puncturer to obtain different coding rates (2/3, 3/4, and 5/6) and a bit-interleaver. The space time processing block first maps bits to complex valued constellation points (BPSK, QPSK, 16-QAM, or 64-QAM), then inserts zero and pilot tones for OFDM modulation. The output is then OFDM modulated using an inverse fast



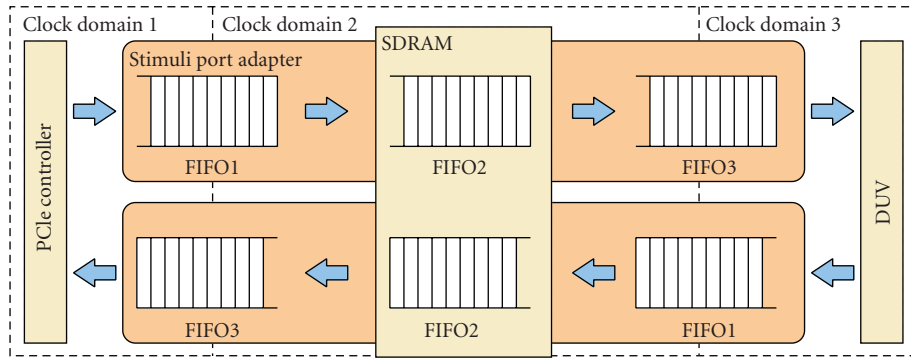

FIGURE 6: Structure of port adapters.

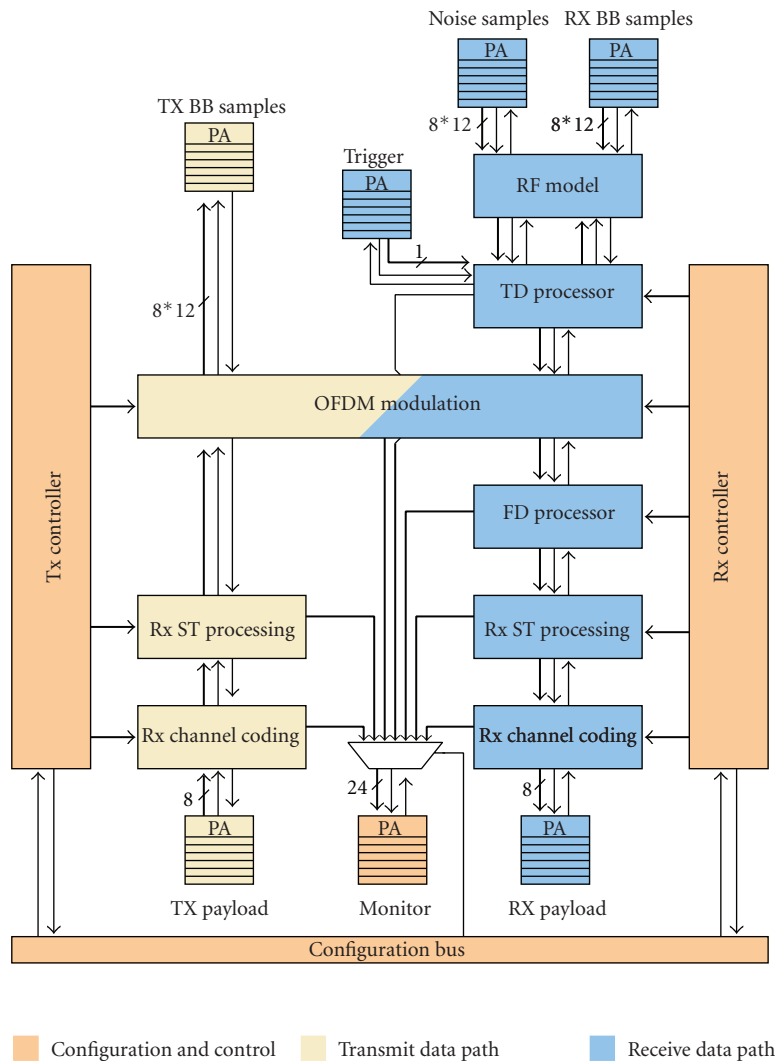

FIGURE 7: MIMO-OFDM Transceiver Overview.

Fourier transform (IFFT) shared with the receive chain. Prior to demodulation, the receiver needs to process the received signals in the time domain: frame start detection, frequency offset estimation, and digital gain control are the main tasks. After the FFT, the *Rx ST processing* block demaps the received

signals. The output is then deinterleaved, depunctured, and decoded using a Viterbi decoder.

The different coding rates, modulation schemes, and number of spatial streams are described by modulation and coding schemes (MCS) and are defined in the IEEE 802.11n

TABLE 2: Key figures of the 802.11n design [32] on different platforms.

	130 nm ASIC	Virtex-5 LX330 FPGA
Tx/Rx antennas	4	4
Modes [2]	MCS 0–31	MCS 0–31
Bandwidth	20–MHz, 40–MHz	20–MHz, 40–MHz
Guard Interval (GI)	short, long	short, long
Operating speed	160–MHz	20 MHz
Throughput	6...600 Mbps	(not real-time)
Area	1757 kGE	≈ 75% (Table 3)

standard [2]. The transceiver handles up to four spatial data streams with four antennas both at the transmitter and at the receiver. The design supports a total of 76 MCSs, most of them both in 20 MHz channels (data rates up to 289 Mbit/s) and in 40 MHz channels (data rates up to 600 Mbit/s), with short or long guard interval, in two different packet formats (Greenfield and mixed format), giving rise to hundreds of modes of operation.

The different blocks of the transceiver are arranged linearly and attached to each other by handshake interfaces. This processing paradigm holds not only for the top level blocks shown in Figure 7, but also across all levels of hierarchy. The handshake interfaces allow operating the top-level of the design (as well as the lower hierarchies) at transaction-level. In addition to the welcome side-effect, that plugging in new or revised blocks into the design is much easier with a standardized handshake interface, the operation of different design representations is simplified considerably. In fact, transaction-level operation is equally well suited for timed (e.g., RTL models) and untimed (e.g., MATLAB models) design representations and eases the design of the corresponding testbenches. For instance, transaction-based stimuli alleviate the FPGA emulation, since cycle-accurate delivery of the stimuli is not required which relaxes the requirements on the corresponding testbench implementation.

In our baseband-transceiver case study, port adapters are used to transfer baseband samples, thermal noise samples, transmit and receive payload data, and to monitor internal nodes of the design. For debugging purposes, a (one bit) frame start trigger signal is available in a separate port adapter. The clock frequency of the SDRAM was set to 133 MHz and the clock frequency of the PCIe core was set to 65 MHz. The DUV interfaces operate at 20 MHz, which corresponds to 1/8 of its real-time target clock frequency achieved on a dedicated 130 nm CMOS ASIC process. The configuration interface of the DUV is a standardized advanced microcontroller bus architecture (AMBA) advanced high-performance bus (AHB) which is connected in the FPGA testbench through a PCIe-to-AHB bridge. The system has been realized on a HAPS-52 [33] prototyping board by Synplicity (now Synopsis) featuring two Virtex-5 LX330 FPGAs, a plug-in SDRAM board, and a PCIe interface. The entire setup is realized on one of the two

TABLE 3: FPGA resources (total and relative to available).

	Registers	Lookup Tables
Port adapters (7 instances)	9148 (4.4%)	8770 (4.2%)
PCIe	6823 (3.3%)	7853 (3.8%)
802.11n design	74723 (36.0%)	166541 (80.3%)

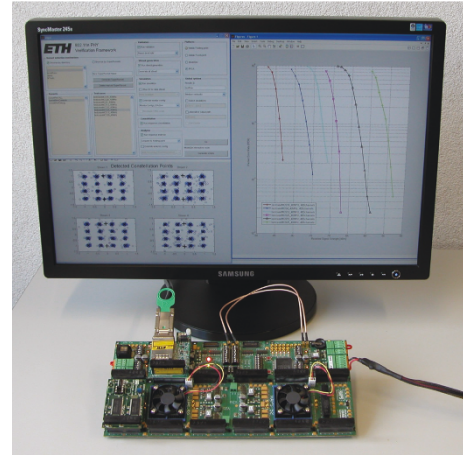

FIGURE 8: Verification environment software (on the screen: graphical user interface (GUI) and result plots) and FPGA emulation platform.

FPGAs. The corresponding resource utilization of the FPGA is summarized in Table 3. The utilization is specified relative to the resources available in *one* of the two Virtex-5 LX330 FPGAs [34] available on the HAPS-52 prototyping board. A picture of the test setup is shown in Figure 8, containing the graphical user interface (GUI), monitor output of received signal constellation points, packet-error rate curve, and a HAPS-52 board connected via PCIe to the host PC.

Compared to HDL simulation, the FPGA platform achieves a speed-up of two to three orders of magnitude. While the clock frequency of the DUV on the FPGA could easily be increased, the main performance bottleneck is due to the file handling operations in MATLAB. The MATLAB fixed-point simulation has a simulation speed that is comparable to the HDL simulation. Compared to FPGA emulation, the behavioral MATLAB floating-point simulation is slightly slower, but on the same order of magnitude. Note that with the proposed monitoring strategy the collection of large amounts of monitor data potentially decreases simulation speed on the FPGA significantly. This is because the number of reserved monitor output pins on the DUV is limited, so that for the observation of wider internal nodes or when monitoring several different internal nodes, the *same* simulation has to be run several times to collect the required bit-slices. Moreover, activated monitors also decrease the simulation speed of MATLAB simulations, due to additional file handling operations. A typical 802.11n packet reception on the FPGA emulation takes 0.1 to 2 seconds, depending on the packet size and modulation scheme.

## 6. Conclusions

Wireless communication testbeds have been instrumental for the investigation of the propagation environment in modern wireless communication systems and for early demonstrations of the technology. However, the testbed approach is often ill-suited for the VLSI development of industrial and standard-compliant products. The aim of this tutorial paper was to describe a design and verification methodology for wireless communication transceivers. The described approach is based on multiple design representations such as floating-point models, bit-accurate behavioral models, and register transfer level descriptions. To ensure consistency across these different design representations, a common verification framework is required. The described framework delivers consistent and 100% reproducible results. For the rapid fixed-point performance characterization, FPGA emulation is integrated into this framework using a generic FPGA emulation platform.

## Acknowledgments

The authors gratefully acknowledge the entire team of Celestrus Inc. Special thanks go to U. Schuster who played a major role in both designing and implementing the framework. Financial support from the Swiss National Science Foundation under project number PP002-119052 is also gratefully acknowledged.

## References

- [1] G. J. Foschini and M. J. Gans, "On limits of wireless communications in a fading environment when using multiple antennas," *Wireless Personal Communications*, vol. 6, no. 3, pp. 311–335, 1998.
- [2] IEEE draft P802.11n/D2.0, "Wireless LAN MAC and PHY specifications: enhancements for higher throughput," New York, NY, USA, February, 2007.
- [3] IEEE 802.16e-2005, "Local and metropolitan networks—part 16: air interface for fixed and mobile broadband wireless access systems, amendment 2: physical and medium access control layers for combined fixed and mobile operation in licensed bands and corrigendum 1," 2006.
- [4] "E-UTRAN: physical channels and modulation," 3GPP Std. TS 36.211, March 2009.
- [5] S. Haene, D. Perels, and A. Burg, "A real-time 4-stream MIMO-OFDM transceiver: system design, FPGA implementation, and characterization," *IEEE Journal on Selected Areas in Communications*, vol. 26, no. 6, pp. 877–889, 2008.
- [6] P. Murphy, F. Lou, A. Sabharwal, and J. P. Frantz, "An FPGA based rapid prototyping platform for MIMO systems," in *Proceedings of the 37th Asilomar Conference on Signals, Systems and Computers (ACSSC '03)*, vol. 1, pp. 900–904, Pacific Grove, Calif, USA, November 2003.
- [7] M. Wenk, P. Luethi, T. Koch, et al., "Hardware platform and implementation of a realtime multi-user MIMO-OFDM testbed," in *Proceedings of the IEEE International Symposium on Circuits and Systems (ISCAS '09)*, pp. 789–792, May 2009.
- [8] S. Caban, C. Mehlführer, R. Langwieser, A. L. Scholtz, and M. Rupp, "Vienna MIMO testbed," *EURASIP Journal on Applied Signal Processing*, vol. 2006, Article ID 54868, 13 pages, 2006.
- [9] T. Haustein, A. Forck, H. Gabler, V. Jungnickel, and S. Schiffermuller, "Real-time signal processing for multiantenna systems: algorithms, optimization, and implementation on an experimental test-bed," *EURASIP Journal on Applied Signal Processing*, vol. 2006, Article ID 27573, 21 pages, 2006.
- [10] R. Mostafa, R. Gozali, R. C. Palat, et al., "Design and implementation of a DSP-based MIMO system prototype for real-time demonstration and indoor channel measurements," *EURASIP Journal on Applied Signal Processing*, vol. 2005, no. 16, pp. 2673–2685, 2005.
- [11] J. W. Wallace, B. D. Jeffs, and M. A. Jensen, "A real-time multiple antenna element testbed for MIMO algorithm development and assessment," in *Proceedings of the IEEE Antennas and Propagation Society Symposium*, vol. 2, pp. 1716–1719, Monterey, Calif, USA, June 2004.
- [12] M. Rupp, C. Mehlführer, S. Caban, R. Langwieser, L. Mayer, and A. Scholtz, "Testbeds and rapid prototyping in wireless system design," *EURASIP Newsletter*, vol. 17, no. 3, pp. 32–50, 2006.
- [13] D. Ramírez, I. Santamaría, J. Pérez, et al., "A flexible testbed for the rapid prototyping of MIMO baseband modules," in *Proceedings of the 3rd International Symposium on Wireless Communication Systems (ISWCS '06)*, pp. 776–780, Valencia, Spain, September 2006.
- [14] R. M. Rao, S. Lang, and B. Daneshrad, "Field measurements with a 5.25 GHz broadband MIMO-OFDM communication system," *IEEE Transactions on Wireless Communications*, vol. 6, no. 8, pp. 2848–2859, 2007.
- [15] J. Garcia-Naya, M. González-López, and L. Castedo, "An overview of MIMO testbed technology," in *Proceedings of the 4th International Symposium on Image and Video Communications over Fixed and Mobile Networks (ISIVC '08)*, Bilbao, Spain, July 2008.
- [16] T. Kaiser, A. Wilzeck, M. Berentsen, and M. Rupp, "Prototyping for MIMO systems—an overview," in *Proceedings of the 12th European Signal Processing Conference (EUSIPCO '04)*, pp. 681–688, Vienna, Austria, September 2004.
- [17] R. M. Rao, W. Zhu, S. Lang, et al., "Multi-antenna testbeds for research and education in wireless communications," *IEEE Communications Magazine*, vol. 42, no. 12, pp. 72–81, 2004.
- [18] V. Erceg, et al., "TGn Channel Models," IEEE 802.11 document 03/940r4.
- [19] P. Goud Jr., R. Hang, D. Truhachev, and C. Schlegel, "A portable MIMO testbed and selected channel measurements," *EURASIP Journal on Applied Signal Processing*, vol. 2006, Article ID 51490, 10 pages, 2006.
- [20] A. I. Fabregas, M. Guillaud, D. Slock, et al., "A MIMO-OFDM testbed for wireless local area networks," *EURASIP Journal on Applied Signal Processing*, vol. 2006, Article ID 18083, 20 pages, 2006.
- [21] J.-W. Weijers, V. Derudder, S. Janssens, F. Petre, and A. Bourdoux, "From MIMO-OFDM algorithms to a real-time wireless prototype: a systematic matlab-to-hardware design flow," *EURASIP Journal on Applied Signal Processing*, vol. 2006, Article ID 39297, 12 pages, 2006.
- [22] M. Rupp, A. Burg, and E. Beck, "Rapid prototyping for wireless designs: the five-ones approach," *Signal Processing*, vol. 83, no. 7, pp. 1427–1444, 2003.
- [23] M. Graphics, "Catapult C synthesis," <http://www.mentor.com/>.
- [24] Y. Guo, D. McCain, J. Cavallaro, and A. Takach, "Rapid industrial prototyping and SoC design of 3 G/4 G wireless systems using an HLS methodology," *EURASIP Journal on Embedded Systems*, vol. 2006, Article ID 14952, 25 pages, 2006.

- [25] P. Belanovic, B. Knerr, M. Holzer, and M. Rupp, "A fully automated environment for verification of virtual prototypes," *EURASIP Journal on Applied Signal Processing*, vol. 2006, Article ID 32408, 12 pages, 2006.
- [26] H. Kaeslin, *Digital Integrated Circuit Design*, Cambridge University Press, Cambridge, UK, 2008.
- [27] D. Menard, D. Chillet, and O. Sentieys, "Floating-to-fixed-point conversion for digital signal processors," *EURASIP Journal on Applied Signal Processing*, vol. 2006, Article ID 96421, 19 pages, 2006.
- [28] M. Coors, H. Keding, O. Luthje, and H. Meyr, "Design and DSP implementation of fixed-point systems," *EURASIP Journal on Applied Signal Processing*, vol. 2002, no. 9, pp. 908–925, 2002.
- [29] D. Menard, R. Serizel, R. Rocher, and O. Sentieys, "Accuracy constraint determination in fixed-point system design," *EURASIP Journal on Embedded Systems*, vol. 2008, Article ID 242584, 12 pages, 2008.
- [30] E. Morales, G. Zucchelli, M. Barnasconi, and N. Jugessur, "Novel methodology for functional modeling and simulation of wireless embedded systems," *EURASIP Journal on Embedded Systems*, vol. 2008, Article ID 171358, 9 pages, 2008.
- [31] Synopsys, "Certify," <http://www.synopsys.com/Tools/Verification/HardwareAssistedVerification/Confirma/Pages/Certify.aspx>.
- [32] A. Burg, S. Haene, M. Borgmann, et al., "A 4-stream 802.11n baseband transceiver in 0.13  $\mu\text{m}$  CMOS," in *Proceedings of the IEEE Symposium on VLSI Circuits*, pp. 282–283, June 2009.
- [33] Synplicity, "HAPS-52 Virtex-5 Motherboard," <http://www.synopsys.com/Tools/Verification/HardwareAssistedVerification/Documents/haps-52-ds.pdf>.
- [34] Xilinx, "Virtex-5 family overview," [http://www.xilinx.com/support/documentation/data\\_sheets/ds100.pdf](http://www.xilinx.com/support/documentation/data_sheets/ds100.pdf).