



Using Simple Dilution Models to Predict New Zealand Estuarine Water Quality

David R. Plew¹ · John R. Zeldis¹ · Ude Shankar¹ · Alexander H. Elliott²

Received: 5 April 2017 / Revised: 15 February 2018 / Accepted: 16 February 2018 / Published online: 13 March 2018
© The Author(s) 2018

Abstract

A tool based on simple dilution models is developed to predict potential nutrient concentrations and flushing times for New Zealand estuaries. Potential nutrient concentrations are the concentrations that would occur in the absence of nutrient uptake or losses through biogeochemical processes, and so represent the pressure on a system due to nutrient loading. The dilution modelling approach gives a single time- and space-averaged concentration as a function of flow and nutrient input, with the capability to include seasonal nutrient and flow differences. This tool is intended to be used to identify estuaries likely to be highly sensitive to current nutrient loads based on their physical attributes, or to quickly compare the effects of different land-use scenarios on estuaries. The dilution modelling approach is applied both to a case study of a single New Zealand estuary, and used in a New Zealand-wide assessment of 415 estuaries. For the NZ-wide assessment, annual nutrient loads to each estuary were obtained from a GIS-based land-use model. Comparison with measured data shows that the predicted potential nitrate concentrations are significantly correlated with, but higher than, measured nitrate values from water quality sampling time series. This is consistent with expectations given that the measured concentrations include the effects of nitrogen uptake and loss. The estuary dilution modelling approach is currently incorporated into the GIS-land use model, and is also available as a web-app for assessing eutrophication susceptibility of New Zealand estuaries.

Keywords Estuaries · Water quality · Nutrient loads · Land-use change · Eutrophication · Susceptibility

Introduction

Estuaries are transitional water bodies between rivers and the sea, and their ecological states are influenced by both catchment and oceanic processes. For most estuaries, their trophic state is largely determined by nutrient and sediment loads originating from the catchment, particularly those for which land-use has intensified (National Research Council 2000). Eutrophication in estuaries is typically expressed as macroalgae or phytoplankton blooms. Macroalgae growth is strongly linked to nitrogen load (Fox et al. 2008; Robertson et al. 2016a), while phytoplankton biodiversity and biomass are driven by both nitrogen concentration and residence time

(Ferreira et al. 2005; National Research Council 2000). Because of this connection between catchment and estuary, authorities responsible for their management require tools that can predict estuary trophic state, and how that may be affected by land-use decisions. Tools for predicting or assessing estuary state have been developed in many parts of the world (Borja et al. 2008). These often form part of integrated assessment approaches that combine predictive tools to assess the pressure on an estuary from nutrient loading, with observational data that determine the actual ecological state (Whitall et al. 2007). A similar approach has recently been adopted in New Zealand with the development of the New Zealand Estuary Trophic Index (NZ ETI) (Robertson et al. 2016a; Robertson et al. 2016b). In this paper, we describe one of the predictive tools developed within the NZ ETI, to predict nutrient concentrations in and residence times of New Zealand estuaries.

Tools to predict how estuaries may respond to changes in nutrient inputs range from highly detailed coupled hydrodynamic-ecological computational models for individual estuaries to empirically based assessments that can be quickly applied across many systems. Each approach has advantages and drawbacks. Complex coupled hydrodynamic-

Communicated by Dennis Swaney

✉ David R. Plew
david.plew@niwa.co.nz

¹ NIWA, Christchurch, New Zealand

² NIWA, Hamilton, New Zealand

ecological models can be used to simulate water quality or ecosystem response across a range of spatial and temporal scales (Cerco and Noel 2013; del Barrio et al. 2014; Testa et al. 2013). These models provide high resolution and detail, but require considerable input data, parameterisation, computational time, calibration, validation and modeller skill (Ganju et al. 2016). Similar or simplified hydrodynamic model-based approaches can be applied across a region to estimate flushing times and concentrations of conservative constituents in multiple embayments or estuaries (Abdelrhman 2005). Although these complex hydrodynamic or ecological modelling approaches can provide accurate and detailed information, their predictions are specific to the water bodies resolved within the model, and new models need to be created each time a different water body is to be studied. There is still a need for predictive tools that are simple and easy to use, and quickly provide an estimate of present or future estuary state.

Approaches which are more easily applied and generalised across diverse estuary size and types are particularly valuable as screening tools to identify which estuaries may be under most pressure, to prioritise more detailed investigations or to quickly compare scenarios (e.g. changes in catchment land use). They are also useful in assembling generic ‘State of Environment’ assessments at regional or national scales (Borja et al. 2008). In New Zealand, local and central government authorities are increasingly tasked with these management responsibilities (Dudley et al. 2016). New Zealand has approximately 450 estuaries of great diversity in size and type (Hume et al. 2016; Hume et al. 2007). These different systems exhibit a range of physiography including depth, stratification, turbidity, tidal exchange, mixing and residence time. Examples include coastal lakes which are essentially closed to the sea with no tidal exchange (and by most definitions not considered to be true estuaries), tidal lagoons which may be vertically well mixed, and fjords and river mouths which may be strongly stratified. Thus, the relative importance of physical processes that govern the exchange between riverine and oceanic waters varies between estuary type, and may also vary between two estuaries of the same type. These physiographic features have been described as ‘filters’ which modulate differing responses of different estuary types to nutrients (Hughes et al. 2011). Incorporating this diversity presents a challenge when developing generalised tools for predicting estuary trophic state.

Relatively simple tools for predicting estuary state have been developed in many parts of the world (Borja et al. 2008), including Assessment of Estuarine Trophic Status (ASSETS) (Bricker et al. 1999; Bricker et al. 2003), Coastal Eutrophication Risk Assessment Tool (CERAT) (Sanderson and Coade 2010) and the USEPA E-Estuary (Abdelrhman 2005; Abdelrhman 2007; Hagy et al. 2000). Some of these approaches were developed with certain estuary types in mind, or empirically derived based on regional climate,

catchment topography and land use (Sanderson and Coade 2010), and are not readily transferable to other regions or countries. A challenge facing New Zealand authorities is that many of the estuaries of concern are small, and often data describing the estuaries are limited. In New Zealand, over half of identified coastal hydrosystems (Hume et al. 2016; Hume et al. 2007) have volumes that are too small to fit within ASSETS bandings for calculating dilution potential (Bricker et al. 1999; Bricker et al. 2003). Consequently, an approach relevant to New Zealand is required that needs minimal input data, yet has useful predictive capability across a diversity of estuary sizes and types.

Here, we have developed simple models to estimate dilution within an estuary, from which flushing times and potential nutrient concentrations within the estuary are predicted. The descriptor ‘potential’ is used because the tool predicts the concentration in the absence of non-conservative processes such as denitrification or uptake by algae after dilution. Observed nutrient concentrations (such as measured in typical water quality sampling) within a water body may often be lower than potential concentrations due to these processes, especially during periods of high seasonal plant growth and nutrient depletion (Bricker et al. 2003). At such times, a high (potentially eutrophic) biomass of algae may take up a large proportion of nutrient from the water column such that observed (measured) nutrients may be in comparatively low concentrations. Such measures may therefore be misleading when the information is used in assessments of trophic state with respect to nutrient concentration thresholds (Bricker et al. 2003). In contrast, potential concentration is directly related to the areal nutrient loads the system is receiving (after dilution). Nutrient load has been found to link strongly with macroalgal cover in New Zealand (Robertson et al. 2016a) and overseas (Fox et al. 2008). Similarly, for suspended algae (phytoplankton), nutrient loads and residence time have been found to be better predictors of phytoplankton biodiversity and biomass (Ferreira et al. 2005; National Research Council 2000) than observed nutrient concentrations, particularly during nutrient limited phases of the annual cycle (Bricker et al. 2003).

The dilution modelling approach described in this study is intended to be used firstly as a screening tool identifying regionally or nationally which estuaries are at risk of nutrient-driven eutrophication issues (and hence prioritise more detailed investigations), and secondly to allow scenario testing to see how individual estuaries, or estuaries within a region, may respond to changes in nutrient loads such as from land-use changes. To date, this approach has been used for assessments of individual estuaries, embedded within a GIS catchment nutrient model (Elliott et al. 2016), and made available as a web-based tool to predict eutrophication susceptibility on a regional or New Zealand-wide basis (Zeldis et al. 2017). In the following sections, the dilution modelling approach is described, and two applications are given: an assessment of a

single estuary and a NZ-wide estuary assessment using estimates of annual nutrient loads obtained from a GIS catchment model.

Methods

Estuary Physiography and Nutrient Load Data

Physical parameters for estuaries were obtained from the Coastal Explorer database (Hume et al. 2007), which contains data for over 400 New Zealand estuaries. The data within the database were collated from a variety of sources including bathymetry charts, aerial photographs, tidal models and various estuary studies (Hume et al. 2007). In this study, only tidal prism and volume at high tide were used from this database.

Freshwater inflows and nutrient loads were obtained from a land use model developed for New Zealand. Catchment Land Use for Environmental Sustainability (CLUES) model (Elliott et al. 2016) is a GIS-based modelling system that predicts the impact of land-use changes on water quality and socio-economic indicators. CLUES is built on a number of sub-models including SPARROW (Schwarz et al. 2006), OVERSEER (Roberts and Watkins 2014; Shepherd and Wheeler 2013; Shepherd et al. 2013; Wheeler et al. 2014) and SPASMO (Rosen et al. 2004). Relevant to the current study, CLUES predicts terminal reach water flows, total nitrogen (TN) and total phosphorus (TP) loads. Unwin et al. (2010) used a machine learning approach to relate various water quality parameters to catchment properties such as topography, climate, flow, geology and land cover. From their model, we obtained predictions for the $\text{NO}_3\text{-N}$ fraction of TN, and dissolved reactive phosphorus (DRP) fraction of TP, for each estuary. We used these fractions to convert CLUES-derived TN and TP loads to $\text{NO}_3\text{-N}$ and DRP loads, respectively. The predictions made by CLUES are annual loads, and are not time-varying. We converted loads to concentrations (g m^{-3}) using mean annual flow rate.

Oceanic boundary conditions for nutrient concentrations, and salinity and temperature for the ACEXR model (described further in the 'ACEXRS14' section), were taken from the CARS 2009 climatology (CSIRO 2011) using the coastal element of the climatology containing the estuary in question.

Dilution Models

Our dilution models determine the amount of mixing between the incoming freshwater and ocean water within the water body of interest. The models are used to calculate a dilution factor, D , where $1/D$ is the fraction of freshwater

in the estuary. The dilution factor can be used to estimate the concentration of a tracer within the water body as follows

$$C = \frac{C_R}{D} + C_O \left(1 - \frac{1}{D}\right) \quad (1)$$

where C is the concentration in the water body, C_R is the concentration in the inflow and C_O is the concentration in the ocean. The dilution factor can be used to predict estuary salinity S by setting $C_R=0$ and $C_O=S_O$ (ocean salinity) in Eq. (1), or alternatively, if salinity is known, it provides a means by which the dilution factor can be estimated,

$$D = \frac{S_O}{S_O - S} \quad (2)$$

The reciprocal of the dilution factor gives an indication of the sensitivity of the concentration in a water body to changes in concentration in the inflows in terms of the ratio ΔC of the excess concentration (the increase above ocean concentration) in the estuary to the excess concentration in the inflow,

$$\Delta C = \frac{C - C_O}{C_R - C_O} = \frac{1}{D} \quad (3)$$

Four models are used to derive a steady state, spatially and temporally averaged dilution factor for an estuary. The choice of which model is used depends on physical parameters of the estuary, as will be described below.

Tidal Prism

The tidal prism model is a very basic approach for estimating dilution. It is assumed that the estuary is fully mixed, that entrainment and therefore estuarine circulation is negligible and that no outgoing flow returns to the estuary. This approach treats the tidal exchange as a continuous inflow and outflow. Dilution is calculated as follows:

$$D = \frac{P + Q_F T}{Q_F T} \quad (4)$$

where Q_F is the freshwater inflow ($\text{m}^3 \text{s}^{-1}$), T is the tidal period (12.42 h = 44,712 s) and P is the volume of the tidal prism (m^3).

Luketina Tidal Prism

Luketina (1998) noted several flaws in the simple tidal prism model, and derived a more theoretically correct model. This model allows for differences in the duration of the flood and ebb tides (river flow increases the duration of the ebb tide with respect to the flood tide), and incorporates a tuning parameter,

called a return flow factor b , which is intended to account for the portion of the water entering the estuary from the ocean on the flood tide that had flowed out of the estuary on the previous ebb tide. The return flow reduces dilution within an estuary.

Luketina gives equations for salinity (Eq. 26, Luketina 1998), which we convert to a dilution factor using Eq. 2 to obtain

$$D = \frac{P(1-b) + \frac{Q_F T}{2}(1+b)}{Q_F T} \tag{5}$$

Equation 2 describes how a dilution factor can be calculated from measured salinities. By re-arranging Eq. (5), the return flow factor b can be derived from dilution, and therefore salinity:

$$b = \frac{Q_F T \left(\frac{S_O - 1}{S_O - S} - \frac{1}{2} \right) - P}{\frac{Q_F T}{2} - P} \tag{6}$$

This model is applicable for well-mixed estuaries ($Q_F T/P \leq 0.1$), although Luketina notes that it is possible for reasonably well-mixed estuaries to have $Q_F T/P$ up to 0.25.

The relative concentration increase in the estuary ΔC is a function of both the tuning factor b and the ratio of fresh-water inflow to tidal prism. A contour plot of the relative concentration increase (see Eq. 3) is shown in Fig. 1. The relative concentration in the estuary increases both with b and with increasing freshwater inflow (relative to tidal prism).

A key assumption underlying the Luketina tidal prism model is that the estuary is uniformly (and instantly) mixed. In practice, estuaries are seldom homogeneously mixed and there can be large gradients in salinity between the inflowing rivers and the mouth. Much of the flow that leaves the estuary

on the outgoing tide is the higher salinity water near the mouth. To obtain estuary-averaged mean salinities from the Luketina model in these cases requires using significantly higher return flow factors than the actual proportion of water re-entering the estuary on each tide. Although Luketina (1998) suggests a default value of $b = 0.5$, comparison with salinity field data (see Fig. 2 and ‘Application and ResultsS9’ section below for an example) suggests higher values are required for many estuaries to give results that emulate estuary-mean salinities. Because the value of b is often higher than the actual return flow, it will be referred to a ‘tuning factor’ in what follows.

Predictions of estuary salinity and nutrient concentrations are sensitive to the tuning parameter b . Ideally, this parameter would be calculated for each estuary using salinity data. As suitable data are only available for a few New Zealand estuaries, a method to predict b was required. Sandford et al. (1992) presented a methodology for estimating the return flow fraction for small embayments, but this requires parameters not readily available for all estuaries (cross-sectional area of the mouth, along-shore current speed, offshore depth). Furthermore, as discussed, the required value of the tuning parameter is likely to be higher than the actual return flow. Consequently, here we have used salinity data measured in a number of estuaries to derive a predictor for the tuning parameter b . Dudley et al. (2016) compiled salinity data from regional and city councils for 45 New Zealand estuaries and coastal embayments. For many of these systems, measurements were collected at a single location only, which is unlikely to provide an accurate estimate of mean estuary salinity. There remained 11 systems for which estuary physical properties (tidal prism, freshwater inflow) were known, and with multiple sampling sites enabling a representative estimate of mean salinity. These were generally larger systems (volumes between 9.5×10^6 and $1.3 \times 10^{10} \text{ m}^3$, Table 1). The Luketina

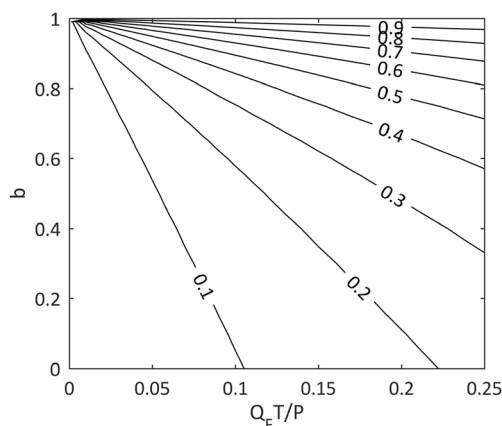

Fig. 1 Contour plot of relative concentration increase ΔC as a function of the ratio of freshwater inflow to tidal prism ($Q_F T/P$) and tuning factor b for the Luketina tidal prism model

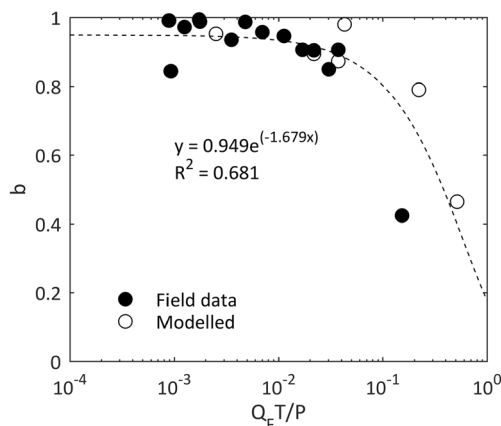

Fig. 2 Return flow fraction b calculated from salinity data as a function of the ratio of freshwater inflow over a tidal period to tidal prism. The dotted line shows a regression fit to the data

tuning parameter b was calculated for each estuary using a simple average of all measured salinities. Additional data were added using output from 3-D hydrodynamic models developed under other studies, and field data from two smaller estuaries (Okains Bay Estuary and Le Bons Bay Estuary, Plew et al. 2017). Note that two different mouth configurations are included for one estuary (Kakanui Estuary, Table 1). Salinities from the 3D hydrodynamic models and field data from the two additional estuaries were taken at high tide. The value of b was thus estimated using data for $Q_F T/P < 0.52$. Exponential regression through all observed and measured data (Fig. 2) was used to predict b as a function of freshwater inflow to tidal prism:

$$b = 0.949 \exp\left(-1.679 \frac{Q_F T}{P}\right) \quad (7)$$

The tuning parameter b was high (> 0.8) for most estuaries for which field data were available, but decreased with increasing $Q_F T/P$ (Fig. 2). The ratio of fresh-water inflow to tidal prism was small ($Q_F T/P < 0.1$) for most estuaries shown in Fig. 2, and the spread in b appears to increase at high freshwater to tidal prism ratios. This may indicate that the tuning factor is more variable among estuaries with high fresh water inputs relative to tidal prism, which tend to be smaller, shallow, short residence time tidal river estuaries. While only estuaries with multiple sampling sites were used to give an estimate of mean estuary salinity, in most estuaries these were surface samples located at the shoreline. Many samples were also collected at times other than high tide. These sampling factors may reduce the observed estuary salinity, and consequently produce higher estimates of b . This bias would be greater in systems with large tidal prisms relative to volume, and where systems were strongly stratified. Most of the observed data were from large systems, while the modelled data and observations from small estuaries (Okains Bay and Le Bons Bay) were volume averaged at high tide. Therefore, we assume that any bias in b is small.

For consistency, we have used Eq. (7) for all estuaries in this study, but reiterate that estuary-specific salinity data, collected at high tide and at sufficient locations and depths to obtain a true volume averaged salinity, will give improved estimates of dilution for individual estuaries. Equation (7) should be re-evaluated when more salinity data become available, particularly for estuaries with high freshwater inputs relative to tidal prism.

Freshwater Systems

Luketina (1998) showed that Eqs. 5–6 are valid for $Q_F T/\pi P \ll 1$. As the value of 1 is approached, the length of the flood tide reduces until there is no flood flow. In the absence of

estuarine circulation, no sea water will enter the estuary. Luketina also shows that the salinity at high tide decreases to zero at $Q_F T/\pi P \sim 0.44$. We therefore assume that the estuary is freshwater dominated when $Q_F T/P \geq 1.38$ and assign a dilution of $D = 1$. For these systems, the apparent tidal prism (the difference in water volume between high and low tide) consists of freshwater that accumulates within the estuary or lagoon because the outflow to the sea is impeded by the tidal fluctuations of the sea level. The assumption that no sea-water enters the system (e.g. ignoring estuarine circulation) will lead to conservatively high predictions of potential nutrient concentrations, but we consider that for a screening tool, this is preferable to underestimating concentrations. Coastal lakes which have no tidal prism are also modelled as consisting of predominantly freshwater and we assign $D = 1$. We assume that they have constant volume, and that the freshwater inflow is equalled by outflow to the sea. We also assume that any inflow from the ocean or wave overtopping is negligible and ignore any losses to evaporation.

ACExR

ACExR is a time-dependent box model of exchange and mixing processes originally developed for fjord-like systems (Gillibrand et al. 2013). For this application, the model represents the estuary as two horizontally uniform (mixed) layers. The model calculates the volume, thickness, salinity and temperature of each layer. The model is forced with wind stress, river discharge, surface heat flux, tide and boundary conditions of oceanic salinity and temperature profiles. The estuary is assumed to have a fixed total volume, and tides treated as a constant inflow/outflow from the lower layer. The freshwater inflows are added to the upper layer, and the outflow from this layer consists of the inflow plus water entrained from the lower layer via the estuarine circulation process.

A modified form of the original ACExR model is used because the input data are generally limited. A simplified hypsography is used, derived from the volume of the estuary at high and low tide, assuming that the estuary (in cross-section) is the shape of an elongated inverted triangle. The original ACExR model also has a third layer of deeper water for systems with sills (not used here). For the CLUES-estuary tool, ACExR is run for a 28 model day period to obtain a steady state solution for salinity, from which an estuary-averaged dilution factor is calculated. Wind forcing for ACExR was obtained from the nearest of 18 meteorological stations across New Zealand using hourly wind speed and direction from the year 2008.

To efficiently incorporate results of the ACExR model, the steady state results of simulations run across a range of inflows for all New Zealand estuaries contained in the New Zealand Coastal Explorer database (Hume et al. 2007) were stored and used to obtain a regression equation between

Table 1 Estuaries with measured or modelled salinities used to determine a relationship to predict the return flow factor. Volumes and tidal prism are from either the Coastal Explorer database (Hume et al. 2007) or derived from bathymetry data used in hydrodynamic models. Freshwater inflows are annual means predicted by CLUES (Elliot et al. 2016), or the values used in the hydrodynamic models. Salinity data are averaged from at least five sites at each estuary (Dudley et al. 2016), or volume-averaged salinities at high tide for modelled data

Estuary	Hume et al. (2007) type	ETI type	Lat (°S)	Lon (°E)	Volume (m ³)	Tidal prism (m ³)	River inflow (m ³ s ⁻¹)	Salinity ratio S/S ₀	Return flow factor b
Avon-Heathcote	F	SIDE	43.564	172.749	8.194 × 10 ⁶	6.376 × 10 ⁶	3.113	0.813	0.904
Kaipara Harbour	F	SIDE	36.418	174.164	4.260 × 10 ⁹	1.615 × 10 ⁹	127.7	0.948	0.935
Manukau Harbour	F	SIDE	37.047	174.527	1.333 × 10 ⁹	710.1 × 10 ⁶	14.17	0.912	0.991
New River Estuary	C	SIDE	46.507	168.272	48.50 × 10 ⁶	50.74 × 10 ⁶	42.37	0.712	0.906
Opua Inlet System	F	SIDE	35.244	174.099	211.5 × 10 ⁶	900.0 × 10 ⁶	22.70	0.826	0.946
Pelorus Sound	H	DSIDE	40.945	174.086	13.15 × 10 ⁹	932.0 × 10 ⁶	26.20	0.957	0.972
Porirua Harbour	E	SIDE	41.094	174.863	17.04 × 10 ⁶	7.413 × 10 ⁶	2.810	0.846	0.906
Queen Charlotte Sound	H	DSIDE	41.090	174.380	9.347 × 10 ⁹	455.5 × 10 ⁶	9.458	0.994	0.843
Tauranga Harbour System	F	SIDE	37.638	176.156	382.2 × 10 ⁶	211.5 × 10 ⁶	33.26	0.858	0.957
Te Puna /Kerikeri Inlet	F	SIDE	35.204	174.069	159.2 × 10 ⁶	647.9 × 10 ⁶	6.966	0.730	0.987
Waitemata Harbour	F	SIDE	36.839	174.818	292.4 × 10 ⁶	177.0 × 10 ⁶	6.986	0.871	0.988
Whangarei Harbour	F	SIDE	35.848	174.513	375.8 × 10 ⁶	148.2 × 10 ⁶	5.742	0.771	0.994
Okains Bay Estuary	n/a	SIDE	43.694	173.055	285.9 × 10 ³	246.1 × 10 ³	0.167	0.831	0.849
Le Bons Bay Estuary	n/a	SIDE	43.746	173.095	74.80 × 10 ³	54.12 × 10 ³	0.185	0.777	0.424
Kakanui (model)	B	SSRTRE	45.187	170.898	547.0 × 10 ³	208.4 × 10 ³	2.4	0.436	0.464
Kakanui (model)	B	SSRTRE	45.187	170.898	547.0 × 10 ³	217.7 × 10 ³	1.08	0.457	0.790
New River Estuary (model)	C	SIDE	46.507	168.272	48.50 × 10 ⁶	50.74 × 10 ⁶	42.37	0.770	0.873
Avon-Heathcote (model)	F	SIDE	43.564	172.749	8.194 × 10 ⁶	6.376 × 10 ⁶	3.113	0.828	0.894
Waihou (model)	B	SSRTRE	37.170	175.542	39.16 × 10 ⁶	25.00 × 10 ⁶	24	0.315	0.980
Whangarei Harbour (model)	F	SIDE	35.848	174.513	270.1 × 10 ⁶	115.5 × 10 ⁶	6.5	0.950	0.952

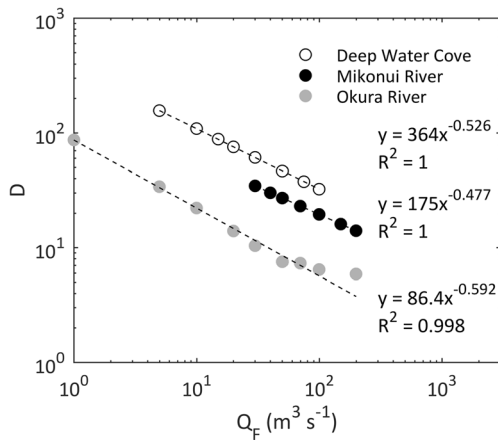

Fig. 3 Example output of ACEXR model showing the relationship between dilution factor D and freshwater inflow Q_F for three estuaries. Each of the three estuaries correspond to a different estuary type according to the New Zealand Estuary Trophic Index classification (deep water cove = DSDE, Mikonui River = SSRTRE, Okura River = SIDE)

inflow and dilution for each estuary. The regression equations had the form

$$D = A Q_F^B \tag{8}$$

where A and B are regression coefficients specific to each estuary. Regression coefficients were calculated for 346 estuaries, and the average R^2 of these regressions was 0.988 with a minimum of 0.791. Figure 3 shows examples of the relationship between dilution and freshwater inflow for three estuaries. The estuaries shown include three of the estuary types according to the classification system used in the New Zealand Estuary Trophic Index (Robertson et al. 2016a; Zeldis et al. 2017) which is described further in ‘Estuary Classification’ section. This distillation of simulation results is used when the ACEXR model is selected by the model selection decision-tree (see below) as the most appropriate model. There were a further 69 estuaries for which either input data were missing, ACEXR did not provide steady state solutions or the regression equations had poor fit. However, there were no instances where the

ACEXR model was selected for estuaries for which the regression coefficients could not be calculated.

Model Selection

We have described four models for estimating dilution and potential nutrient concentration applicable to New Zealand estuaries. The process for selecting which model is applied follows the steps below and is illustrated in Fig. 4:

1. Coastal lakes and estuaries normally closed to the sea, or open but have no tidal prism (i.e. the tidal prism $P = 0$), are assigned a dilution of $D = 1$.
2. If the river inflow is high compared to the tidal water level variation inside the estuary, i.e. $Q_F T / P \geq 1.38$, then there is no tidal inflow (Luketina 1998). The ‘estuary’ is dominated by freshwater (i.e. a freshwater lagoon or, as known in New Zealand, ‘hapua’) and a dilution of $D = 1$ is used.
3. Deep estuaries, such as fjords, are likely to be stratified. The ACEXR model is appropriate for such systems. A value of $P / V_{mid} < 0.09$ (Hume et al. 2007) is used to define a deep estuary, where V_{mid} is the volume at mid-tide. Substituting $V_{mid} = V + P/2$ gives a criterion of $P / V < 0.086$ defining a deep estuary.
4. An estuary is likely to be well mixed when the volume of freshwater entering the estuary over a tidal period is less than 10% of the tidal prism, $Q_F T / P \leq 0.1$, and partially mixed for $Q_F T / P < 0.25$ (Luketina 1998). The Luketina model gives the lowest estimates of dilution, and consequently the highest estuarine nutrient concentrations. As the intention is to produce a tool for managing nutrient loads to estuaries, we have chosen to be conservative by using the model that produced the lowest dilution for this situation. The Luketina model is applied for $Q_F T / P < 0.25$.
5. If the ratio of freshwater to tidal prism is higher than 0.25 but the estuary is shallow, then the estuary is still likely to be well mixed. The estuary is considered shallow if $P / V > 0.5$. The Luketina model is used in this case.

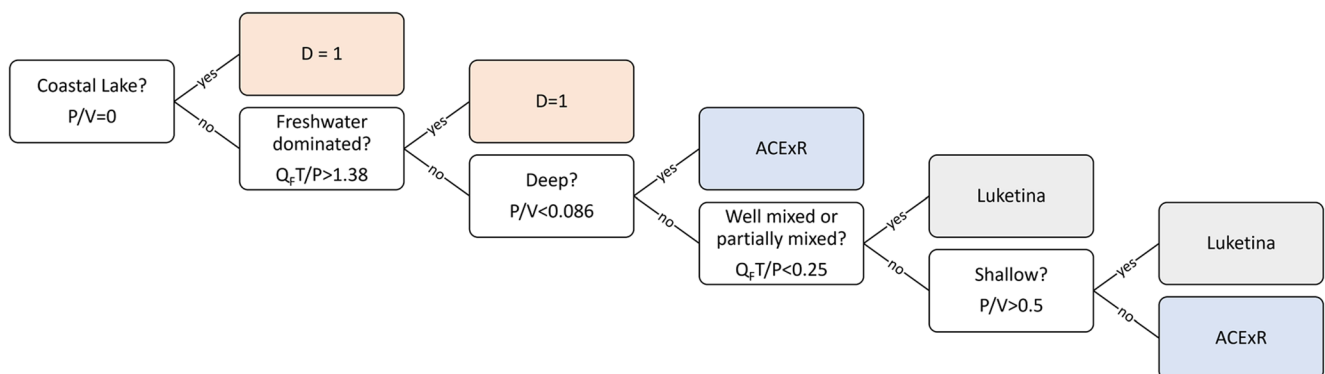

Fig. 4 Estuary model selection decision tree. Q_F is the freshwater inflow ($m^3 s^{-1}$), T the tidal period (44,700 s), P the tidal prism (m^3) and V the estuary volume at low tide (m^3)

6. If the tidal prism is small relative to estuary volume ($P/V \leq 0.5$), the estuary is likely to be stratified with a strong estuarine circulation process and the regressions derived through pre-application of the ACEXR model are used.
7. If the Luketina or ACEXR models do not provide a solution for the system of interest, then the simple tidal prism model provides a default dilution value.

Flushing Time

As noted previously, phytoplankton biomass is influenced both by nutrient concentration and residence or flushing time (Ferreira et al. 2005; National Research Council 2000). While the terms ‘residence time’ and ‘flushing time’ have, at times, been used interchangeably, others make a distinction between flushing time (a bulk or integrative parameter) and residence time (how long a parcel of water, starting from a specified location within a water body, takes to leave the water body) (Monsen et al. 2002; Sheldon and Alber 2002). The dilution models used here provide a time- and space-averaged predictor of estuary conditions, which is consistent with the use of a bulk time-scale parameter such as flushing time. Therefore, we characterise estuaries using flushing time T_F , defined as the time required for the cumulative freshwater inflow to equal the amount of freshwater originally in the water body (Dyer 1973). Noting that the volume of freshwater in the estuary at high tide is $(V+P)/D$, where V is the estuary volume at low tide and P the tidal prism, the time-scale to replace the freshwater in the estuary is

$$T_F = \frac{V + P}{DQ_F} \quad (9)$$

The flushing time for freshwater systems simplifies to $T_F = (V + P)/Q_F$.

Estuary Classification

To describe how our model selections were distributed across estuary types, we used the Coastal Explorer database (Hume et al. 2007), which divided New Zealand estuaries into eight classes based on physical parameters such as tidal prism, estuary volume, river flow, mouth closure index, and shape. This classification included systems that are not strictly estuaries (coastal lake-type lagoons and river mouth lagoons), described by Kirk and Lauder (2000) as primarily freshwater systems with no tidal inflow. Another classification within the New Zealand Estuary Trophic Index (ETI) (Robertson et al. 2016a; Zeldis et al. 2017) used a smaller number of categories for estuaries consisting of coastal lakes, shallow intertidal-dominated estuaries (SIDEs), shallow, short residence time tidal river and tidal river with adjoining lagoon (SSRTREs) and deeper subtidal-dominated longer residence time estuaries (DSDEs). Estuaries that intermittently open or close to the sea

were called intermittently closed/open estuary (ICOEs), and are subtypes of SIDEs and SSRTREs. Both the eight-level Hume et al. (2007) and four category classification in the NZ ETI project are used here. A mapping between the Hume et al. (2007) and ETI estuary types, and how they correspond to the dilution model selections, is described in Table 2. Coastal lakes are maintained as a separate type, while ICOEs are considered subcategories of SIDEs or SSRTREs. Tidal river mouths and tidal river lagoons are mapped to SSRTREs, tidal lagoons and barrier-enclosed lagoons to SIDEs and coastal embayments, fjords and sounds to DSDEs.

Case Study—New River Estuary

We illustrate the use of our dilution modelling approach with a case-study of the New River Estuary in southern New Zealand (46.47° S, 168.32° E; Fig. 5). This estuary is used as a case study because it experiences high macroalgae biomass driven by catchment nutrient loads (Robertson et al. 2016a). It also has an extensive time-series of water quality observations (Dudley et al. 2016), and a calibrated 3D hydrodynamic model (unpublished modelling study using DELFT3D; R. Measures NIWA, pers. comm., May 2016) which we use here as a check on the predictions made by the dilution modelling.

The New River Estuary is classified as a type *F*: *barrier-enclosed lagoon* (Hume et al. 2007) or shallow intertidal-dominated estuary (SIDE) (Robertson et al. 2016a). It has a mean tidal prism of $51 \times 10^6 \text{ m}^3$, low water volume of $33 \times 10^6 \text{ m}^3$ and mean annual inflows of $42 \text{ m}^3 \text{ s}^{-1}$. CLUES predicted an annual nitrogen load of 3618 T year^{-1} . A wastewater treatment plant discharges an additional 250 T year^{-1} nitrogen direct to the estuary, giving a present day loading of $\sim 3868 \text{ T year}^{-1}$.

Water quality sampling has been conducted by the local council at eight sites within the estuary at weekly intervals

Table 2 Estuary types in the Coastal Explorer database, and equivalent estuary type according to the NZ Estuarine Trophic Index (ETI). Estuary types used in the ETI are shallow short residence time river estuary (SSRTRE), deep subtidal-dominated estuary (DSDE) and shallow intertidal-dominated estuary

Hume et al. (2007) type	Descriptive name	ETI estuary type
A	Coastal lake	Coastal lake
B	Tidal river mouth	SSRTRE
C	Tidal river lagoon	SSRTRE
D	Coastal embayment	DSDE
E	Tidal lagoon	SIDE
F	Barrier-enclosed lagoon	SIDE
G	Fjord/Sound	DSDE
H	Sound	DSDE

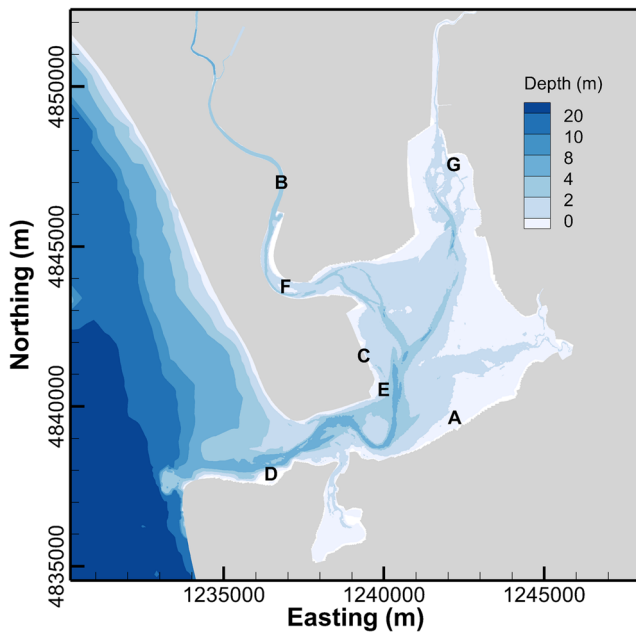

Fig. 5 Map of the New River Estuary (southern South Island, New Zealand) showing locations of Invercargill City Council water quality monitoring sites

since 1991 (Fig. 5) (Dudley et al. 2016). Volume-averaged salinity and total nitrogen concentration was estimated by drawing lines equidistant from each sampling location and calculating the volume contained within each resulting Thiessen polygon.

Output from the hydrodynamic model was used to determine volume-average salinities, and to estimate the actual return flow fraction. The concentration of a tracer was set to an initial value of 1 unit inside the estuary at high tide, and 0 units outside. The model was run for a tidal cycle (mean tidal range) and the mass flux of the tracer through the mouth on the incoming tide used to calculate what fraction of the incoming tidal prism consisted of water that had left the estuary on the outgoing tide.

Comparison with New Zealand-Wide Estuary Nutrient Data

Nutrient data from a number of estuary and coastal sites have been collated from New Zealand local government (regional and city councils) (Dudley et al. 2016). These observed data are compared here to potential nutrient concentrations predicted by the dilution models. Nutrient data were collected as part of various monitoring programmes. The location of sites, sampling methods and times of sampling (relative to tide) varied between regions and estuaries in Dudley et al. (2016). Because of the variations in sampling strategies, and because the predicted potential nutrient concentrations are potential values (i.e. exclude non-conservative processes), they are not directly comparable with field observations. Instead,

comparisons are made to see if there is a relationship between predicted potential nutrient concentrations and observed concentrations. We expect that predicted potential nutrient concentrations will be greater than observed concentrations (due to the non-conservative processes). However, we also expect that if the combination of land-use models and estuary dilution models used to predict potential concentrations are performing well, there will be a positive correlation with the slope providing an indication of the influence of nutrient sinks or sources in estuaries.

Application and Results

Case Study—New River Estuary

The dilution model selection procedure (see ‘Model Selection’ section) identified that the Luketina tidal prism model should be applied for the New River Estuary case ($P/V_{\text{mid}} = 0.88$, $Q_F T/P = 0.038$). From Eq. 7, the predicted tuning parameter $b = 0.89$.

The volume-average mean salinity derived from field data was 22.81 ppt (note this differs from the value in Table 1 due to the use of volume-averaging here versus simple averaging across all sites for data in Table 1). Using a mean ocean salinity of 34.3 ppt (from CARS climatology), the ratio $S/S_0 = 0.67$. If only salinities recorded at high tide were used, this ratio increased to $S/S_0 = 0.77$. The Luketina model was developed for high tide volumes (Luketina 1998), thus the higher value of $S/S_0 = 0.77$ is used to calculate $b = 0.87$.

The hydrodynamic model gave volume-averaged salinity within the estuary as a ratio to oceanic salinity varying between 0.58 at low tide and 0.80 at high tide, giving $b = 0.85$. These modelled and observation-based estimates of b have been used in deriving the predictive relationship (Eq. 11, see Table 1), so it is not surprising that there is good agreement between the three estimates of b .

The hydrodynamic model predicted that 29% of the incoming tidal prism consisted of water that had been in the estuary at the previous high tide, significantly lower than $b = 0.85$ – 0.89 estimated from the hydrodynamic model and field data. As noted previously, this discrepancy is because the estuary is not uniformly mixed and therefore b in the context of this dilution model application is best thought of a tuning parameter rather than a true return flow fraction (such as calculated by the hydrodynamic model). Of the estimates for b , the value obtained from the hydrodynamic model is likely closer to the true estuary value than that obtained from the field data due to the locations of the field samples (surface samples at the shoreline), and the uncertainty introduced by averaging these over the estuary.

Figure 6 shows predicted potential total nitrogen concentrations as a function of annual catchment nitrogen load for

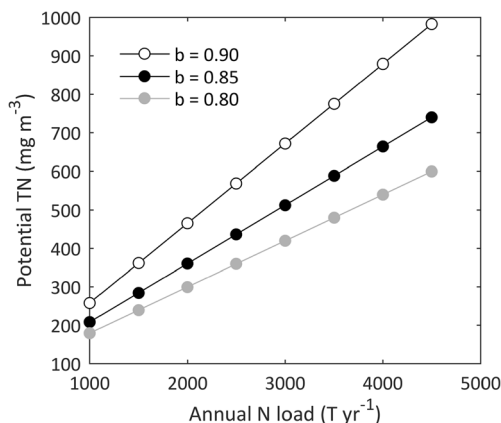

Fig. 6 Predicted estuary TN concentration vs annual nitrogen load for the New River Estuary under three specifications of the tuning parameter, *b*

tuning factors of 0.80, 0.85 and 0.90. An oceanic concentration of 70 mg m⁻³ is used (from annually averaged CARS values for this area). The annual nutrient loads from the catchment are converted to riverine nutrient concentrations by dividing by the mean annual flow. This simplification overlooks the fact that flows and concentrations are higher during winter than in summer, such that nutrient load to the estuary is larger during winter. However, CLUES currently provides only annual mean flows and nutrient loads. The predicted estuary potential concentrations were 524, 644 and 852 mg m⁻³ when setting the tuning parameter *b* to 0.80, 0.85 and 0.90 respectively.

Applying the same weighted-averaging scheme as used for salinity field samples to nutrient field data gives a weighed mean annual dissolved nitrogen concentration of 510 mg m⁻³, which is somewhat less than the prediction of 644 mg m⁻³ obtained for mean flow predictions using *b* = 0.85. The measured concentration is expected to be lower because the CLUES-estuary delivers ‘potential’ nutrient concentrations, and does not account for denitrification or nutrient uptake by primary producers.

Estuary Dilution and Flushing Times

Dilution factors were calculated for 415 New Zealand coastal hydrosystems contained in the Coastal Explorer database. A breakdown of which model provided the dilution value according to hydrosystem type (Hume et al. 2007) is shown in Fig. 7a. The Luketina model provided the dilution factor for the majority of estuaries, while ACEXR was used only for estuaries likely to be strongly stratified, such as fjords, some sounds, tidal river mouths and very few tidal river lagoons, coastal embayments or lagoons. All coastal lakes were assumed to be freshwater dominated. Some systems classified by Hume et al. (2007) as tidal river mouths and tidal river lagoons were likely, based on the large ratio of freshwater flow to tidal prism, to have no seawater inflow, with any apparent tidal range being due to backwater effects. These were also assigned *D* = 1. Many of these systems may be ICOEs, and the conservative assumption of no dilution (*D* = 1) was also appropriate for when these systems are closed. The simple tidal prism model was not used for any estuaries using the default values for flows, volume and tidal range obtained from CLUES and Coastal Explorer.

A similar breakdown according to the four types of estuary used within the NZ Estuarine Trophic Index (Robertson et al. 2016a) is given in Fig. 7b.

Mean dilution factors and flushing times for each hydrosystem type based on the classification of Hume et al. (2007) are given in Table 3. Note that mean dilution factors

have been calculated as harmonic mean values $\bar{D} = n$

$\left(\sum_{i=1}^n \frac{1}{D_i}\right)^{-1}$ which are more useful for estimating mean salinities of each hydrosystem type ($S/S_0 = 1 - 1/D$) than geometric means. Coastal lakes, tidal river lagoons and tidal river mouths generally have low dilution compared to coastal embayments, fjords and sounds. Tidal lagoons and barrier-enclosed lagoons have on average intermediate dilution values. This indicates that we might expect coastal lakes,

Fig. 7 Model used for each hydrosystem type classified according to **a** Hume et al. (2007) and the **b** New Zealand Estuary Trophic Index (Robertson et al. 2016a)

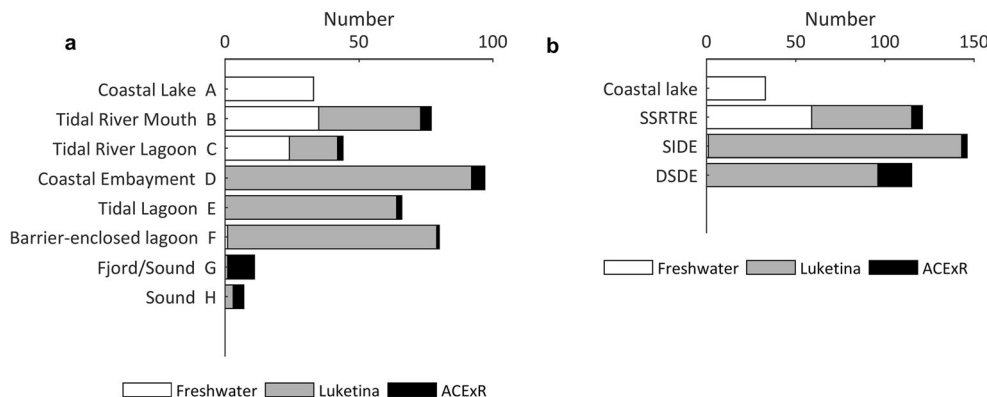

Table 3 Harmonic mean dilution factors and mean flushing time by hydrosystem type according to Hume et al. (2007)

Type	Hydrosystem name	Mean dilution	Mean flushing time (days)
A	Coastal lake	1	39.6
B	Tidal river mouth	1.33	0.57
C	Tidal river lagoon	1.35	1.09
D	Coastal embayment	12.9	22.3
E	Tidal lagoon	6.60	9.77
F	Barrier-enclosed lagoon	4.74	9.61
G	Fjord/Sound	36.1	16.4
H	Sound	148	24.7

tidal river mouths and tidal river lagoons to be much more sensitive to changes in nutrient loads than coastal embayments, fjords and sounds. Systems with long flushing time-scales are likely susceptible to phytoplankton growth (Ferreira et al. 2005), thus coastal lakes are expected to be highly susceptible to displaying eutrophic conditions in the form of suspended algae due to their long flushing times and low dilution. Tidal river mouths and river lagoons have low dilution but short flushing times, indicating that benthic macroalgae might dominate. In practice however, we have found that New Zealand tidal river mouths generally do not grow eutrophic levels of macroalgae because of other ecological factors, including deep depths and turbidity and hence low light (Robertson et al. 2016a).

Table 4 gives the harmonic mean dilution factors and mean flushing times according to NZ ETI type. Deep subtidal-dominated estuaries (DSDEs) have the highest dilution factors, while shallow short residence time river estuaries (SSRTREs) have low dilutions. Shallow intertidal-dominated estuaries (SIDEs) are intermediate in terms of dilution and flushing times. The residence times of intermittently open or closed states of both SSRTREs and SIDEs will vary greatly depending whether they are open or closed to the sea, a process not currently captured in the approach here. Residence times reported in Tables 3 and 4 are for estuaries in their open state. Intermittently open and closed estuaries are considered further in ‘Intermittently Closed Estuaries and Freshwater-Dominated Systems’ section.

Predicted dilution factors and flushing times for all 415 NZ coastal hydrosystems are mapped in Fig. 8. Clusters of systems with similar dilution factors and flushing times can be

seen. For example, the fjords along the South-West coast of the South Island generally have high dilutions (> 10) and long retention times (10–50 days), while the mid- to upper west-coast of the South Island has many river mouth systems that are predominately fresh water systems with low dilution ($D \sim 1$) and short residence times (< 1 day). On the east coast of both islands, systems generally have both low flushing times and dilutions (mostly river mouths), or high dilutions and moderate flushing times (coastal embayments and harbours), except for coastal lakes which have both low dilution and long residence times.

Distribution of Potential Nutrient Concentrations and Comparison to Observations

Nutrient loads from the CLUES GIS tool were used to estimate potential $\text{NO}_3\text{-N}$ and DRP for estuaries around New Zealand (Fig. 9a). A different colour scale is used for fresh-water systems (Fig. 9b) because the concentrations are higher in these systems. Observed mean $\text{NO}_3\text{-N}$ concentrations compiled for 40 estuaries derived from Dudley et al. (2016) are plotted in Fig. 9c. The observations include only a small subset of estuaries, but the spatial distributions of observed $\text{NO}_3\text{-N}$ are similar to those of potential $\text{NO}_3\text{-N}$. Estuaries on the south-west coast of the North Island have moderate-high potential and observed concentrations, while the large systems in the northern South Island have low potential and observed concentrations. There appears to be greater discrepancy between potential and observed concentrations towards the upper part of the North Island with lower observed concentrations than potential concentrations. Potential dissolved inorganic phosphorus concentrations (as dissolved reactive phosphorus, DRP) are plotted in Fig. 9d, e, with observed mean values in Fig. 9f. Predicted potential DRP concentrations are generally highest for the freshwater systems, which have low dilution. This is particularly the case for the east coast of the north island where all freshwater systems have predicted potential DRP > 100 mg m^{-3} . For estuarine systems, moderate (> 20 mg m^{-3}) to high (> 100 mg m^{-3}) potential DRP concentrations are predicted for mid-regions of the North Island, and moderate

Table 4 Harmonic mean dilution factors and mean flushing time by NZ ETI estuary type (Robertson et al. 2016a)

ETI Type	Mean dilution	Mean flushing time (days)
Coastal lake	1	39.6
SIDE	5.43	9.68
SSRTRE	1.34	0.76
DSDE	14.7	21.9

Fig. 8 **a** Dilution factors and **b** flushing time estimates for 415 New Zealand estuaries and coastal lakes. The sizes of the symbols are scaled by estuary volume. Round symbols are used for estuarine systems, and square for freshwater systems ($D = 1$)

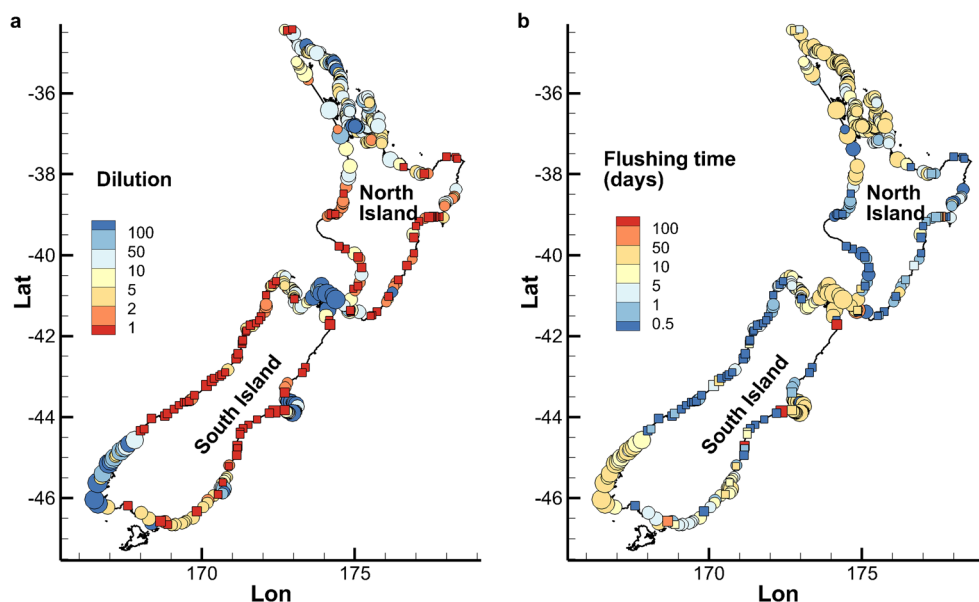

concentrations ($> 20 \text{ mg m}^{-3}$) for the estuaries on the south-east coast of the South Island. The fjords on the south-west of the South Island, sounds and embayments of the upper South Island and many of the systems in the upper North Island have low ($< 20 \text{ mg m}^{-3}$) potential DRP concentrations. In contrast, the observations show only five systems with DRP concentrations $> 20 \text{ mg m}^{-3}$.

Predicted potential $\text{NO}_3\text{-N}$ and DRP were compared with the observations of $\text{NO}_3\text{-N}$ and DRP collated from 40 estuaries sampled by regional and city councils (Fig. 10). Each point represents the average of all samples from all sites within each estuary. Sites located within rivers (i.e. upstream of the estuary) were excluded and no weighting of measured data to account for location or proportion of the estuary represented by each site was applied. Estuaries for which data from five or more sites were averaged are shown as solid circles, while those with four or less sampling sites are plotted as open circles. The dashed line shows where data would lie if there was a 1:1 relationship between observed and potential concentrations. However, we expect that observed concentrations will be less than potential concentrations due to non-conservative processes, thus the majority of the points should lie below the 1:1 line.

A linear regression through the solid circles which represent estuaries with five or more sampling sites (to reduce bias caused by sampling location) gave $\text{Measured} = 0.70 \times \text{Predicted} - 3.1$, $r = 0.73$, $P < 0.002$, showing a statistically significant relationship between predicted and observed $\text{NO}_3\text{-N}$. Potential DRP concentrations were not significantly correlated with observations. For those estuaries with five or more sampling sites, $r = 0.16$, $P > 0.57$. Most of the measured DRP concentrations were less than the potential DRP, as expected, but there were large outliers, including one estuary where measured DRP was an order of magnitude higher than predicted.

Discussion

Performance and Limitations of Dilution Modelling

The nation-wide prediction of estuarine potential $\text{NO}_3\text{-N}$ showed a positive and statistically significant relationship with observed $\text{NO}_3\text{-N}$ data, indicating that the combination of GIS-land use model and simple dilution models captures the influence of N loadings across a range of catchments and estuary types. As in other countries, N is almost always the limiting nutrient in New Zealand estuaries and coastal waters (Barr and Rees 2003; National Research Council 2000; Valiela et al. 1997). Nitrate is the dominant component of total dissolved N in the freshwater loads, with ammonium generally being in low concentration in New Zealand river waters (Larned et al. 2016). Thus, the predictions of potential $\text{NO}_3\text{-N}$ concentration should give useful indications of the eutrophic pressures on New Zealand estuaries. The slope of the linear regression between potential and observed $\text{NO}_3\text{-N}$ of 0.70 suggests about 30% of $\text{NO}_3\text{-N}$ was consumed by non-conservative processes, i.e. denitrification and uptake by algae. We are unsure of the causes of the relatively poor performance of the modelling for DRP but we suggest that it may be partly due to sampling sites mostly being located at the shoreline in shallow water where proximity to sediments and attendant biogeochemical processes of DRP sorption/desorption could influence P dynamics (Froelich 1988).

We believe that it is problematic to validate predictions of estuarine potential nutrient concentrations using field data, at least in the sense of expecting a 1:1 relationship between the two. Firstly, as previously noted, the model predicts a potential concentration that excludes the effects of denitrification and any uptake of nutrients by algae within the estuary. Measured (grab sampled) data on the other hand can be expected to

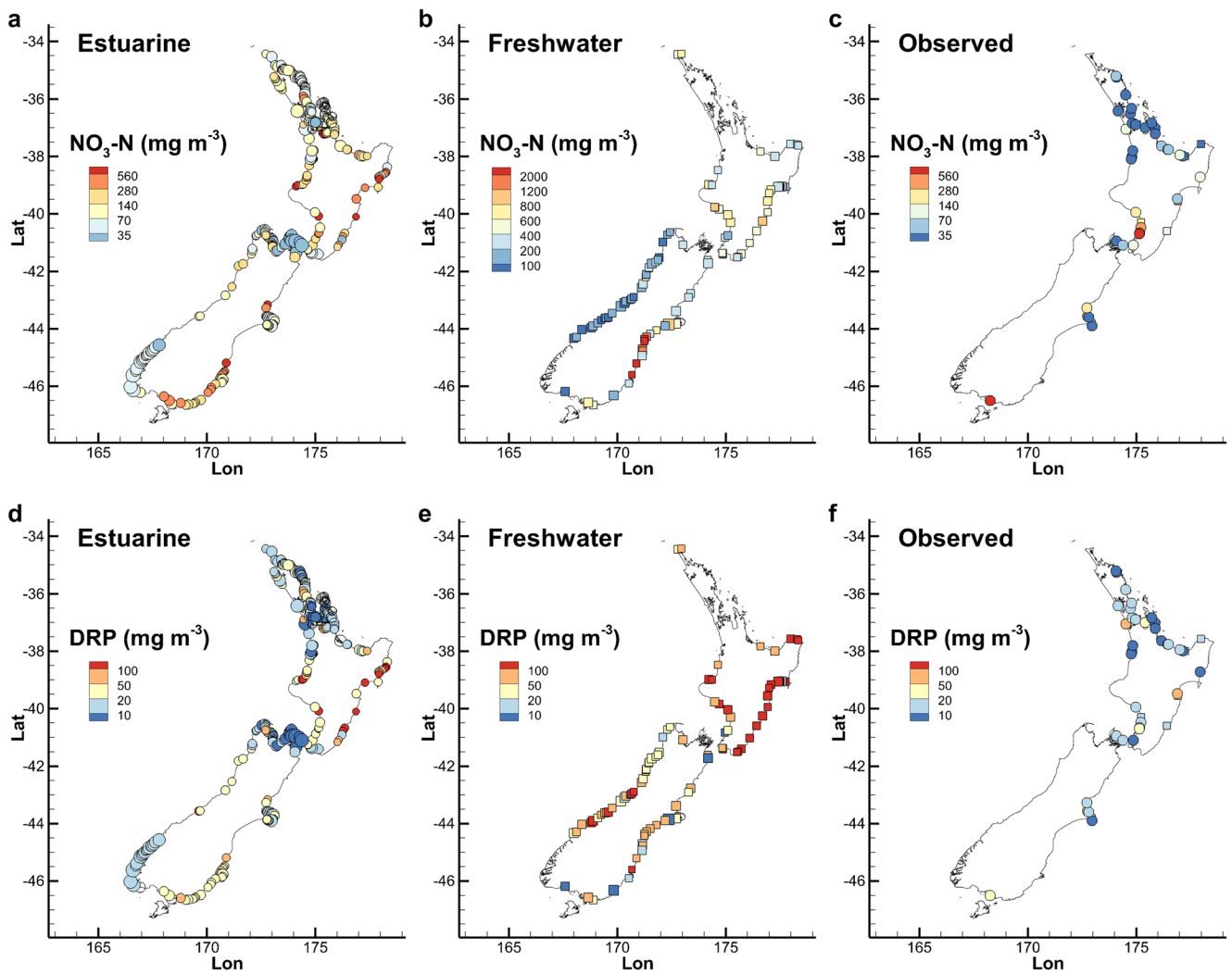
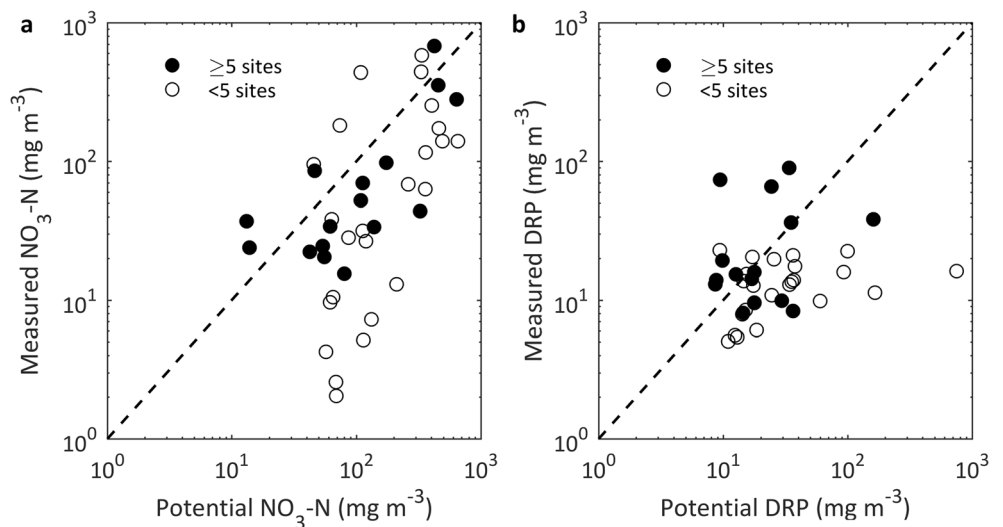

Fig. 9 Predicted potential nitrate ($\text{NO}_3\text{-N}$) concentrations in **a** estuarine systems, and **b** freshwater systems. Observed mean nitrate concentrations are plotted in **c**, with circles used for estuarine systems, and squares for systems identified as fresh-water dominated. Potential dissolved inorganic phosphorus (DRP) are shown for **d** estuarine and **e** freshwater systems, with observed mean DRP concentrations shown in **f**

Fig. 10 **a** Predicted potential $\text{NO}_3\text{-N}$ and **b** dissolved reactive phosphorus plotted against averaged measured data for 40 New Zealand estuaries. Estuaries where data were collected at five or more sampling sites are shown as solid circles



reflect in-situ concentrations which are affected by these processes. The potential concentrations could therefore be expected to be higher than measured concentrations. Secondly, the predictions are an estuary volume-averaged and time-averaged concentration. As described by Dudley et al. (2016), estuary nutrient sampling at most New Zealand estuaries consists of surface samples most often collected at the shoreline. In many estuaries, samples may be collected from only one or a small number of sites. In others, sampling stations may be targeted at mouths of rivers or other point sources. This makes it difficult to establish a truly representative estuary-averaged value from observations.

Our nation-wide predictions of potential nutrient concentration should be treated with caution as several possible error sources may reduce their accuracy. Nutrient load and flow data used in our nation-wide assessment have been obtained from the CLUES land use model (Elliott et al. 2016 and references therein) which does not yet simulate groundwater or effects of irrigation on river flows, or subsurface nutrient decay. Although the nutrient load models are calibrated to measured concentrations in rivers, lag effects from land-use intensification in some catchments may result in underestimation of ultimate loadings. The resolution and accuracy of the land-use within each catchment also influences the accuracy of the predictions (Elliott et al. 2016). Further compounding the issue, the estimates of estuary properties in the Coastal Explorer have been found to be inaccurate for some estuaries. This is due to the methods used to obtain these properties, but also because estuary properties may also change over time due to infilling, migration of bars and mouths and in some cases anthropogenic intervention. The data will be updated as better information is acquired, which will improve predictions in the future.

The major advantages of the dilution modelling approach developed here are that minimal input data are required, assessments can be made quickly and different nutrient load or flow scenarios can be easily compared. These are useful attributes for a regional or national screening tool. The combination of GIS-based land-use modelling combined with simple dilution models can identify estuaries where further ecological assessment should be made or where monitoring should be focussed. For example, no nutrient data are available for estuaries along the south-east coast of the South Island (Fig. 9c). Many of these have moderate to high potential $\text{NO}_3\text{-N}$ concentrations (Fig. 9a), but mostly short residence times (Fig. 8b) and consequently we expect that eutrophication would manifest mostly through macroalgae growth, with phytoplankton becoming a concern if any of those systems close to the sea (i.e. ICOEs).

A drawback to the dilution models is that they provide a single time- and volume-averaged estimate of potential nutrient concentration (and flushing time). However, for a great many estuaries in New Zealand, model-based predictions of

annual nutrient loads, such as from CLUES, are the only nutrient data available. Work is underway to seasonalise CLUES predictions. This will enable more accurate predictions for periods of concern such as summer periods when algal growth is likely to be nutrient limited. While the dilution models used here can easily be applied at different inflows, providing steady state solutions adequate for seasonal analysis, they should not be used as dynamic time-varying models. Volume-averaging is an issue because nutrient concentrations will vary spatially throughout an estuary. The locations where rivers enter the estuary, the shape of the estuary and position of the mouth will influence distributions of nutrients. Volume-averaged predictions of nutrient concentration and flushing time may fail to identify that parts of an estuary have higher-than-average nutrient levels that could drive macroalgal or phytoplankton blooms.

Similarly, high potential nutrient concentration and/or flushing time indicates only that an estuary is susceptible to eutrophication. Other factors control eutrophication (Hughes et al. 2011), for example a lack of suitable substrate or shallow areas for macroalgae to grow. More sophisticated approaches, such as 2D or 3D numerical modelling, can provide much greater detail on temporal and spatial variability in nutrient concentrations and identify possible eutrophication ‘hot spots’. Such modelling is computationally expensive and data intensive, and best suited for detailed studies of selected estuaries after they are identified by screening.

An intermediate approach is to replace simple dilution model-based predictions of dilution with relationships between river concentrations and estuary concentrations built from more rigorous assessments, for example computational models. These can be incorporated via look-up tables or equations developed for individual estuaries. Such approaches have been used to segment estuaries (Braunschweig et al. 2003; Choi and Lee 2004), or allow assessments of individual embayments modelled within a larger scale model (Abdelrhman 2005). Estuaries can also be modelled using interconnected box models (Hagy et al. 2000) which provides a degree of spatial variability. There are a small number of estuaries in New Zealand where either sufficient data have been gathered or for which hydrodynamic models have been developed, to enable calculation of spatially varying dilution factors. While the number of New Zealand estuaries for which dynamic models have been developed is small, they do tend to be ‘important’ systems (e.g. Kaipara Harbour, North Island, 36.4° S, 174.2° E). The simple estuary models can be replaced with more accurate predictions as these become available.

Intermittently Closed Estuaries and Freshwater-Dominated Systems

Our methods use a flow/tidal prism-based criterion to determine if a system is predominately freshwater. We have

assumed that salinity in these systems is negligible and that there is essentially no dilution by sea water. This is not likely to be true if there is an estuarine circulation when the mouth is open, or if there is significant wave overtopping. The no-dilution assumption we have used is deliberately conservative, providing a worst case, highest concentration scenario. An alternative approach for assessing eutrophication susceptibility of coastal lakes would be to use empirical models such as Vollenweider-type models (e.g. OECD 1982) which link algae to lake properties such as areal phosphorus loading, depth and residence time. Some estuaries have openings that vary in width over time. Currently, the only mechanism for considering the influence of these processes is via manually altering the tidal prism input in the dilution modelling.

Many estuaries, coastal lakes and lagoons have mouths that intermittently open and close to the sea (ICOEs). The determination of whether a system is an ICOE requires site-specific knowledge, and ICOEs are not clearly identified in the current version of Coastal Explorer. Consequently, these systems are poorly modelled at present. There are two options for assessing systems believed to be ICOEs. First, a worst-case condition can be estimated by manually setting the tidal prism to zero to obtain predictions of potential nutrient concentrations for when the mouth is closed. Alternatively, if there is knowledge of the typical length of mouth closure, then an estimate of the potential nutrient concentration obtained at the end of the closure period can be made as follows. If the closure period is long relative to the flushing time of the estuary in a closed state $T_{Fc} = (V + P)/Q_F$, then the closed ICOE can be modelled as a coastal lake with dilution tending to $D = 1$. For intermediate length closure periods, the potential concentration will increase towards that of the closed state, and may be estimated from

$$C(t_c) = C_{open} + (C_{closed} - C_{open})e^{-\frac{t_c}{T_{Fc}}}, \quad (10)$$

where C_{open} is the potential concentration of the estuary when open to the sea, $C_{closed} = C_R$ is the concentration when closed and t_c is the duration of the closure. In deriving Eq. 10, we assume that the estuary is fully mixed, that the freshwater inflow and the outflow from the estuary to the sea remain constant, there are negligible losses to evaporation or seepage and no sea water input from wave overtopping or seepage.

Management Applications of Dilution Modelling

An advantage of simple tools such as dilution modelling is the ease with which they can be made available to potential users. Several web-based tools built on simple estuary models have been made available including ASSETS (<http://www.eutro.org/>), OzCoast (<http://www.ozcoasts.gov.au/index.jsp>) and E-Estuary (https://ofmpub.epa.gov/rsig/rsigserver?edm/e_estuary.html). Some of these tools are developed for specific

regions, while others allow users to add their own estuary data. Provided the limitations of these tools are made clear, they provide useful information to inform and guide decision-makers. Our dilution models are available as part of the CLUES GIS application for New Zealand which is distributed to New Zealand local government and other users (Elliott et al. 2016). This combination of land-use and estuary dilution modelling enables users to vary land-use and examine consequent in-stream and in-estuary responses. Its graphical interface provides useful ‘data organising and display’ functionality by showing all river terminal reach loadings for each estuary in the database. Where such loadings enter a highly-indented segment of an estuary (with potentially low flushing), they may flag that area as requiring further investigation. Also, displays can include nutrient species breakdowns ($\text{NO}_3\text{-N}/\text{NH}_4\text{-N}/\text{DON}/\text{DRP}/\text{DOP}$). The models have also been applied through a web application as part of the New Zealand Estuary Trophic Index tools (Zeldis et al. 2017, <https://shiny.niwa.co.nz/Estuaries-Screening-Tool-1/>). This web application predicts dilution model outputs and eutrophication susceptibility based on the Coastal Explorer dataset, CLUES predictions of flows and nutrient loads and other physiographic information. Additional estuaries can readily be added, or estuary parameters can be altered to use more recent data or explore scenarios of land-use/loading. The ability to add other estuaries gives the potential to apply the dilution modelling approach described here in other countries. An important caveat is that the web-tool uses pre-calculated, estuary-specific, regressions between freshwater inflow and dilution when the ACEXR model is selected. These regressions are currently only supplied for estuaries in the NZ Coastal Explorer database. However, the NZ ETI tool also provides the option of using the ASSETS approach which gives a prediction of susceptibility but not concentration.

Summary and Conclusion

We have described an approach for predicting potential nutrient concentrations in estuaries using simple dilution models. These models require only a few basic parameters, making them easy to apply. They give a single time- and space-averaged concentration as a function of mean flow and nutrient input.

Using a GIS-based land-use model and a database of New Zealand estuaries, we have made predictions of potential nutrient concentrations and flushing times for most estuaries in New Zealand. Comparison with observations show that the predictions of potential $\text{NO}_3\text{-N}$ concentrations are significantly correlated with measured concentrations, although over-predict them as expected after consideration of non-conservative processes. Potential and measured DRP are not significantly correlated, although

again, as expected the potential concentrations are in most cases higher than measured. New Zealand estuarine systems are typically N limited, thus the relatively direct relationship between potential N concentrations and observed concentrations is perhaps not surprising. The discrepancy between potential phosphorus concentrations and observations suggests the existence of strong biotic or abiotic processes which are important in P cycling but not limited by P. Because New Zealand estuarine systems are typically N limited, the poor predictive performance for phosphorus is less critical.

While the dilution modelling approach is not expected to give predictions of a high accuracy, its value lies in offering screening for estuaries likely to be highly sensitive to current nutrient loads based on their physical attributes, and to test effects on nutrient concentrations of different loading/land-use scenarios.

Further work is currently underway to link the predicted potential nutrient concentrations with susceptibility of New Zealand estuaries to eutrophication, to provide a means of ‘scoring’ an estuary and predicting sensitivity to catchment land-use changes.

Acknowledgements This work was funded through the NIWA SSIF Catchment to Estuaries programme (FWCE1703/FWCE1803). Salinity and nutrient data used in this study were made available by Auckland Council, Bay of Plenty Regional Council, Environment Canterbury, Gisborne District Council, Greater Wellington Regional Council, Hawke’s Bay Regional Council, Horizons Regional Council, Invercargill City Council, Marlborough District Council, Northland Regional Council and Waikato Regional Council. Thanks also to the Associate Editor and two anonymous reviewers for their helpful comments and suggestions.

Open Access This article is distributed under the terms of the Creative Commons Attribution 4.0 International License (<http://creativecommons.org/licenses/by/4.0/>), which permits unrestricted use, distribution, and reproduction in any medium, provided you give appropriate credit to the original author(s) and the source, provide a link to the Creative Commons license, and indicate if changes were made.

References

- Abdelrhman, M.A. 2005. Simplified modeling of flushing and residence times in 42 embayments in New England, USA, with special attention to Greenwich Bay, Rhode Island. *Estuarine, Coastal and Shelf Science* 62 (1-2): 339–351.
- Abdelrhman, M.A. 2007. Embayment characteristic time and biology via tidal prism model. *Estuarine, Coastal and Shelf Science* 74 (4): 742–755.
- Barr, N.G., and T.A.V. Rees. 2003. Nitrogen status and metabolism in the green seaweed *Enteromorpha intestinalis*: An examination of three natural populations. *Marine Ecology Progress Series* 249: 133–144.
- del Barrio, P., N.K. Ganju, A.L. Aretxabaleta, M. Hayn, A. Garcia, and R.W. Howarth. 2014. Modeling future scenarios of light attenuation and potential seagrass success in a eutrophic estuary. *Estuarine, Coastal and Shelf Science* 149: 13–23.
- Borja, A., S.B. Bricker, D.M. Dauer, N.T. Demetriades, J.G. Ferreira, A.T. Forbes, P. Hutchings, X. Jia, R. Kenchington, J.C. Marques, and C. Zhu. 2008. Overview of integrative tools and methods in assessing ecological integrity in estuarine and coastal systems worldwide. *Marine Pollution Bulletin* 56 (9): 1519–1537.
- Braunschweig, F., F. Martins, P. Chambel, and R. Neves. 2003. A methodology to estimate renewal time scales in estuaries: the Tagus estuary case. *Ocean Dynamics* 53 (3): 137–145.
- Bricker, S.B., C.G. Clement, D.E. Pirhalla, S.P. Orlando, and D.R.G. Farrow. 1999. *National Estuarine Eutrophication Assessment: effects of nutrient enrichment in the nation's estuaries*, 71. Silver Spring, MD: NOAA, National Ocean Service, Special Projects Office, and the National Centers for Coastal Ocean Science.
- Bricker, S.B., J.G. Ferreira, and T. Simas. 2003. An integrated methodology for assessment of estuarine trophic status. *Ecological Modelling* 169 (1): 39–60.
- Cerco, C.F., and M.R. Noel. 2013. Twenty-one-year simulation of Chesapeake Bay water quality using the CE-QUAL-ICM eutrophication model. *JAWRA Journal of the American Water Resources Association* 49: 1119–1133.
- Choi, K.W., and J.H.W. Lee. 2004. Numerical determination of flushing time for stratified water bodies. *Journal of Marine Systems* 50 (3-4): 263–281.
- CSIRO. 2011. CSIRO atlas of regional seas (CARS).
- Dudley, B., O. Burge, M. Unwin, D. Booker, and J. Zeldis. 2016. *Analysis of New Zealand coastal water quality. NIWA client report CHC2016-072, 47*. Christchurch: Prepared for Ministry for the Environment <https://www.mfe.govt.nz/publications/environmental-reporting/new-zealand-coastal-water-quality-assessment>.
- Dyer, K.R. 1973. *Estuaries: A Physical Introduction*. London: John Wiley and Sons.
- Elliott, A.H., A.F. Semadeni-Davies, U. Shankar, J.R. Zeldis, D.M. Wheeler, D.R. Plew, G.J. Rys, and S.R. Harris. 2016. A national-scale GIS-based system for modelling impacts of land use on water quality. *Environmental Modelling & Software* 86: 131–144.
- Ferreira, J.G., W.J. Wolff, T.C. Simas, and S.B. Bricker. 2005. Does biodiversity of estuarine phytoplankton depend on hydrology? *Ecological Modelling* 187 (4): 513–523.
- Fox, S.E., E. Stieve, I. Valiela, J. Hauxwell, and J. McClelland. 2008. Macrophyte abundance in Waquoit Bay: effects of land-derived nitrogen loads on seasonal and multi-year biomass patterns. *Estuaries and Coasts* 31 (3): 532–541.
- Froelich, P.N. 1988. Kinetic control of dissolved phosphate in natural rivers and estuaries: a primer on the phosphate buffer mechanism I. *Limnology and Oceanography* 33: 649–668.
- Ganju, N.K., M.J. Brush, B. Rashleigh, A.L. Aretxabaleta, P. del Barrio, J.S. Grear, L.A. Harris, S.J. Lake, G. McCardell, J. O’Donnell, D.K. Ralston, R.P. Signell, J.M. Testa, and J.M.P. Vaudrey. 2016. Progress and challenges in coupled hydrodynamic-ecological estuarine modeling. *Estuaries and Coasts* 39 (2): 311–332.
- Gillibrand, P.A., M.E. Inall, E. Portilla, and P. Tett. 2013. A box model of the seasonal exchange and mixing in regions of restricted exchange: application to two contrasting Scottish inlets. *Environmental Modelling & Software* 43: 144–159.
- Hagy, J.D., W.R. Boynton, and L.P. Sanford. 2000. Estimation of net physical transport and hydraulic residence times for a coastal plain estuary using box models. *Estuaries* 23 (3): 328–340.
- Hughes, B.B., J.C. Haskins, K. Wasson, and E. Watson. 2011. Identifying factors that influence expression of eutrophication in a central California estuary. *Marine Ecology Progress Series* 439: 31–43.
- Hume, T.M., T. Snelder, M. Weatherhead, and R. Lifting. 2007. A controlling factor approach to estuary classification. *Ocean & Coastal Management* 50 (11-12): 905–929.
- Hume, T., P. Gerbeaux, D. Hart, H. Kettles, and D. Neale. 2016. *A classification of New Zealand's coastal hydrosystems*, 120. Hamilton:

- Ministry of the Environment <http://www.mfe.govt.nz/publications/marine/classification-of-new-zealands-coastal-hydrosystems>.
- Kirk, R.M., and G.A. Lauder. 2000. *Significant coastal lagoon systems in the South Island, New Zealand: coastal processes and lagoon mouth closure*, Science for conservation. Vol. 47. Wellington: Department of Conservation.
- Larned, S.T., T. Snelder, M.J. Unwin, and G.B. McBride. 2016. Water quality in New Zealand rivers: current state and trends. *New Zealand Journal of Marine and Freshwater Research* 50 (3): 389–417.
- Luketina, D. 1998. Simple tidal prism models revisited. *Estuarine, Coastal and Shelf Science* 46 (1): 77–84.
- Monsen, N.E., J.E. Cloern, and L.V. Lucas. 2002. A comment on the use of flushing time, residence time, and age as transport time scales. *Limnology and Oceanography* 47 (5): 1545–1553.
- National Research Council. 2000. *Clean coastal waters: understanding and reducing the effects of nutrient pollution*, 405. Washington, DC: National Academy Press.
- OECD (Organisation for Economic Cooperation and Development). 1982. *Eutrophication of waters. Monitoring, assessment and control*, 154. Paris: OECD.
- Plew, D., B. Dudley, and J. Bind. 2017. Canterbury region estuary eutrophication susceptibility assessment. NIWA Client Report, 26: Prepared for Environment Canterbury <https://api.ecan.govt.nz/TrimPublicAPI/documents/download/3208268>.
- Roberts, A.H.C., and N. Watkins. 2014. One nutrient budget to rule them all—the OVERSEER® best practice data input standards. In *Nutrient Management for the Farm, Catchment and Community, Occasional Report No. 27*, ed. L.D. Currie and C.L. Christensen. Palmerston North: Fertilizer and Lime Research Centre, Massey University.
- Robertson, B.M., L. Stevens, B. Robertson, J. Zeldis, M. Green, A. Madarasz-Smith, D. Plew, R. Storey, T. Hume, and M. Oliver. 2016a. NZ estuary trophic index screening tool 1. Determining eutrophication susceptibility using physical and nutrient load data. Prepared for Environlink tools project: Estuarine trophic index, 47: MBIE/NIWA contract no: C01X1420 <http://envirolink.govt.nz/assets/Envirolink-reports/R10-120NZ20Estuary20trophic20index20Screening20Tool20120-20Determining20eutrophication20susceptibility20using20physical20and20nutrient20load20data.PDF>.
- Robertson, B.M., L. Stevens, B. Robertson, J. Zeldis, M. Green, A. Madarasz-Smith, D. Plew, R. Storey, and M. Oliver. 2016b. NZ Estuary Trophic Index Screen Tool 2. Determining monitoring indicators and assessing estuary trophic state. Prepared for Environlink Tools Project: Estuarine Trophic Index, 68: MBIE/NIWA Contract No: COX1420.
- Rosen, M.R., R.R. Reeves, S. Green, B. Clothier, and N. Ironside. 2004. Prediction of groundwater nitrate contamination after closure of an unlined sheep feedlot. *Vadose Zone Journal* 3 (3): 990–1006.
- Sanderson, B.G., and G. Coade. 2010. Scaling the potential for eutrophication and ecosystem state in lagoons. *Environmental Modelling & Software* 25 (6): 724–736.
- Sandford, L.P., W.C. Boicourt, and S.R. Rives. 1992. Model for estimating tidal flushing of small embayments. *Journal of Waterway, Port, Coastal and Ocean Engineering* 118 (6): 635–654.
- Schwarz, G.E., A.B. Hoos, R.B. Alexander, and R.A. Smith. 2006. *The SPARROW Surface Water-Quality Model – Theory, Application, and User Documentation. U.S. Geological Survey Techniques and Methods, Book 6, Section B. Chapter 3*. Reston: USGS.
- Sheldon, J.E., and M. Alber. 2002. A comparison of residence time calculations using simple compartment models of the Altamaha River estuary, Georgia. *Estuaries* 25 (6): 1304–1317.
- Shepherd, M., and D. Wheeler. 2013. How nitrogen is accounted for in OVERSEER® Nutrient Budgets. In *Accurate and efficient use of nutrients on farms. Occasional Report No. 26*, ed. L.D. Currie and C.L. Christensen. Palmerston North: Fertilizer and Lime Research Centre, Massey University.
- Shepherd, M., D. Wheeler, D. Selbie, L. Buckthought, and M. Freeman. 2013. OVERSEER®: Accuracy, precision, error and uncertainty. In *Accurate and efficient use of nutrients on farms. Occasional Report No. 26*, ed. L.D. Currie and C.L. Christensen. Palmerston North: Fertilizer and Lime Research Centre, Massey University.
- Testa, J.M., D.C. Brady, D.M. Di Toro, W.R. Boynton, J.C. Cornwell, and W.M. Kemp. 2013. Sediment flux modeling: simulating nitrogen, phosphorus, and silica cycles. *Estuarine, Coastal and Shelf Science* 131: 245–263.
- Unwin, M., T. Snelder, D.J. Booker, D. Ballantine, and J. Lessard. 2010. Modelling water quality in New Zealand rivers from catchment-scale physical, hydrological and land-cover descriptors using random forest models. Prepared for Ministry for the Environment.
- Valiela, I., J. McClelland, J. Hauxwell, P.J. Behr, D. Hersh, and K. Foreman. 1997. Macroalgal blooms in shallow estuaries: controls and ecophysiological and ecosystem consequences. *Limnology and Oceanography* 42 (5part2): 1105–1118.
- Wheeler, D., M. Shepherd, M. Freeman, and D. Selbie. 2014. OVERSEER® nutrient budgets: selecting appropriate timescales for inputting farm management and climate information. In *Nutrient Management for the Farm, Catchment and Community, Occasional Report No. 27*, ed. L.D. Currie and C.L. Christensen. Palmerston North: Fertilizer and Lime Research Centre, Massey University.
- Whitall, D., S. Bricker, J. Ferreira, A.M. Nobre, T. Simas, and M. Silva. 2007. Assessment of eutrophication in estuaries: pressure–state–response and nitrogen source apportionment. *Environmental Management* 40 (4): 678–690.
- Zeldis, J., D. Plew, A. Whitehead, A. Madarasz-Smith, M. Oliver, L. Stevens, B. Robertson, O. Burge, and B. Dudley. 2017. The New Zealand estuary trophic index (ETI) tools: Tool 1—determining eutrophication susceptibility using physical and nutrient load data: Ministry of Business, Innovation and Employment Environlink tools: C01X1420.