



Drilling and Grouting Works for Pressurised Groundwater Conditions of the Semmering Base Tunnel

Helmut Wannemacher · Manuel Entfellner · Hannes Hauer

Received: 11 February 2022 / Accepted: 26 April 2022 / Published online: 8 June 2022
© The Author(s) 2022

Abstract The Semmering Base Tunnel (SBT), with a total length of 27.3 km, is one of the leading construction projects of the Baltic-Adriatic Railway Network. The tunnel connects the two federal provinces of Lower Austria and Styria and cuts through the eastern part of the Alps. The construction lot SBT 1.1-Tunnel Gloggnitz is characterized by a complex geological- and hydro-geological architecture containing alternating competent geological structures, major fault zones, and corresponding geological transition zones. There are three main water-bearing formations at the construction lot SBT 1.1: (a) Karst-prone blocky limestone with an initial water pressure of 10 bar. The discontinuities form a highly permeable interconnected joint network with a significant storage coefficient of the groundwater table. (b) Massive to blocky dolomite with an initial water pressure of 25 bar. The systematic discontinuities and disturbed zones of subsidiary structures with karst form a permeable, interconnected joint network. (c) The

transition zone of the limestone to base structure marks the most challenging area for consolidation- and sealing grouting. Weak fault rocks characterize transition zones with intense fracturing. However, as subjected to high groundwater pressure of 10 bar, these zones are associated with the potential of flowing ground conditions. Based on the overall project requirements, specific drilling- and grouting methods and materials for pre-excitation grouting have been established and successfully implemented in the construction process. The innovations include a Standpipe-Packer substituting a conventional steel standpipe, a specifically cased drilling system with grouting inserts to prevent erosion within the borehole and allow for defined grouting. In addition, this Grouting-Pipe system replaces standard tube-à-manchettes and controls the flushing while drilling with preventers. Finally, a combined cement-polyurethane grout mix (Hybrid Grout) was implemented to stabilize the grout. The implementation of these measures will be discussed in detail, and their benefits to the construction process will be highlighted.

All authors contributed equally to this work.

H. Wannemacher (✉) · M. Entfellner · H. Hauer
Implenia Austria GmbH, Salzburg, Austria
e-mail: Helmut.Wannemacher@implenia.com

H. Wannemacher
RWTH - Aachen, LIH, Aachen, Germany

M. Entfellner
Institute of Rock Mechanics and Tunnelling, Graz
University of Technology, Graz, Austria

Keywords Semmering base tunnel · High-pressure grouting · Pre-excitation grouting · Hybrid grouting

1 Introduction

The Semmering Base Tunnel (SBT), with 27.3 km, will relieve the historical Semmering railway

section, running through the foothills of the Eastern Alps. The SBT is part of the transnational Baltic-Adriatic Railway Axis, connecting Lower Austria and Styria in Austria (Gobiet and Wagner 2011).

The project is located within an environmental protection area, including spring reserves for the adjacent cities. Therefore, the excavation faces constraints towards tolerable water inflow to the tunnel. The excavation of the limestone/dolomite sections and adjacent fault zones with a total length of approximately 3.0 km for the two tubes with high groundwater tables in the central part of the tunnel mark the main challenge for the grouting works. The rocks withhold a prestigious persistent fracture network, occasionally with karst at a depth of the tunnel alignment. The works feature continuous pre-excavation grouting to decrease the permeability, first to an acceptable level for the excavation, and secondarily to seal remaining local spots of water ingress to comply with environmental restrictions in the long term. The essence of pre-excavation grouting in tunneling relies on low-frictional interaction with the grouting works, emphasizing reducing downtimes related to the grouting process.

Grouting works facing high groundwater heads demand protective sealing of boreholes with preventers and the usage of stable grout mixes to limit wash-out effects and reduce the setting time upon filling fractures. Additional challenges are related to the drilling technique, especially of erosional

geological features as part of fault zones subjected to the high groundwater pressure.

2 Site Description and Geological Overview

The lot SBT 1.1-Tunnel Gloggnitz, as the easternmost part of the Semmering Base Tunnel, involves the construction of two single-track tunnels with an excavation profile of 80 m². The entire tunnel length is approximately 7.4 km and includes 16 cross passages. The tunnel works include two attacks. First, the northern tunnel drive is excavated from Gloggnitz towards the south, whereas the southern sections are excavated from the intermediate construction access Göstritz (see Fig. 1) (Entfellner et al. 2021). The southern part consists of the 1.2 km long Göstritz access tunnel, two 250 m deep shafts, and the adjacent caverns (Wieland et al. 2018). Current tunneling works towards Gloggnitz (north), and towards Mürzzuschlag/contract SBT 2.1-Tunnel Fröschnitzgraben (south) are executed using conventional excavation (mechanical excavator and drill and blast method) (Wagner et al. 2015).

The SBT 1.1-Tunnel Gloggnitz section crosses three large tectonic units of the Eastern Alps (see Fig. 2). The entire area is tectonically highly deformed, resulting in a complex geological nappe and fold architecture. The north-eastern part of the tunnel (Portal-Gloggnitz) consists of highly fractured metasedimentary rocks of the greywacke zone.

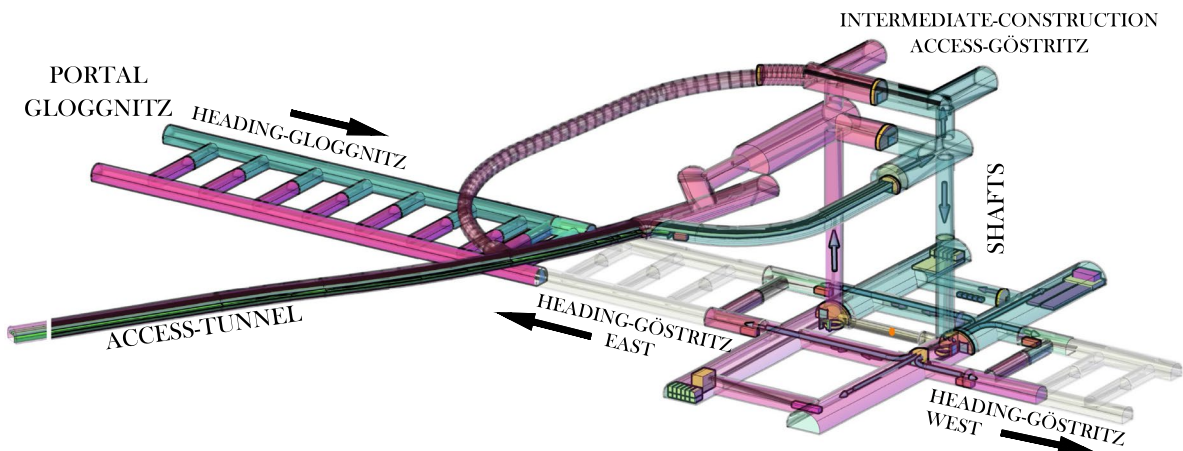

Fig. 1 Overview of the lot SBT 1.1 with the tunnel heading Gloggnitz and the intermediate construction access Göstritz. The colored areas represent the excavated sections at the beginning of 2022

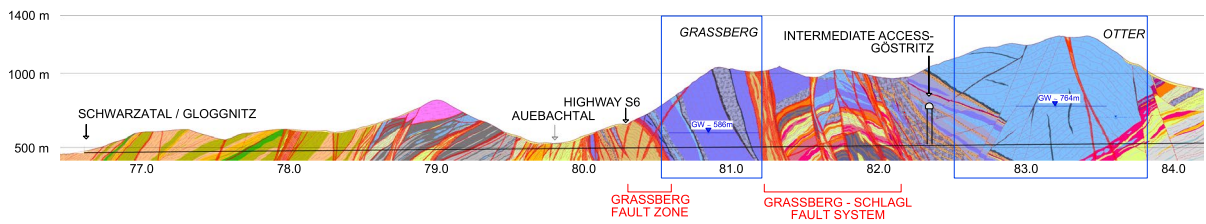

Fig. 2 Geological longitudinal section of contract SBT 1.1-Tunnel Gloggnitz

In the area of the intermediate construction access Göstritz, carbonatic and siliceous rocks of the central Permozoic (Semmering-Unit) prevail. Finally, the southeastern-most tunnel section at the boundary to the lot SBT 2.1 comprises crystalline rocks (Wechsel-Crystalline).

The water-bearing dolomite of the *Otter* (see Fig. 2/blue section right) with a total length of 800 m per track is characterized by a massive to blocky appearance with a distinct fracture network at a pressure level of 25 bar. In addition, singular karst and highly permeable interconnected joints occur (see Fig. 3/middle). The main challenge for the grouting operation is the integration of the intermittent grouting works within the tunnel excavation works, the reduction of the setting time, and the limitation and dissipation of grout spread. The headings in the water-bearing Otter structures are close to completion.

The water-bearing limestone of the *Grasberg* (see Fig. 2/blue central section) with a total length of 700 m per track is characterized by a blocky structure

with a persistent fracture network and the appearance of local karst features (see Fig. 3/left).

Hydraulic in-situ tests during the tunneling works affirm the anticipated high conductivity up to $k_f = 6 \times 10^{-4}$ m/s with a significant storage coefficient of the groundwater table. This zone is excavated from the portal Gloggnitz (Wagner et al. 2015).

The impermeable *Grasberg Fault Zone* delaminates the schists towards the water-bearing limestone of the *Grasberg* (see Fig. 2/left edge of the blue central section). The core of the fault zone is approximately 50 m wide in the tunnel axis and consists of overconsolidated fault rocks (cataclasite of mica schists) and disturbed high permeable carbonatic breccia (see Fig. 3/right). The groundwater pressure is 10 bar in the carbonatic breccia. The excavation of the transition zone formed by non-permeable but highly erodible schists to the high-permeable carbonatic breccia remains one of the highest challenges for grouting. One of the challenges is the complete leakage control during drilling to avoid irrigation of the

Fig. 3 Drilling core of Grasberg-limestone with karst (left), drilling core from weakness zone of Otter-dolomite with polyurethane grout (middle), and a sample of a carbonatic breccia from the transition zone with cement grout (right)



erodible schists, potentially leading to flowing ground conditions (Holzer et al. 2020).

Continuous pre-excitation grouting is foreseen with an innovative casing system (see Sect. 3.2) to control water inflow and erosion by decreasing the permeability to a target level of 5 Lugeon. However, groundwater lowering is not allowed due to environmental constraints (GZ. 2015; Gobiet and Nipitsch 2015). Furthermore, even temporary reduction is not applicable due to the high storage coefficient of the geological formations.

3 The Construction Process of Pre-Excavation Grouting

Continuous pre-excitation grouting as a part of the tunnel requires a complete integration of the grouting process within the standard tunneling works. The main challenge relates to harmonising the two different operations, requiring various equipment and training of the personnel. Transportable grouting equipment has proven effective and adaptive to conceivable changing conditions. However, the studies of the grouting work as part of the tunnel excavation sequence have shown that the highest time impact relates to the curing time of the standpipes and the likely grout dilution processes facing large fractures and structures with high water pressure. The primary sources of downtime and erosion risk while drilling combined with variable hydro-geological conditions gave reason for developing special risk-mitigating measures.

Both methods can be used independently from the acting water pressure. However, in massive rock mass, the Top-Hammer System (see Sect. 3.1) and for weak erosive rock mass (highly fractured/fault zones), the Grouting-Pipe System (see Sect. 3.2) is foreseen. The system selection is determined in

advance based on the findings of the exploration boreholes accompanying the tunneling works. Until the beginning of 2022, 55 of 115 pre-excitation grouting rounds with the top-hammer system and 5 of 26 pre-excitation grouting rounds with the grouting-pipe system have been carried out. Roughly 3.000 m tunnel (141 rounds) will demand rock mass sealing.

3.1 Top-Hammer System (open borehole)

The so-called *Top-Hammer System* is used within massive to blocky rock mass conditions, with no potential for erosion. Such circumstances favor using a rotary-percussive top-hammer drilling method to establish an open borehole for the grouting operation. The drilling system adopts a drill jumbo with two adapted drill rigs and top-hammers, a standpipe-packer with preventer (see Sect. 4.1), and a specialized tube drill pipe (see Fig. 5).

The tubular drill rod withholds an identical cross-section throughout (also at the coupling). It thus facilitates continuous preventer controlled protection while drilling, avoiding potential sudden water inrush from larger karstic voids of all boreholes.

The standard grouting layout consists of 30 boreholes with a drill diameter of 76 mm and a rod diameter of 50 mm. The maximum length of a borehole is 30 m. The maximum inclination is 7° from the horizontal (see Fig. 4). The overlap of the individual pre-grouting rounds in the longitudinal direction of the tunnel is approximately 6 m (see Fig. 4, longitudinal section). All holes are drilled from the regular tunnel cross-section, requiring no enlargement. The intermittent drilling and grouting sequence is divided into six stages. After the borehole has reached the intended final depth, the drill rod is pushed back under the protection of the preventer. The water inflow rate is measured directly with discharge tests at the borehole, while the

Fig. 4 Pre-excitation drilling- and grouting layout for the top-hammer system with a cross-section (left) and longitudinal section (right) (ÖBB-Infrastruktur AG 2022)



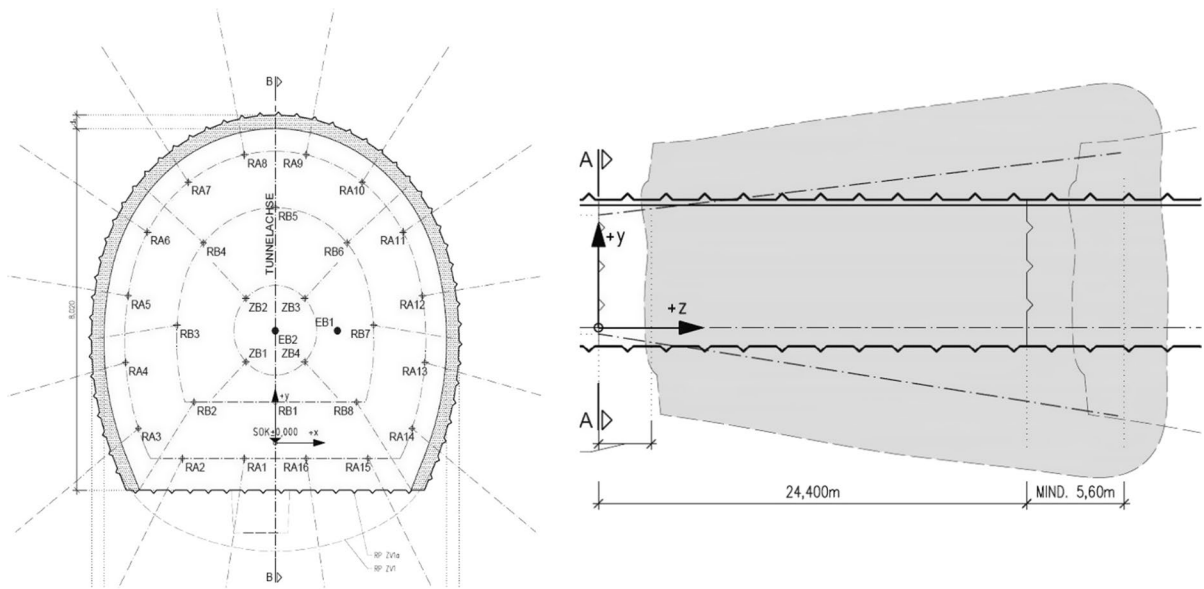

Fig. 5 Drill bit (76 mm diameter) with tube pipe for preventer protective drilling

pressure at rest is measured at a valve pre-installed at the packer. Minor water ingress (≤ 5 l/s) allows installing a lost packer behind the standpipe-packer.

Otherwise, the shut-off device is closed, and grouting is performed directly via the bypass of the preventer, prolonging the grouting section. In this case, grouting is carried out from the borehole mouth. However, both methods demand the usage of a stable grout mix (see Sect. 4.2). In addition, the open borehole system enables high flow rates of the grout material (approximately up to 30 l/min), reducing the grouting time. Hydraulic borehole tests after the first drilling series determine the permeability and define the grouting material (cement, micro-cement, hybrid grout, acrylate gel, silicate gel, polyurethane). In the last phase, hydraulic borehole tests (Lugeon tests) define the achieved sealing grade by grouting.

3.2 Grouting-Pipe System (cased borehole)

Brittle shear zones form the contact zones of limestone to adjacent lithologies. The shear zones consist of fines with various consolidation grades of soil-like structures. The boreholes bridge these sensitive erosive zones and allow sealing of neighboring water-bearing zones before excavation. Innovative *Grouting-Pipe Systems* are used within these erodible rock mass conditions. The grouting pipe is utilised as a casing while drilling and remains in the ground as a support element to preclude borehole failure. The grouting pipe is installed with a rotary-percussive top-hammer drilling method. The drilling system consists of the drill jumbo with two drill rigs and top-hammers, a conventional steel standpipe with a preventer, and the grouting pipe (see Fig. 6). The tubular steel pipe is adapted from the pipe-umbrella system (or canopy tube method) and equipped with

Fig. 6 Grouting-pipe system with a sealable drill bit, steel pipe with grouting inserts (self-sealable valves), and inner drill rod

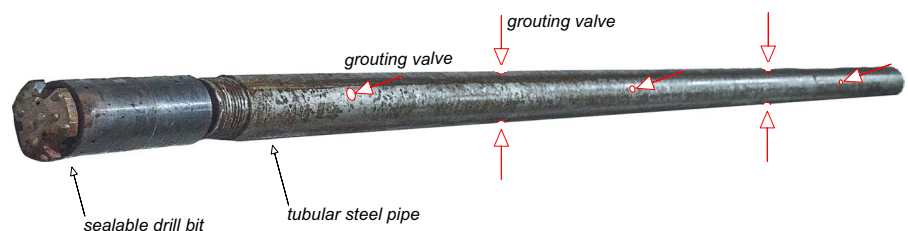

special systematically spaced grouting inserts (self-sealable valves) and sealable drill bits. The grouting pipe serves as a casing and flushing path and a water-retaining medium during the drilling and grouting process. It overcomes the limitations of the installation of the classical tube-à-manchettes. Since the grouting pipe remains in the ground, various crucial operational steps dispense (Wannenmacher et al. 2017b), preventing undesired water- and material inflows during all operation processes from drilling until grouting is started. In addition, the reduction to only one potential flow path (annulus gap) enables the application of standard preventer systems.

The standard drilling layout (see Fig. 4) consists of 34 boreholes with 24 m. The drilling diameter is 102 mm, while the pipe diameter is 89 mm, resulting in a theoretical annulus gap of 6.5 mm. The wall thickness of the steel pipe is 8 mm. The overlap of the individual pre-excavation grouting rounds is limited to 10 m in the longitudinal direction of the tunnel. The minimum stretch is required to relieve the hydraulic gradient towards the tunnel face. Conventional steel standpipes between 3 and 6 m are used to transfer the water pressure forces (up to 25 bar) into the rock mass and prevent erosion along the anchoring length. All grouting pipes are drilled from the regular tunnel cross-section with preventer protection. Upon drilling, the drill bit with a non-return valve seals the main flow path for flushing with a mechanical lock, and the inner drill rod is pushed back. However, the mounted preventer still seals the flow path of the annulus gap between rock mass and grouting pipe.

Grouting is performed in two stages. In the first step, a single-packer at the bottom of the grouting pipe is installed to grout through the drill bit ahead of the borehole. Then, the sectional grouting is carried out along the grouting pipe with a double-packer. The

self-locking grouting inserts are located at a distance of 0.5 m (two opposite inserts) and twisted alternately by 90° at the next position (see Fig. 7). Depending on the hydro-geological conditions, double-packers with free grouting lengths between 0.6 m and 3.0 m are used. The confinement of the injection valves' outlet obeys suspension usage with a higher viscosity, typically attributed to polyurethane or even combined cement-polyurethane grout mixes. Typically these grouting materials tend to fill the dead storage of the double packer, leading to a progressive reduction of the sectional flow area and blockage over a short time.

Consequently, the small inserts allow only low viscosity grouting materials and minor flow rates (approximately 1–5 l/min). Therefore, especially in weak ground conditions, the observations of the stop criteria are essential to avoid jacking the ground (Wannenmacher et al. 2019).

4 Innovative Developments for Grouting of High Permeable Ground Conditions

4.1 Development of a Mechanical Standpipe-Packer

Standpipes are required in unstable rock mass conditions to transfer loads into the rock mass, direct the boreholes, and host preventers to control the drilling operations. In addition, within soluble ground conditions, the standpipe prevents erosion within the area of the borehole mouth.

The requirements for the drilling within stable rock mass conditions foresee a temporary sealing of the borehole and discharge of the ingressing water while drilling through water-bearing zones. Furthermore, the favorable ground conditions of the *Otter* and *Grasberg* favor a mechanical solution of retractable

Fig. 7 Grouting inserts (self-sealable valves) installed in a grouting pipe (middle) and removed grouting inserts (bottom of the valve, left/top of the valve, right)



and reusable standpipe-packers instead of standard single-use steel standpipes (see Fig. 8).

The standpipe packer relies on the principle of standard mechanical packers used for grouting open boreholes. The packer is equipped with various plastic rings, with a shore hardness from 40 to 75 (according to the ASTM D2240 (ASTM 2010)) mounted on an inner steel pipe with an internal diameter of 80 mm and wall thickness of 10 mm. The standpipe allows for the usage of drill bits up to 76 mm. Furthermore, the standpipe hosts a quick coupling to mount a preventer. The optimized setup allows drilling with a top-hammer and a tube drill pipe under high water heads and subsequent grouting, with less effort for installation of preventive measures, with no reduction of safety. An additional smaller packer can be inserted into the standpipe packer, or even a coupling allows for direct mounting. The larger cross-section favors high viscosity grout mixes to avoid filtration in the water-saturated borehole. The combined cement-polyurethane grout mix could control the filtration during the borehole filling.

However, the prerequisites for the optimized system are favorable, non-erosive geological conditions that allow for the percussive drilling of a borehole with a diameter of 152 mm of about 1.2 m length and to brace the standpipe-packer against the borehole

walls. Unguided drilling of the standpipe's borehole showed a rapid descent of drilling, requiring a prolongation of the reaming bit with a drilling shoe to provide necessary straightness (see Fig. 9).

However, the free tensioning length of the standpipe-packer of 750–1200 mm allows for compensating for certain imperfections of the borehole walls caused by drilling or geological flaws. The rig of the drill jumbo clamps and unclamps the packer without additional manipulation, increasing installation efficiency (see Fig. 10). The standpipe is pre-stressed with a load of 45 kN to withstand the overall water pressure of 25 bar. The maximum pull-out resistance of the packer is found with 80 bar, which results in a factor of safety of 3.2 for the worst-case scenario of smooth borehole walls (steel) in laboratory tests. The installation of the standpipe packer requires a modification of the quick coupling of the drill rig to insert the packer in the pre-drilled borehole instantly. Additional cylinders mounted on the drill rig facilitate the tensioning of the packer in the borehole. The guiding system supports the packer and grips the clamping sleeve on the thrust ring. A second feed cylinder clamps the standpipe packer via the clamping device. As soon as the system is mechanically locked in place, the feeding can be removed, and the entire standpipe packer and preventer are ready

Fig. 8 Innovative standpipe-packer with attached preventer and threaded tube drill pipe



Fig. 9 Reaming bit with attached guiding shoe for drilling of the standpipe-packer borehole



Fig. 10 Drill rigs with additional jacks for stand-pipe-packer installation

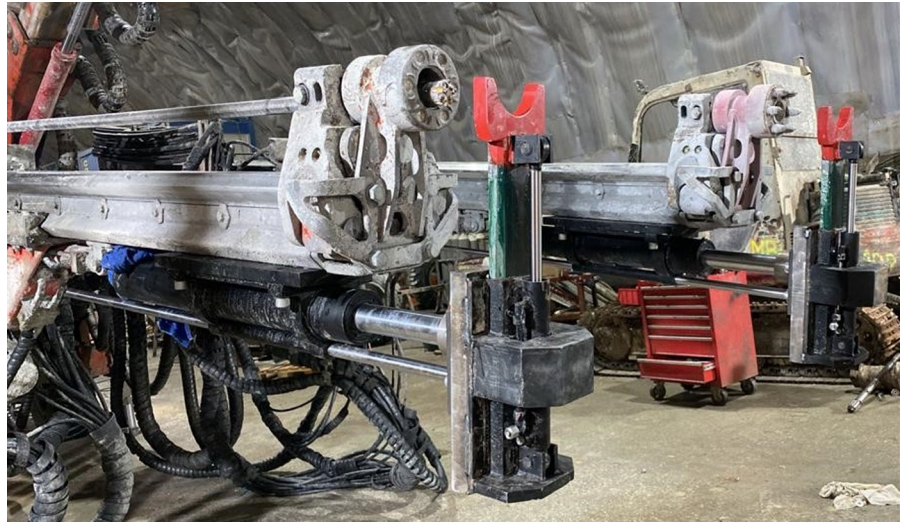

for drilling. The release of the packer after drilling requires approximately 10 min to relieve the elastomer to its original position.

4.2 Development of a Combined Polyurethane–Cement Grout Mix

Grouting facing high groundwater conditions with large apertures is prone to wash-out effects. Cementitious grout mixes filtrate under high pressure and dilutes in contact with water. Specific anti-washout agents (AWA) were recently used in the industry to maintain appropriate reaction times and prevent the grout mix from dispersion.

Successful applications of stabilized AWA mixes are reported for the cofferdam sealing of the Niagara Tunnel Project (Gurpersaud et al. 2012) and for the sealing of the pressure tunnel of the Uma Oya project (Wannenmacher et al. 2017a). However, the complexity lies within the operational homogeneity of the grout mix, demanding accurate metering at low dosage (0.5–3.0%). The most significant disadvantage is the limited time for processing the grout mix. In addition, high content dosages change their viscosity abruptly, with an unpredictable potential of clogging. As a result, the workability of the cement grout mix is limited to a few minutes (Jähnchen 2008).

The specifications to process the grout mix include a bleeding rate of 0%, a processing time between 5 and 45 min (depending on the polyurethane concentration), and the necessity to work with standard

equipment. Based on preliminary investigations, polyurethane (PU) was tested as an additive for cement-based grout mixes (Liebetrau 2016).

When polyurethane is added to a cement grout mix, the polyurea dehydrates the water from the cement paste. The water and heat generation reduction by the proportion of polyurethane acts as an accelerator and thickener on the cement grout mix. The reaction acceleration causes a shorter hydration phase and, at the same time, leads to a stabilizing effect on the combined cement-polyurethane grout mix (*Hybrid Grout*). The PU is embedded in the cement grout mix during the hydration phase and forms an initial structure due to the progressive poly-addition reaction, which stabilizes the wash-out effects of the grout mix.

The quality of the combined product depends on an adequate dispersion and homogenization of the initial products during the mixing process.

The injection system of the combined cement-polyurethane grout mixes consists of a grouting unit for the cement and a separate grouting unit for the polyurethane. The polyurethane addition to the cement line utilizes a standard static mixer. The initial polyurethane mixing and addition to the cement line with a standard static mixer shortly before the packer is controlled by the Groundfynk Box (2020). Figure 11 shows the impact of the PU within the cement paste on the flow behavior.

Figure 12 shows a microscopic representation of the spheres of polyurethane, the porous structures



Fig. 11 Comparison of standard cement grout mixes (left) and combined cement-polyurethane grout mixes (right)

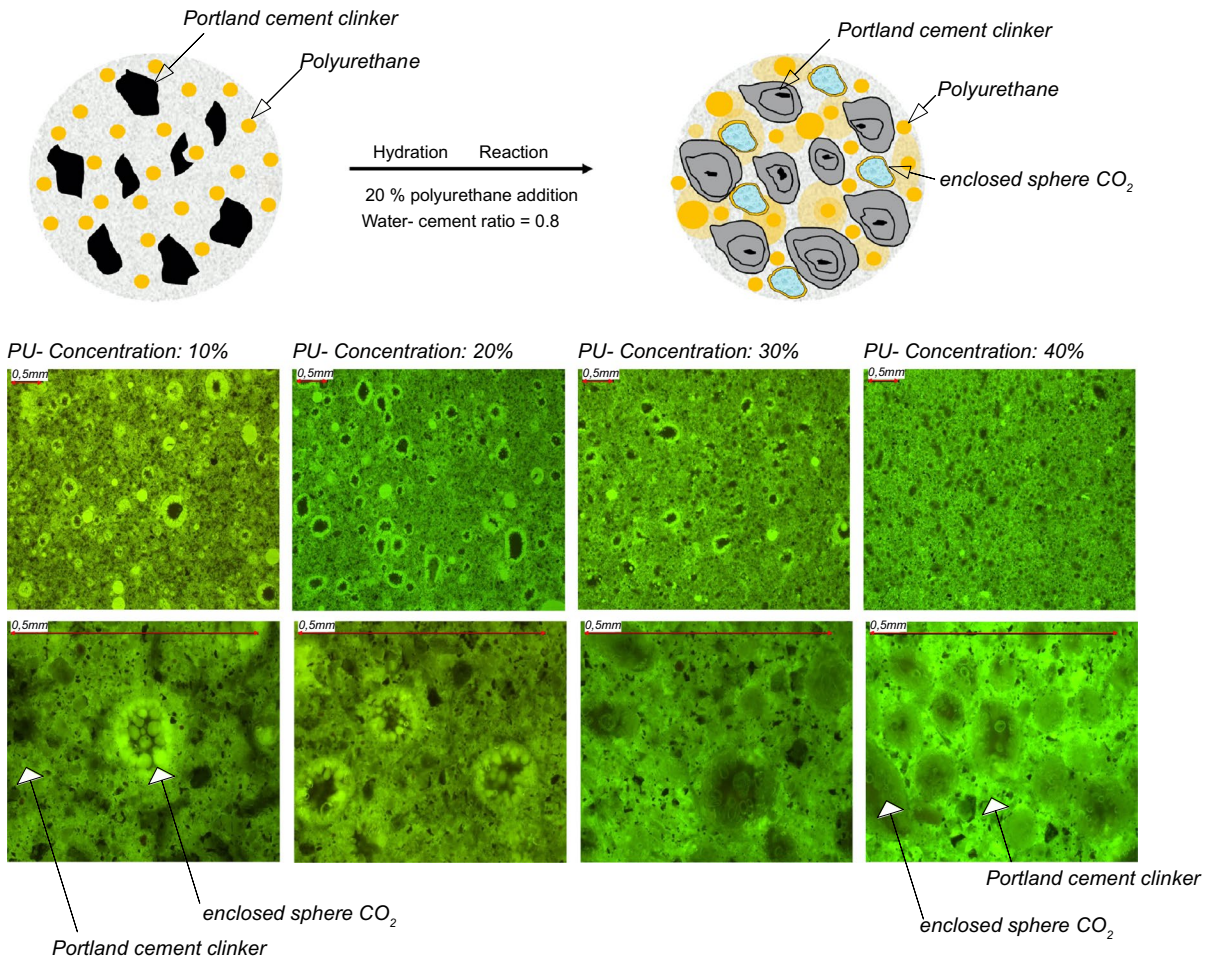

Fig. 12 Schematic illustration of cement-polyurethane mix reaction combined with a thin section of various chemistry

formed by the CO_2 and clinker grains. The size of the spheres depends on the amount of polyurethane and the resulting gas released. Combined cement-polyurethane grout mixes show good applicability for W/B ratios from 0.6 to 0.9 [–].

Laboratory tests investigated the varying polyurethane content (0, 10, 20, 30, and 40 vol.%) on the mechanical and rheological parameters. Figure 13 shows the various test results on the different combined cement-polyurethane grout mixes. The Marsh funnel allows for a rapid determination of the rheological properties of a grout mix (Kainrath et al. 2017).

The Marsh time is measured utilizing a funnel with an inner diameter of 4.76 mm of the outlet tube (DIN 2013). The flow properties of the combined cement-polyurethane grout mix show only a slight increase in Marsh funnel time (approx. 4–5 sec.) up to an initial concentration of approx. 25%. However, the Marsh funnel time of a combined cement-polyurethane grout mix increases significantly with increasing PU concentration. Limitations of the machine technology currently allow for a concentration of approximately 35%. The risk of blockages in standard grouting lines becomes apparent when the concentration exceeds 30%.

The cohesion and the filtration coefficient determine the anti-wash-out behavior of the grout mix. The formulation of the grout mix assumes a high cohesion with a low filtration in interaction with the processability. According to Lombardi (1985), the cohesion is determined using a plate cohesimeter. Cohesion increases measurably from the addition of 10% polyurethane. Adhesion to the plate rises significantly from the addition of $\geq 10\%$. The scattering of the measurements in the upper range of polyurethane addition $\geq 30\%$ is volatile. However, it shows an increased dispersion of the cohesion to indicate the partly heterogeneous processing of the high PU content and the associated reaction. The determination of the filtrate water release provides information about the sedimentation process of the solids in a grout mix and the filtration (squeezing out) of water into the surrounding ground (Chuaqui and Bruce 2003; Haslechner 2017). The tests were carried out immediately after mixing the grout mix according to the specifications of DIN (2013). For this purpose, the grout mix is first poured into a standardized cylinder (400 ml). The lower end of the cylinder withholds a free filter surface, which allows the free water of the grout mix to drain during pressure filtration (7.0 bar in 7.5 min). A concentration of approx. 20% polyurethane leads to

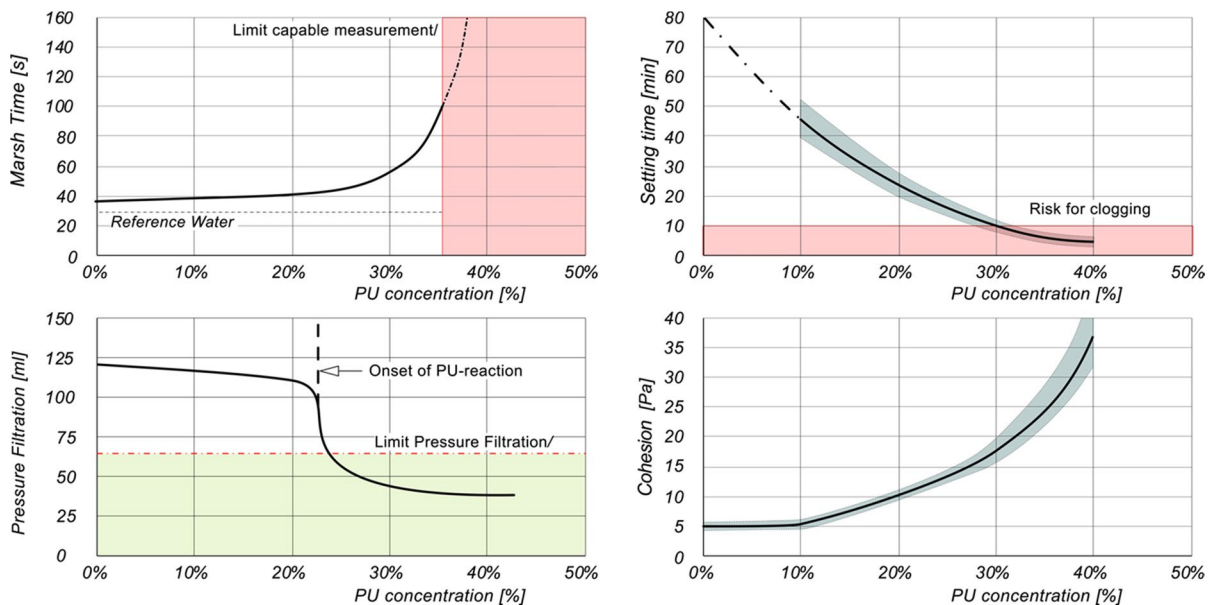

Fig. 13 Influence of the polyurethan content for a grout mix with w/c ratio = 0.8 on the Marsh time, the setting time, the pressure filtration, and the cohesion, measured with a plate cohesimeter

an abrupt influence on the filtrate water release and becomes apparent. The filtrate water release is highly variable throughout the test, with a strongly stagnating character as the test progresses. Therefore, the filtrate water release alone is not yet meaningful for evaluating the resistance of a grout mix to pressure filtration. De Paoli (Paoli et al. 1992) adopts the pressure filtration coefficient (pressure). The pressure filtration coefficient is calculated as the product of the quotient of the squeezed volume and the initial sample volume and a constant depending on the test duration ($k_{7.5 \text{ min}}=0.378$). The grout mixes with a low PU content (<10%) refer to a slightly stable to stable mixture, the mixes with a higher polyurethane content are far below the ideal curve of a stable cement grout mix mixture and thus represent an extension of the range of stable mixes established by de Paoli (Paoli et al. 1992).

The onset of setting defines a limit value for the workability of a grout mix as soon as it is not moved. According to Kainrath (Kainrath et al.

2017), the onset of the setting of the cement grout mix was determined when the shear stress of 100 Pa was reached for the cement grout mix. However, the addition of PU to the cement grout mix changes the inherent setting behavior of the grout mix. It poses a risk of damaging the test equipment to determine the values with a simple tilt test. Solidification begins as soon as the material in a container can be tilted by 90° without material loss. The onset of solidification is highly dependent on the PU concentration and falls to less than 10 min when 40% PU is added to the grout mix. Since the onset of solidification in this range is highly volatile, a grout mix of 30% or more can undoubtedly lead to a reaction and blockage of the lines (see Fig. 14).

The proportion of polyurethane within the grout mix considerably influences strength development. The ratio of enclosed spheres of polyurethane and pores of CO₂ leads to a significant reduction in strength compared to a pure cement grout mix. For a 40% cement-polyurethane grout mix, the decrease in strength amounts to approximately 50%.

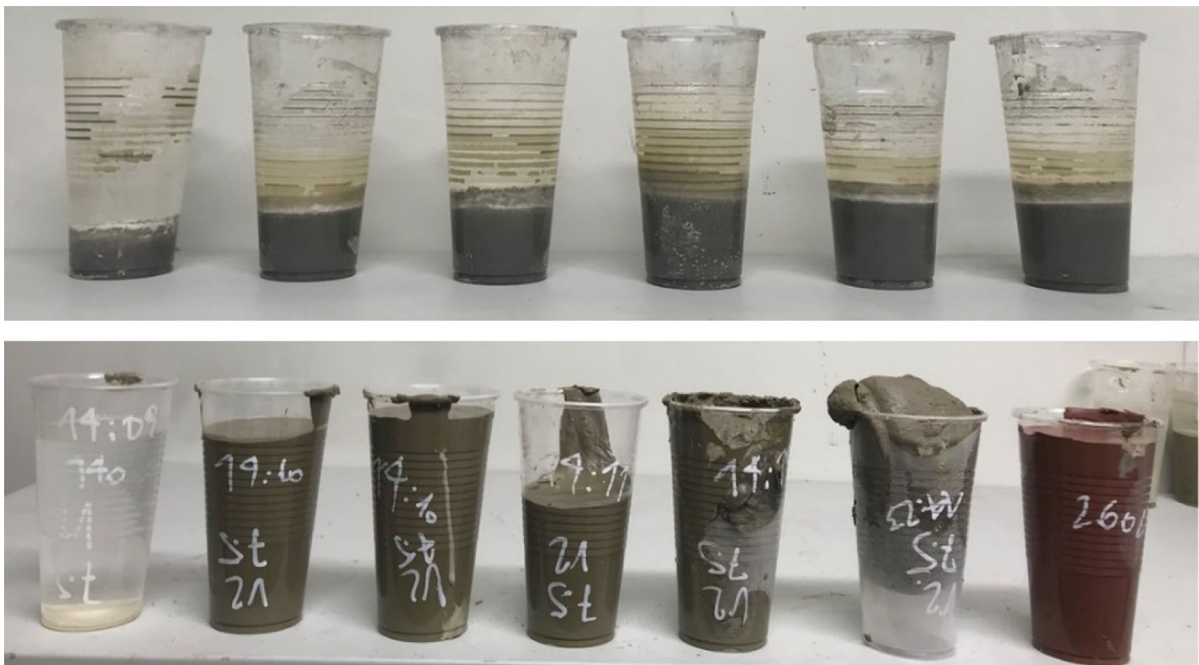

Fig. 14 Cup test with free water separation for standard (top-picture) and a combined cement-polyurethane (lower-picture) grout mix

5 Quantification of the Improved Grouting Works

The usage of the standpipe packer showed a significant impact on the overall sequence of the grouting. The mechanical standpipe packer demands no hardening time for installation, the optimized manipulation results in time-saving of approximately 6.5 h per standpipe.

Despite the main advantage of individual time saving, the standpipe packer withholds enormous flexibility since additional boreholes or shifting of defined boreholes can be facilitated within a short preparation time (Fig. 15).

Imperfections of installation, resulting in a slight shifting or displacement of the packer, can be re-tightened, even under running grouting operations. The benefits of a combined cement-polyurethane grout mix cannot be determined directly. In small-scale tests, the properties of the cement-polyurethane grout mix show improved filtration and initial stability characteristics. The actual grouting works allow drawing first conclusions of the improved properties on the operation. Lombardi (1996) suggested the q/p -value to evaluate and steer grouting works. The q/p -method compares the flow rate q [l/min] with the grouting pressure p [bar] over time. The q/p -value is independent of the mode of operation.

Comparing the grouting time to reach a q/p -value of ≤ 0.2 l/(min*bar), the grout mix showed an average grouting time of approximately 22 min per borehole for the combined cement-polyurethane grout mix, while the standard cement grout mixes resulting in grouting time of roughly 33 min per borehole. When reaching the volume criteria, a similar trend is observed for q/p -value ranging from 0.2 to 2.0. However, the system's main advantage relies

on intermittently adding polyurethane to the cement grout mix to temporarily increase the mixtures' rheology. This approach allows control of the grout spread and, to a certain extent, even so, the grout mix's dilution potential. The system's effectiveness is demonstrated with three individual records, showing partial and temporal addition of polyurethane to the grout mix to reach a defined penetration, or plugging of the system (see Fig. 16).

The evaluation of q/p -values of advance sealing injections shows a range of values at the beginning of the injection from 1.5 to approx. 3.0 l/(min*bar). The steady reduction of the q/p -value indicates saturation of the defects of a rock mass. Accordingly, the slope of the q/p -value can be used to conclude the effectiveness of the injection.

According to Lombardi (1996), sufficient ground saturation is achieved when the q/p -value reaches a level of ≤ 0.2 l/(min*bar) for standard cement mixes. However, the initial level is kept as reference, while the decay of the q/p -value over time, expressed as the gradient, is in the foreground.

Example 1 in Fig. 16 shows a grouting operation with a temporary addition of 10% polyurethane upon exceedance upon 120 min. The combined cement-polyurethane grout mix's increased viscosity leads to an immediate pressure increase with a constant flow rate and a corresponding decrease in the q/p -ratio. The following change towards a standard grout mix results in a horizontal plateau of the q/p -value without further saturation. The addition of the cement-polyurethane grout mix led to a significant decrease of the q/p -ratio, which can be interpreted as a plug of the grout mix within the open voids. At the same time, the sole application of cement indicated dilution of the material.

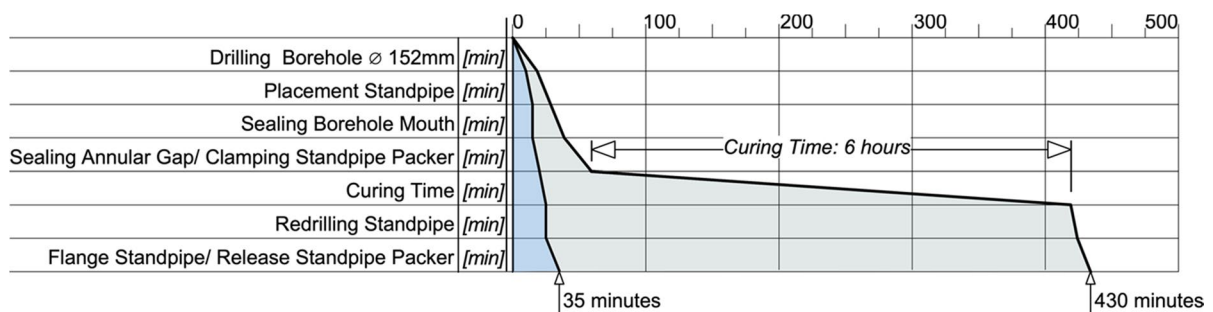

Fig. 15 Comparison of construction time for standard standpipes and mechanical standpipe-packers

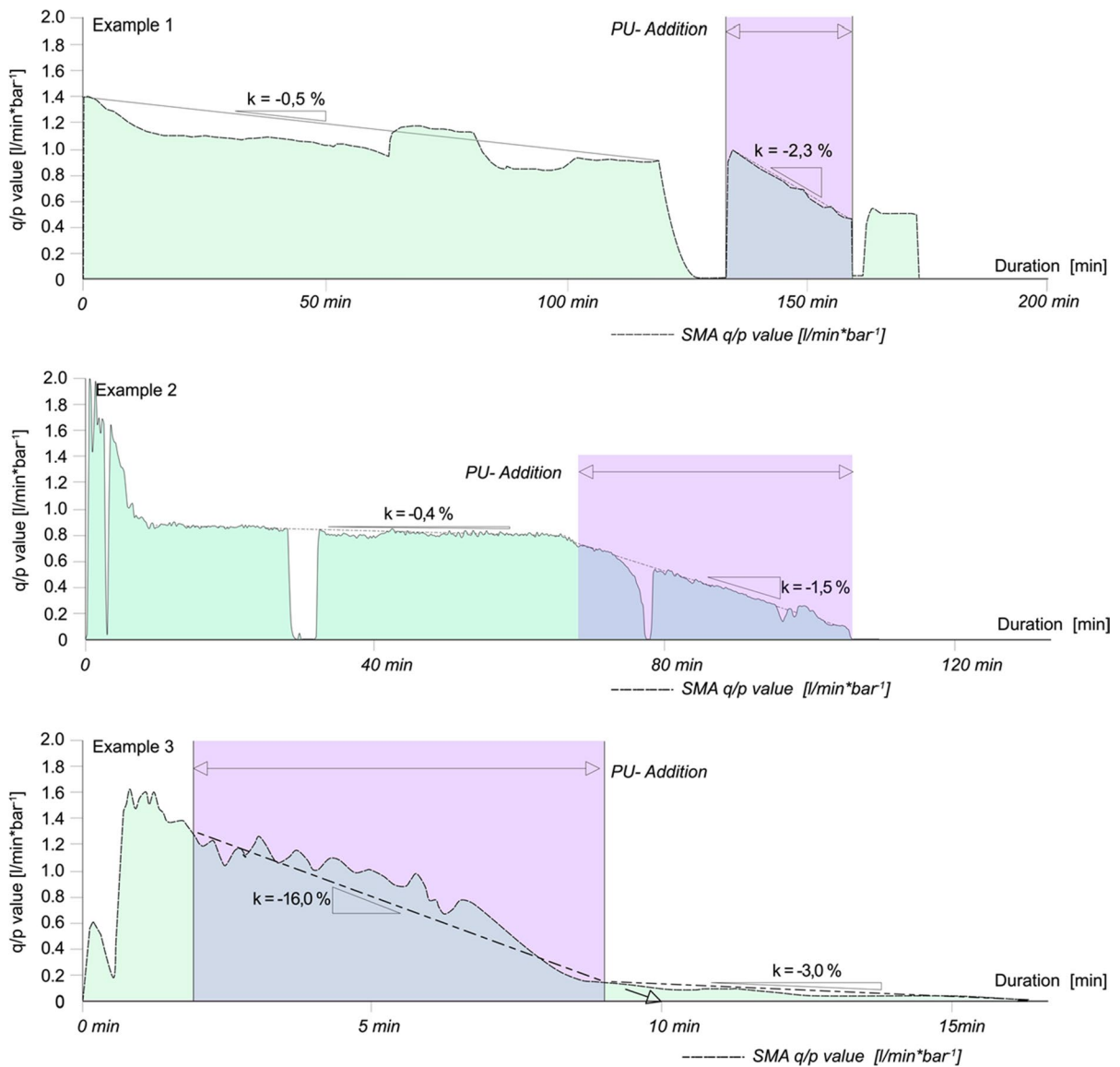

Fig. 16 Performance of combined cement and polyurethane grout mixes

Example 2 in Fig. 16 shows a similar grouting operation with a temporary addition of 10% polyurethane upon exceedance of a defined volume upon 70 min. However, the q/p -ratio (negative slope of 1.5%) decrease is smaller than in example 1, with a negative slope of 2.3%. This is because the grouting operation was entirely completed with the addition of polyurethane. The example shows that the reduction of the q/p -ratio can be continued until the voids have been sufficiently filled.

Example 3 in Fig. 16 shows the process of pre-excavation grouting with a temporal addition of 20% PU immediately after filling the borehole and reaching the maximum q/p -value. The addition of polyurethane introduces a relatively steep gradient of the q/p -ratio. Upon reaching a pressure plateau at a reduced flow rate, a stagnation of the q/p -curve occurs. The lower gradient as an expression of the minor q/p -ratio leads to a prolonged grouting

operation of approximately 7 min with a corresponding volume of approx. 7 litres.

6 Conclusion

Experiences in tunneling facing high water conditions over long sections of several hundred meters are extraordinary. Many tunneling projects faced severe downtime when exposed to high water inflow conditions within shorter or longer sections (Elektro-Watt Zürich 1959). From a tunneling perspective, the groundwater pressure, the storage coefficient, and the affected length of the section defines the utilization of grouting works. Significantly longer sections with the necessity of continuous grouting works demand the integration of the tunneling grouting works within the time-defining grouting works. While several case studies of tunnels encountering large water inflows are well-documented (Garshol 2011; Liebetrau 2016), minor experiences exist in the continuous integration of grouting works within long tunnel sections.

The tunnel excavation of significant groundwater-bearing ground formation is challenging, as shown in the current construction works of the Semmering Base Tunnel in Austria. Consequently, integrating grouting works within the tunnel excavation is complex and demands constant on-site adoption and optimization. The optimized standpipe-packer gained immense flexibility and savings of unproductive downtime within the excavation cycle. Additional adoptions to the grouting scheme can be adopted within a short time. The combined cement-polyurethane grout mix (hybrid grout) led to an entirely changed approach to prosecuting the grouting works. The addition of polyurethane to the grout can be adopted to introduce a specific plug within discontinuities to limit the penetration or dilution of the grout. However, the amount and the duration of polyurethane added to the cement grout mix depends on the site conditions and skills of the operators.

Funding Open Access funding enabled and organized by Projekt DEAL. The authors have not disclosed any funding.

Data Availability Enquiries about data availability should be directed to the authors.

Declaration

Conflict of interest The authors have not disclosed any competing interests.

Open Access This article is licensed under a Creative Commons Attribution 4.0 International License, which permits use, sharing, adaptation, distribution and reproduction in any medium or format, as long as you give appropriate credit to the original author(s) and the source, provide a link to the Creative Commons licence, and indicate if changes were made. The images or other third party material in this article are included in the article's Creative Commons licence, unless indicated otherwise in a credit line to the material. If material is not included in the article's Creative Commons licence and your intended use is not permitted by statutory regulation or exceeds the permitted use, you will need to obtain permission directly from the copyright holder. To view a copy of this licence, visit <http://creativecommons.org/licenses/by/4.0/>.

References

- ASTM D2240-05 (2010) Standard test method for rubber property—durometer hardness. <https://www.astm.org/d2240-05.html>. Last accessed 2022/04/01.
- Chuaqui M, Bruce D (2003) Mix design and quality control procedures for high mobility cement based grouts. In: Third international conference on grouting and ground treatment, New Orleans [https://doi.org/10.1061/40663\(2003\)64](https://doi.org/10.1061/40663(2003)64).
- DIN 4126:2013-09 Nachweis der Standsicherheit von Schlitzwänden (2013).
- Elektro-Watt Zürich.: Erfahrungen beim Betrieb der Kraftwerke Mauvoisin, Sonderdruck SBZ Heft 39 (1959).
- Entfellner M, Hauer H, Bauer J (2021) Logistic challenges at contract SBT 1.1—Intermediate construction access Göstritz / Logistische Herausforderungen beim Baubau SBT 1.1 - Zwischenangriff Göstritz. *Geomechanics and Tunneling*, 14(3), 270–285. <https://doi.org/10.1002/geot.202100011>.
- Garshol KF (2011) Pre-Excavation Grouting, 4th edition. BASF Construction Chemicals Europe Ltd.
- Gobiet G, Nipitsch G (2015) The long path to approval of the Semmering Base Tunnel and the effect on construction progress / Der lange Weg zur Genehmigung des Semmering-Basistunnels und Auswirkungen auf den Bauablauf. *Geomechanik Tunnelbau* 8:547–553. <https://doi.org/10.1002/geot.201500036>
- Gobiet G, Wagner OK (2011) The new semmering base tunnel project / Das Projekt Semmering-Basistunnel neu. *Geomechanik Tunnelbau* 6:551–558. <https://doi.org/10.1002/geot.201300041>
- Groundfynk: Manual Groundfynk Box Vs.1, Vienna (2020).
- Gurpersaud N, Chuaqui M, Lees D, Lam W, Hu F (2012) Intake Shaft Grout Curtain for the Niagara Tunnel Project. In: Proc. Fourth Int. Conf. Grouting Deep Mix., pp. 903–913.

- GZ. BMVIT-820.288/0024-IV/SCH2/2015, ÖBB-Strecke Wien Süd – Spielfeld/Straß, km 75,561 –km 118,122 (2015).
- Haslehner B (2017) Digital quality management for conducting quality checks of injection grouts. Technische Universität Wien, Fakultät für Bauingenieurwesen
- Holzer R, Prall K, Wagner OK, Gobiet G (2020) Semmering base tunnel—tunnelling in challenging geotechnical and geological conditions in major fault zones. *Geomech Tunnell* 13:509–518. <https://doi.org/10.1002/geot.202000029>
- Jähnchen B (2008) Untersuchungen zum Verhalten Anti-Wash-Out stabilisierter Zementsuspensionen, Hochschule Wismar, Wismar.
- Kainrath A, Hornich W, Wannemacher H (2017) Rheologische und mechanische Eigenschaften von zementgebundenen Injektionsstoffen, In: ÖGG Spezialseminar Injektionen, <https://s3.nl-ams.scw.cloud/assets.oegg.at/attachments/ckdzov55s007z0xlm4czc9acl-oegg-works-hop-injektionen-gmk2017.pdf>, Salzburg.
- Liebetrau N (2016) Polyurethaninjektionen in heiße Druckwasserquellen beim Straßentunnel Vadlaheidi in Island, In: Forum Injektionstechnik 2016, Köln.
- Lombardi G (1985) The role of cohesion in cement grouting of rock, Lausanne.
- Lombardi G (1996) Selecting the grouting intensity. *Int J Hydropower Dams* 3(4):62–66
- ÖBB-Infrastruktur AG (2022), Ausführungsunterlagen.
- de Paoli B, Bosco B, Granata R, Bruce DA (1992) Fundamental observations on cement based grouts. In: ASCE conference on grouting, Soil Improvement and Geosynthetics, pp. 474–485.
- Wagner OK, Haas D, Druckfeuchter H, Schachinger T (2015) The challenges of contract SBT1.1 “Tunnel Gloggnitz”/ Die Herausforderungen des Bauloses SBT1.1 Tunnel Gloggnitz. *Geomechanics and Tunnelling*, 8: 554–567. <https://doi.org/10.1002/geot.201500038>.
- Wannemacher H, Hosseini A, Wenner D, Rahbar A, Shahrokia Z (2017a) Water Ingress and Reduction Measures in the Headrace Tunnel at the Uma Oya Multipurpose Project, Hydro-2017a, Lausanne.
- Wannemacher H, Pfeffer R, Walter A, Christöphl B (2017b) Baulos SBT3.1: Bohr- und Injektionsarbeiten für den Schacht Sommerau 2, In: ÖGG Spezialseminar Injektionen, <https://s3.nl-ams.scw.cloud/assets.oegg.at/attachments/ckdzov55s007z0xlm4czc9acl-oegg-works-hop-injektionen-gmk2017b.pdf>, Salzburg.
- Wannemacher H, Entfellner M, Krenn H (2019) Considerations for rock mass grouting for tunnelling in faulted rock masses with tubes á manchette. *Geomech Tunnell* 12(2):158–167. <https://doi.org/10.1002/geot.201800072>
- Wieland G, Prall K, Lenz G, Schachinger T, Gobiet G (2018) Semmering Base Tunnel—Design and construction of the shaft head caverns under difficult conditions / Semmering-Basistunnel - Planung und Bau der Schachtkopfkavernen unter erschwerten Bedingungen. *Geomech Tunnell* 11(5):462–470. <https://doi.org/10.1002/geot.201800040>

Publisher’s Note Springer Nature remains neutral with regard to jurisdictional claims in published maps and institutional affiliations.