

Performance diagnosis of Mae Lao irrigation scheme in Thailand (II). Application of the UIWDC model for water distribution system analysis

Unggoon Wongtragoon · Naritaka Kubo · Hajime Tanji

Received: 8 September 2010/Revised: 13 June 2011/Accepted: 1 July 2011/Published online: 21 July 2011
© The Author(s) 2011. This article is published with open access at Springerlink.com

Abstract The Unsteady Irrigation Water Distribution and Consumption (UIWDC) model is applied to analyze causes of uneven water distribution between the upstream and downstream beneficial areas of the Mae Lao Irrigation Scheme (MLIS). The uneven water distribution may be caused by inadequate water distribution facilities or improper operation rule; therefore, its causes are examined systematically and quantitatively from the aspects of “water allocation” and “operation rule”. The water allocation is considered focusing on the dry season irrigation, where equity and efficiency should be especially balanced because of the scare water resources. The “EQTY index” (the equity index) is defined to widen the range of consideration between the equity and the efficiency, instead of alternative judgment of which has a priority. The operation rule for facilities in the MLIS is assumed considering their capacities, and two coordinate values of “ineffective spillage” and “water deficit” in the scheduled areas are incorporated into operation rule to quantitatively diagnose the system performance. As a result, the original causes of

uneven water distribution will presumably be identified. The informative and quantitative results are utilized to set a new benchmark performance of the MLIS for the water distribution. It can be described by the “Expected Ratio of Irrigable Area” (ERIA) and “Present Ratio of Irrigable Area” (PRIA). Based on this standard, the general recommendations can be more concretely proposed to raise the water distribution performance of the MLIS such as by improving distribution facilities and/or by installing vertical pumps.

Keywords The UIWDC model · Uneven water distribution · Performance diagnosis of irrigation system · Inadequate design of water distribution system · Water allocation plan · The EQTY index · Operation rule of water distribution

Introduction

In the Southeast Asian countries, paddy rice can be grown throughout the year if water is available because other conditions are suitable for its cultivation (Marten 1986). Most surface irrigation schemes in this region were designed to service full command areas during the rainy season by providing supplemental irrigation water. However, in the dry season, only some command areas of these systems are able to be irrigated because of the limitation of available water.

Operation of these irrigation schemes under the moderate water deficit circumstance is a complicated task (Sagardoy et al. 1986) because not only the efficiency of water use but also the equity of water distribution must be considered. These combined objectives of water allocation plan are difficult to be harmonized because, for example,

U. Wongtragoon (✉)
United Graduate School of Agricultural Science, Tokyo
University of Agricultural and Technology, 3-5-8 Saiwai-cho,
Tokyo, Fuchu 183-8509, Japan
e-mail: unggoon@gmail.com

N. Kubo
Water Systems Engineering Laboratory, Tokyo University
of Agricultural and Technology, 3-5-8 Saiwai-cho,
Tokyo, Fuchu 183-8509, Japan

H. Tanji
Laboratory of Coastal Engineering, Department of Geotechnical
and Hydraulic Engineering, National Institute for Rural
Engineering, 2-1-6 Kannondai, Ibaraki,
Tsukuba 305-8609, Japan

the equity requires long water transportation accompanied by conveyance loss. According to Watanabe (1999), when water is being distributed in a long canal system, the conveyance loss amounts to about 7–66% of the intake flow. It mainly consists of canal seepage, operation losses, leakage, and evaporation (Allen et al. 2007).

The most significant part of the conveyance loss is the canal seepage, which is influenced by the canal surface condition; lined or unlined, and nearly proportional to canal length. Therefore, it plays a significant role for the consideration of water allocation plan particularly in the large scale irrigation project having a long earthen canal (Xie et al. 1993; Alam and Bhutta 2004; Akkuzu et al. 2006). Water allocation planning in such an irrigation system becomes a complex task, but the plan should be rationally determined according to the amount of available water and conditions of irrigation facilities.

Necessity and objectives of this research

Research necessity

The Mae Lao Irrigation Scheme (MLIS) was developed in the south of Chiang Rai province, northern Thailand. It was first designed to provide supplemental irrigation only in the rainy season. In 2003, the Mae Suai Dam was constructed, and the MLIS modernization project was started by upgrading the Main Canal system and establishing the Water User's Group (WUG). This project enables to expand irrigable areas in the dry season.

The final water allocation plan for dry season has not yet been decided because the dam reservoir capacity is too modest to supply water to all command areas, and it makes allocation planning difficult and complex. Just after the dam construction and canal upgrading, the continuous water distribution method was practiced the same as in the rainy season. However, a serious water deficit occurred in the expanded areas.

To remedy this difficulty and to reduce water demand, protocols instructed in the operation manual were notified to the WUGs, for example, decreasing scheduled areas or introducing an alternative cropping pattern which requires lower water demand. However, these protocols were often ignored, and farmers often took a risk instead of adopting safe and technically possible measures. Then, the rotational water distribution method was adopted instead dividing all beneficial areas into four branches. As a result, the situation improved slightly, but water deficit is still serious particularly in the downstream areas.

Five campaigns of field reconnaissance were carried by our research group to find out possible causes of this problem and the following facts were confirmed. (1) Poor

operation monitoring, lack of field agent and flow measurement instruments, (2) Inadequate design of the canal system and control structure, (3) Enlargement of un-registered areas to be irrigated, (4) A lack of regulation observance of water distribution rules, and (5) Impermissible or illegal operation of key control structures at the night time.

However, the dominant causes of this problem could not be identified exactly because information is definitely lacking on temporal flow variables and conveyance losses along the canal. The flow variables include flow rate and water level, and the conveyance losses include seepage, spillage, and leakage losses. In the case of the MLIS, discharges are not measured even at major diversion points. As a tool to investigate such information, our group has developed the Unsteady Irrigation Water Distribution and Consumption (UIWDC) model, details of which are reported in the previous research (Wongtragoon et al. 2009). The UIWDC model cannot reproduce an exact fact, but it is expected to show an essential relation of cause and effect. As for the poor operation monitoring, for example, the UIWDC model can simulate irrigation activities under two extreme conditions; perfect monitoring and poor monitoring. If their performances are significantly different, the monitoring is considered to be a key factor to improve the irrigation performance, but if not then the monitoring is not a key factor.

As the first application of the UIWDC model, the water allocation issue will be analyzed together with the examination of above causes because it is the most urgent and primary problem and it significantly affects the results of above five causes. Water allocation planning is a difficult task. It must be decided considering available water amount, and balancing water use efficiency and water distribution equity.

Research objective

The primary objective of this article is to diagnose the MLIS with regard to water distribution performance systematically and quantitatively utilizing the UIWDC model.

Following two new aspects of “water allocation” and “operation rule” are introduced to facilitate the diagnosis.

- (1) The dry season water allocation plan where the “equality” and “efficiency” of water distribution are considered comprehensively.
- (2) The particular operation rule applicable to diagnose the water distribution performance of the MLIS, considering “ineffective spillage” and “water deficit”.

The diagnosed results can be used to identify real causes of uneven water distribution between the upstream and downstream beneficial areas.

Description of study area

The MLIS is a large scale irrigation system. Irrigation water is diverted by the Mae Lao Weir which was constructed across the Mae Lao River in 1950, and the whole MLIS was completed in 1963. The total project area is 29,440 ha, of which 23,680 ha can be irrigated. The Mae Suai River is a tributary of the Mae Lao River located 30 km upstream of the Mae Lao Weir. The Mae Suai Dam was constructed with a storage capacity of 77 million cubic meters (MCM). The purpose of the dam is to supply water to the MLIS for the dry season cropping (Royal Irrigation Department 2003). For the better operation and maintenance, the MLIS is divided into four branches as shown in Fig. 1.

The canal system consisted of two main earthen canals, the left and right main canals. The length of the Left Main Canal (LMC) is 24.32 km, the maximum flow rate is 8.50 m³/s, and beneficial area is 5,600 ha. In 2007, it was rehabilitated and improved by concrete lining, and the max capacity is increased. The length of the Right Main Canal (RMC) is 49.48 km, the maximum flow rate is 26.70 m³/s, and beneficial area is about 18,000 ha. The canal surface was lined, and maximum capacity was increased in 2002. Recently, since

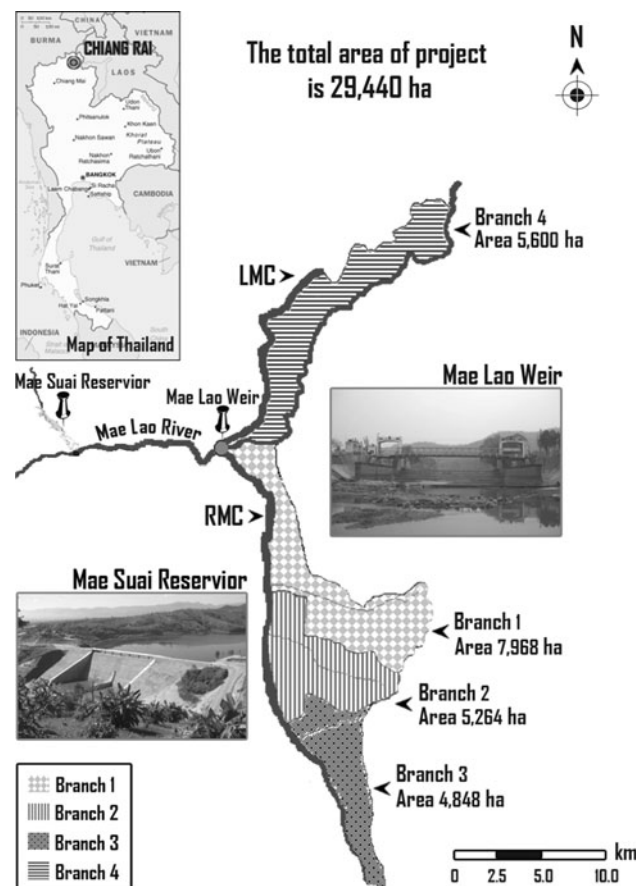

Fig. 1 Map of Mae Lao Irrigation Scheme

2009, the irrigation system's modernization has implemented by installing automatic system to monitor water levels at key points and to send such data to the control center.

In this research, areas under the RMC are selected as research areas, which cover the largest portion of the project. There are 22 secondary canals and 5 sub-secondary canals with a total length of 90.75 and 15.69 km, respectively (Royal Irrigation Department 1999).

The climate of this region is tropical monsoon. As referred to the 24 years' average 1980–2003, the dry season is from November to April, and the total rainfall during the dry season varies from 7.08 to 72.87 mm with an average of 29.47 mm (Royal Irrigation Department 2003). This study focuses on irrigation activities during the dry period, when irrigated water is consumed only by evapotranspiration and seepage, and water supply from rainfall is scarce and unreliable.

Methodology

In order to fulfill the research objective, the UIWDC model is applied to the MLIS according to scheduled the water allocation plan and assumed the operation rule. Here, the features and parameters of the "UIWDC model" are briefly explained, and the "water allocation plan" and "operation rule" are described in detail.

UIWDC model

The detailed description of the UIWDC model is referred in the previous article (Wongtragoon et al. 2009). Only primary features are explained here. This model basically consists of two components, the unsteady flow model which distributes water to paddy fields, and Paddy Tank model where irrigated water is consumed.

Unsteady flow model

The unsteady flow model has four distinctions; (1) the scheme is explicit, (2) the model can simulate processes of filling and emptying canal, (3) the canal system consists of 196 reaches connected by interior boundaries where calculation is carried out implicitly using the Newton–Raphson method, and (4) water withdrawal through Farm Turnout (FTO) is treated as the side flow because of excessively many FTOs in a reach. The term "reach" means canal portion bounded by two interior boundaries.

Paddy tank model

The Paddy Tank model is an aggregate consisting of about 680 Paddy Tanks, where water is consumed by evapo-

transpiration, run-off, and deep percolation. One Paddy Tank corresponds to one paddy field block, the size of which is supposed to be less than 25 ha. Each Paddy Tank is composed of three tanks being set vertically. The upper, middle, and lower tanks represent “ponding depth of the paddy field”, “water content in the plow layer”, and “ground water”, respectively (Wongtragoon et al. 2009).

Computational setting and simulation conditions

- (1) Mesh size for distance Δx is basically 100 m in major canals, but smaller size as small as 40 m is adopted for minor and steep canals. Mesh size is set individually for each reach.
- (2) Mesh size for time Δt is fixed to 10.0 s.
- (3) Manning’s roughness coefficient is set as 0.030 for the unlined canal according to Chow (1959) because the RMC is constructed parallel to hillside and cobblestones are observed at the horizontal edge. For the lined canal, it is set as 0.018 because some canal surfaces are noticeably covered by sedimentation and weed.
- (4) Seepage loss rate through the wetted canal surface is set as $8.0 \times 10^{-6} \text{ m}^3/\text{m}^2/\text{s}$ for the unlined canal. This value was estimated from the field experiment carried out by Inflow–Outflow Method in a similar irrigation system, Lam Nam Oon Irrigation Project in Thailand. According to Skogerboe and Merkle (1996), seepage loss was about 30% of inflow in case of a big scale irrigation project in which the canal is unlined. In case of the lined canal, it is set as $2.0 \times 10^{-6} \text{ m}^3/\text{m}^2/\text{s}$ which is the maximum value for the lined canal proposed by FAO (Allen et al. 2007).
- (5) Water leakage was observed through a gate gap beneath a spillways’ emergency gate. The gate gap is a space between the gate bottom and the gate frame. Water leakage level is considered to indicate the maintenance level. Therefore, four ranges of gate gap; 0, 4, 8, and 12 mm are set corresponding to good, fair, poor, and very poor maintenance levels, respectively.
- (6) The distance to the reach is measured from the intake point to the center of the reach.
- (7) Water requirement (WR) at the paddy field is fixed to a constant value of 14.7 mm/day. This value is the WR at the planning stage of the project.
- (8) Each FTO can withdraw water from the canal when water is deeper than 2.5 cm, and the water level is higher than “full supply level-80 cm”. First condition means that water withdrawal is very difficult when the water depth is very shallow. The second condition comes from the fact that the elevation of the FTOs’ sill height is around “full supply level-80 cm”.

Water allocation plan

If available water is insufficient, the irrigation area must be limited according to the particular water allocation plan. There are two extremely contrastive water allocation methods. The first perspective relies priority on water use efficiency with minimum losses, and supplies water only to the upstream areas close to the intake point. The second perspective relies priority on the equal water distribution with much water losses. In general, the allocation plan should be decided according to the amount of available water and the condition of irrigation facilities. In order to decide the configuration of water allocation, the EQTY index is introduced here.

EQTY index

The EQTY index is proposed to characterize a water allocation pattern representing the fairness of water distribution level. This index is defined in this study as follows, using the Eq. 1 with two ratios, TIR and RAIR.

$$\text{EQTY} = \frac{\log(\text{RAIR})}{\log(\text{TIR})} \quad (1)$$

where TIR is the abbreviation of Total Irrigation Ratio (“total irrigation area in a scheme” divided by “total paddy field area in a scheme”), and RAIR is Ratio of Area to be Irrigated in a Reach (“irrigation area in a reach” divided by “paddy field area in a reach”). The definition of the EQTY index is aimed to systematically define the continuous ratio changing of water distribution pattern bounded and controlled by the perspectives of the efficiency and the fairness.

Figure 2 explains the EQTY index relating to three ratios, TIR, RAIR and RRIS, which is Ratio of Reaches to be Irrigated in a Scheme (“area of reaches to be irrigated in a scheme” divided by “total paddy field area in a scheme”).

In Fig. 2, the area of the largest rectangle corresponds to “total paddy field area in a scheme”. The area, the height, and the side of the gray rectangle correspond to TIR, RAIR, and RRIS, respectively. Accordingly, $\text{TIR} = \text{RAIR} \times \text{RRIS}$. A narrow long rectangle shows the area of the corresponding reach in a scheme.

The EQTY index is 0.00 as in Fig. 2a when water is exclusively distributed to areas close to the intake point. On the contrary, EQTY is 1.00 as in Fig. 2d when water is evenly distributed to all reaches. There may be many water allocation patterns between above two extreme cases, including configuration of allocation patterns. In this study, the simplest configuration, i.e., the rectangular pattern as shown by the gray rectangle in Fig. 2 is chosen, and an

Fig. 2 Concept of EQTY

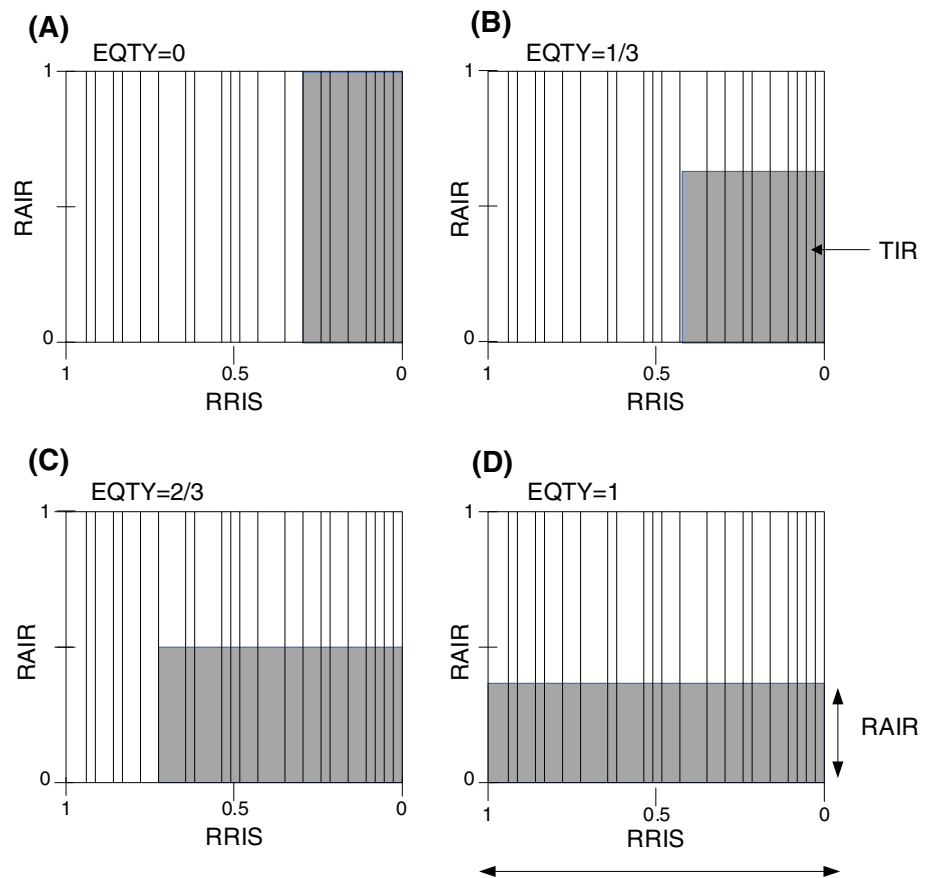

intermediate allocation pattern is related to its corresponding EQTY value by the Eq. 1.

Water allocation configurations

Figures 2a–d show configurations corresponding to EQTY values. Tables 1 and 2 show RRIS and RAIR, respectively, corresponding to EQTY values for given TIR. We can consider two aspects of water allocation; the upper aspect is “from intake point to reaches”, and the lower aspect is “from reach to paddy field block”. For example, “EQTY = 1.00” in Tables 1 and 2 means all reaches are irrigated within the upper aspect (RRIS); however, the ratio of irrigation area in a reach (RAIR) decreases accordingly within the lower aspect. Meanwhile “EQTY = 0.00” means preferential allocation to reaches located in the upstream (the upper aspect), and paddy field blocks are irrigated if they belong to allotted reach, but are not if they do not (the lower aspect).

Operation rule

The uneven water distribution of the MLIS is quantitatively analyzed applying the UIWDC model examining the equity and efficiency of water allocation plan. Actually, facilities

are operated without ceasing, and supply and demand are always changing. However, we will consider “static water distribution” where water demand and supply are balanced. It is assumed that water demand is constant throughout the season, and water is delivered to scheduled areas by the continuous water distribution method. The rotational water distribution method is not analyzed in this article.

In order to realize such a static water distribution, we set following the operation rule.

Figure 3 shows the schematic procedure of the gate operation.

- (1) Initial states of the irrigation canals are empty, and the WR at the paddy field is fixed to a constant value of 14.7 mm/day.
- (2) Each FTO tries to withdraw water corresponding to its responsible area; however, if it cannot take enough water, then it demands discharge increase to its immediate diversion work by the deficit value (QMD or QLD in Fig. 3). The immediate diversion work means “the intake gate” if the FTO is the direct diversion, “the lateral off-take gate” if the FTO belongs lateral canal.
- (3) Discharge leaving the terminal reach is regarded as ineffective spillage, and it demands its immediate

Table 1 Ratio of reaches to be irrigated in a scheme (RRIS) versus EQTY for given TIR

RRIS		EQTY				
		0.00	0.25	0.50	0.75	1.00
TIR	0.10	0.10	0.18	0.32	0.56	1.00
	0.30	0.30	0.41	0.55	0.74	1.00
	0.50	0.50	0.59	0.71	0.84	1.00
	0.70	0.70	0.77	0.84	0.91	1.00

Table 2 Ratio of area to be irrigated in a reach (RAIR) versus EQTY for given TIR

RAIR		EQTY				
		0.00	0.25	0.50	0.75	1.00
TIR	0.10	1.00	0.56	0.32	0.18	0.10
	0.30	1.00	0.74	0.55	0.41	0.30
	0.50	1.00	0.84	0.71	0.59	0.50
	0.70	1.00	0.91	0.84	0.77	0.70

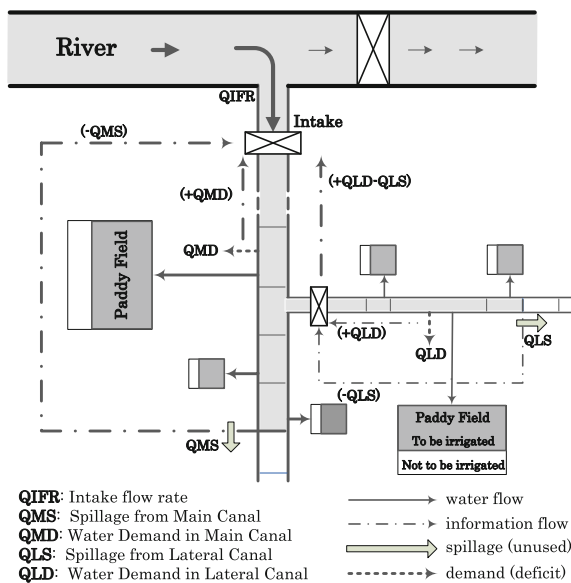

Fig. 3 Schematization of water distribution and information flow with adjusting inflow rate and off-take gate openings

diversion work to reduce the discharge by the spillage value (QMS or QLS in Fig. 3). The terminal reach is not always the tail end reach in the canal line, but the most downstream reach to which water is scheduled to be supplied.

- (4) Corresponding to the demand, the diversion work changes its target discharge by adding or subtracting the demanded value to/from the current diversion discharge.
- (5) If one diversion work is demanded at the same time to increase and decrease the target discharge, the target discharge is increased by the difference of the

increase and decrease demands. When the flow attains equilibrium in the irrigation system, then the increase demand is equal to the decrease demand.

- (6) Deficit and spillage information is transmitted not only to the immediate diversion work, but also to the higher diversion works successively demanding the change of target discharges, and finally integrated information goes to the highest work, that is, the intake weir, to change its intake flow rate.
- (7) Target values for intake and off-take discharges are decided on daily base, but off-take gate openings are adjusted on hourly base. The off-take discharge may not be remained constant with the elapse of the time because the flow is unsteady. This hourly operation adjusts errors.

After 10 days of numerical simulation, the flow can be assumed steady, and the following relation is obtained;

$$\begin{aligned}
 [\text{Intake flow rate}] &= [\text{Seepage loss}] \\
 &+ [\text{Actual off – take discharges}] \\
 &+ [\text{Spillage}].
 \end{aligned}$$

Because “Water deficit” is equal to “Spillage” at equilibrium state, and because “Planned off-take discharges” minus “Actual off-take discharges” is equal to “Water deficit”, the above relation can be rewritten as follows.

$$\begin{aligned}
 [\text{Intake flow rate}] &= [\text{Seepage loss}] \\
 &+ [\text{Planned off – take discharges}].
 \end{aligned}$$

Results and considerations

Numerical simulations are carried out to examine the performance of water distribution system in two conditions

of canal surface, lined and unlined. Simulation scenarios for the lined canal are 80 combinations of the following water allocation plans of TIR (0.1, 0.3, 0.5, or 0.7), EQTY (0.00, 0.25, 0.50, 0.75, or 1.00), and gate gap (0, 4, 8, or 12 mm). For the unlined canal, simulation scenarios are the same as the lined canal; however, the water allocation plan of TIR = 0.7 cannot be simulated because it requires higher intake flow rate than the maximum capacity of the RMC. The simulation period is 10 days. Some outputs for TIR = 0.3, EQTY = 0.50 are shown below.

Outputs examples for TIR = 0.3 and EQTY = 0.5

Water surface profiles

Figure 4 shows water surface profiles in the unlined RMC. The upper dash line is the full supply level, and the middle and the lower lines show water surface profiles after 1 and 4 days, respectively. The irrigation water arrives at the secondary 13L, although secondary canals located downstream of 11L are not scheduled to supply water. We can observe that the water surface is almost horizontal exhibiting weak back water effect. Especially in the case of the secondary canal located far from its immediate check gate, the water level is very low compared with its full supply level.

Intake flow rate and off-take discharges

Figure 5 shows time series of the intake flow rate and off-take discharges for 10 days; (a) and (b) correspond to major canals (RMC, 4L, 8L, and 13L), (c) and (d) to minor secondary canals (1L, 3L, 7L, and 9L), (a) and (c) to unlined canals, and (b) and (d) to lined canals. We realize the following facts. Flowing in the irrigation system attains the equilibrium of “static water distribution” within a relative early stage, that is, the intake flow rate

and off-take discharges become stable after about 2 days and are adjusted slightly later. The unlined canal requires higher flow rate than the lined canal. There is no water distribution to 13L to which water is not scheduled to divert.

Water supply to paddy field blocks

Figure 6 shows water supply to paddy field blocks belonging to the target reaches; (A1)–(A4) correspond to the unlined canal, and (B1)–(B4) to the lined canal. Label of RMC, 1L or 2L means the paddy field block to which water is supplied though the FTOs installed in the RMC, secondary canal 1L or 2L, respectively.

Water is supplied from upstream blocks sequentially. The lined canal can deliver water faster than the unlined canal. No blocks can get the scheduled amount of water of 14.7 mm/day in the first day. As significant changes are not observed after the third day, the flow is considered to approach steady. At this stage, all target blocks should get the scheduled amount of water; however, some blocks belonging to the upstream RMC and secondary canals, 8L and 9L, cannot get enough water. The reason for both cases may be attributed to too low water level in the RMC. As for the blocks belonging to the upstream RMC, they are designed to take water through direct diversion FTOs. When the flow rate is low, the water level becomes low especially at the upstream RMC because of a large canal cross section. This makes it difficult for direct diversion FTOs to take water. As for the blocks belonging to 8L or 9L, the water deficit is caused by insufficient off-takes discharge. Off-takes of 8L and 9L cannot take scheduled discharge because of the weak back water effect in the RMC. The 8L off-take point is far from its immediate check gate. On the contrary, off-take 10L can take enough water because its

Fig. 4 Water surface profiles progressing along the RMC in unlined condition

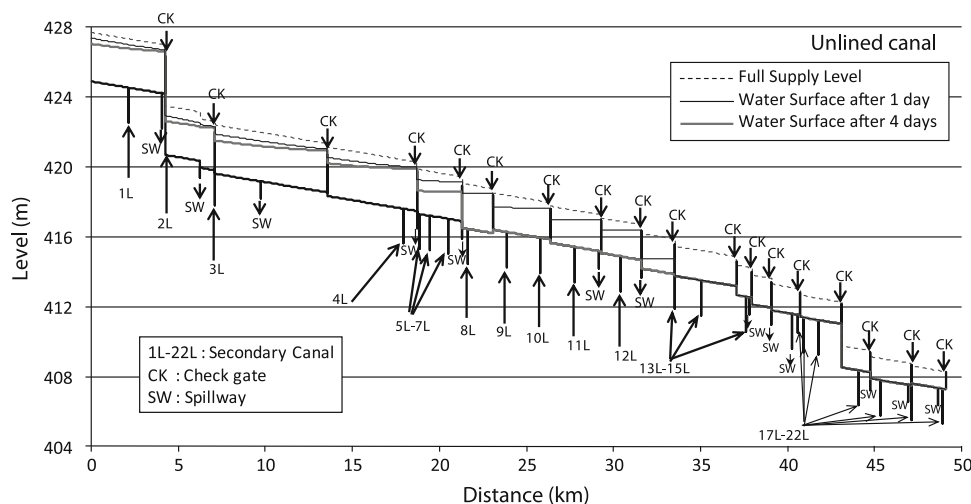

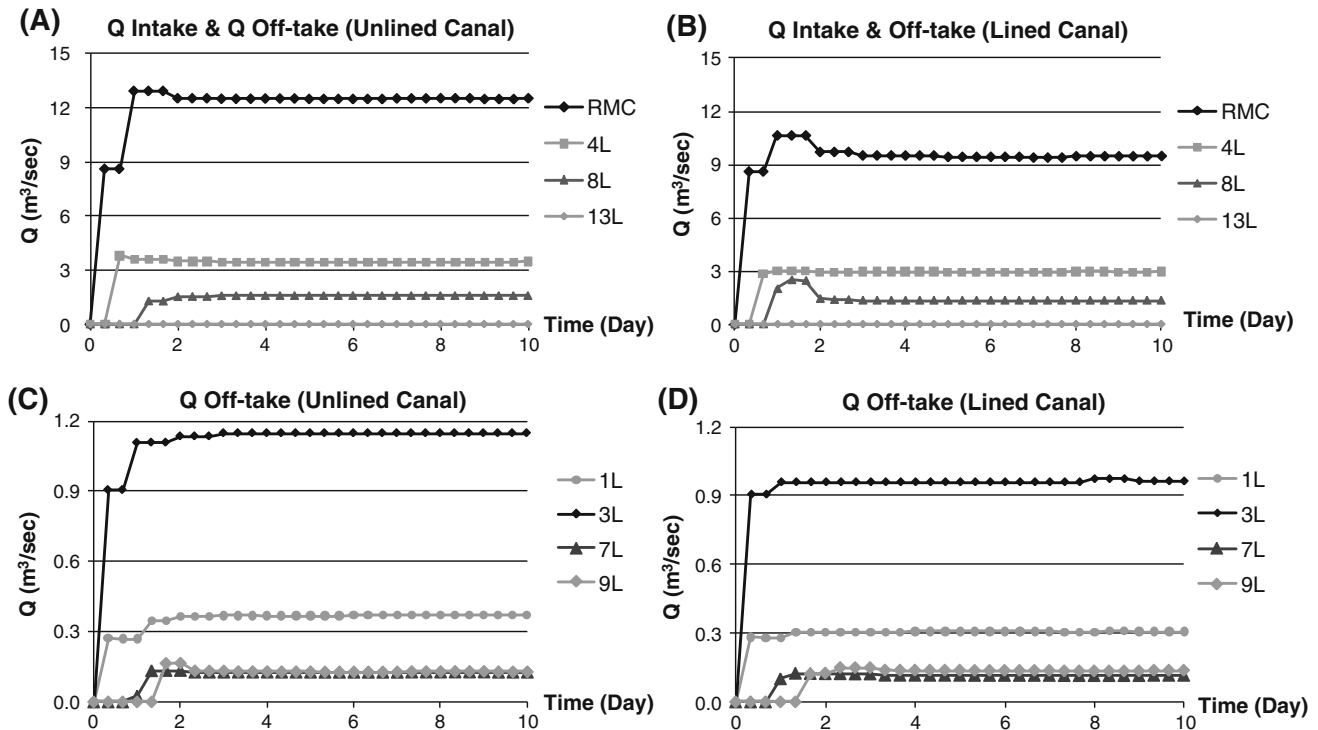

Fig. 5 Intake flow rate and off-take discharges for 10 days

diversion point is very close to the check gate as shown in Fig. 4.

For both the unlined and lined canals, the water distribution changes slightly after the third day. It means that the system needs more than 3 days to attain a static state. More target blocks of the unlined canal can get water than those of the lined canal. The main reasons are considered as follows. The unlined canal has a higher Manning's coefficient, and it also requires a higher intake flow rate to compensate seepage loss. These make the water level higher in the RMC and more water is diverted to these target blocks.

Considerations

Two indexes, the ERIA and PRIA, are first defined to diagnose the performance of the MLIS. The ERIA (Expected Ratio of Irrigable Area) is defined as a ratio of the expected irrigable area to the total area. This area may not get enough water because of several reasons; low water level, less or no water in the feeding canal, and ineffective spillage. However, such situation can be changed by constructing temporary weirs or installing vertical pumps in the canal. On the contrary, the PRIA (Present Ratio of Irrigable Area) is defined as a ratio of the present irrigable area to the total area. This area can be irrigated without additional efforts.

Figure 7 shows ERIA versus QIFR (inflow rate) and PRIA versus QIFR, when the gate gap is 0 mm (no leakage). Figures 7a and b correspond to the unlined canal and (c) and (d) to the lined canal. The dash line is the WR in paddy fields. Therefore, the horizontal distance between the dashed line and the other line distinguished by EQTY means the conveyance loss associated with canal seepage in case of (a) and (c), and the losses associated with canal seepage and ineffective spillage in case of (b) and (d).

In Fig. 7a and c, the line of EQTY = 1.00 is almost parallel with the dashed line, but the line of EQTY = 0.00 approaches to the dashed line with the smaller QIFR. It means that seepage loss does not change so much for all ranges of QIFR values when water is distributed equally to all areas, and the concentrative water delivery to upstream areas is economically advantageous when the inflow rate is small, especially for the unlined condition. On the other hand, by comparing Fig. 7a and b or c and d, the ineffective spillage is larger for smaller QIFR. The reason may be explained by the weaker backwater effect at smaller flow rate. The lower water level associated with weak backwater effect makes off-take gates and FTOs difficult to withdraw water and it increases the ineffective spillage. The ineffective spillage may be reduced by farmers' efforts. We had many chances to witness such efforts during field reconnaissance; water was lifted by vertical pumps, or canal flow was dammed up by logs and boards attached to

Fig. 6 Daily water supply to paddy field blocks

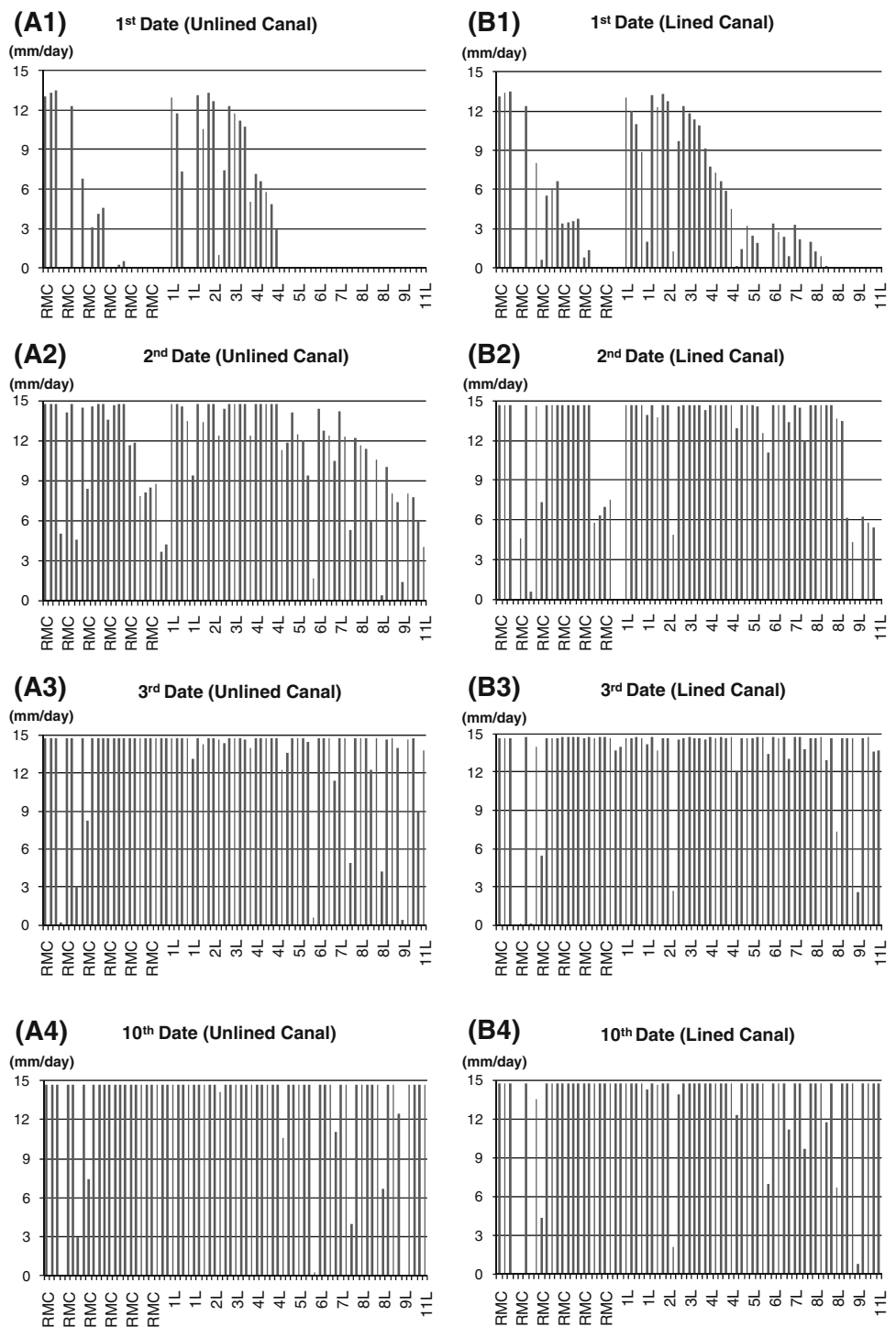

piers of bridge crossing the main canal. These activities are illegal, but are to some extent caused inevitably because of inappropriate structures and facilities.

Figure 8 shows the relation between Seep (whole seepage loss) and RRIS (Ratio of Reaches to be Irrigated in a Scheme), and Fig. 8a and b correspond to unlined and lined conditions, respectively. We can see that Seep

depends less on TIR, but rather depends more on RRIS, that is, on the spreading areas to be irrigated.

For given TIR and EQTY, Fig. 9 shows relation between Leak (whole leakage loss) and Gap (gate gap) which is considered to correspond to maintenance level. We can observe that Leak at the spillage gate increases in proportion to the Gap, and Leak also increases when higher

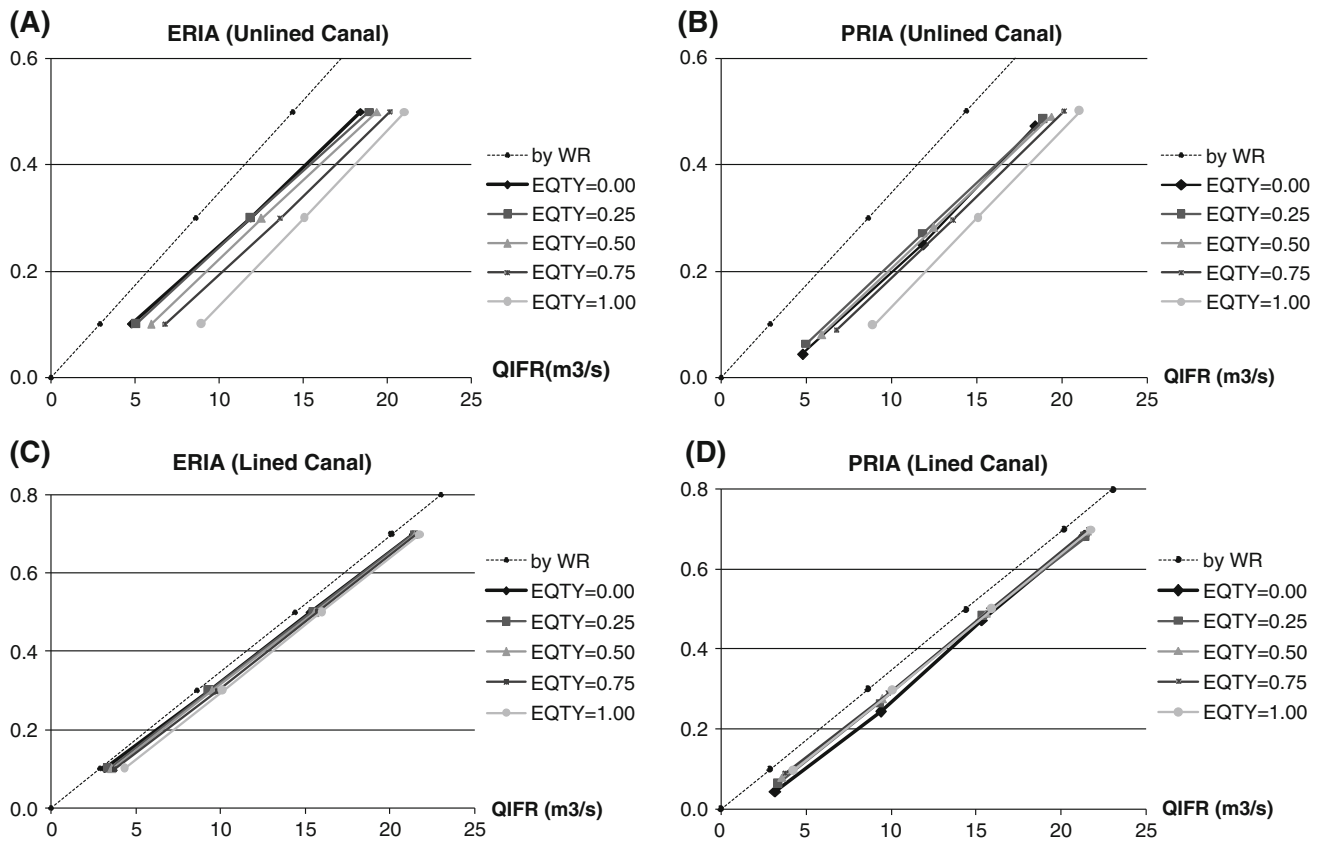

Fig. 7 Ratios of irrigable area versus intake flow rate (gate gap = 0 mm)

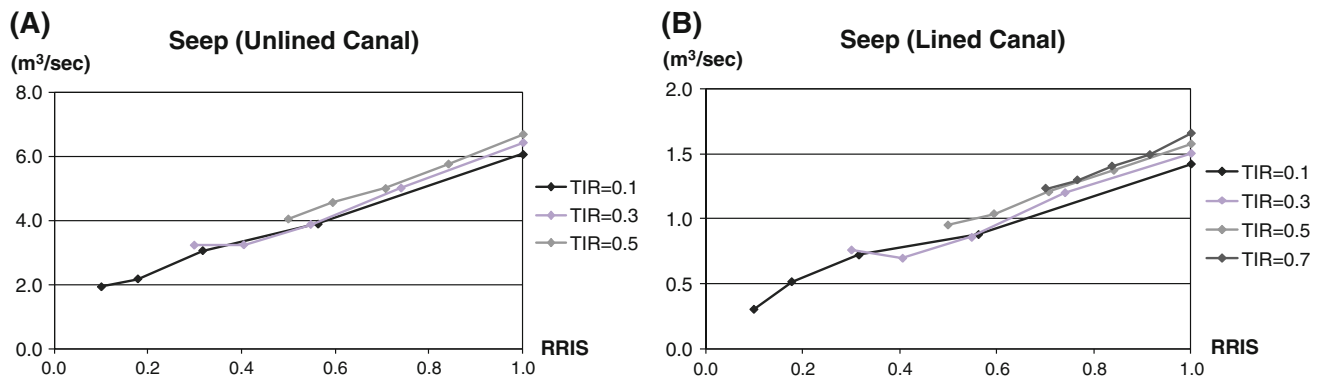

Fig. 8 Seepage loss versus ratio of reach to be irrigated a scheme

values are set for TIR and EQTY. However, Leak of the unlined canal is not significantly different from that of the lined canal.

Figure 10a–d show the breakdown of QIFR, that is, how and where water is consumed after it is taken at diversion weir. Parameters are TIR, EQTY, and canal surface conditions, lined or unlined. The maintenance level is fixed to very poor, that is, gate gap = 12 mm. Comparing the lined condition, Seep from the unlined canal is significant at high EQTY value when TIR is low, but is not so significant

when TIR is high. In the case of the lined canal, Seep is little against a wide range of EQTY and TIR values. This means that the fair water distribution can be facilitated by lining canals.

Ineffective spillage is significant at low EQTY value for both lined and unlined canals. This comes from the fact that some off-takes and the FTOs cannot withdraw enough water even if the scheduled amount of water is supplied to the irrigation system. This is caused by the structural feature of the MLIS. When the MLIS was designed since

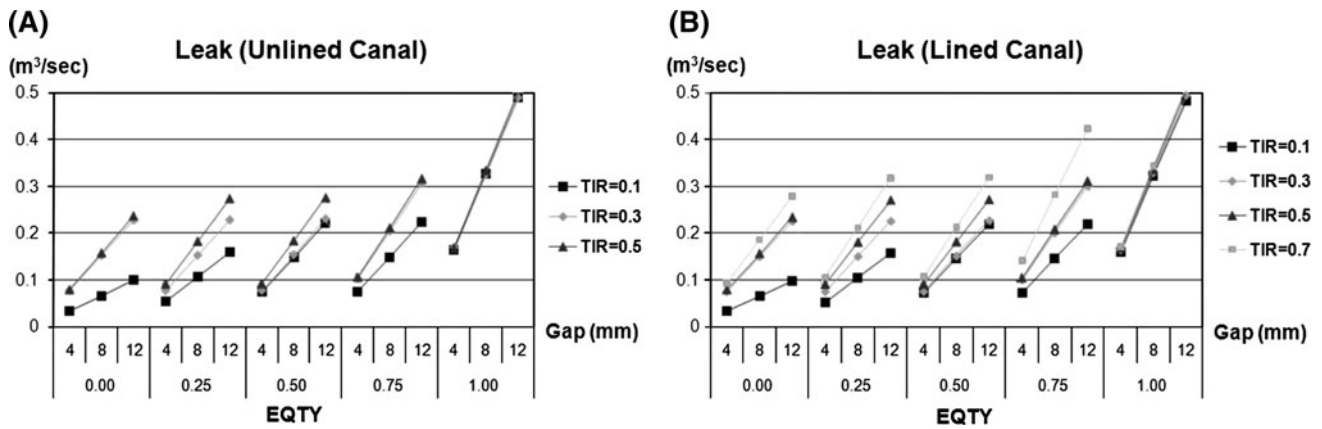

Fig. 9 Leakage loss versus maintenance levels for given TIR and EQTY

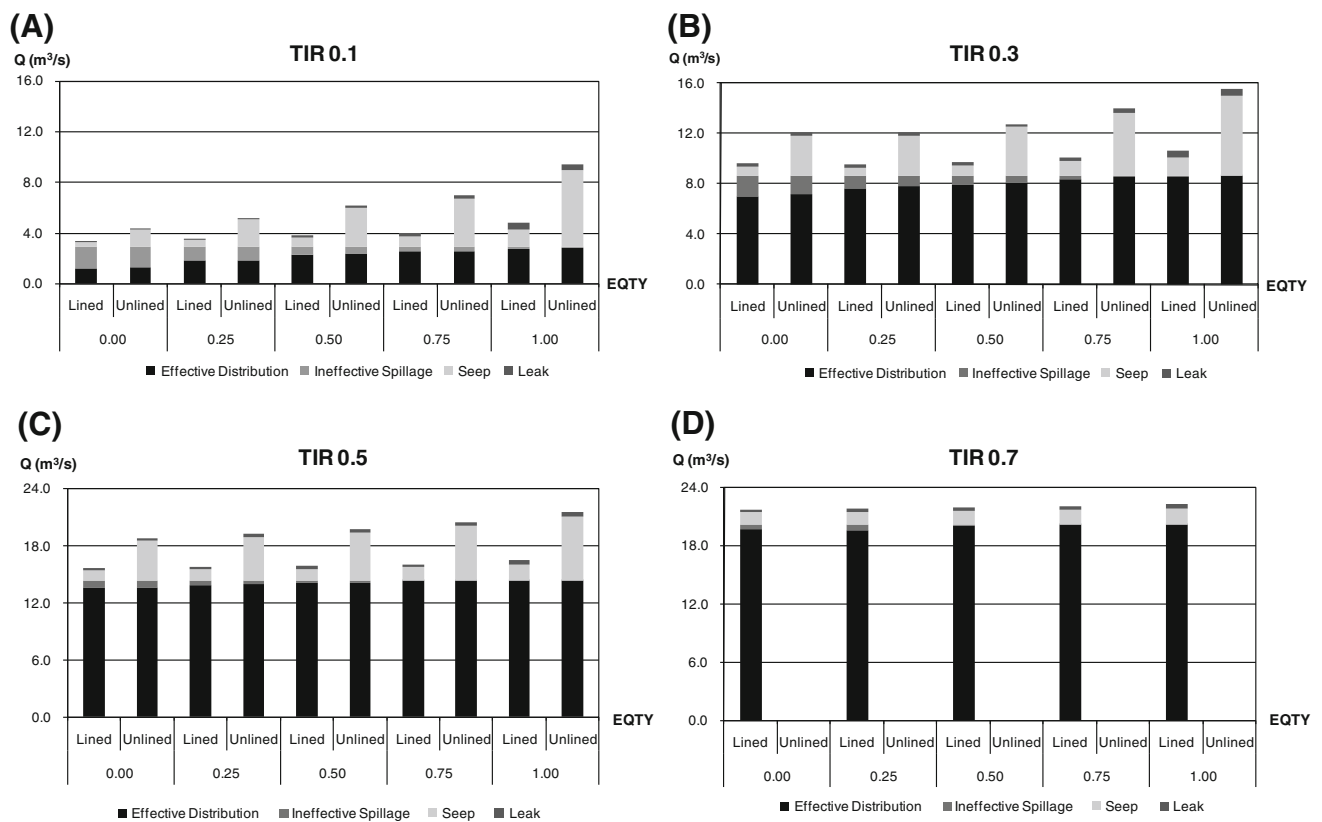

Fig. 10 Breakdown of QIFR into effective distribution, ineffective spillage, seep, and leak when gate gap = 12 mm

1950, designers might have assumed only continuous irrigation during the rainy season with sufficient water. If it is true, sill elevations of off-takes and FTOs might be decided based on the full supply level and off-take points might be decided regardless of the distance from their immediate check gate. As for the Leak, it increases for higher TIR and EQTY values, but no significant difference can be observed between lined and unlined conditions, as mentioned before. All these features are derived from the physical properties of the MLIS.

Conclusions

Through this study, the following facts are found and made clear.

- (1) The UIWDC model has a capability to compute outputs qualitatively different from those calculated by a simple water balance model. In this study, this model was applied to the MLIS to analyze static water distribution using the unsteady flow simulation.

As a result, the whole transient process was followed until equilibrium was achieved, and it, for example, provided the time needed for a steady state.

- (2) Using two indexes of ERIA and PRIA, the MLIS was diagnosed and it was concluded that one of main causes of uneven water distribution originated from the physical structure of the MLIS itself. The MLIS was presumably designed for continuous irrigation during the rainy season. Therefore, the structure and facilities are not well fitted to dry season irrigation activities, where flow rate is small and the water level is much lower than the full supply level, especially at locations far upstream from the check structure.
- (3) By introducing the EQTY index, the balance of two effects, that is, equal water distribution and effective water use, could be examined systematically and continuously. If both effects are quantitatively measured or qualified, this balance problem can be transformed into an optimal problem.
- (4) Seepage loss in the unlined canal is significant if water is distributed equally when water is scarce. However, seepage loss can be reduced significantly by lining canals. It means the lined canal system has a potential to distribute water equally without losing much water, which is a major obstacle for equal water distribution.
- (5) Leakage losses from spillways are not significant compared to other losses, as long as the maximum gate gap is 12 mm, which was considered to represent very poor maintenance level.

Open Access This article is distributed under the terms of the Creative Commons Attribution Noncommercial License which permits any noncommercial use, distribution, and reproduction in any medium, provided the original author(s) and source are credited.

References

- Akkuzu E, Unal HB, Karatas BS (2006) Determination of water conveyance loss in the Menemen open canal irrigation network. *Turk J Agric For* 31:11–22
- Alam MM, Bhutta MN (2004) Comparative evaluation of canal seepage investigation techniques. *Agric Water Manag* 66:65–76
- Allen RG, Pereira LS, Raes D, Smith M (2007) Modernizing irrigation management—the MASSCOTE approach mapping system and services for canal operation techniques, irrigation and drainage, vol 63. FAO, Rome, pp 53–55
- Chow VT (1959) *Open-channel hydraulic*. McGraw-Hill, New York, pp 116–120
- Marten GG (1986) *Traditional agriculture in Southeast Asia: a human ecology perspective*. Westview Press, Boulder, CO, pp 6–12
- Royal Irrigation Department (1999) *Report of The feasibility study and design detail for improving 5 irrigation projects*, Bangkok, Thailand
- Royal Irrigation Department (2003) *The Final Report of The constructing Concrete Dam, Mae Suai Project*, Chiang Rai Province, Bangkok, Thailand
- Sagardoy JA, Bottrall A, Uittenbogaard GO (1986) *Organization, operation and maintenance of irrigation schemes*, Irrigation and Drainage. FAO, Rome, p 40
- Skogerboe GV, Merkle GP (1996) *Irrigation maintenance and operations learning process*. Water Resources Publications LLC, Highlands Ranch, pp 255–263
- Watanabe T (1999) *Irrigation water requirement, advanced paddy field engineering*, Editorial Committee of Advanced Paddy Field Engineering (JSIDRE), SHIZA-SHA Sci. & Tech. Publishing Co. Ltd., pp 31–50
- Wongtragoon U, Kubo N, Tanji H (2009) *Performance diagnosis of Mae Lao Irrigation Scheme in Thailand. (I) Development of unsteady irrigation water distribution and consumption model*. *Paddy Water Environ* 8(1):1–13
- Xie M, Kuffner U, Le Moigne G (1993) *Using water efficiently: technological options*. World Bank Technical, Washington, DC, p 205