



COMPASSO mission and its iodine clock: outline of the clock design

Frederik Kuschewski¹ · Jan Wüst² · Markus Oswald^{1,3} · Tim Blomberg¹ · Martin Gohlke⁴ · Jonas Bischof¹ · Alex Boac¹ · Tasmim Alam¹ · André Bußmeier¹ · Klaus Abich¹ · Niklas Röder¹ · Klaus Döringshoff^{5,6} · Jan Hrabina⁷ · Miroslava Holá⁷ · Jindřich Oulehla⁷ · Thilo Schuldt¹ · Claus Braxmaier^{1,2}

Received: 25 April 2023 / Accepted: 24 September 2023 / Published online: 18 October 2023
© The Author(s) 2023

Abstract

One of the limiting factors for GNSS geolocation capabilities is the clock technology deployed on the satellites and the knowledge of the satellite position. Consequently, there are numerous ongoing efforts to improve the stability of space-deployable clocks for next-generation GNSS. The COMPASSO mission is a German Aerospace Center (DLR) project to demonstrate high-performance quantum optical technologies in space with two laser-based absolute frequency references, a frequency comb and a laser communication and ranging terminal establishing a link with the ground station located in Oberpfaffenhofen, Germany. A successful mission will strongly improve the timing stability of space-deployable clocks, demonstrate time transfer between different clocks and allow for ranging in the mm-range. Thus, the technology is a strong candidate for future GNSS satellite clocks and offers possibilities for novel satellite system architectures and can improve the performance of scientific instruments as well. The COMPASSO payload will be delivered to the international space station in 2025 for a mission time of 2 years. In this article, we will highlight the key systems and functionalities of COMPASSO, with the focus set to the absolute frequency references.

Keywords COMPASSO · GNSS · Galileo · Optical clock · Modulation transfer spectroscopy · Absolute frequency reference

Introduction

State-of-the-art high-precision frequency references such as clocks addressing atomic transitions or cavities are essential tools for many fields of research both in laboratory environments and for space applications such as geodesy (Abich 2019), relativity theory (Takamoto 2020; Herrmann 2018; Delva 2019; Ushijima 2015) and navigation with the Global Navigation Satellite System (GNSS) network. While atomic lattice clocks have reached lowest frequency instabilities in the range of 10^{-18} at a 10,000 s timescale (Takamoto 2020; McGrew 2018), these clocks suffer from a big footprint, power usage and complexity. The smaller, established microwave clocks utilized for spaceborne application, however, show orders of magnitude lower performance, limiting the accuracy of possible geolocation via GNSS. To improve the performance of future GNSS and its architectures as well as other applications, a general technology development roadmap has been laid out by the European Space Agency (ESA) promoting the evolution of alternative clock technologies (ESA 2019) such as optical clocks toward space-grade

✉ Frederik Kuschewski
frederik.kuschewski@dlr.de

¹ German Aerospace Center, Institute of Quantum Technologies, 89081 Ulm, Germany
² Institute of Microelectronics, Ulm University, 89081 Ulm, Germany
³ Center of Applied Space Technology and Microgravity (ZARM), University of Bremen, Bremen, Germany
⁴ German Aerospace Center, Institute of Space Systems, 28359 Bremen, Germany
⁵ Institute of Physics, Humboldt University Berlin, 10099 Berlin, Germany
⁶ Ferdinand-Braun-Institut (FBH), Gustav-Kirchhoff-Straße 4, 12489 Berlin, Germany
⁷ Institute of Scientific Instruments, Czech Academy of Sciences, 61264 Brno, Czech Republic

quality. Apart from a superior clock stability, the improvement of the technology readiness level (TRL) (Mankins 2004), the reduction of size, weight and power requirements (SWaP) as well as a long lifetime in space environment are in the scope of ESA.

Today's timing standards for GALILEO satellites are rubidium atomic frequency standards (RAFS) and passive hydrogen masers (PHM) (Droz 2006; Droz 2008). While both technologies cannot compete with other frequency standards in short-term stability, they reach decent long-term performance as depicted in Fig. 1. Given the technical maturity of both these standards, a significant improvement in the geolocation performance on GALILEO/GNSS satellites can only be achieved with the implementation of new technologies, since one limiting factor is the stability of the clocks. Active hydrogen masers in combination with laser-cooled cesium clocks are foreseen to be tested on the ESA ACES (Atomic Clock Ensemble in Space) mission (Cacciapuoti 2017). A mercury ion clock developed by NASA/JPL (Hoang 2019; Burt 2021) has been tested successfully in orbit for 1 year and has the potential to improve the performance of RAFS and PHM by an order of magnitude with further optimization.

Other promising approaches taking compactness, low power usage and weight into account, are optical clocks based on laser technologies such as Doppler-free modulation transfer spectroscopy (MTS) with one single (Schuldt 2017; Zhang 2017) or two photons (Martin 2018) addressing the atomic transition. As depicted in Fig. 1, a flight-like MTS setup addressing a rovibronic transition in molecular iodine can reach the 10^{-15} to 10^{-14} level up to around 10^4 s. Please note the beat measurement of the MTS is referenced to an optical cavity and hence the long-term stability is limited by the cavity and not the iodine MTS. The SWaP of the above-mentioned established GNSS systems as well as next-generation candidates are shown in Table 1.

Further approaches are thermal beam optical clocks (Shang 2017) and optical lattice clocks (Origlia 2018). While the above-mentioned laser-based technologies have reached relative frequency stabilities in the range of 10^{-13} down to impressive 10^{-18} for different integration times (see overview table in Schuldt 2021) in ground-based experiments, the functionality has not been demonstrated for in-orbit operation. SWaP as well as the TRL (Mankins 2004) are far from a state needed for long-term operation on a satellite. For the sake of completeness, the performance of

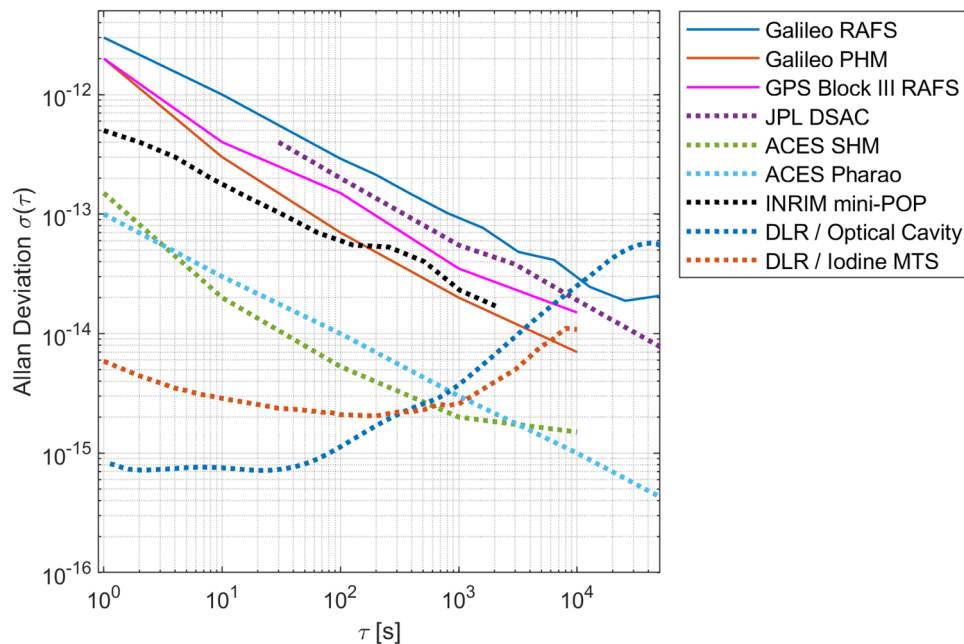

Fig. 1 Overview of state-of-the-art clock technologies for space application given as Allan deviation. Solid lines show operational clocks on GNSS satellites. Dashed lines show next-generation clocks for space application. The Galileo Rubidium Atomic Frequency Standard (RAFS) and Passive Hydrogen Maser (PHM), the GPS Block III RAFS, the Atomic Clock Ensemble in Space (ACES) consisting of an active hydrogen maser (SHM) and a laser-cooled cesium clock (Phrao), the Jet Propulsion Laboratory (JPL, USA) laser-cooled mercury clock and the INRIM (Italy) mini-POP clock

are microwave references showing stabilities of $>10^{-13}$ for integration times of 1 s and can reach performances in the 10^{-15} range for an integration time of 10,000 s. Optical cavities developed by DLR show very high stability in the 10^{-16} range for integration times on the minute timescale, however, are prone to thermal influences and hence lack long-term stability. DLR iodine optical clocks utilizing modulation transfer spectroscopy (MTS) show performances in the 10^{-15} range for integration times up to around 10^4 s

Table 1 SWaP of GNSS clock standards and some candidates for next-generation GNSS

	Volume (l)	Weight (kg)	Power (W)	Source
Galileo RAFS	3.2	3.4	35	Orolia datasheet
Galileo PHM	26.3	18.2	60	Leonardo datasheet
GPS III	4.1	6.35	39	Excelitas datasheet
ACES SHM	90	45	n/a	Laurent (2015)
ACES Pharao	900 mm length	90	110	Laurent (2015)
INRIM	16.8	9	40	Micalizio (2021)
DLR Iodine MTS (COMPASSO IR incl. frequency comb)	46	32	120	

ultra-stable optical cavities is shown in Fig. 1 as well. These frequency references show very good short-term performance and are successfully applied in space (e.g., GRACE Follow-On, Abich 2019). However, they are inherently not absolute frequency references, are prone to temperature changes and hence lack reproducibility as well as long-term stability.

COMPASSO mission

The COMPASSO mission (Schmidt 2022; Schmidt 2023) is a DLR-funded in-orbit verification mission with the goal of demonstrating the capabilities of high-performance quantum optical technologies in space, specifically on the ArgUS multi-payload adapter of the BARTOLOMEO platform (Airbus 2022) on the International Space Station (ISS). It is led by the Galileo Competence Center of the German Aerospace Center (DLR-GK) working in close collaboration with the DLR Institutes and industry partners. The key technology systems of the mission are two iodine frequency references, a frequency comb and a laser communication and ranging terminal (LCRT). The goals of the mission are of technical and scientific nature. Primary goals cover the demonstration of key technologies in space and the evaluation of their performance, via the measurement of optical frequency stability via beat signals between the subsystems, e.g., two iodine references and the comb locked to the GNSS-disciplined oven-controlled crystal oscillator (OCXO). It is also foreseen to establish an optical link between the ISS and the ground station. Secondary goals cover the accomplishment of long-time operation with high performance and the transfer of frequency and timing information via the LCRT. The link will allow for the comparison of the payload's frequency to a similar reference located at the ground station. The optical link will also exchange timing information and yield an absolute distance measurement between the ISS and the ground station. Tertiary goals cover scientific questions and the achievement of performances required by future flagship space missions. Firstly, the COMPASSO mission will be capable of measuring the gravitational redshift the payload will experience due to lower gravitational potential in the

Table 2 COMPASSO iodine reference performance goals for short- and long-term stability.

COMPASSO	Short-term stability	Long-term stability
Primary goals	$5 * 10^{-12}$ @ 1 s	$5 * 10^{-14}$ @ 10,000 s
Secondary goals	$3 * 10^{-12}/\sqrt{(\tau)}$ for $1 \text{ s} < \tau < 100,000 \text{ s}$	10^{-14} @ 1,000,000 s

The goals are based on current Galileo clock technology

LEO. Secondly, the performance of the frequency stability shall be within the requirements for the Laser Interferometer Space Antenna (LISA, Dahl 2019; ESA 2022) and Next Generation Gravity Missions (NGGM, Haagsmans 2020). The requirements are shown in Table 2. A successful mission could pave the pathway to replace or back-up the rubidium clocks and masers of the next-generation GALILEO satellites. The long-term vision is the deployment of the COMPASSO technology for the proposed DLR mission KEPLER (Glaser 2020), which is a GNSS constellation employing cavities and optical clocks being synchronized via optical links in LEO and MEO orbits.

The COMPASSO project was started with the formal kick-off meeting at the beginning of 2021. The development of the different model stages is planned for 4 years, leading to the start of the mission in 2025. After successful delivery to the ISS, the payload will be unpacked by a trained astronaut and attached to the ArgUS multi-payload adapter via the ISS robotic arm. The activation phase is planned for 1–3 days and covers the first start-up of the system in space. When basic functionalities are confirmed, a 1-month commissioning phase is foreseen. All subsystems will be thoroughly tested, and their performances will be analyzed. The optical link will be established for the first time. In the subsequent 1.5 years long operation phase, the system will run at full functionality and the data needed to fulfill the mission goals is collected. Finally, the payload will be returned to DLR for further analysis roughly 2 years after launch.

A functional block diagram of the key systems of the mission is shown in Fig. 2. Two identical iodine references (IR 1 and IR 2) are implemented into the system for

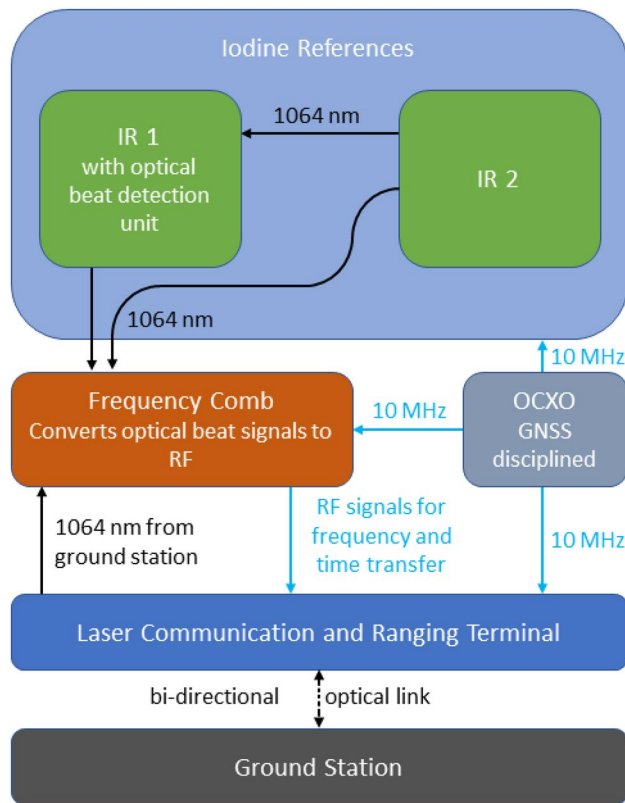

Fig. 2 Functional block diagram of the key systems of the COMPASSO payload, covering the iodine references (IR), the frequency comb (FC), the oven-controlled crystal oscillator (OCXO), the laser communication and ranging terminal (LCRT) and the ground station. Fiber-optical connections are indicated by black arrows, the free-space optical connection by the dashed black arrow, the RF connections in blue

two reasons: Firstly, the iodine references are expected to outperform the other frequency references onboard the COMPASSO mission, and hence, the performance is best assessed by a beat measurement of two such identical systems. Secondly, the functionality of the overall system is still given if one of the IRs fails. The IRs are utilized as absolute frequency references with a frequency of around 563.26 THz and can be locked independently via a frequency-doubled ECDL and MTS to any of the 15 hyper-fine components of the rovibronic transition $R(56)32-0$ of molecular iodine near 532 nm (see next section for a schematic overview of the frequency locking technique). The ensemble is spanning over a range of 858 MHz (Arie 1994) with a natural linewidth of each transition around 300 kHz. The absolute frequency of the a_{10} line has been determined with an accuracy of around 1 kHz (Nevsky 2002), and the locking reproducibility of MTS is in the same range (Döringshoff 2017; Hong 2004). The frequency offset and the stability of the two units are measured with a beat detection unit (BDU) in IR 1. The beat signal is passed to a

frequency counter yielding the frequency stability between both IRs. Since a frequency accuracy on the Hz level is enough to evaluate the optical beat frequency, performance requirements of the frequency counter are very moderate, especially when the two IRs are locked to the same transition and a kHz beat is expected. A fraction of the laser is also passed to a frequency comb (FC), which can be locked to either one of the iodine references and transfers its stability from the optical to the RF range. The RF signals are passed to a frequency counter, hence making each IR in combination with the comb a fully functioning clock, by comparing the optical stabilized RF signal to an onboard GNSS-disciplined OCXO. It is expected that the OCXO limits the performance verification of the Iodine Clock; however, the long-term frequency stability of the iodine clock can be evaluated without common-mode effects both IRs could experience due to similar environment. Since the frequency comb also receives the 1064 nm signal emitted from an iodine reference located at the ground station (Oberpfaffenhofen, Germany) via the LCRT, it can directly compare the frequencies of the IRs in space and the one on ground level.

Within the COMPASSO mission, tailored ECSS guidelines are followed for the development toward the flight model. The overall system is developed step by step with a breadboard model (BBM), a development model (DM) a proto-flight model (PFM) and a flight model (FM). Within the iodine reference, we slightly deviate from the usual model philosophy mainly due to several components with very long lead times and due to rather low space maturity of the corresponding technologies. To ensure the completion of the (P)FMs within the given timeframe, we built several laboratory-grade BBMs, which will be followed by an engineering model (EM), a structural-thermal model (STM), and a (P)FM. With the BBMs, the general design is tested for functionality. They offer the possibility for optimization as most parts are accessible and can be exchanged for testing purposes. Once the development is finished, the BBMs can be used as a characterized frequency reference to test the performance of the EM or the (P)FM. Furthermore, one BBM is used to test the control electronics of the flight models. The EM will have the form, fit and function of the final model, but will not undergo the qualification process needed for space. The STM will also have the same form and fit and will be tested for environmental influences with thermal cycling and vibration tests. However, some components will be replaced with mass dummies within the STM, such as the ECDL and the fiber-optical components of the laser system and also the printed circuit boards (PCBs) within the control electronics. The qualification of these components will be done on component level with a number of parts being qualified by the manufacturers to the standards needed for the ISS orbit. The final flight models will be developed by

an industry partner where the PFM will undergo a qualification test campaign and the FM an acceptance test campaign.

The frequency comb is supplied by Menlo Systems GmbH. The LCRT is supplied by Tesat GmbH with ranging functionality developed by the DLR Institute for Communication and Navigation (DLR-KN). The BARTOLOMEO platform is operated by Airbus. Based on previous mission ideas and projects (Braxmaier 2010; Schuldt 2015; Gürlebeck 2018; Schuldt 2019), the DLR Institute of Quantum Technologies (DLR-QT) is the scientific innovator and is developing the iodine references with the control electronics supplied by SpaceTech GmbH. The laser source is supplied by Ferdinand-Braun-Institute. The Institute of Scientific Instruments of the Czech Academy of Sciences (ISI Brno) develops the iodine gas cells and the DLR Institute for Optical Sensor Systems (DLR-OS) the photodetectors for the iodine references. Other DLR institutes involved are the Institute for Space Operations and Astronaut Training (DLR-RB) for mission control and the Institute for Software Technology (DLR-SC) for flight software.

Laser system stabilization and control

Generally, MTS (Ito 2000) is probing the hyperfine transitions of rovibronic states of a gas and is frequently used for laser stabilization of quantum clocks and for quantum sensors. Many of such transitions exist in atoms and molecules (see the schematic drawing in Fig. 3a), and the choice of a line depends on the desired application, availability of

narrow-band laser sources, the linewidth of the transition and other factors. Since suitable laser sources are usually addressing transitions of lower orbitals, the transition energy is very insensitive to environmental influences. With a linewidth of a line in iodine in the range of around 300 kHz in case of molecular iodine (Arie 1994), the Doppler-broadening in the Maxwell–Boltzmann-distributed gas is orders of magnitude larger and needs to be eliminated by the use of counter pump and probe beams as depicted in Fig. 3b. The strong pump beam burns a so-called Bennett-hole into the velocity distribution of the gas (Fig. 3c), lowering the absorption of the probe at this frequency. Since the probe beam is counter-propagating, only molecules moving perpendicular to the beams can be addressed by pump and probe at the same time, hence eliminating the Doppler-broadening. Similar to the Pound–Drever–Hall laser stabilization technique (Drever 1983) for optical cavities, by phase-modulating the pump beam and demodulating at the same frequency, a steep signal as depicted in Fig. 3d is created and used for frequency locking.

While the most stable frequency references based on molecular iodine (Schuldt 2017; Döringshoff 2017; Cheng 2021; Zang 2007) are set up with free-space optics laser manipulation and distribution, this approach cannot be followed for the COMPASSO mission due to its excessive size and weight. Hence, all light at 1064 nm is distributed via polarization-maintaining optical fibers and only after second-harmonic generation and beam delivery via a 532 nm fiber to the spectroscopy board, free-space optics are used

Fig. 3 MTS overview and signal generation. **a** Schematic overview of rovibronic energy levels in atoms and molecules. Each transition is split into many hyperfine levels which are probed in MTS. **b** Counter-propagating pump and probe beams are exciting the states and probing the population of the gas atoms/molecules (black dots). The molecules show a Maxwell–Boltzmann velocity distribution. **c** The absorption of a Doppler-broadened hyperfine transition (solid line) of a transition with the frequency ω_0 and a reduced absorption profile (dashed line) due to a strong pump beam changing the population of the ground state. **d** Demodulated MTS signal. The steep line is used for frequency locking at ω_0

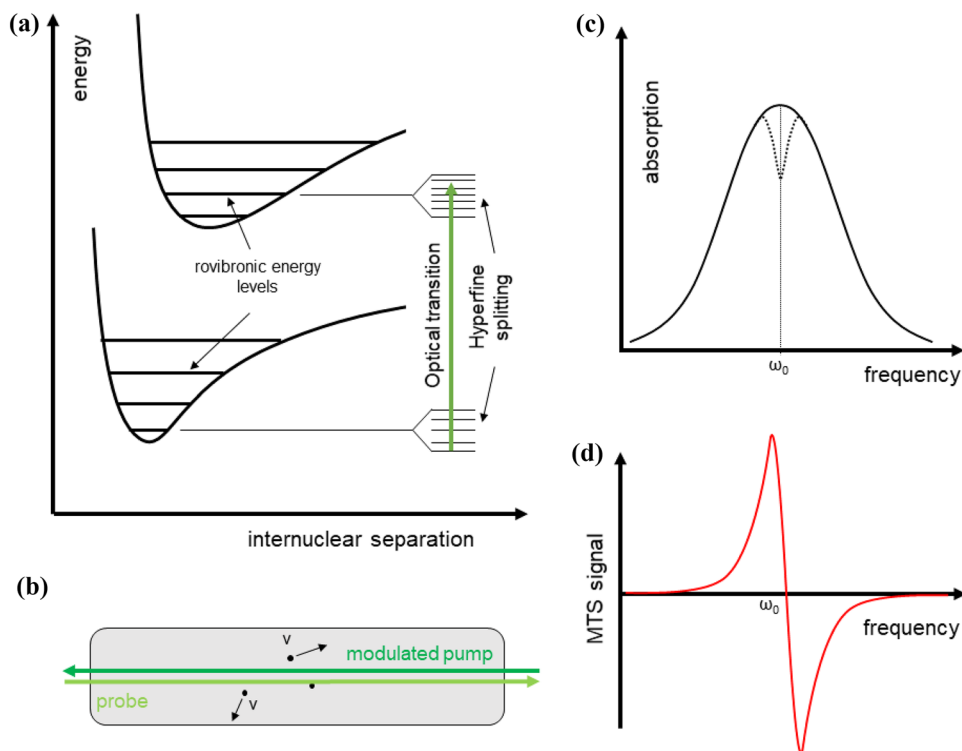

to create the iodine MTS signal. A reduced overview of the laser-optical systems (LOS) and the iodine spectroscopy for the COMPASSO mission is illustrated in Fig. 4, including the control loops required to achieve a stable and high-performance frequency lock.

The ECDL (Ferdinand-Braun-Institut, Kürbis 2020) is emitting around 500 mW of narrow-band laser light at a frequency of around 282.63 THz (1064 nm, linewidth few 10 kHz) and can be tuned without mode hop by roughly 6 GHz. An optical isolator prevents parasitic return light to reach the laser source. A fiber splitting unit consisting of three splitters is distributing ~70% of the input light toward the pump chain and ~28.5% into the probe chain. Around 1.5% of the beam are distributed equally to the FC and the beat detection unit. The acousto-optical modulators (AOMs) are driven with 140 MHz and allow for fast power control of pump and probe beams. The first-order AOM also shifts the frequency of the beam, pushing spurious interference effects between pump and probe beam out of the bandwidth of the detectors, an essential procedure for improved performance of Doppler-free MTS. The pump beam is phase modulated with an electro-optical modulator (EOM) at a frequency of 280 kHz for MTS. Both, pump and probe beam, are each frequency-doubled with a dedicated second-harmonic generation (SHG) waveguide module, each temperature-stabilized for maximum conversion efficiency. The minimal expected power levels for pump and probe beams are 10 mW and 3 mW, respectively. The iodine spectroscopy unit (details of the optics and optomechanics are discussed below) contains three photodetectors for the detection of the optical signals. A noise-cancelling (NC) detector using a balanced detection

scheme is deducing the MTS signal of the probe beam at the modulation frequency (Hobbs 1997), while another DC detector is measuring the probe power level. The pump beam is detected with one detector, delivering on the one hand the pump power and on the other hand the residual amplitude modulation induced by the EOM to the beam. All detector signals are processed by the iodine control electronics and distributed to PID controllers. The laser frequency is stabilized to the MTS signal with a fast control loop via the laser driving current within one laser mode (few GHz) and can additionally be changed via the temperature control of the laser. The optical power of the pump and the probe beam is stabilized to the PD signals via the AOMs. Stabilization of the optical power is crucial since the optical power affects the frequency of the iodine reference, e.g., via the AC Stark effect. Slower changes in the power (e.g., through degradation of the ECDL) are adjusted when the user requests it via telecommand. The RAM feedback is realized by a DC offset to the modulation voltage at the EOM to minimize residual amplitude modulation (Whittaker 1985; Li 2012) occurring in MTS setups using EOMs (Jaatinen 2008). This control loop is required to ensure long-term stability of iodine clocks (Whittaker 1985; Jaatinen 1998, 2008; Li 2012). For additional power level monitoring, six tap photodiodes are included at various locations within the system. Both iodine references of the COMPASSO mission are exactly the same apart from the beat detection unit, which is only included in IR1 (see Fig. 2) and measures the optical beat signal at 1064 nm between both references yielding the stability of the setups with a frequency counter. Apart from the functionalities needed for a stable laser locking to the

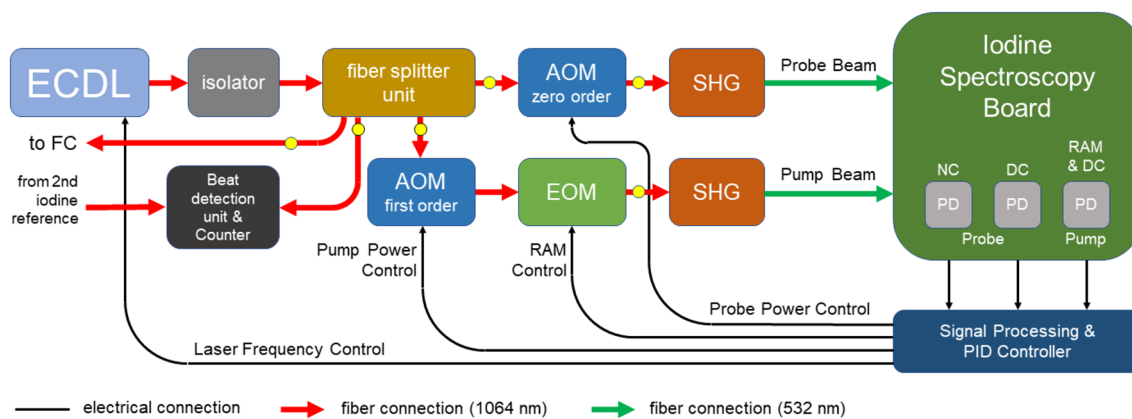

Fig. 4 Overview of the laser-optical system (LOS) of IR1 and the iodine spectroscopy board, reduced to the elements required for beam distribution and laser feedback control. Fiber connections for 1064 nm and 532 nm light are indicated with red and green arrows, respectively. The power levels in the LOS are measured in situ by tap photodiodes (yellow dots). The LOS passes a part of the light to the frequency comb (FC) and receives a fraction of light by laser-optical system of IR2 for beat detection in the beat detection unit (BDU).

The signal levels inside the iodine spectroscopy board are obtained with three photodetectors (PD). The probe beam is detected with a DC detector to check the power level and a noise-cancelling (NC) detector measuring the MTS signal. A third PD is used to measure the pump power level and the residual amplitude modulation (RAM) in the pump beam. All PD signals are analyzed and passed to a PID control to stabilize the LOS

transitions in iodine, the electronics control the temperatures of the SHGs and the iodine spectroscopy board, which is located inside a thermal shield to minimize environmental influences.

The electronics collect housekeeping data which is available via telemetry (TM) during the mission. The beat frequency is available with a sampling rate of 10 Hz. All other housekeeping data are sampled with 1 Hz, such as the laser driving currents and the frequency lock PID output parameters, the laser temperatures, the power levels at the tap photodiodes, PID output parameters for power and RAM stabilization, the SHG temperatures and the thermal shield temperature. This dataset will allow for proper monitoring and performance analysis of the iodine references during the mission. The whole LOS can be turned on and off during the mission via telecommand (TC). When the system is running, the relevant parameters for the MTS performance can be adjusted to desired values, such as the laser currents and temperatures, the SHG and heat shield temperatures, the power set points in the LOS, the AOM RF powers, the EOM modulation parameters (amplitude, frequency and phase) and the frequency lock set point. All PID control loop parameters of the system can be changed via TC as well.

Integrated MTS spectroscopy board

The iodine spectroscopy board is based on heritage of previous projects (Schuldt 2017; Gohlke 2015; Döringshoff 2017) and is a slight variation of the spectroscopy board of the ADVANTAGE project which developed iodine MTS to flight level TRL. All optics and optomechanics are hosted on a Zerodur optical bench with extremely low thermal expansion (CTE $\sim 10^{-8}/\text{K}$) and fixed with adhesive bonding to achieve the rigidity needed for spaceflight (Ressel 2010). The board has a size of 300 mm \times 150 mm \times 35 mm and has a honeycomb structure milled into the body from below to save weight. Including the optical components, an overall mass of 3.25 kg is estimated. The cell filled with iodine gas has a length of 20 cm. A top view of the CAD model of the board and the integrated EM board is shown in Fig. 5. Generally, in MTS (Ito 2000), pump and probe beam are counter-propagating through the gas, virtually eliminating the Doppler background. Please note that we employ a crossed-polarized beam distribution scheme. The use of polarization-sensitive optics hence allows for efficient distribution and dumping of the beams. The pump and probe beams are indicated in dark and light green, respectively, and are coupled in via fiber collimators, which are held by purpose-designed titanium holders. The probe beam is passing a polarizer, a $\lambda/2$ wave plate (HWP, mounted in purpose-made titanium holders) and a thin-film polarizer (TFP) allowing for the adjustment of the

power level at the first PD of the noise-cancelling detector (NC). A second pair of HWP and TFP is used to adjust the probe power in the gas cell (ISI Brno), which is measured via the reflection on a beamsplitter with a DC detector. The cell is enclosed in a housing made of mu-metal to minimize the influences of magnetic fields (roughly 25 Hz/G, expected change in the ISS orbit is below 1 G) on the measurement. Using retroreflectors, the beam is guided in a four-pass configuration through the cell leading to an effective interaction length of 80 cm before it is steered again to a TFP. It is then detected in the second PD of the NC detector, where both reference and MTS signal are subtracted from each other, effectively suppressing intensity noise in the probe beam. The pump beam is guided to a beamsplitter (BS), picking off a part of the beam and sending it to an integrated detector used to measure the pump power and the residual amplitude modulation (DC and RAM) of the pump beam. The pump beam is counter-propagating the probe beampath and is dumped after the cell by the polarization-sensitive optics. To maximize the signals on the detectors, lenses in titanium holders are used. The board itself is fixed with titanium feet glued to the side of the Zerodur board and fixed with screws to an aluminum baseplate. They offer vibration damping as well as compensation for the thermal expansion (CTE) mismatch of the board and the baseplate, virtually absorbing all mechanical stress induced to the bench.

Since the payload is experiencing solar flux in between full exposure to the sun and full shadow by the ISS in each orbit, the spectroscopy board is surrounded by a thermal shield as shown in Fig. 6. Resistive heater foils guarantee a stable temperature environment (± 0.5 K), needed to ensure stable and reproducible locking to molecular iodine. The heat shield is connected to the baseplate with PEEK spacers for thermal decoupling. The components of the laser-optical system are mounted beneath the cover of the thermal shield. The laser-optical system is equipped with a number of fiber spools, allowing for stable fiber storage and proper fiber management. The housing can be fully closed with electrical and fiber feedthrough connector located on one of the sidewalls as the interface to other subsystems. The thermal shield and the housing have venting holes for use in vacuum and have threads for the mounting of the Iodine Control Electronics (ICE) on top. Captive screw mounting flanges are provided as the mechanical interface to the ArgUS multi-payload adapter platform. The ICE is designed as a self-standing physical box by SpaceTech GmbH. It has interfaces to the Iodine Spectroscopy Unit (ISU), the COMPASSO onboard computer (telemetry and telecommand), the ArgUS power supply and the OCXO 10 MHz reference signal.

Fig. 5 Spectroscopy board for Doppler-free MTS. Top: Schematic overview. The Zerodur bench hosts all optical components which are fixed to the board via adhesive bonding. The pump (dark green) and probe (light green) are coupled into the setup via fiber collimators, passing polarizers (POL) and half-wave plates (HWP) to clean the polarization and to adjust the power levels at certain locations via thin-film polarizers and beam-splitters. Mirrors guide the beams toward the iodine gas cell where two retroreflectors are used to allow for a four-pass configuration in a counter-propagating scheme. Bottom: Photograph of the integrated board without the mu-metal shield. The absorption of the laser in the iodine gas is clearly visible

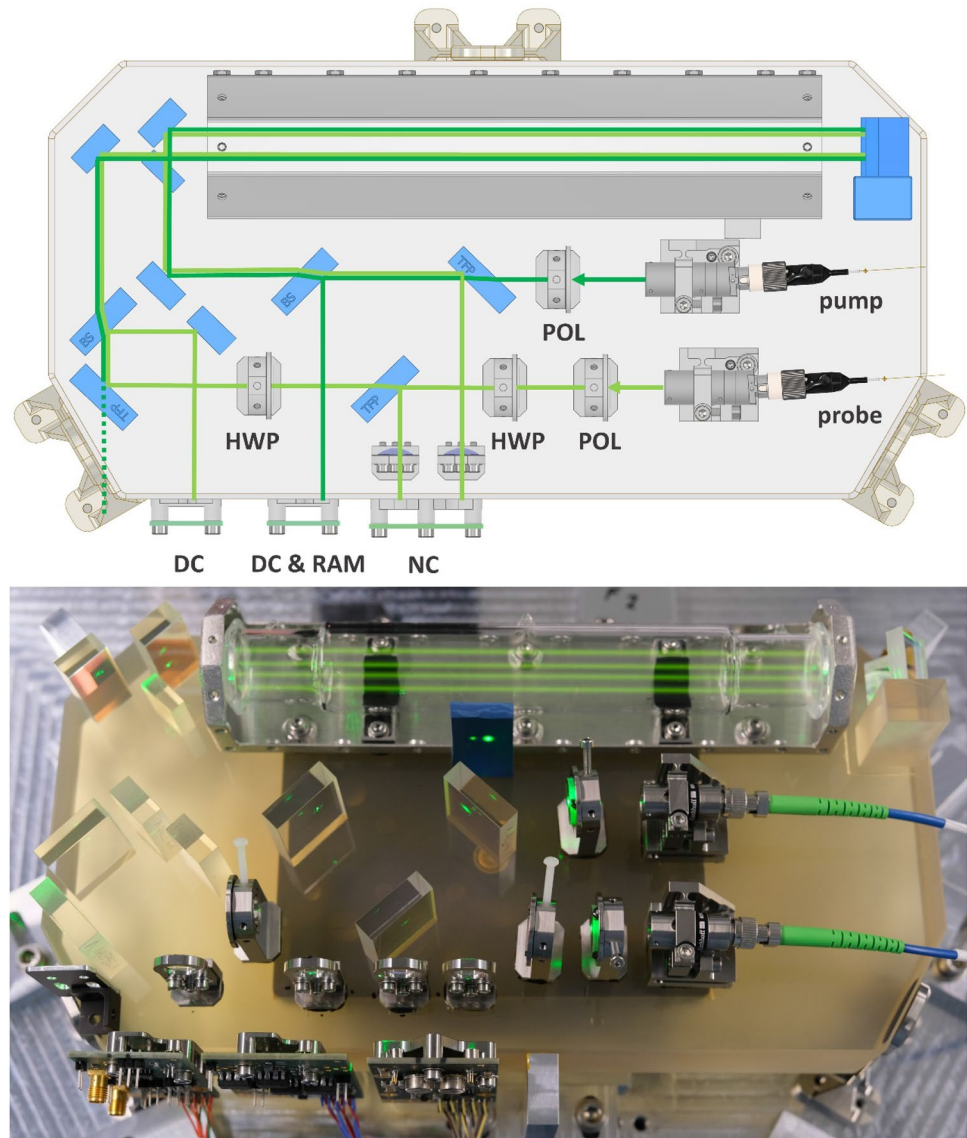

Breadboard model performance

For validation and testing purposes, two breadboard models of the iodine reference have been built using laboratory-grade components. Since every component of the iodine reference goes through a criticality assessment and is checked for flight heritage, uncritical components can be purchased in standard quality for the BBM. Critical parts are often identical to the planned flight components, such as the ECDL, the AOMs, the EOM and the vapor cell. Apart from the splitter unit, the fiber components were either connected with mating sleeves or via fiber-to-fiber free-beam coupling instead of splicing. This approach offers the possibility to quickly conduct diagnostics on the setup and exchange the (electro-)optical parts when the performance is below the desired values. The spectroscopy setup is built

on a $60\text{ cm} \times 45\text{ cm}$ breadboard and made of high-quality laboratory-grade optomechanics and has the same functionality as the integrated unit described in the previous section. A photograph of the setup is shown in Fig. 7. The light is coupled in via two single-mode polarization-maintaining fibers (blue tubing) and two fiber collimators. It is passing the beam manipulation optics and steering mirrors before entering the gas cell with an effective interaction length of 80 cm. The signals are detected by three photodiodes as described in the previous section. While short-term performance is not strongly reduced due to the adjustable optomechanics compared to a Zerodur-based spectroscopy board, the long-term performance is much more sensitive to thermal drifts and vibrations.

To verify the performance of the BBM and the fully fiber-based approach of the laser-optical system with an ECDL as

Fig. 6 CAD model of the iodine spectroscopy unit (ISU). The spectroscopy board is encapsulated by the heat shield indicated with red color (top left). The laser-optical system (bottom) is mounted beneath the cover plate of the ISU (orange). The electro-optical components are indicated by the dashed rectangle with the labeling from top left to bottom right. The closed harness is depicted on the top right side. The yellow side plate hosts all electrical connectors to power and control the ISU

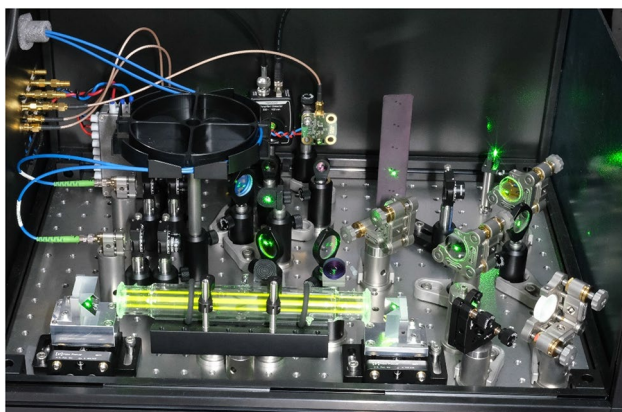
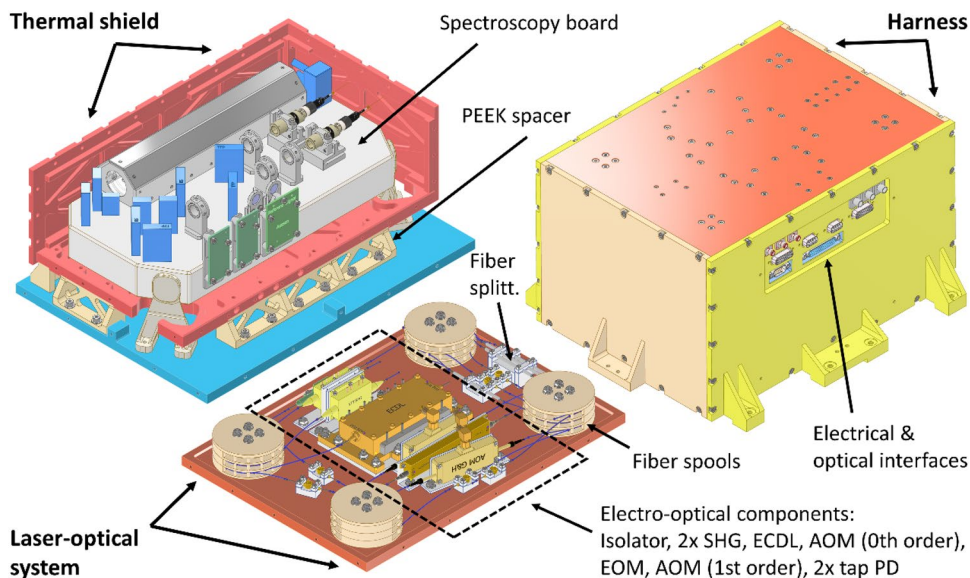

Fig. 7 Photograph of the iodine spectroscopy setup on breadboard level. The laser is locked to one line of the hyperfine structure of molecular iodine, clearly visible from the yellow to orange fluorescence light in the gas cell

the light source, the setup is locked to the iodine hyperfine transition (a_1 line of the $R(56)32-0$ transition, 532.245 nm) of molecular iodine and beat note signals in between the ECDL and an ultra-stable optical cavity and the ECDL and a frequency comb locked to a laboratory-grade maser are recorded with a sampling frequency of 10 Hz and 1 Hz, respectively. Here, the measurement was running for 27 h. The results are depicted in Fig. 8. The short-term performance is evaluated with the cavity, which has a very high performance at short timescales. The long-term performance is evaluated with the comb which has a very good performance at longer time since it is locked to a laboratory-grade maser. At the lowest times τ , the Allan deviation is in the 10^{-14} range and is almost two orders of magnitude better than the required stabilities for the COMPASSO mission.

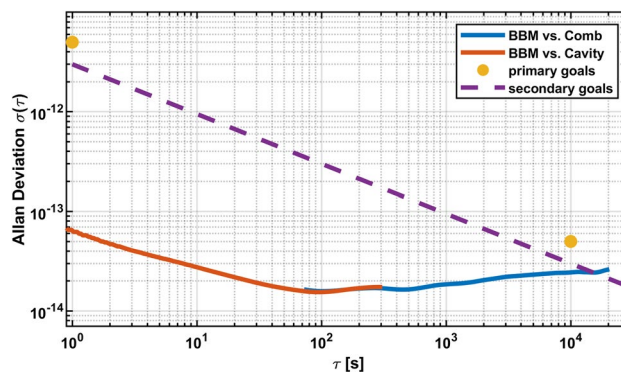

Fig. 8 Frequency instability of the BBM, given as Allan deviation for a given timespan τ . The measured short-term stability (red, measured against an ultra-stable cavity) is almost two orders of magnitude higher than the primary (yellow dots) and secondary (purple dashed line) goals of the COMPASSO mission for short times. The long-term performance (blue, measured against a comb locked to a maser) meets the requirements up to an integration times of around 10^4 s

The stability increases to a level of 1.5×10^{-14} for integration times of 100 s and slowly increases to 3×10^{-14} for integration times of 10^4 s staying within the requirements of COMPASSO up to this point. The long-term stability of a breadboard model is inherently limited by the application of adjustable optomechanics and additionally depends on the stability of the laboratory environment. Also, RAM and intensity control of the laser system were not applied yet. For a fully integrated, Zerodur-based spectroscopy board planned for the COMPASSO mission and additional laser power and RAM control, the performance is expected to be improved further into the 10^{-15} range at $\tau = 10^4$ s (Schuldt 2021). Overall, the measurement proves the fiber-based approach with ECDLs as the laser source to be an

appropriate choice for our application while keeping the SWaP consumption low.

Conclusion and outlook

With the COMPASSO mission, optical clock technologies will be demonstrated for first time as an in-orbit application. With two iodine frequency references, a frequency comb and a GNSS-disciplined OCXO, the system will be a fully functional clock with an aimed frequency stability down to the range of 10^{-15} . This quantum optical technology demonstrator will open the way for advanced scientific missions in the fields of geodesy, astronomy and the test of relativity theory. It will also allow for novel navigation satellite configurations and strongly improved navigation capabilities. The mission will prove the optical frequency and time transfer, opening the possibility to develop novel mission architectures, such as the KEPLER (Glaser 2020) mission proposal with a number of GNSS satellites in MEO and LEO orbits.

In this work, we presented how we successively improved absolute frequency references to achieve a space-compatible system, following the approach of using adhesive bonding of the optics and optomechanics on a Zerodur glass plate and the use of lightweight ruggedized and radiation hardened fiber-optical components. This approach offers the rigidity and durability needed for spaceflight. The COMPASSO mission design is displayed with the focus on the clock technology, and the performance of the system is demonstrated with a breadboard model. With imminent development and pre-flight models, the launch of the mission is foreseen for 2026. Given the success of the mission, this technology opens opportunities for future scientific missions such as Laser Interferometer Space Antenna (LISA, ESA 2022), Next Generation Gravity Missions (NGGM), improved Grace-like missions as well as commercial applications like Galileo Next Generation or the proposed KEPLER architecture (Glaser 2020) for improved navigation possibilities. For such missions, the demands on SWaP, lifetime and robustness are very strict. We address these demands within ongoing projects aiming at the development of miniaturized versions of optical frequency references based on molecular iodine and optical cavities, as well as frequency references utilizing other atomic transitions of iodine.

Acknowledgements We acknowledge the funding of the COMPASSO mission by the German Aerospace Center. We are thankful for the coordination of the project by the Galileo Competence Center and appreciate cooperation with industry partners within the project. We would like to express our gratitude toward every team member of the COMPASSO project and the excellent work which is put into the project.

Authors' contributions F.K. wrote the main manuscript text and prepared all figures. The measurement provided in Fig. 8 was performed by F.K., T.A., A.B. and M.G. All authors reviewed the manuscript.

Funding Open Access funding enabled and organized by Projekt DEAL. We appreciate the support by the Helmholtz-Gemeinschaft Deutscher Forschungszentren e.V. under grant number ZT-0007 (ADVANTAGE, Advanced Technologies for Navigation and Geodesy) and by the German Space Agency DLR with funds provided by the Federal Ministry of Economic Affairs and Climate Action (BMWK) under grant numbers 50001602 (BOOST), 50NA1905 (Optical Clocks for Galileo 2nd Generation, OG2G) and 50WM2260 (μ COMBINE). The iodine reference has been investigated within the "Iodine Optical Clock (IOC)" project funded by the EU Horizon 2020 program (prime SpaceTech GmbH, Immenstaad, Germany).

Data availability Data in this manuscript are available upon reasonable request.

Declarations

Competing interests The authors declare that they have no conflict of interest.

Ethics approval and consent to participate Not applicable.

Consent for publication The biographical information and photographs were provided by each author individually for publication.

Open Access This article is licensed under a Creative Commons Attribution 4.0 International License, which permits use, sharing, adaptation, distribution and reproduction in any medium or format, as long as you give appropriate credit to the original author(s) and the source, provide a link to the Creative Commons licence, and indicate if changes were made. The images or other third party material in this article are included in the article's Creative Commons licence, unless indicated otherwise in a credit line to the material. If material is not included in the article's Creative Commons licence and your intended use is not permitted by statutory regulation or exceeds the permitted use, you will need to obtain permission directly from the copyright holder. To view a copy of this licence, visit <http://creativecommons.org/licenses/by/4.0/>.

References

- Abich K et al (2019) In-orbit performance of the GRACE follow-on laser ranging interferometer. *Phys Rev Lett* 123:031101. <https://doi.org/10.1103/PhysRevLett.123.031101>
- Airbus (2022) <https://www.airbus.com/en/products-services/space-in-space-infrastructure/bartolomeo>
- Arie A, Byer RL (1994) Laser heterodyne spectroscopy of $^{127}\text{I}_2$ hyperfine structure near 532 nm. *J Opt Soc Am B* 11:866–866. <https://doi.org/10.1364/JOSAB.10.001990>
- Braxmaier C, Müller H, Pradl O, Mlynek J, Peters A, Schiller S (2001) Tests of relativity using a cryogenic optical resonator. *Phys Rev Lett* 88:010401. <https://doi.org/10.1103/PhysRevLett.88.010401>
- Braxmaier C et al (2010) The Space-time asymmetry research (STAR) program. In: EFTF-2010 24th European frequency and time forum, pp 1–8. <https://doi.org/10.1109/EFTF.2010.6533664>
- Burt EA, Prestage JD, Tjoelker RL, Enzer DG, Kuang D, Murphy DW, Robison DE, Seibert JM, Wang RT, Elay TA (2021) Demonstration of a trapped-ion atomic clock in space. *Nature* 595:43–47. <https://doi.org/10.1038/s41586-021-03571-7>
- Cacciapuoti L, Dimarcq N, Salomon C (2017) The ACES mission: scientific objectives and present status. In: Proceedings of SPIE 10567, international conference on space optics—ICSO 2006, p 105673Y. <https://doi.org/10.1117/12.2308164>

- Cheng F, Jin N, Zhang F, Li H, Du Y, Zhang J, Deng K, Lu Z (2021) A 532 nm molecular iodine optical frequency standard based on modulation transfer spectroscopy. *Chin Phys B* 30:050603. <https://doi.org/10.1088/1674-1056/abd754>
- Dahl K et al (2019) A new laser technology for LISA. In: Proceedings, international conference on space optics—ICSO 2018, vol 11180, p 111800C. <https://doi.org/10.1117/12.2535931>
- Delva P et al (2019) Gravitational redshift test using eccentric Galileo Satellites. *Phys Rev Lett* 121:231101. <https://doi.org/10.1103/PhysRevLett.121.231101>
- Döringshoff K, Schuldt T, Kovalchuk EV, Stühler J, Braxmaier C, Peters A (2017) A flight-like absolute optical frequency reference based on iodine for laser systems at 1064 nm. *Appl Phys B* 123:183. <https://doi.org/10.1007/s00340-017-6756-1>
- Döringshoff K et al (2019) Iodine frequency reference on a sounding rocket. *Phys Rev Appl* 11:054068. <https://doi.org/10.1103/PhysRevApplied.11.054068>
- Drever RWP, Hall JL, Kowalski FV, Hough J, Ford GM, Munley AJ, Ward H (1983) Laser phase and frequency stabilization using an optical resonator. *Appl Phys B* 31:97–105
- Droz F, Mosset P, Barmaverain G, Rochat P, Wang Q (2006) The on-board galileo clocks: rubidium standard and passive hydrogen maser—current status and performance. In: Proceedings of the 20th EFTF, pp 420–426
- Droz F et al (2008) Galileo rubidium standard and passive hydrogen maser current status and new development. In: Del Re E, Ruggieri M (eds) Satellite communications and navigation systems signals and communication technology. Springer, Boston. https://doi.org/10.1007/978-0-387-47524-0_10
- Eisele C, Nevesky AY, Schiller S (2009) Laboratory test of the isotropy of light propagation at the 10^{-17} level. *Phys Rev Lett* 103:090401. <https://doi.org/10.1103/PhysRevLett.103.090401>
- European Space Agency (2019) H2020-ESA-038, GNSS evolutions experimental payloads and science activities—call for ideas
- European Space Agency (2022) The laser interferometer space antenna—observing gravitational waves from space <https://sci.esa.int/s/w5qyMBw>. Accessed 22 Dec 2022
- Glaser S, Michalak G, Männel B, König R, Neumayer KH, Schuh H (2020) Reference system origin and scale realization within the future GNSS constellation “Kepler.” *J Geod* 94:117. <https://doi.org/10.1007/s00190-020-01441-0>
- Gohlke M, Schuldt T, Döringshoff K, Peters A, Ulrich J, Weise D, Braxmaier C (2015) Adhesive bonding for optical metrology systems in space applications. *J Phys Conf Ser* 610:012039. <https://doi.org/10.1088/1742-6596/610/1/012039>
- Gürlebeck N et al (2018) BOOST: a satellite mission to test Lorentz invariance using high-performance optical frequency references. *Phys Rev D* 97:124051. <https://doi.org/10.1103/PhysRevD.97.124051>
- Haagmans R, Siemes C, Massotti L, Carraz O, Silvestrin P (2020) ESA’s next-generation gravity mission concepts. *Rendiconti Lincei Scienze Fisiche e Naturali* 31:15–25. <https://doi.org/10.1007/s12210-020-00875-0>
- Herrmann S, Senger A, Möhle K, Nagel M, Kovalchuk EV, Peters A (2009) Rotating optical cavity experiment testing Lorentz invariance at the 10^{-17} level. *Phys Rev D* 80:105011. <https://doi.org/10.1103/PhysRevD.80.105011>
- Herrmann S et al (2018) Test of the gravitational redshift with galileo satellites in an eccentric orbit. *Phys Rev Lett* 121:231102. <https://doi.org/10.1103/PhysRevLett.121.231102>
- Hoang TM, Chung SK, Le T, Prestage JD, Yi L, Tjoelker RI, Yu N (2019) Performance of micro mercury trapped ion clock. <https://trs.jpl.nasa.gov/bitstream/handle/2014/5/1039/CL%2019-2037.pdf?sequence=1>. Accessed 22 Dec 2022
- Hobbs PCD (1997) Ultrasensitive laser measurements without tears. *Appl Opt* 36:903–920. <https://doi.org/10.1364/AO.36.000903>
- Hong FL, Ishokawa J, Zhang Y, Guo R, Onae MH (2004) Frequency reproducibility of an iodine-stabilized Nd:YAG laser at 532 nm. *Opt Comm* 235:377–385. <https://doi.org/10.1016/j.optcom.2004.02.044>
- Ito N (2000) Doppler-free modulation transfer spectroscopy of rubidium $5^2S_{1/2}$ – $6^2P_{1/2}$ transitions using a frequency-doubled diode laser blue-light source. *Rev Sci Instrum* 71:2655. <https://doi.org/10.1063/1.1150672>
- Jaatinen E, Chartier JM (1998) Possible influence of residual amplitude modulation when using modulation transfer with iodine transitions at 543 nm. *Metrologia* 35:75. <https://doi.org/10.1088/0026-1394/35/2/2>
- Jaatinen E, Hopper DJ, Back J (2008) Residual amplitude modulation mechanisms in modulation transfer spectroscopy that use electro-optic modulators. *Meas Sci Technol* 20:025302. <https://doi.org/10.1088/0957-0233/20/2/025302>
- Kürbis C, Bawamia A, Krüger M, Smol R, Peters A, Wicht A, Tränkle G (2020) Extended cavity diode laser master-oscillator-power-amplifier for operation of an iodine frequency reference on a sounding rocket. *Appl Opt* 59:253–262. <https://doi.org/10.1364/AO.379955>
- Laurent P, Massonnet D, Cacciapuoti L (2015) The ACES/PHARAO space mission. *C R Phys* 16:540–552. <https://doi.org/10.1016/j.crhy.2015.05.002>
- Li L, Liu F, Wang C, Chen L (2012) Measurement and control of residual amplitude modulation in optical phase modulation. *Rev Sci Instrum* 83:043111. <https://doi.org/10.1063/1.4704084>
- Mankins JC (2004) Technology readiness level. http://www.artemisinnovation.com/images/TRL_White_Paper_2004-Edited.pdf. Accessed 22 Dec 2022
- Martin KW et al (2018) Compact optical atomic clock based on a two-photon transition in rubidium. *Phys Rev Appl* 9:014019. <https://doi.org/10.1103/PhysRevApplied.9.014019>
- McGrew WF et al (2018) Atomic clock performance enabling geodesy below the centimetre level. *Nature* 564:87–90. <https://doi.org/10.1038/s41586-018-0738-2>
- Micalizio S, Levi F, Calosso CE, Gozzelino M, Godone A (2021) A pulsed-laser Rb atomic frequency standard for GNSS applications. *GPS Solut* 25:94. <https://doi.org/10.1007/s10291-021-01136-9>
- Müller H, Herrmann S, Braxmaier C, Schiller S, Peters A (2003a) Modern Michelson–Morley experiment using cryogenic optical resonators. *Phys Rev Lett* 91:020401. <https://doi.org/10.1103/PhysRevLett.91.020401>
- Müller H, Herrmann S, Braxmaier C, Schiller S, Peters A (2003b) Precision test of the isotropy of light propagation. *Appl Phys B* 77:719–731. <https://doi.org/10.1007/s00340-003-1318-0>
- Nevsky AY et al (2002) Frequency comparison and absolute frequency measurement of I_2 -stabilized lasers at 532 nm. *Opt Commun* 192:263–272. [https://doi.org/10.1016/S0030-4018\(01\)01190-7](https://doi.org/10.1016/S0030-4018(01)01190-7)
- Origlia S et al (2018) Towards an optical clock for space: compact, high-performance optical lattice clock based on bosonic atoms. *Phys Rev A* 98:053443. <https://doi.org/10.1103/PhysRevA.98.053443>
- Prübster BJ, Lezius M, Mandel O, Braxmaier C, Holzwarth C (2021) FOKUS II—space flight of a compact and vacuum compatible dual frequency comb system. *JOSA B* 38:932–939. <https://doi.org/10.1364/JOSAB.413929>
- Ressel S et al (2010) Ultrastable assembly and integration technology for ground- and space-based optical systems. *Appl Opt* 49:4296–4303

- Sanjuan J, Abich K, Blümel L, Gohlke M, Gualani V, Oswald M, Wegehaupt T, Schuldt T, Braxmaier C (2021) Simultaneous laser frequency stabilization to an optical cavity and an iodine frequency reference. *Opt Lett* 46:360–363. <https://doi.org/10.1364/OL.413419>
- Schkolnik V et al (2017) JOKARUS—design of a compact optical iodine frequency reference for a sounding rocket mission. *EPJ Quantum Technol* 4:9. <https://doi.org/10.1140/epjqt/s40507-017-0063-y>
- Schmidt TD et al (2023) Optical technologies for future global navigation satellite systems. In: Proceedings of the IEEE symposium on position location and navigation (PLANS), pp 311–317. <https://doi.org/10.1109/PLANS53410.2023.10140082>
- Schmidt TD et al (2022) COMPASSO: In-orbit verification of optical key technologies for future GNSS, In: Proceedings of the 53rd annual precise time and time interval systems and applications meeting, pp 158–182. <https://doi.org/10.33012/2022.18286>
- Schuldt T, Döringshoff K, Kovalchuk EV, Keetman A, Pahl J, Peters A, Braxmaier C (2017) Development of a compact optical absolute frequency reference for space with 10^{-15} instability. *Appl Opt* 56:1101–1106. <https://doi.org/10.1364/AO.56.001101>
- Schuldt T et al (2021) Optical clock technologies for global navigation satellite systems. *GPS Solut* 25:83. <https://doi.org/10.1007/s10291-021-01113-2>
- Schuldt T et al (2015) mSTAR: testing special relativity in space using high performance optical frequency references. In: 2015 Joint conference of the IEEE international frequency control symposium & the European frequency and time forum, 2015, pp 47–50. <https://doi.org/10.1109/FCS.2015.7138789>
- Schuldt T, Wörner L, Braxmaier C and the COFROS team (2019) In-orbit-verification of optical clock technologies. In: 70th International astronomical congress (IAC), IAC-19-A2.1.2
- Shang H, Zhang X, Zhang S, Pan D, Chen H, Chen J (2017) Miniaturized calcium beam optical frequency standard using fully-sealed vacuum tube with 10^{-15} instability. *Opt Express* 25:30459–30467. <https://doi.org/10.1364/OE.25.030459>
- Takamoto M, Ushijima I, Ohmae N, Yahagi T, Kokado K, Shinkai H, Katori H (2020) Test of general relativity by a pair of transportable optical lattice clocks. *Nat Photon* 14:411–415. <https://doi.org/10.1038/s41566-020-0619-8>
- Ushijima I, Takamoto M, Das M, Ohkubo T, Katori H (2015) Cryogenic optical lattice clocks. *Nat Photon* 9:185–189. <https://doi.org/10.1038/nphoton.2015.5>
- Whittaker EA, Gehrtz M, Bjorklund GC (1985) Residual amplitude modulation in laser electro-optic phase modulation. *J Opt Soc Am B* 2:1320–1326. <https://doi.org/10.1364/JOSAB.2.001320>
- Wolf P, Bize S, Clairon A, Luiten AN, Sanarelli G, Tobar ME (2003) Tests of Lorentz invariance using a microwave resonator. *Phys Rev Lett* 90:060402. <https://doi.org/10.1103/PhysRevLett.90.060402>
- Zang EJ, Cao JP, Li Y, Li CY, Deng YK, Gao CQ (2007) Realization of four-pass I_2 absorption cell in 532-nm optical frequency standard. *IEEE Trans Instrum Meas* 56:673–676. <https://doi.org/10.1109/TIM.2007.890816>
- Zhang S et al (2017) Compact Rb optical frequency standard with 10^{-15} stability. *Rev Sci Instrum* 88:103106. <https://doi.org/10.1063/1.5006962>

Publisher's Note Springer Nature remains neutral with regard to jurisdictional claims in published maps and institutional affiliations.



Frederik Kuschewski is a research scientist in the DLR department for quantum metrology with the focus on optical clock technology. In the COMPASSO project, he is responsible for the performance verification of the iodine reference and scientific aspects of the mission. He worked in the field of applied optics since his diploma thesis and received his PhD from University of Technology Dresden in 2019.



Jan Wüst joined the German Aerospace Center (DLR) after his master's degree from the HTWG Konstanz – University of Applied Sciences in 2019 and worked for the Institute of Quantum Technologies (Ulm) till 2022. Within the COMPASSO project, he was responsible for the mechanical and thermal design of the Iodine Reference subsystem. Since 2022 he is working on his PhD on iodine frequency references at the university of Ulm in cooperation with DLR, STI and ADS.



Markus Oswald is doing his PhD on iodine frequency references for space at the University of Bremen. After his master's degree at the HTWG Konstanz – University of Applied Sciences in 2014, he has contributed to the development and realization of various iodine frequency reference setups for DLR and ZARM.



Tim Blomberg joined the German Aerospace Center (DLR), Institute of Quantum Technologies, in 2021. After his master's degree from the RWTH Aachen, in 2019, he worked on developing mounting concepts based on adhesive bonding technologies for iodine-based optical frequency references. His responsibilities now include system and AIT engineering for the iodine reference in the COMPASSO project.



Martin Gohlke joined the German Aerospace Center (DLR), Institute of Space Systems (Bremen), in 2012. He worked on the optical ground support equipment for the GRACE follow-on mission in cooperation with DLR institutes and space companies (Airbus, STI and JPL). LISA-related topics such as laser interferometry, optical frequency references and temperature sensors are part of his current activities.



André Bußmeier joined the German Aerospace Center (DLR), Institute of Quantum Technologies (Bremen), in 2021. He received his master's degree in photonics from FH-Münster – University of Applied Sciences. His thesis dealt with the Pound–Drever–Hall stabilization of a continuous Ti:Sa ring laser. In the COMPASSO project, he is responsible for the integration and testing of the spectroscopy unit and the laser board.



Jonas Bischof joined the German Aerospace Center (DLR), Institute of Quantum Technologies (Ulm), in 2021. He received his master's degree from the University of Applied Science Bremen for the detailed design study of an Electric Liquid Oxygen Pump. Produce assurance and requirements engineering within COMPASSO are part of his current responsibilities.



Klaus Abich joined the German Aerospace Center (DLR), Institute of Space Systems (Bremen), in 2013. He worked on the optical ground support equipment for the GRACE follow-on mission in cooperation with DLR institutes and space companies (Airbus, STI and JPL). Assembly, integration and test activities within the GRACE-FO were part of his responsibilities.



Alex Boac graduated as a physics and aerospace engineer, in Toulouse, France. He worked in the COMPASSO project between October 2021 and June 2023 in Bremen, Germany, as a space and requirements engineer, additionally supporting system engineering, procurement activities and performed laser-based optical measurements. He recently joined OHB SE AG, in Bremen, and now works as a satellite systems engineer for ESA's space exploration mission PLATO.



Niklas Röder joined the German Aerospace Center (DLR), Institute of Quantum Technologies, in 2022. He received his bachelor's degree in physics and is working on his master thesis in Space Engineering at the University of Bremen. His current responsibilities are the mechanical and thermal design of the COMPASSO Iodine Frequency Reference.



Tasmim Alam joined the Institute of Quantum Technology (Bremen) at the German Aerospace Center (DLR) in 2022, where he works on the development of optical frequency references based on molecular iodine for the COMPASSO project. He received his PhD in 2020 from the Technical University of Berlin for his work on the spectroscopic applications of terahertz quantum-cascade lasers (QCLs).



Klaus Döringshoff joined the Ferdinand-Braun-Institut, Leibniz-Institut für Höchstfrequenztechnik (Berlin) in 2020, and works on the development of optical frequency references based on high resolution laser spectroscopy. He received his PhD from the Humboldt-Universität zu Berlin in 2018 for his work on the optical frequency references based on rovibronic transitions in molecular iodine.



Jan Hrabina is a research scientist at the Institute of Scientific Instruments, Czech Academy of Sciences. His research is oriented toward time and frequency metrology, ultra-stable laser standards, references of optical frequencies and precise time and frequency dissemination. He is responsible for a research team developing optical references based on spectroscopic absorption cells.



Thilo Schuldt joined the German Aerospace Center (DLR) in 2013 and is leading the development of the COMPASSO iodine reference. He received his PhD from the Humboldt-Universität zu Berlin for his work on the space-based gravitational wave detector LISA. Thilo Schuldt has been working on many ESA- and DLR-funded projects in optical metrology, focusing on optical frequency references and high sensitivity laser interferometry.



Miroslava Holá is a research assistant at the Institute of Scientific Instruments, Czech Academy of Sciences. She received her PhD from the Brno University of Technology for her work on advanced interferometric methods for coordinate measurements. Her work is focused on metrology of length, laser interferometry and optical assembly design.



Claus Braxmaier is chair of Quantum Metrology, Ulm University, in cooperation with DLR. Braxmaier is head of the DLR department “Quantum Metrology” in Ulm at the DLR institute of quantum technologies. He received a PhD from the University of Konstanz and has been working on many ESA- and DLR-funded projects in space sciences, gravity missions, cold atom optics, quantum metrology, frequency references and laser interferometry.



Jindřich Oulehla joined the Institute of Scientific Instruments, Czech Academy of Sciences (ISI), in 2009 following his master's degree in solid state physics from the Masaryk University in Brno. His main area of interest lies in optical thin-film technology. He received his PhD from the Brno University of Technology for his work in designing and developing thin-film optical coatings.