



# A new automatic method for demoulding plastic parts using an intelligent robotic system

Daniel Sánchez-Martínez<sup>1</sup> · Carlos A. Jara<sup>1</sup> · Francisco Gomez-Donoso<sup>2</sup>

Received: 6 June 2023 / Accepted: 2 October 2023 / Published online: 21 October 2023  
© The Author(s) 2023

## Abstract

Nowadays, there are many different industrial processes in which people spend several hours performing tedious and repetitive tasks. Furthermore, most of these processes involve the manipulation of dangerous materials or machinery, such as the toy manufacturing, where people handle ovens with high temperatures and make weary physical effort for a long period of time during the process. In this work, it is presented an automatic and innovative collaborative robotic system that is able to deal with the demoulding task during the manufacturing process of toy dolls. The intelligent robotic system is composed by an UR10e robot with a RealSense RGB-D camera integrated which detects the pieces in the mould using a developed vision-based algorithm and extracts them by means of a custom gripper located at the end of the robot. We introduce a pipeline to perform the demoulding task of different plastic pieces relying in the use of this intelligent robotic system. Finally, to validate this approach, the automatic method has been successfully implemented in a real toy factory providing a novel approach in this traditional manufacturing process. The paper describes the robotic system performance using different forces and velocities, obtaining a success rate of more than 90% in the experimental results.

**Keywords** Robotics · Toy industry · Automation · Soft · Flexible · Manipulation

## 1 Introduction

Industrial environments are usually surrounded by hazardous situations. One of them is the dangerous machinery, that can cause severe damage to human workers. For instance, in the toy industry, there are production ovens which are at high temperatures. The features of the handled material should be also considered as they can be composed of toxic substances that could harm humans likewise.

Although factories invest large amounts of resources in safety systems to prevent accidents through the integration of laser barriers and other measures and equipment, the traditional manufacturing processes have really high production targets with short cycle times which rise the stress of the operators. Human operators work for several hours on the same task; thus, they are more prone to get distracted and to make mistakes resulting in dangerous situations.

As mentioned, manual industrial processes are often repetitive and composed of tedious tasks and movements, especially in the toy manufacturing industry, which is the focus of this work. This process to create a plastic toy is based on the following tasks: first, operators fill the moulds with the plastic material, then they introduce the mould into a rotomoulding oven; they put the mould into an air cooler after that; finally, the operators place the mould (which is still at high temperatures) in the demoulding zone to gently extract the hot pieces that are inside the moulds. Operators repeat this process for several hours manually managing several moulds at the same time which increases their stress level.

This paper presents a new intelligent robotic system capable of performing the demoulding task of the entire toy manufacturing process by carrying out the most labour-intensive

---

Carlos A. Jara and Francisco Gomez-Donoso contributed equally to this work.

---

✉ Daniel Sánchez-Martínez  
d.sanchez@ua.es

Carlos A. Jara  
carlos.jara@ua.es

Francisco Gomez-Donoso  
fgomez@ua.es

<sup>1</sup> Human Robotics, University of Alicante, Ctra. San Vicente del Raspeig SN, 03690 Alicante, Alicante, Spain

<sup>2</sup> University Institute for Computer Research, Ctra. San Vicente del Raspeig SN, 03690 Alicante, Alicante, Spain

part of the process. Therefore, this approach directly reduces the stress and potential injuries to operators who can perform other dexterous and human-based tasks. This system is composed by the usual machinery of the toy manufacturing process (rotomoulding oven, air cooler, moulds, etc.), external devices such as RGB-D cameras, pneumatic actuators, emergency buttons, and safety laser scanners, and a UR10e collaborative robot arm. All mentioned devices and machinery have been integrated at INDUSTRIA AUXILIAR JUEMA S.L., an actual doll manufacturing company.

The main contribution of this work is the development of a new collaborative robotic system capable of performing a traditional manufacturing task such as the demoulding of soft plastic pieces autonomously, contributing to the creation of new future smart factories such as in [3]. As mentioned previously, during the extraction of the pieces, the mould is still at high temperatures, which means that the plastic pieces inside are deformable and flexible. Therefore, it completely changes the usual paradigm of rigid handling due to the possible deformations that pieces may suffer, so higher forces must be applied to accurately remove them from the mould in order to not damage or break them. Finally, with this approach, a reduction of the operator's stress has been achieved, thus allowing them to perform other tasks with higher dexterity requirements or relocating them to the other sub-tasks of the process where the physical effort is less intensive.

The rest of the paper is structured as follows. In Sect. 2, different works with related objectives or developments are commented. In Sect. 3, it explains the steps of the process in the developed pipeline. Then, in Sect. 4, the experiments and results of the approach are shown to ensure the efficiency and accuracy of the system. Finally, in Sect. 5, some conclusions are described.

## 2 Related works

The state of the art related to the innovation and automation of industrial processes is really extended. The rise of the competitiveness between manufacturing factories has forced the integration of new technologies, especially in the robotic manipulation of soft and deformable materials. In the manufacturing processes, human operators manipulate different kinds of objects composed by soft material, such as plastic pieces, tyres, soles, and even food. One example of the automation of an industrial process handling deformable objects is [1], where authors present an innovative robotic system to manipulate clothes and automate the stitching process of cloth and a foam pad. However, they manipulate planar objects, which reduces the number of unknowns and uncertainty in comparison with 3D objects as proposed in this paper. In [10], the authors work with linear objects to perform the shape control without running real-time simulations

or solving optimization problems, and they base their work on a partition of the nodal coordinates that allows deriving a control law directly from tangent stiffness matrices. Another approach about intelligent manipulation is proposed in [6], where authors present a new control framework for manipulating soft objects applying deep reinforcement learning to deform them and achieve a desired shape. Although the linear objects are more similar to this case, they are still simpler, and one of the main contributions of these works is based on simulation. Other kinds of learning examples are explained in [5], specifically learning from demonstration, a technique that creates policies from example state to action mappings. That approach defines a teacher, which provides the examples or demonstrations to the learner, according to the two different phases that the authors define to organize these techniques: the first one, the acquisition of the data, and the second one, the deriving of a policy from that information. These novel techniques could be useful for the demoulding task due to the complexity for the robot and the possibility of recording data from the expert operators. However, the gathering of information in our use case is really complex; operators use both hands applying several forces and carrying out determined trajectories to demould the pieces. In [4], the authors have implemented a novel approach called Advice-Operator Policy Improvement (A-OPI). Demonstration learning improves policies when the number of samples is larger; however, A-OPI synthesizes new data from a student execution and a teacher advice. Results show great potential as they surpass the performance of teleoperation. However, the system works for low-level motion control, which makes it impossible to integrate into our system due to the complexity of the task execution.

The approach presented in this paper is based on a high-effort required task, such as in [13], where it explains a strategy to improve the performance of current commercial industrial robots using a force-impedance controller. Nevertheless, our proposal's aim is to create a system where operators and robots can work together, so these kinds of industrial robots are not allowed in a collaborative task. In [16], the authors present a force control loop used in a collaborative robot for sanding materials and state that collaborative robots can perform the same sanding task with similar results to industrial robots. The main difference with the work presented in this paper is the great dexterity of the robot movements needed when demoulding pieces instead of planar trajectories of that paper. In [18], it explains the current situation of robot applications in the food industry, which has high-quality requirements, and concludes with the enormous number of possible tasks that robots can carry out in this sector. Although the food sector is a more common research field than the toy one, similarities can be found with this industry, which has very strict quality requirements in the final product. Contrary to the other manufacturing fields, chil-

dren's doll production industry has not been much explored, and there are no robotic solutions integrated in real industrial environments, a fact that this work aims to change. In [17], it proposes a system that allows a safe cooperation between humans and high-payload robots during industrial tasks performance thanks to a tactile floor with spacial resolution able to define static safety zones or dynamic ones considering the current position of the joints and velocities. To integrate this system, companies need to implement major infrastructural changes in their factories. The solution presented in this paper aims to integrate two safety laser scanning devices to cover the entire working space and the areas shared between the operator and the robot in order to ensure human safety.

Plastic sector is really extensive and is composed by different kinds of tasks, such as in [14], where the authors developed a new approach which used the discrete properties of the moulds to create the configuration of the plastic injection moulds. The common features between this plastic material and the children's dolls highlight the challenges associated with handling soft materials, and how their physical behaviour varies based on temperature. The study of these properties is tedious and complicated as shown in [11], where the authors present an automatic shape control of deformable wires based on the unknown deformation model or the mechanical properties of the object. They just use some visual features to calculate the deformation and improve the manipulation. A related work is described in [8], where the authors report the first autonomous robotic solution for the USB wires soldering task. The similarities with the approach presented in this paper arise due to the repetitive and closed-cycle nature of the demoulding process.

As mentioned previously, toy industry is a manufacturer and traditional sector which is composed mainly by small-and-medium enterprises (SMEs), which are not usually able to develop or integrate new technologies into their production processes. In [19], it explains the possibility of automation in SMEs with a collaborative robot and learning-based vision systems. They propose an automatic system for object detection and quality control of products, together with a multi-functional gripper capable of performing different operations without tool changing. In [7], the authors present a study about the reinforcement learning in contact manipulation robotic tasks which explains the increase of the research in this field. In addition, they explain different kinds of contact manipulation tasks depending on the dynamic interaction of the objects. Our use case could be classified in the 'pushing tasks' group, where authors expose the difficulty from the unknown and nonlinear dynamics when the robot must perform gentle manipulation on objects of different sizes, shapes, and textures. In [12], the authors present a review about the smart robotic manufacturing representing the new epoch of a higher degree of intelligence in industrial tasks carried out by the robots. In [15], the authors present

a user-friendly model of robot skills, tested in real industrial scenarios, specifically designed for operators with no prior knowledge of robotics. This aspect holds significant value for this work because one of the goals of this approach is to prevent operator replacement and, instead, to involve them in the operational process by making it more accessible and manageable. In addition to the task automation, the approach supports and trains the operators to make the transition to the robotizing of the demoulding task easier. This fact could be supported with the proposal explained in [2], where the authors present a demonstration learning framework for robots wherein they developed a force-based acquisition system to capture the task essence in two distinct scenarios: human-human and human-robot collaboration. The purpose is to extract task-specific features and transfer these skills to the robot for the purpose of extracting task-specific features and transfer these skills to the robot. In this context, the involvement of the human factor becomes crucial as it plays a vital role in extracting task-related features, facilitating the robot's learning process, and fostering collaboration between the human and the robot during task execution. They tested the system in the co-manipulation of objects and assembly of simple interlocking parts. In contrast to deformable objects, rigid manipulation makes the collaboration and the acquisition of task parameters easier. Nevertheless, due to the complexity of the soft object parameters and models, in this work, the authors are able to extract the knowledge of the operators to programme the robot trajectories for the demoulding task. To improve the manipulation of flexible objects, in [9], it presents a survey of model-based off-line manipulation planning systems. An initial object classification is stated, dividing into volumetric, planar, and linear, then they categorize the planning strategies according to the type of goal: path planning, folding/unfolding, topology modifications, and assembly. Although model-based strategies are really useful to manipulate deformable objects, in the focused scenario of this paper, the deformation parameters may change during the task performance due to the temperature variation.

As stated in this section, currently, there is no approach as presented in this paper: a new intelligent robotic system capable to perform the demoulding of soft plastic pieces in an autonomous way. In addition, this innovative system can collaborate with the human operator in order to finish the entire toy manufacturing process.

### 3 Demoulding pipeline

The demoulding task of the toy manufacturing industry is one of the several steps of the production process. The company has divided into different groups the operators in order to cover all steps; one group produces the liquid plastic material

from raw powder and some additives, and another group uses this liquid material to manufacture the solid pieces relying in the rotomoulding manufacturing process. Then, while one group paints, sews the hair, and puts the eyes on the head, the other group assembles the pieces. Finally, the assembled doll is packaged and distributed to retailers.

### 3.1 Manual task

As explained before, this industrial process involves different tasks. However, this work is focused in the most physically demanding task for the operators, namely the rotomoulding manufacturing process, which is really common in plastic industries. Figure 1 explains the different steps of this technique.

As shown in Fig. 1, in the first action, the operator fills the mould with the liquid plastic material (Fig. 2a) and closes it. Then, the mould is then placed in the rotomoulding oven and starts heating while rotating on two axes to distribute the material over the entire inner surface of the mould. After the heating step, the mould is introduced in a cooling zone to complete the creation of the piece. Finally, the operator places the mould in the demoulding zone, and they extract the pieces as shown in Fig. 2b.

As seen in Fig. 2, operators work directly with the moulds and must utilize both hands to extract the pieces, as the task demands significant force. Moreover, they must have exceptional dexterity in order to successfully demould certain pieces, which can be quite challenging due to their intricate shapes. In addition, they have to do it while the mould is still at high temperatures; otherwise, the piece will cool down and get stuck inside. Thus, the workers are in contact with a harmful element, as stated above. The temperature of the moulds during the task is set by the operators specifying the time and temperature of the rotomoulding process in the oven.

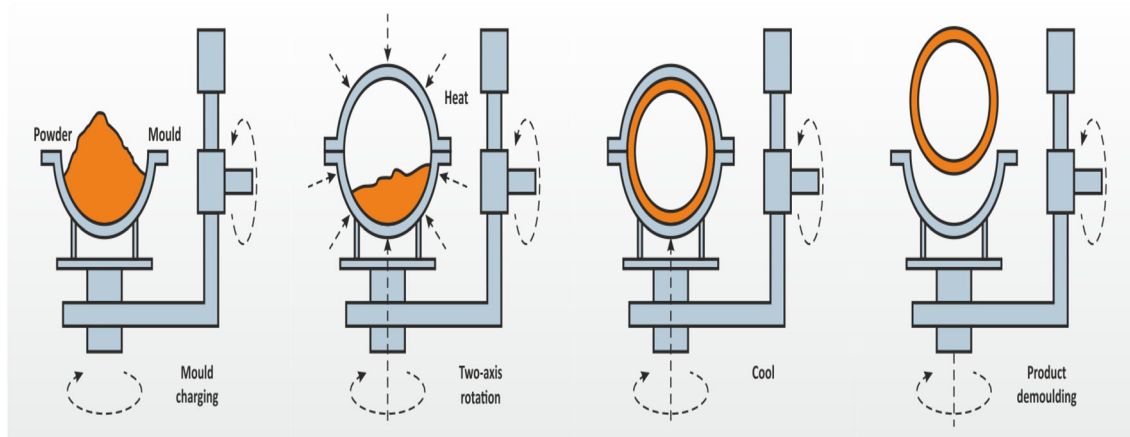
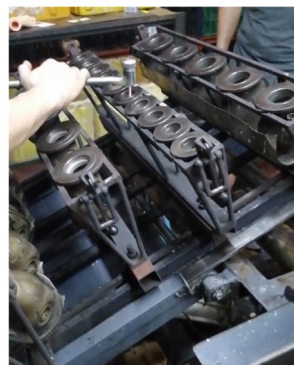

Fig. 1 Rotomoulding manufacturing process



(a) Moulds filling.



(b) Pieces extraction.

Fig. 2 Moulds used for the traditional manual task

### 3.2 Automatic task

Figure 3 shows the proposed workflow for the robotic system, where it is divided into operator and robot tasks.

The main challenge of this process is to manipulate this material under the constraint of its flexibility and the short cycle time in which the object should be managed. If the piece spends too much time in the mould and is not extracted, it

**Fig. 3** Workflow of the automatic demoulding process

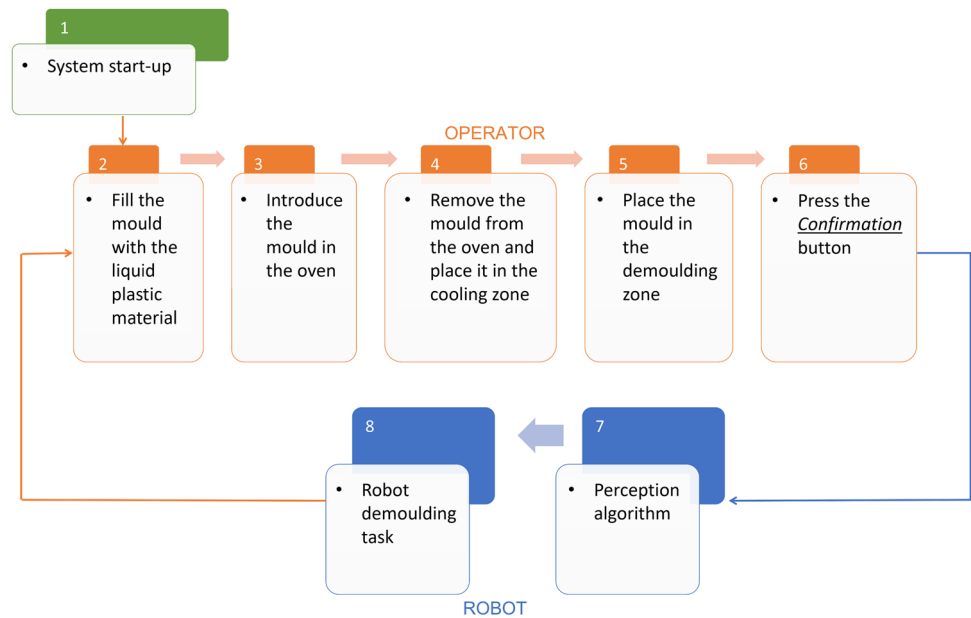

cools down and it is more difficult to demould and eventually would break during the process.

In order to develop the automatic system, a robotic cell mock-up has been designed and developed (Fig. 4). This mock-up allows us to execute first tests and develop the different algorithms before the integration in the real industrial environment.

The red area in Fig. 4 a and c marks the air cooler, the yellow area marks the rotomoulding oven, and the blue area marks the demoulding zone.

This setup allows the robot to perform the demoulding task, but the operator is still required for the rest of the steps

regardless. However, the most labour-intensive task has been removed for the operators and devolved to the robot. In order to perform this task and check the viability, Fig. 5 shows the 4 different moulds that will be used according to the 4 parts of the children’s doll: head, arms, legs, and body.

The automatic extraction pipeline, which is explained in depth in Sect. 3.3, is described next. The steps are intended to mimic the manual process. Hence, once the mould is placed in the demoulding zone by the operator, the robot uses a RGB-D camera to get 3D information of the environment. Then, the top of the mould is detected using computer vision algorithms, and the extraction hole of each piece is detected

**Fig. 4** Designs of real and simulated setups in both lab and industrial environments

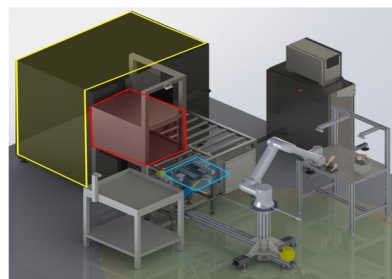

(a) Simulated robotic cell.



(b) Real robotic cell in the laboratory.

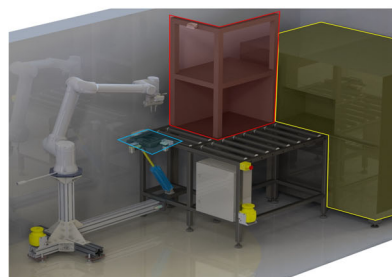

(c) Simulated robotic cell in the factory.



(d) Real robotic cell in the factory.

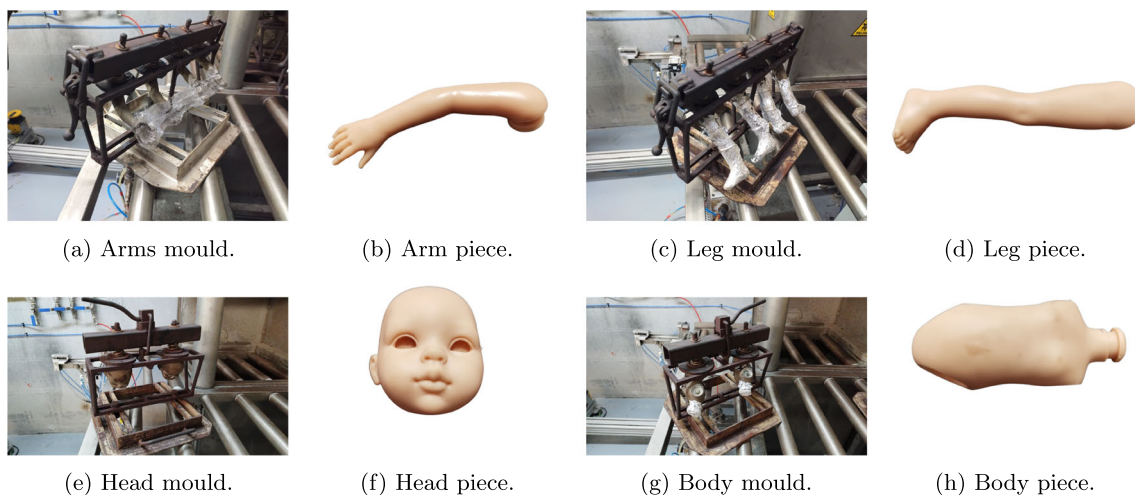

**Fig. 5** Moulds and pieces of different doll parts

and sent to the robot. Finally, the robot performs some defined force-based movements to extract the piece from the mould once the tip of the extraction tool reaches the extraction point.

### 3.3 Description of the system

The system is composed by three main devices: the UR10e robot, the PC, and the gripper. To define the communication between all of them, the PC is used as a hub. The gripper is connected to the PC by an IO-Link module. Using this configuration, it is possible to connect all mentioned devices and to use the PC as the core of the system. This allows to interconnect different libraries such as the vision, robotic, or communication networks ones.

#### Robot—PC

The XMLRPC library facilitates communication between the UR robot and the PC by establishing a server. This server enables the creation of Python functions on the PC that can be invoked from the robot, with execution occurring on the PC itself. This functionality grants us the flexibility to import various vision libraries like OpenCV or Open3D. In addition, this feature allows us to integrate ROS, making our system more robust by communicating with other devices in the robotic cell. Figure 6 presents the communication sys-

tem that explains how the robot sends requests to the PC, executes the functions related with the gripper, runs the perception module with the camera, and communicates with ROS messages. The PC then returns a value to the robot, that is the detected position to move.

#### Gripper—PC

The robotic gripper has been designed and developed by Zimmer GmbH. An IO-Link communication protocol master module has been integrated in order to establish communication between the PC and the gripper to read and write different registers to modify its parameters and drive it. Diagram representation of the integration is shown in Fig. 7.

As mentioned, by using this protocol, it is possible to write and read registers in order to set parameters or read them. The list of the configurable parameters is as follows:

- **Status word:** Read. These registers provide us information about the gripper such as if it is in motion, if the motors are on, and potential errors, among others.
- **Diagnosis:** Read. This shows the error ID.
- **Current position:** This shows the current position of the gripper.
- **Control word:** Read/write. The functionality of this register depends on the written value. One action is to

**Fig. 6** Communication system between the UR robot and the PC

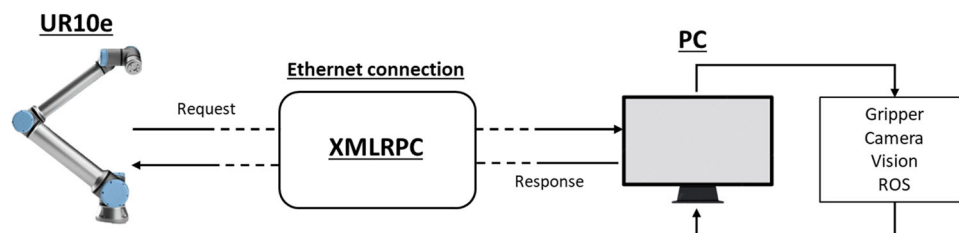
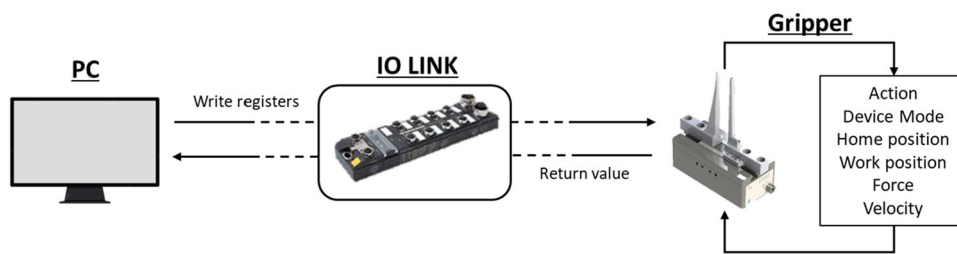

Fig. 7 Communication system between the gripper and the PC



transfer to the gripper the parameters written, and another is to send the command to close or open the gripper.

- **Device mode:** Read/write. This register sets the operation mode of the gripper. The gripper is able to work with different force profiles or just in position mode. Figure 8 shows an example of an operation profile.
- **Tolerance:** Read/write. Depending on the value of this register, the gripper assumes more or less error in the movements.
- **Force:** Read/write. Force was applied during the closing.
- **Velocity:** Read/write. Velocity of the movement.
- **Base, shift, teach, and work position:** Read/write. Positions values for the gripper from the opening to the closing position, passing through two intermediate positions.

Several operation modes have been defined in order to improve the dexterity of the gripper; however, Fig. 8 shows the used profile during the task execution.

This operation mode allows us to drive the gripper from the base position (gripper open) to the shift position by applying velocity, and once the gripper reaches that position, it changes to the force mode until it reaches the final work position. Figure 9 shows the design of the gripper and the fingers employed to demould the pieces.

The customized fingers are really important during the extraction task. One finger has a flat surface with a meshed pattern to secure the grip and prevent slipping of the piece, and the other finger is hollow, which allows us to integrate a

vacuum system. During the execution of the task, the robot will grip the piece by inserting the vacuum finger through the extraction hole. Then, the gripper closes, and the vacuum system starts to extract the air from inside the piece, separating it from the inner surface of the mould and making the task easier for the robot. This feature of the system forces us to develop an accurate extraction point detection algorithm to be able to automatically introduce the vacuum finger inside the piece.

ROS

As mentioned, the UR robot, PC, and grippers are the main devices of the system. However, there are other sensors and objects in the robotic cell that should be taken into account in order to perform the task. To manage all the information provided by those elements, the whole architecture has been integrated in ROS, allowing the communication between all the devices within the robotic cell.

ROS architecture allows to visualize in real time the robotic cell, robot trajectories, and the defined safety areas of the security devices, as shown in Fig. 10. In addition, ROS makes the communication between the robot and the safety laser scanners easier, reducing the risk for the operators while the robot is carrying out the task and applying high forces. Once the operator joins the warning area, the robot reduces the velocity of the movements, and if the operator is in the danger area, the robot stops completely, ensuring the safety of the workers.

Fig. 8 Pre-position—force operation mode

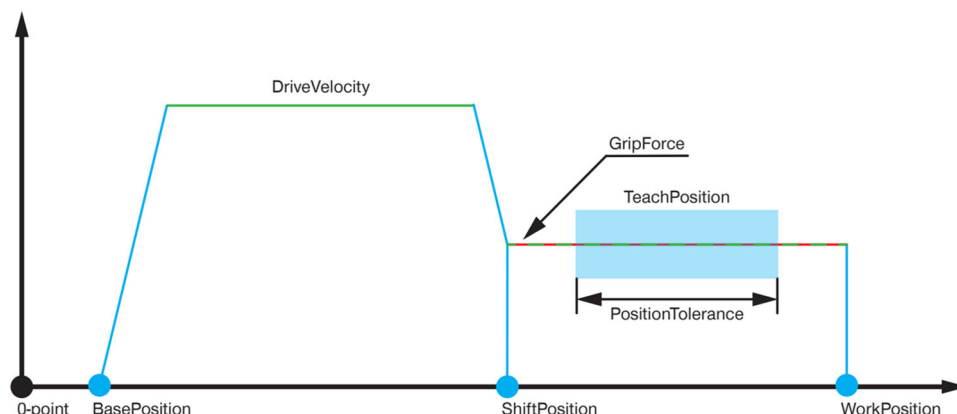

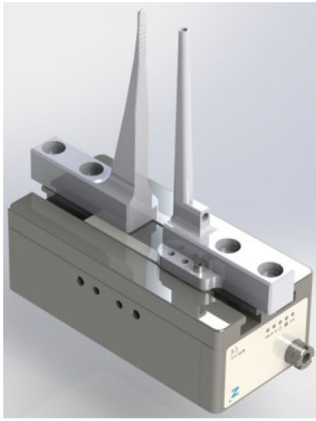

(a) CAD design of the gripper and fingers.



(b) Real gripper integrated in the robot.

**Fig. 9** Custom gripper designed for the task of demoulding doll parts

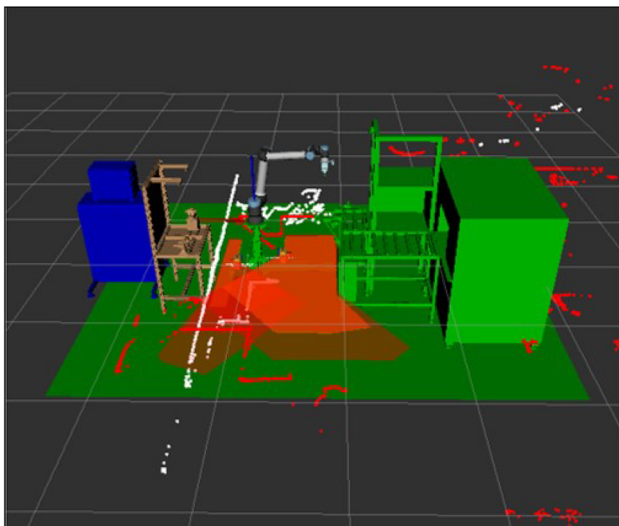

**Fig. 10** RVIZ real-time simulation of the robotic cell

### 3.4 Detection of mould landmarks

As explained previously, the rotomoulding manufacturing process is composed by different steps. One of them is the demoulding of the pieces which will be performed by the robot instead of the worker. To achieve this goal, a vision-based algorithm has been developed to detect the mould and the pieces inside. A Real Sense D435i 3D camera is used in the perception module in order to perform the detection of the different kinds of moulds and pieces to be demoulded. This whole process is explained in the Fig. 11.

As shown in Fig. 11, the goal of this module is to detect the extraction point of the piece inside the mould. The algorithm merges 2D and 3D information of the environment in order to remove unnecessary data and keep interesting areas. First of all, the 3D camera takes the point cloud of the environment. As the camera captures too many uninteresting points of the environment, this point cloud is segmented using a pass-through filter. As a result, the point cloud of the interest area, namely the mould, is retained, and the remaining ones are discarded. The next step is to apply RANSAC in order to detect the plane of the top of the mould where the piece is located. We used RANSAC over other plane-fitting algorithms due to its robustness against noise. As the RGB image and the point cloud are correlated, all the pixels from the image that do not lay in the detected plane are directly removed from the image. The result is the segmentation of the mould in the RGB image in which it is possible to detect the extraction point as shown in Fig. 11. Finally, the robot moves to the detected point to perform the demoulding, as shown in Fig. 12.

Finally, by integrating all previously mentioned devices and modules, this robotic cell is able to perform the demoulding task in the real industry environment as shown in Fig. 13.

## 4 Experiments and results

In this section, the results obtained in the automatic system of the demoulding task are shown in order to measure the success of the tasks performed by the developed system. The process has been split into three different sub-tasks: detection, grasping, and demoulding. As this is a sequential process, the output of the perception module is the input of the grasping module, and its output is the input of the demoulding module. In this way, failures are just considered in the current module and not in the next ones allowing us to measure the success and accuracy of the different modules of the system. For the detection and grasping module, own developers of the system checked at each cycle if the output is correct or not. However, the demoulding module is checked by the expert operator of the factory, due to their experience and knowledge of the final product.



Fig. 11 Diagram of the automatic demoulding pipeline

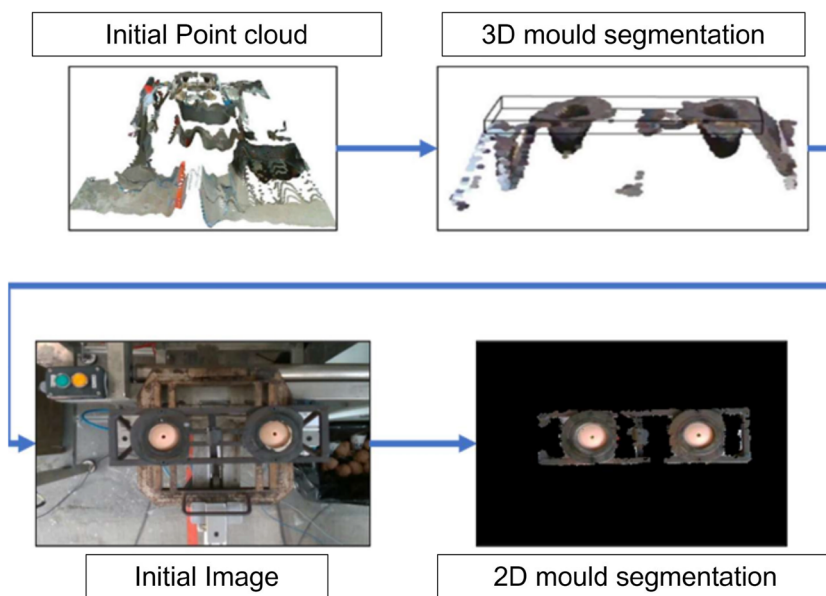

(a) Extraction point detection process.



(b) Extraction point detected.

In order to calculate the following production and quality metrics, 10 cycles of each mould have been carried out. A cycle considers the process from the time the robot removes the parts from the mould until the mould is returned to the demoulding area after the rotational moulding process.

- **Average probability of success (APS):** This value is obtained by dividing the number of successes ( $S$ ) by the number of total trials ( $N$ ), measured in percentage. This parameter will be calculated for each module separately (perception, grasping, and demoulding).

$$APS = \frac{S}{N} * 100 \tag{1}$$

- **Average time per (ATP) one piece demoulding:** This value is obtained by dividing the time the robot spends demoulding all the pieces of the mould ( $T$ ) by the number of pieces ( $N$ ), measured in seconds.

$$ATP = \frac{T}{N} \tag{2}$$

- **Average time per operation (ATPO):** ATPO is calculated by dividing the sum of all operations' time ( $T$ ) by the total number of operations ( $N$ ), measured in seconds. Operation term represents the unit of work that adds value to the production chain. In this case, two operations are considered: the rotomoulding process before the extraction (oven and cooling) and the extraction for all the moulds.

$$ATPO = \frac{\sum_{i=0}^N T_i}{N} \tag{3}$$



Fig. 12 Vacuum finger introduction

**Fig. 13** Real demoulding task performed by the robot (leg mould)

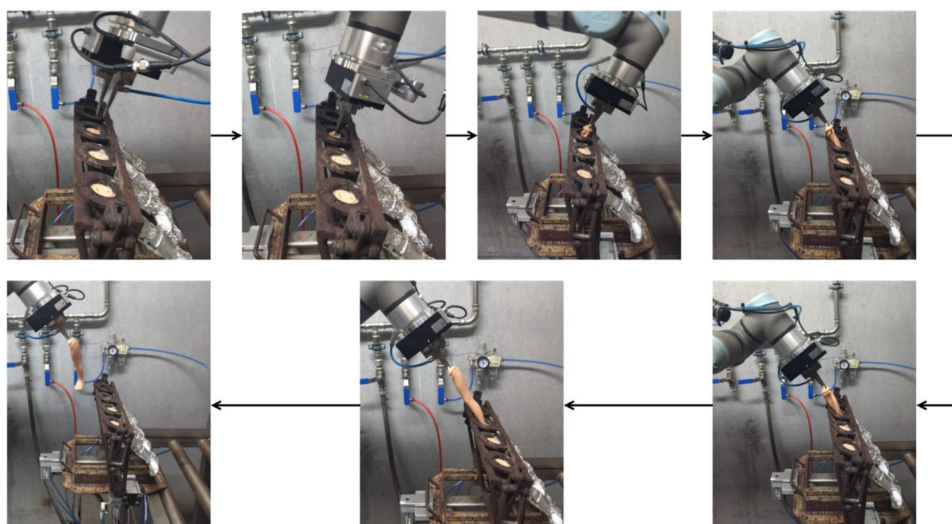

- **Number of trials per hour (NTPH):** The number of trials per hour can be calculated by ATPO.

$$NTPH = \frac{3600}{ATPO} \tag{4}$$

- **Mean operations per hour (MOPH):** Mean operations per hour is calculated by multiplying the average probability of success (APS) and the number of trials per hour.

$$MOPH = APS * NTPH \tag{5}$$

As mentioned previously, the system will perform the task in 10 complete cycles. Furthermore, in order to compare the system performance, the robot will carry out the task at 100%, 90%, and 80% of the maximum force (225 Newtons) and velocity (1000 mm/s) allowed for the robot. Next, tables (Tables 1, 2, and 3) show the results of the different tests carried out and the outcomes of the metrics. After 10 cycles, depending on the kind of piece/mould, the maximum number of pieces could be 20 (heads and bodies) or 40 (arms and legs).

Next, some conclusions are exposed from the results obtained in the experiments. The arm and leg parts are more difficult to demould than the other pieces due to their elongated shape, which makes the material more concentrated

and the piece more compact. This fact forces the system to carry out a two-step demoulding procedure for these pieces. Firstly, it is extracted the upper part of the piece in order to enable the airflow between the inner surface of the mould and the piece, thereby facilitating the extraction process. Afterwards, it is demoulded in the lower segment. Moreover, as the body part is the largest part, the robot needs to make more movements during demoulding, which means that it takes more time than the other parts. Finally, the headpiece is the easiest to demould due to its uniform and rounded shape. The headpiece also holds a large amount of air inside it, and the gripper fingers can apply vacuum and make the demoulding task easier. Given the diverse shapes of each piece, the robot follows varying paths during the demoulding process. Elongated pieces need supplementary movements to initially release the upper segment before demoulding the rest of the piece. Furthermore, the body and head are demoulded directly.

In general terms, it is possible to see a forward correlation between the percentage of force and velocity applied, and the APS (Eq. 1) which justifies that the demoulding task requires high effort by the operators. However, the APS of the detection module has no significant changes as it is independent of the velocity or force of the robot; it just depends on the camera. Finally, the grasping module changes because the

**Table 1** Results at 80% velocity and force

Pieces	Num. pieces	APS %			ATP (s)	ATPO	NTPH	MOPH
		Detection	Grasping	Demoulding				
Head	20	20 (100%)	17 (85%)	10 (58.8%)	9	1219.8	2.9514	1.125
Body	20	20 (100%)	16 (80%)	8 (50%)	11.5			
Leg	40	39 (97.5%)	36 (92.3%)	15 (41.7%)	10			
Arm	40	40 (100%)	38 (95%)	10 (26.3%)	9			

**Table 2** Results at 90% velocity and force

Pieces	Num. pieces	APS %			ATP (s)	ATPO	NTPH	MOPH
		Detection	Grasping	Demoulding				
Head	20	19 (95%)	18 (94.7%)	14 (77.8%)	7.5	1217.3	2.9574	1.978
Body	20	20 (100%)	16 (80%)	13 (81.3%)	10			
Leg	40	39 (97.5%)	37 (94.9%)	28 (75.7%)	8.5			
Arm	40	39 (97.5%)	37 (94.9%)	25 (67.6%)	8.5			

part is soft and flexible, so the robot spends too much time from detecting the parts until it grasps them; the parts may deform due to the lack of temperature.

As mentioned previously, APS (Eq. 1) metric measures the success of each module independently, and it is possible to see how it increases as force and velocity increase. However, the detection module is independent to the robot's performance, so it remains roughly constant. ATP (Eq. 2) metric has the same behaviour as the previous one as it is directly correlated with the force and velocity of the robot's performance. Meanwhile, the robot at 80% spends 9 s to demould 1 head, increasing 10% the time is reduced by 1.5 s, and finally, at 100% is 1 s faster still. In industrial processes in which machinery is working 24h, there is a production of 9600 heads at 80% in a day; in comparison with 13,292 heads at 100%, there is a huge difference for the company. ATPO (Eq. 3) and NTPH (Eq. 4) metrics are similar in the three cases as the time of the rotomoulding process and the cooling is included and they are constant; however, in 1 year period, the difference between the robot at 80% and 100% represents more than 1000 produced pieces. Finally, MOPH (Eq. 4) considers the APS (Eq. 1), and a huge difference is shown in the table between the 3 demoulding tests. From 80 to 90%, there is an 75.82% increase in performance, and from 90 to 100%, a 34.83%. These increments represent a remarkable production improvement in the long term. In the period of 1 year, the robot at 80% runs 9855 operations, and each operation is a complete cycle of each mould, which means 118,260 produced pieces, at 90% the robot produces 207,927 pieces, and at 100%, it produces 280,355 pieces. The difference of 20% is more than double the number of pieces produced in a year. In summary, conducting tests at different capacity levels provides a holistic understanding of a

robot's performance, safety margins, efficiency, result validity, and adaptability. This approach ensures that the robot's capabilities are thoroughly examined and validated for both optimal performance and safe operation, while also accounting for potential changes in operational conditions over time.

Finally, Fig. 14 illustrates the trajectories traced by the robot during the demoulding process of the headpiece. This visual representation offers a valuable perspective on the movements and displacements the robot has performed in its environment. The 3D graph provides a better understanding of the relationship between the position of the robot and the force applied by the robotic tool. The blue line represents the position of the robot along the task path, and the red circles represent the amount of force obtained from the robotic tool (the larger the size, the more force).

As shown in Fig. 14, once the detection algorithm provides the piece extraction point, the robot moves to the mould and performs the trajectories to grip the piece and demould it. The trajectory begins at the 'Init' marker. Subsequently, the robot moves forward to point 'A', which designates the detected extraction point of the headpiece. Following this, the robot executes a rotation movement applying force at point 'B', where it grasps the piece using the gripper. Finally, the robot moves from 'B' to 'C' and performs an upward pull to successfully extract the piece from the mould. Larger circles appear when the robot grasps, rotates, and pulls up to remove the piece. However, the amount of force provided by the robot is only the one detected in the end effector, not in all the joints. For a better understanding of the task performance data, Fig. 15 shows the end effector positions and orientations of the robot, as well as the forces during the demoulding task. These values are shown along an iteration axis.

**Table 3** Results at 100% velocity and force

Pieces	Num. pieces	APS %			ATP (s)	ATPO	NTPH	MOPH
		Detection	Grasping	Demoulding				
Head	20	19 (95%)	19 (100%)	19 (100%)	6.5	1214.75	2.9635	2.667
Body	20	20 (100%)	18 (90%)	18 (100%)	8			
Leg	40	40 (100%)	40 (100%)	37 (92.5%)	7.5			
Arm	40	39 (97.5%)	37 (94.9%)	33 (89.2%)	7.5			

**Fig. 14** Trajectory of the robot during the demoulding task of a head piece

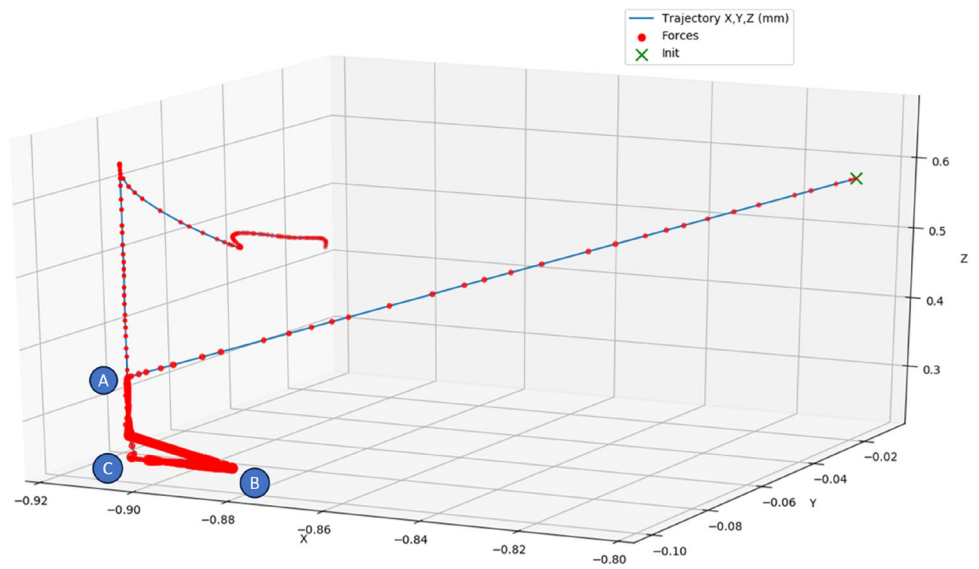

Upon comparing both previous plots (Figs. 14 and 15), the relationship among points ‘A’, ‘B’, and ‘C’ becomes apparent. The robot initiates movement moving to point ‘A’, where the orientation and position stabilize at constant values; then, the position undergoes a brief alteration while the force demonstrates an upward trend. Subsequently, the robot pivots and advances with force application upon reaching point ‘B’, coinciding with the Z-axis rotation matching that

of the initial point. Lastly, as the robot reaches point ‘C’, it pulls upward, revealing both positional and force elevation along the Z-axis. Summarizing, while extracting the piece from the mould, the end effector records a force that surpasses 40 N. This implies that the other joints are also subjected to higher force magnitudes. Consequently, it is evident that the robot must use its full capacity, even operating near its limits, to successfully execute the demoulding process.

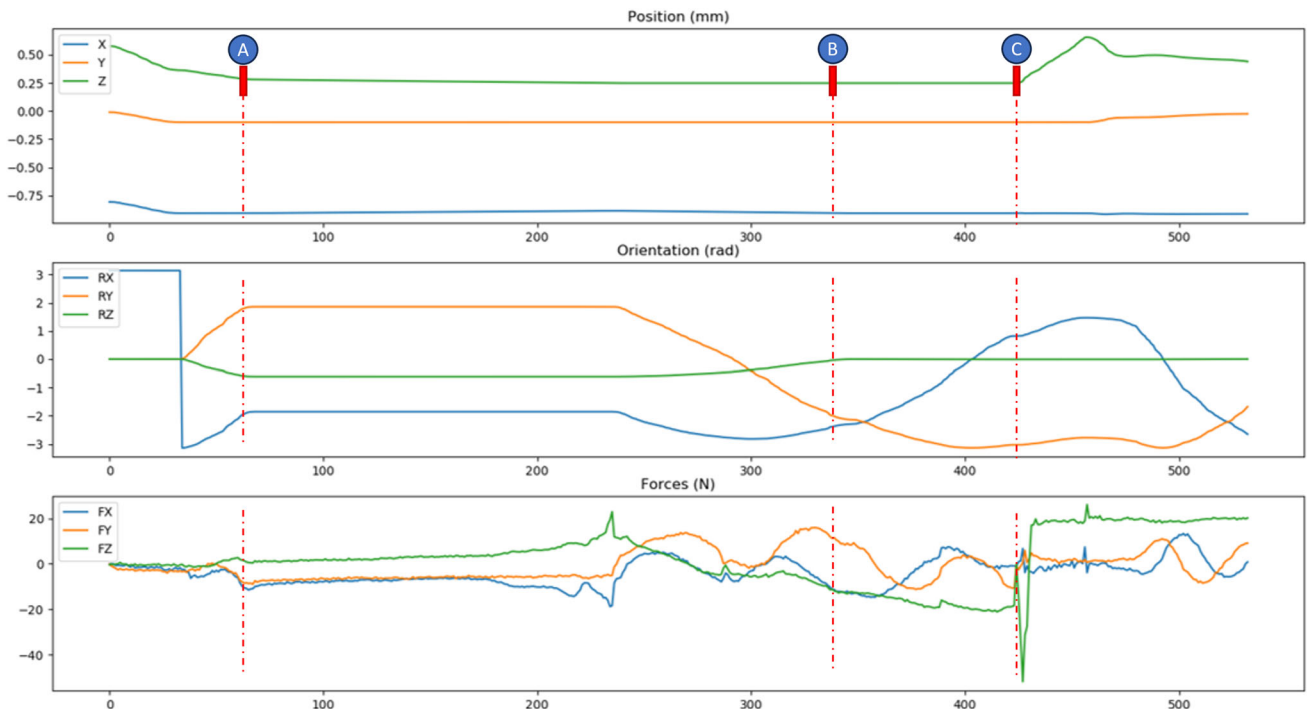

**Fig. 15** Positions, orientations, and forces of the robot during the demoulding task of a head piece

## 5 Conclusion and future work

In conclusion, this work proposes a new automatic and collaborative robotic system able to perform the demoulding task of soft plastic pieces in a real industrial environment of a doll manufacturing company. This system is based on a vision algorithm to detect the moulds and the extraction point of the pieces to send them to the robot and perform the demoulding. The force requirement of this task is a challenge for a collaborative robot; however, by executing similar trajectories to the expert operators, it is possible to carry out the task correctly.

Finally, this collaborative task allows operators to perform other tasks that require more dexterity while the robot performs the task, avoiding injuries. The results show us the success rate of the system, which makes it useful for the company, provides an increase in production, and serves as the first step for the technological transference for small companies.

**Funding** Open Access funding provided thanks to the CRUE-CSIC agreement with Springer Nature. This work has been carried out within the scope of an Industrial PhD at AIJU in the context of the SOFTMAN-BOT Project, with European funding from the Horizon 2022 research programme (G.A 869855). In addition, it has been supported by the UAIND21-06B grant of the University of Alicante.

## Declarations

**Competing interests** The authors declare no competing interests.

**Open Access** This article is licensed under a Creative Commons Attribution 4.0 International License, which permits use, sharing, adaptation, distribution and reproduction in any medium or format, as long as you give appropriate credit to the original author(s) and the source, provide a link to the Creative Commons licence, and indicate if changes were made. The images or other third party material in this article are included in the article's Creative Commons licence, unless indicated otherwise in a credit line to the material. If material is not included in the article's Creative Commons licence and your intended use is not permitted by statutory regulation or exceeds the permitted use, you will need to obtain permission directly from the copyright holder. To view a copy of this licence, visit <http://creativecommons.org/licenses/by/4.0/>.

## References

- (2021) Robotic manipulation system for multi-layer fabric stitching, International design engineering technical conferences and computers and information in engineering conference, vol 7: 17th IEEE/ASME International conference on mechatronic and embedded systems and applications (MESA), v007T07A037
- Al-Yacoub A, Zhao Y, Eaton W et al (2021) Improving human robot collaboration through force/torque based learning for object manipulation. *Robot Comput -Integr Manuf* 69:102111
- Arents J, Greitans M (2022) Smart industrial robot control trends, challenges and opportunities within manufacturing. *Appl Sci* 12(2)
- Argall BD, Browning B, Veloso M (2008) Learning robot motion control with demonstration and advice-operators. In: 2008 IEEE/RSJ international conference on intelligent robots and systems. p 399–404
- Argall BD, Chernova S, Veloso M et al (2009) A survey of robot learning from demonstration. *Robot Auton Syst* 57(5):469–483
- Daniel Zakaria MH, Aranda M, Lequière L et al (2022) Robotic control of the deformation of soft linear objects using deep reinforcement learning. In: 2022 IEEE 18th international conference on automation science and engineering (CASE). pp 1516–1522
- Elguea-Aguinaco Íñigo, Serrano-Muñoz A, Chrysostomou D et al (2023) A review on reinforcement learning for contact-rich robotic manipulation tasks. *Robot Comput-Integr Manuf* 81:102517
- Gao Y, Chen Z, Fang M et al (2020) Development of an autonomous soldering robot for USB wires. In: 2020 IEEE/ASME international conference on advanced intelligent mechatronics (AIM). pp 1196–1201
- Jiménez P (2012) Survey on model-based manipulation planning of deformable objects. *Robot Comput -Integr Manuf* 28(2):154–163
- Koessler A, Filella NR, Bouzgarrou B et al (2021) An efficient approach to closed-loop shape control of deformable objects using finite element models. In: 2021 IEEE International conference on robotics and automation (ICRA). pp 1637–1643
- Lagneau R, Krupa A, Marchal M (2020) Automatic shape control of deformable wires based on model-free visual servoing. *IEEE Robot Autom Lett* 5(4):5252–5259
- Liu Z, Liu Q, Xu W et al (2022) Robot learning towards smart robotic manufacturing: a review. *Robot Comput -Integr Manuf* 77:102360
- Lopes A, Almeida F (2008) A force-impedance controlled industrial robot using an active robotic auxiliary device. *Robot Comput -Integr Manuf* 24(3):299–309
- Mercado-Colmenero JM, Rubio-Paramio M, Vizán-Idoipe A et al (2017) A new procedure for the automated design of ejection systems in injection molds. *Robot Comput -Integr Manuf* 46:68–85
- Pedersen MR, Nalpantidis L, Andersen RS et al (2016) Robot skills for manufacturing: from concept to industrial deployment. *Robot Comput -Integr Manuf* 37:282–291
- Ubeda RP, Gutiérrez Rubert SC, Stanisic RZ et al (2021) Behavioural study of the force control loop used in a collaborative robot for sanding materials. *Materials* 14(1)
- Vogel C, Fritzsche M, Elkmann N (2016) Safe human-robot cooperation with high-payload robots in industrial applications. In: 2016 11th ACM/IEEE international conference on Human-Robot Interaction (HRI). pp 529–530
- Wilson M (2010) Developments in robot applications for food manufacturing. *Ind Robot* 37(6):498–502
- Yang X, Zhou Z, Sørensen JH et al (2023) Automation of SME production with a Cobot system powered by learning-based vision. *Robot Comput-Integr Manuf* 83:102564

**Publisher's Note** Springer Nature remains neutral with regard to jurisdictional claims in published maps and institutional affiliations.