

Chapter 2

Polymer Size and Polymer Solutions

The size of single polymer chain is dependent on its molecular weight and morphology. The morphology of a single polymer chain is determined by its chemical structure and its environment. The polymer chain can be fully extended in a very dilute solution when a good solvent is used to dissolve the polymer. However, the single polymer chain is usually in coil form in solution due to the balanced interactions with solvent and polymer itself. We will discuss the size of polymer first, and then go to the coil formation in the polymer solution.

2.1 The Molecular Weight of Polymer

The molecular weight of polymer determines the mechanical properties of polymers. To have strong durable mechanical properties, the polymer has to have molecular weight much larger than 10,000 for structural applications. However, for thin film or other special application, low molecular weight polymer or oligomer sometime is adequate. As shown in Fig. 2.1, above (A), strength increases rapidly with molecular weight until a critical point (B) is reached. Mechanical strength increases more slowly above (B) and eventually reaches a limiting value (C). High molecular weight polymer has high viscosity and poor processability. The control of molecular weight and molecular weight distribution (MWD) is often used to obtain and improve certain desired physical properties in a polymer product.

Polymers, in their purest form, are mixtures of molecules of different molecular weights. The reason for the polydispersity of polymers lies in the statistical variations present in the polymerization processes. The above statement is true for common polymerization reaction such as free radical chain polymerization, step polymerization, etc. However, cationic or anionic chain polymerization as so called living polymerization has small MWD. Low dispersity can also be obtained from emulsion polymerization, and new polymerization techniques such as living free radical polymerization including nitroxide-mediated polymerization (NMP), atom transfer radical polymerization (ATRP), and reversible addition–fragmentation chain

Fig. 2.1 Dependence of mechanical strength on polymer molecular weight [1]

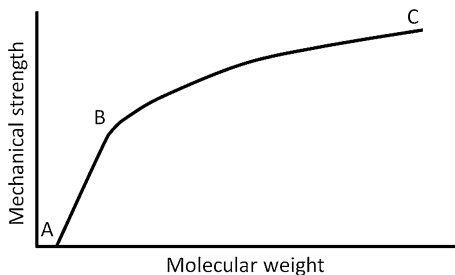

transfer polymerization (RAFT). The chemistry of different polymerization reactions will be discussed in detail in the subsequent chapters.

Number-average molecular weight (\bar{M}_n) is total weight (W) of all the molecules in a polymer sample divided by the total number of molecule present, as shown in Eq. 2.1, where N_x is the number of molecules of size M_x , \underline{N}_x is number (mole) fraction of size M_x

$$\bar{M}_n = W/\sum N_x = \sum N_x M_x / \sum N_x = \sum \underline{N}_x M_x \quad (2.1)$$

Analytical methods used to determine \bar{M}_n include (1) $\bar{M}_n < 25,000$ by vapor pressure osmometry, (2) \bar{M}_n 50,000–2 million by membrane osmometry, and (3) $\bar{M}_n < 50,000$ by end group analysis, such as NMR for $-C=C-$; titration for carboxylic acid ending group of polyester. They measure the colligative properties of polymer solutions. The colligative properties are the same for small and large molecules when comparing solutions at the same mole fraction concentration. Therefore, the \bar{M}_n is biased toward smaller sized molecules. The detailed measurement methods of molecular weight will be discussed in Sect. 2.3. Weight-average molecular weight is defined as Eq. 2.2, where W_x is the weight fraction of M_x molecules, C_x is the weight concentration of M_x molecules, and C is the total weight concentration of all of the polymer molecules, and defined by Eqs. 2.3–2.5.

$$\bar{M}_w = \sum W_x M_x = \sum C_x M_x / \sum C_x \quad (2.2)$$

$$W_x = C_x / C \quad (2.3)$$

$$C_x = N_x M_x \quad (2.4)$$

$$C = \sum C_x = \sum N_x M_x \quad (2.5)$$

Light scattering is an analytical method to determine the \bar{M}_w in the range of 10,000–10,000,000. It unlike colligative properties shows a greater number for larger sized molecules than for small-sized molecules. Viscosity-average molecular weight (\bar{M}_v) is defined as Eq. 2.6, where a is a constant. The viscosity and

weight average molecular weights are equal when a is unity. \bar{M}_v is like \bar{M}_w , it is greater for the larger sized polymer molecules than for smaller ones.

$$\bar{M}_v = [\sum M_x^a W_x]^{1/a} = [\sum N_x M_x^{a+1} / \sum N_x M_x]^{1/a} \quad (2.6)$$

A measure of the polydispersity in a polymer is defined as \bar{M}_w divided over \bar{M}_n (\bar{M}_w/\bar{M}_n). For a polydispersed polymer, $\bar{M}_w > \bar{M}_v > \bar{M}_n$ with the differences between the various average molecular weights increasing as the molecular-weight distribution (MWD) broadens, as shown in Fig. 2.2.

For example, consider a hypothetical mixture containing 95 % by weight of molecules of molecular weight 10,000, and 5 % of molecules of molecular weight 100. The \bar{M}_n and \bar{M}_w are calculated from Eqs. 2.1 and 2.2 as 1,680 and 9,505, respectively. The use of the \bar{M}_n value of 1,680 gives an inaccurate indication of the properties of this polymer. The properties of the polymer are determined primarily by the molecules with a molecular weight of 10,000 that makes up 95 % of the weight of the mixture. The highest % fraction of molecular weight of molecule will contribute the most toward the bulk property. It is desirable to know the molecular weight distribution, then to predict the polymer properties. At present, the gel permeation chromatography (GPC) technique has been advanced to be able to easily measure \bar{M}_n , \bar{M}_v , \bar{M}_w , simultaneously and calculate PDI using only one sample. All the measurements of molecular weight of polymers are carried out using polymer solutions. Therefore, the accuracy of molecular weight measurement is dependent on the behavior of polymer solution. Usually, a calibration curve is established first using a specific polymer dissolving in a specific solvent. Polystyrene standard dissolved in tetrahydrofuran (THF) is the most popular calibration curve used in GPC. If the measured polymer exhibits different behavior in THF from that of polystyrene, then a deviation from the actual molecular weight is occurred. For example, a conducting polymer, poly (phenylene vinylene), containing rigid rod molecular structure shows a higher molecular weight when the standard of coil structured polystyrene is used. More detailed discussion of GPC is in Sect. 2.3.

Fig. 2.2 Distribution of molecular weights in a typical polymer sample [1]

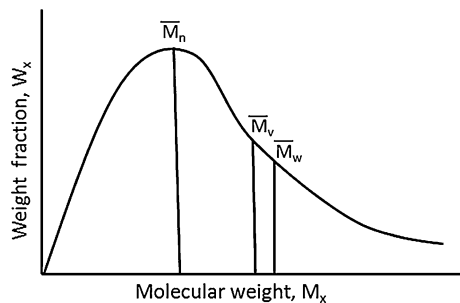

2.2 Polymer Solutions

Polymer solutions occur in two stages. Initially, the solvent molecules diffuse through the polymer matrix to form a swollen, solvated mass called a gel. In the second stage, the gel breaks up and the molecules are dispersed into a true solution. Not all polymers can form true solution in solvent.

Detailed studies of polymer solubility using thermodynamic principles have led to semi-empirical relationships for predicting the solubility [2]. Any solution process is governed by the free-energy relationship of Eq. 2.7:

$$\Delta G = \Delta H - T\Delta S \quad (2.7)$$

When a polymer dissolves spontaneously, the free energy of solution, ΔG , is negative. The entropy of solution, ΔS , has a positive value arising from increased conformational mobility of the polymer chains. Therefore, the magnitude of the enthalpy of solution, ΔH , determines the sign of ΔG . It has been proposed that the heat of mixing, ΔH_{mix} , for a binary system is related to concentration and energy parameters by Eq. 2.8:

$$\Delta H_{mix} = V_{mix} \left[\left(\frac{\Delta E_1}{V_1} \right)^{1/2} - \left(\frac{\Delta E_2}{V_2} \right)^{1/2} \right]^2 \phi_1 \phi_2 \quad (2.8)$$

where V_{mix} is the total volume of the mixture, V_1 and V_2 are molar volumes (molecular weight/density) of the two components, ϕ_1 and ϕ_2 are their volume fractions, and ΔE_1 and ΔE_2 are the energies of vaporization. The terms $\Delta E_1/V_1$ and $\Delta E_2/V_2$ are called the *cohesive energy densities*. If $(\Delta E/V)^{1/2}$ is replaced by the symbol δ , the equation can be simplified into Eq. 2.9:

$$\Delta H_{mix} = V_{mix}(\delta_1 - \delta_2)^2 \phi_1 \phi_2 \quad (2.9)$$

The interaction parameter between polymer and solvent can be estimated from ΔH_{mix} as:

$$\chi_{12} = \frac{V_1}{RT} (\delta_1 - \delta_2)^2 \quad (2.10)$$

The symbol δ is called the solubility parameter. Clearly, for the polymer to dissolve (negative ΔG), ΔH_{mix} must be small; therefore, $(\delta_1 - \delta_2)^2$ must also be small. In other words, δ_1 and δ_2 should be of about equal magnitude where $\delta_1 = \delta_2$, solubility is governed solely by entropy effects. Predictions of solubility are therefore based on finding solvents and polymers with similar solubility parameters, which requires a means of determining cohesive energy densities.

Cohesive energy density is the energy needed to remove a molecule from its nearest neighbors, thus is analogous to the heat of vaporization per volume for a

volatile compound. For the solvent, δ_1 can be calculated directly from the latent heat of vaporization (ΔH_{vap}) using the relationship of Eq. 2.11:

$$\Delta E = \Delta H_{vap} - RT \quad (2.11)$$

R is the gas constant, and T is the temperature in kelvins. Thus, the cohesive energy of solvent is shown in Eq. 2.12:

$$\delta_1 = \left(\frac{\Delta H_{vap} - RT}{V} \right)^{1/2} \quad (2.12)$$

Since polymers have negligible vapor pressure, the most convenient method of determining δ_2 is to use group molar attraction constants. These are constants derived from studies of low-molecular-weight compounds that lead to numerical values for various molecular groupings on the basis of intermolecular forces. Two sets of values (designated G) have been suggested, one by Small [3], derived from heats of vaporization and the other by Hoy [4], based on vapor pressure measurements. Typical G values are given in Table 2.1. Clearly there are significant differences between the Small and Hoy values. The use of which set is normally determined by the method used to determine δ_1 for the solvent.

G values are additive for a given structure, and are related to δ by

$$\delta = \frac{d \Sigma G}{M} \quad (2.13)$$

where d is density and M is molecular weight. For polystyrene $-\text{[CH}_2\text{-CH(C}_6\text{H}_5\text{)]}_n\text{-}$, for example, which has a density of 1.05, a repeating unit mass of 104, and δ is calculated, using Small's G values, as

Table 2.1 Representative group molar attraction constants [3, 4]

Chemical group	$G[(\text{cal cm}^3)^{1/2}\text{mol}^{-1}]$	
	Small	Hoy
$\text{H}_3\text{C}-$	214	147.3
$- \text{CH}_2 -$	133	131.5
$\begin{array}{c} \diagup \\ \text{CH}- \\ \diagdown \end{array}$	28	86.0
$\begin{array}{c} \diagup \\ \text{C} \\ \diagdown \end{array}$	-93	32.0
$=\text{CH}_2$	190	126.0
$=\text{CH}-$	19	84.5
$- \text{C}_6\text{H}_5$ (phenyl)	735	-
$- \text{CH} =$ (aromatic)	-	117.1
$\begin{array}{c} \diagup \\ \text{C} = \text{O} \\ \diagdown \end{array}$ (ketone)	275	262.7
$-\text{CO}_2-$ (ester)	310	326.6

$$\delta = \frac{1.05(133 + 28 + 735)}{104} = 9.0$$

or using Hoy's data,

$$\delta = \frac{1.05[131.5 + 85.99 + 6(117.1)]}{104} = 9.3$$

Both data give similar solubility parameter. However, there is limitation of solubility parameter. They do not consider the strong dipolar forces such as hydrogen bonding, dipole–dipole attraction, etc. Modifications have been done by many researchers and available in literature [5, 6].

Once a polymer–solvent system has been selected, another consideration is how the polymer molecules behave in that solvent. Particularly important from the standpoint of molecular weight determinations is the resultant size, or *hydrodynamic volume*, of the polymer molecules in solution. Assuming polymer molecules of a given molecular weight are fully separated from one another by solvent, the hydrodynamic volume will depend on a variety of factors, including interactions between solvent and polymer molecules, chain branching, conformational effects arising from the polarity, and steric bulkiness of the substituent groups, and restricted rotation caused by resonance, for example, polyamide can exhibit resonance structure between neutral molecule and ionic molecule.



Because of Brownian motion, molecules are changing shape continuously. Hence, the prediction of molecular size must base on statistical considerations and average dimensions. If a molecule was fully extended, its size could easily be computed from the knowledge of bond lengths and bond angles. Such is not the case, however, with most common polymers; therefore, size is generally expressed

Fig. 2.3 Schematic representation of a molecular coil, r = end to end distance, s = radius of gyration [2]

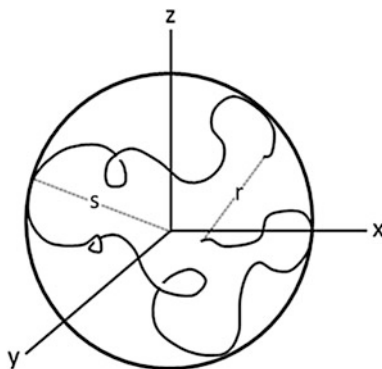

in terms of the mean-square average distance between chain ends, \bar{r}^2 , for a linear polymer, or the square average radius of gyration about the center of gravity, \bar{s}^2 , for a branched polymer. Figure 2.3 illustrates the meaning of r and s from the perspective of a coiled structure of an individual polymer molecule having its center of gravity at the origin.

The average shape of the coiled molecule is spherical. The greater the affinity of solvent for polymer, the larger will be the sphere, that is, the hydrodynamic volume. As the solvent–polymer interaction decreases, intramolecular interactions become more important, leading to a contraction of the hydrodynamic volume. It is convenient to express r and s in terms of two factors: an unperturbed dimension (r_0 or s_0) and an expansion factor (α). Thus,

$$\bar{r}^2 = r_0^2 \alpha^2 \quad (2.14)$$

$$\bar{s}^2 = s_0^2 \alpha^2 \quad (2.15)$$

$$\alpha = \frac{(\bar{r}^2)^{1/2}}{(\bar{r}_0^2)^{1/2}} \quad (2.16)$$

The unperturbed dimension refers to the size of the macromolecule exclusive of solvent effects. It arises from a combination of free rotation and intramolecular interactions such as steric and polar interactions. The expansion factor, on the other hand, arises from interactions between solvent and polymer. For a linear polymer, $\bar{r}^2 = 6\bar{s}^2$. The α will be greater than unity in a “good” solvent, thus the actual (perturbed) dimensions will exceed the unperturbed dimensions. The greater the value of α is, the “better” the solvent is. For the special case where $\alpha = 1$, the polymer assumes its unperturbed dimensions and behaves as an “ideal” statistical coil.

Because solubility properties vary with temperature in a given solvent, α is temperature dependent. For a given polymer in a given solvent, the lowest temperature at which $\alpha = 1$ is called the theta (θ) temperature (or Flory temperature), and the solvent is then called a theta solvent. Additionally, the polymer is said to be in a theta state. In the theta state, the polymer is on the brink of becoming insoluble; in other words, the solvent is having a minimal solvation effect on the dissolved molecules. Any further diminish of this effect causes the attractive forces among polymer molecules to predominate, and the polymer precipitates.

From the standpoint of molecular weight determinations, the significance of solution viscosity is expressed according to the Flory-Fox equation [7],

$$[\eta] = \frac{\Phi(\bar{r}^2)^{3/2}}{M} \quad (2.17)$$

where $[\eta]$ is the intrinsic viscosity (to be defined later), \bar{M} is the average molecular weight, and Φ is a proportionality constant (called the Flory constant) equal to

approximately 3×10^{24} . Substituting $\bar{r}_0^2 \alpha^2$ for \bar{r}^2 , we obtain Mark-Houwink-Sakurada equation:

$$[\eta] = \frac{\Phi (\bar{r}_0^2 \alpha^2)^{3/2}}{M} \quad (2.18)$$

Equation 2.18 can be rearranged to

$$[\eta] = \Phi (\bar{r}_0^2 \bar{M}^{-1})^{3/2} \bar{M}^{1/2} \alpha^3 \quad (2.19)$$

Since \bar{r}_0 and \bar{M} are constants, we can set $K = \Phi (\bar{r}_0^2 \bar{M}^{-1})^{3/2}$, then

$$[\eta] = K \bar{M}^{1/2} \alpha^3 \quad (2.20)$$

At the theta temperature, $\alpha = 1$ and

$$[\eta] = K \bar{M}^{1/2} \quad (2.21)$$

For conditions other than the theta temperature, the equation is expressed by

$$[\eta] = K \bar{M}^a \quad (2.22)$$

Apart from molecular weight determinations, many important practical considerations are arisen from solubility effects. For instance, one moves in the direction of “good” solvent to “poor”, and intramolecular forces become more important, the polymer molecules shrink in volume. This increasing compactness leads to reduced “drag” and hence a lower viscosity which has been used to control the viscosity of polymer for ease of processing.

2.3 Measurement of Molecular Weight

Many techniques have been developed to determine the molecular weight of polymer [8]. Which technique to use is dependent on many factors such as the size of the polymer, the ease of access and operation of the equipment, the cost of the analysis, and so on.

For polymer molecular weight is less than 50,000, its molecular weight can be determined by the end group analysis. The methods for end group analysis include titration, elemental analysis, radio active tagging, and spectroscopy. Infrared spectroscopy (IR), nuclear magnetic resonance spectroscopy (NMR), and mass spectroscopy (MS) are commonly used spectroscopic technique. The IR and NMR are usually less sensitive than that of MS due to the detection limit.

Rules of end group analysis for \bar{M}_n are: (1) the method cannot be applied to branched polymers unless the number of branches is known with certainty; thus it is practically limited to linear polymers, (2) in a linear polymer there are twice as

many end groups as polymer molecules, (3) if the polymer contains different groups at each end of the chain and only one characteristic end group is being measured, the number of this type is equal to the number of polymer molecules, (4) measurement of molecular weight by end-group analysis is only meaningful when the mechanisms of initiation and termination are well understood. To determine the number average molecular weight of the linear polyester before cross-linking, one can titrate the carboxyl and hydroxyl end groups by standard acid–base titration methods. In the case of carboxyl, a weighed sample of polymer is dissolved in an appropriate solvent such as acetone and titrated with standard base to a phenolphthalein end point. For hydroxyl, a sample is acetylated with excess acetic anhydride, and liberated acetic acid, together with carboxyl end groups, is similarly titrated. From the two titrations, one obtains the number of mini-equivalents of carboxyl and hydroxyl in the sample. The number average molecular weight (i.e., the number of grams per mole) is then given by Eq. 2.23:

$$\bar{M}_n = \frac{2 \times 1000 \times \text{sample wt.}}{\text{meqCOOH} + \text{meqOH}} \quad (2.23)$$

The 2 in the numerator takes into account that two end groups are being counted per molecule. The *acid number* is defined as the number of milligrams of base required to neutralize 1 g of polyester which is used to monitor the progress of polyester synthesis in industry.

Of the various methods of number average molecular weight determination based on colligative properties, membrane osmometry is most useful. When pure solvent is

Fig. 2.4 Schematic representation of a membrane osmometer [2]

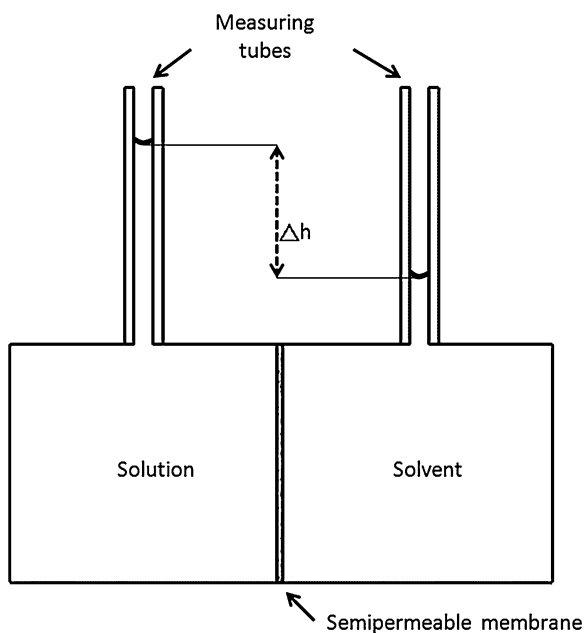

separated from a solution by a semi-permeable membrane that allows passage of solvent but not solute molecules, solvent will flow through the membrane into the solution. As the liquid level rises in the solution compartment, the hydrostatic pressure increases until it prevents further passage of solvent or, more exactly, until solvent flow is equal in both directions. The pressure at equilibrium is the osmotic pressure. A schematic representation of an osmometer is given in Fig. 2.4.

Osmotic pressure is related to molecular weight by the van't Hoff equation extrapolated to zero concentration:

$$\left(\frac{\pi}{C}\right)_{c=0} = \frac{RT}{M_n} + A_2C \quad (2.24)$$

where π , the osmotic pressure, is given by

$$\pi = \rho g \Delta h \quad (2.25)$$

where R is the gas constant, $0.082 \text{ L atm mol}^{-1}\text{K}^{-1}$ (CGS) or $8.314 \text{ J mol}^{-1}\text{K}^{-1}$ (SI); T is the temperature in kelvins; C is the concentration in grams per liter; ρ is the solvent density in grams per cubic centimeter, g is the acceleration due to gravity, 9.81 m/s^2 ; Δh is the difference in heights of solvent and solution in centimeters; and A_2 is the second virial coefficient (a measure of the interaction between solvent and polymer). A plot of *reduced osmotic pressure*, π/C , versus concentration (Fig. 2.5) is linear with the intercept equal to RT/M_n and the slope equal to A_2 , units for π/C are $\text{dyn Lg}^{-1}\text{cm}^{-1}$ (CGS) or Jkg^{-1} (SI). Because A_2 is a measure of solvent-polymer interaction, the slope is zero at the theta temperature. Thus osmotic pressure measurements may be used to determine theta conditions.

Matrix assisted laser desorption ionization-time of flight mass spectrometry (MALDI-TOF MS) is developed recently to determine the absolute molecular weight of large molecule. The polymer sample is imbedded in a low molecular weight organic compound that absorbs strongly at the wavelength of a UV laser. Upon UV radiation, organic compound absorbs energy, then energy transfer to polymer to form ions. Finally, the ions are detected. At higher molecular weight, the signal to noise ratio is reduced. From the integrated peak areas, reflecting the number of ions (N_j) and the average molecular weight (M_i), both \bar{M}_n and \bar{M}_w can be calculated. Figure 2.6 shows that a low molecular weight ($\bar{M}_w \sim 3,000$) poly(3-

Fig. 2.5 Plot of reduced osmotic pressure versus concentration [2]

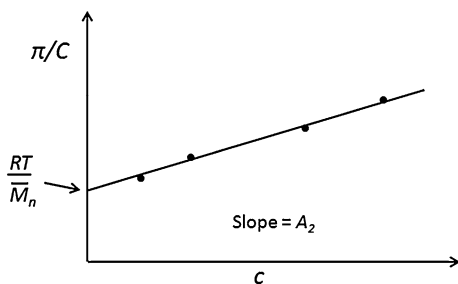

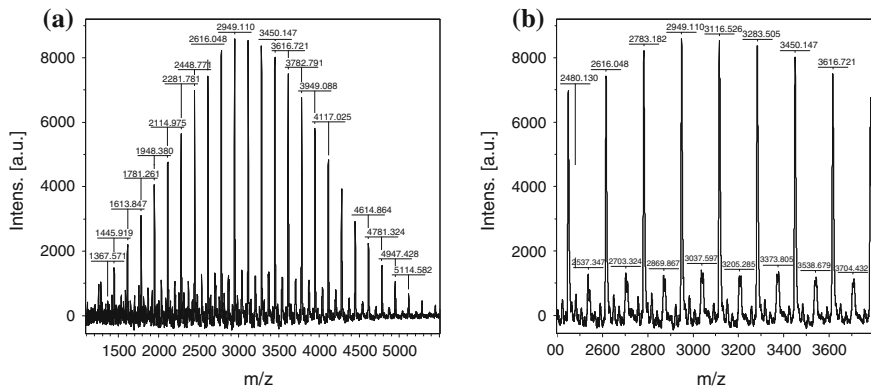

Fig. 2.6 MALDI mass spectrum of low molecular weight poly(3-hexyl thiophene) (a) whole spectrum, (b) magnified area between m/z 2,400 and 3,800

hexyl thiophene) was measured by MALDI-TOF MS. The spectrum shows the molecular weight distribution and the difference between every peak is equal to the repeating unit 3-hexyl thiophene of 167.

The absolute weight average molecular weight (\bar{M}_w) can also be measured by light scattering method. The light passes through the solution, loses energy by absorption, conversion to heat, and scattering. The intensity of scattered light depends on concentration, size, polarizability of the scattering molecules. To evaluate the turbidity arising from scattering, one combines equations derived from scattering and index of refraction measurements. Turbidity, τ , is related to concentration, c , by the expression

$$\tau = Hc\bar{M}_w \quad (2.26)$$

where H is

$$H = \frac{32\pi^3 n_0^2 (dn/dc)^2}{3 \lambda^4 N_0} \quad (2.27)$$

and n_0 is the refractive index of the solvent, λ is the wavelength of the incident light, and N_0 is Avogadro's number. The expression dn/dc , referred to as the *specific refractive increment*, is obtained by measuring the slope of the refractive index as a function of concentration, and it is constant for a given polymer, solvent, and temperature. As molecular size approaches the magnitude of light wavelength, corrections must be made for interference between scattered light coming from different parts of the molecules. To determine molecular weight, the expression for turbidity is rewritten as

$$\frac{Hc}{\tau} = \frac{1}{\bar{M}_w P(\theta)} + 2A_2C \quad (2.28)$$

Fig. 2.7 Zimm plot of light-scattering data of polymer [2]

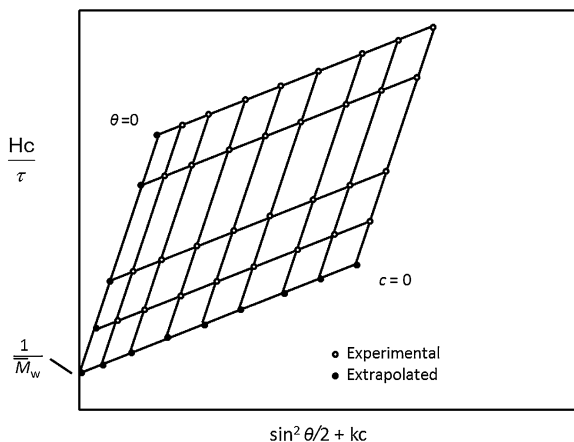

where $P(\theta)$ is a function of the angle, θ , at which τ is measured, a function that depends on the shape of the molecules in solution. A_2 is the second virial coefficient. Turbidity is then measured at different concentrations as well as at different angles, the latter to compensate for variations in molecular shape. The experimental data are then extrapolated to both zero concentration and zero angle, where $P(\theta)$ is equal to 1. Such double extrapolations, shown in Fig. 2.7, are called *Zimm plots*. The factor k on the abscissa is an arbitrary constant. The intercept corresponds to $1/\bar{M}_w$.

A major problem in light scattering is to obtain perfectly clear, dust-free solutions. This is usually accomplished by ultra centrifugation or careful filtration. Despite such difficulties, the light-scattering method is widely used for obtaining weight average molecular weights between 10,000 and 10,000,000. A schematic of a laser light-scattering photometer is given in Fig. 2.8.

Intrinsic viscosity is the most useful of the various viscosity designations because it can be related to molecular weight by the Mark-Houwink-Sakurada equation:

$$[\eta] = K\bar{M}_v^a \quad (2.29)$$

where \bar{M}_v , is the *viscosity average molecular weight*, defined as

$$\bar{M}_v = \left(\frac{\sum N_i M_i^{1+a}}{\sum N_i M_i} \right)^{1/a} \quad (2.30)$$

Log K and a are the intercept and slope, respectively, of a plot of $\log [\eta]$ versus $\log \bar{M}_w$ or $\log \bar{M}_n$ of a series of fractionated polymer samples. Such plots are linear (except at low molecular weights) for linear polymers, thus

$$\log[\eta] = \log K + a \log \bar{M} \quad (2.31)$$

Fig. 2.8 Schematic of a laser light scattering photometer [2]

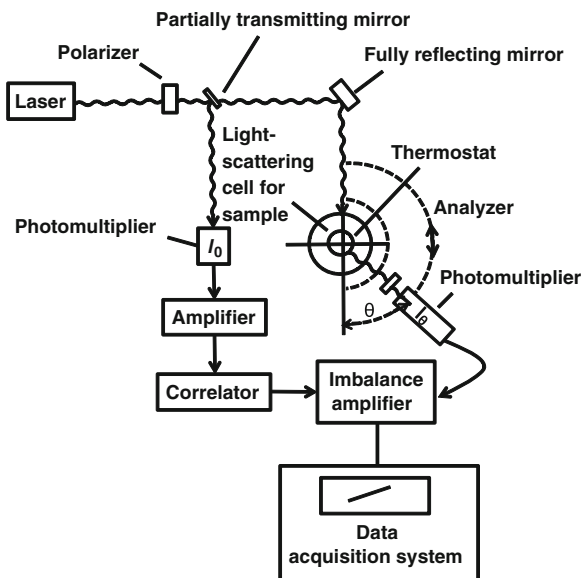
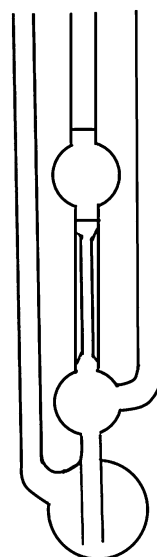

Fig. 2.9 A modified Ubbelohde viscometer with improved dilution characteristics



Factors that may complicate the application of the Mark-Houwink-Sakurada relationship are chain branching, too broad of molecular weight distribution in the samples used to determine K and a , solvation of polymer molecules, and the presence of alternating or block sequences in the polymer backbone. Chain entanglement is not usually a problem at high dilution except for extremely high molecular weights polymer. Ubbelohde type viscometer is more convenient to use

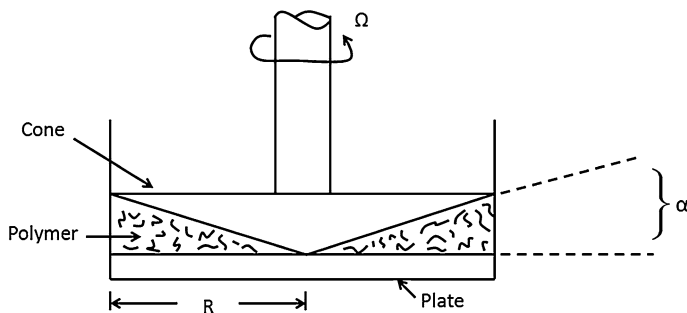

Fig. 2.10 Schematic of cone-plate rotational viscometer [2]

for the measurement of polymer viscosity, because it is not necessary to have exact volumes of solution to obtain reproducible results. Furthermore, additional solvent can be added (assuming the reservoir is large enough); thus concentration can be reduced without having to empty and refill the viscometer. A schematic of the Ubbelohde type viscometer is given in Fig. 2.9.

The viscosity of polymer can also be measured by the cone-plate rotational viscometer as shown in Fig. 2.10. The molten polymer or polymer solution is contained between the bottom plate and the cone, which is rotated at a constant velocity (Ω). Shear stress (τ) is defined as

$$\tau = \frac{3M}{2\pi R^3} \quad (2.32)$$

where M is the torque in dynes per centimeter (CGS) or in newtons per meter (SI), and R is the cone radius in centimeters. Shear rate ($\dot{\gamma}$) is given by

$$\dot{\gamma} = \frac{\Omega}{\alpha} \quad (2.33)$$

where Ω is the angular velocity in degrees per second (CGS) or in radians per second (SI) and α is the cone angle in degrees or radians. Viscosity is then

$$\eta = \frac{\tau}{\dot{\gamma}} = \frac{3\alpha M}{2\pi R^3 \Omega} = \frac{kM}{\Omega} \quad (2.34)$$

where k is

$$k = \frac{3\alpha}{2\pi R^3} \quad (2.35)$$

Gel permeation chromatography (GPC) involves the permeation of a polymer solution through a column packed with microporous beads of cross-linked polystyrene. The column is packed from beads of different sized pore diameters, as shown in Fig. 2.11. The large size molecules go through the column faster than the small size molecule. Therefore, the largest molecules will be detected first. The

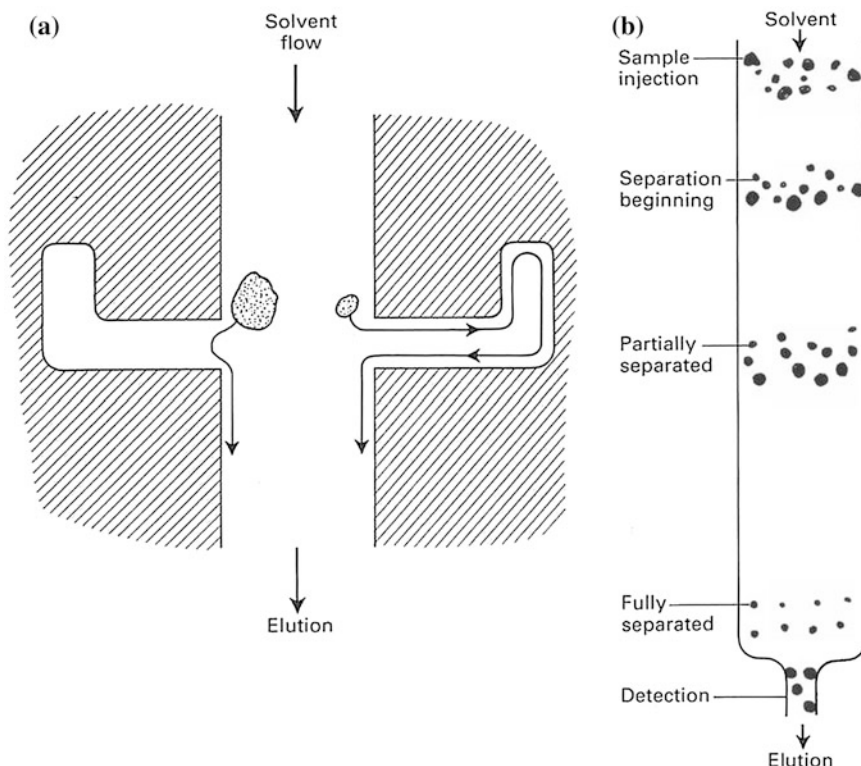

Fig. 2.11 Simple illustrations of the principle of gel permeation chromatography (GPC) [9]. (Adapted from I.M. Campbell, *Introduction to Synthetic Polymers*, Oxford, 1994, p. 26 with permission)

smallest size molecules will be detected last. From the elution time of different size molecule, the molecular weight of the polymer can be calculated through the calibration curves obtained from polystyrene standard.

For example, the synthesis of diblock copolymer: poly(styrene)-*b*-poly(2-vinylpyridine) (PS-*b*-P2VP) can be monitored by the GPC. Styrene is initiated by *sec*-butyl lithium first and then the polystyrene anion formed until the styrene monomer is completely consumed. Followed by introducing the 2-vinyl pyridine, a PS-*b*-P2VP block copolymer is finally prepared (Fig. 2.12). As shown in Fig. 2.13, the GPC results show that the PS anion was prepared first with low PDI (1.08). After adding the 2-VP, the PS-*b*-P2VP block copolymer was analyzed by GPC again, the PDI remained low, but the molecular weight has been doubled. More detailed discussions of anionic polymerizations will be present in Chap. 8.

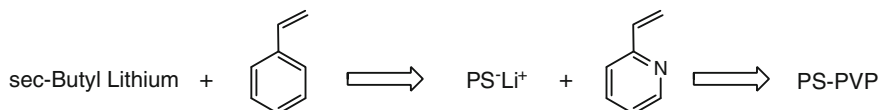
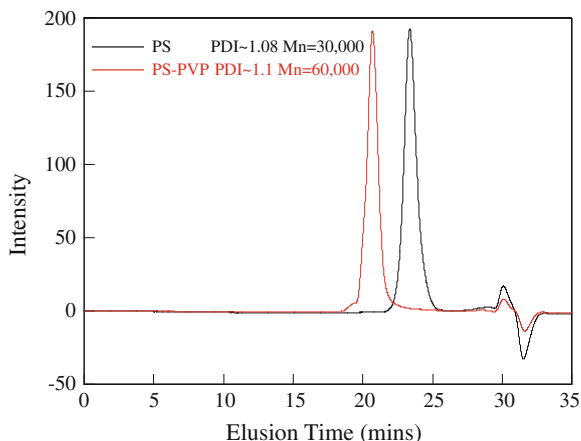

Fig. 2.12 Synthesis of PS-b-P2VP via anionic polymerization

Fig. 2.13 GPC traces of PS homo polymer and PS-b-P2VP block copolymer. The *right* peak is PS. The peak of copolymer is shifted to the *left* due to the addition of P2VP



2.4 Problems

1. A “model” of a linear polyethylene having a molecular weight of about 200,000 is being made by using a paper clip to represent one repeating unit. How many paper clips does one need to string together?
2. In general, the viscosity of polymer is reduced by increasing temperature. How might the magnitude of this effect compare for the polymer in a “poor” solvent or in a “good” solvent? (This is the basis for all weather multi viscosity motor oils.)
3. From the practical standpoint, is it better to use a “good” solvent or a “poor” solvent when measuring polymer molecular weight? Explain.
4. Discuss the value of knowledge of the molecular weight and distribution of a polymer to the polymer scientist and engineer. Which method would you use to obtain this information on a routine basis in the laboratory and in the production respectively? Why? Which method would you use to obtain this information for a new polymer type which is not previously known? Why?
5. What would be the number average, weight average molecular weight and polydispersity of a sample of polypropylene that consists of 5 mol of 1000 unit propylene and 10 mol of 10,000 unit propylene?
6. A 0.5000-g sample of an unsaturated polyester resin was reacted with excess acetic anhydride. Titration of the reaction mixture with 0.0102 M KOH required 8.17 mL to reach the end point. What is the number average

Elution time (min.)	Intensity
13.0	0.5
13.5	6.0
14.0	25.7
14.5	44.5
15.0	42.5
15.5	25.6
16.0	8.9
16.5	2.2

molecular weight of the polyester? Would this method be suitable for determining any polyester? Explain.

- Explain how one might experimentally determine the Mark-Houwink-Sakurada constants K and a for a given polymer. Under what conditions can you use $[\eta]$ to measure $\bar{r}_0^2 \bar{M}^{-1}$? How can $\bar{r}_0^2 \bar{M}^{-1}$ be used to measure chain branching?
- The molecular weight of poly(methyl methacrylate) was measured by gel permeation chromatography in tetrahydrofuran at 25°C and obtained the above data:
The polystyrene standard (PDI ~ 1.0) under the same conditions gave a linear calibration curve with $M = 98,000$ eluting at 13.0 min. and $M = 1,800$ eluting at 16.5 min.
 - Calculate \bar{M}_w and \bar{M}_n using the polystyrene calibration curve.
 - If the PDI of polystyrene is larger than 1.0, what errors you will see in the \bar{M}_n and \bar{M}_w of poly(methyl methacrylate).
 - Derive the equation that defines the type of molecular weight obtained in the “universal” calibration method in gel permeation chromatography.
- Please explain why the gel permeation chromatography method can measure both \bar{M}_n and \bar{M}_w , but the osmotic pressure method can only measure the \bar{M}_n and the light scattering method can only measure \bar{M}_w .
- Please calculate the end-to-end distance of a polymer with molecular weight of 1 million and intrinsic viscosity of 2.10 dl/g and assume $\Phi = 2.1 \times 10^{21}$. What is the solution behavior of this polymer? [10]

References

- G. Odian, *Principle of Polymerization*, 4th edn. (Wiley Interscience, New York, 2004)
- M.P. Stevens, *Polymer Chemistry*, 3rd edn. (Oxford, New York, 1999)
- P.A. Small, *J. Appl. Chem.* **3**, 71–80 (1953)

4. K.L. Hoy, *J. Paint Tech.* **42**, 76–118 (1970)
5. J. Brandrup, E.H. Immergut (eds.), *Polymer Handbook*, 3rd edn. (Wiley, New York, 1989)
6. A.F.M. von Barton, *CRC Handbook of Polymer-Liquid Interaction Parameters and Solubility Parameters* (CRC Press, Boca Raton, 1990)
7. P.J. Flory, *Principles of Polymer Chemistry*. (Cornell University, Ithaca, 1953)
8. F.W. Billmeyer, Jr., *Textbook of Polymer Science*, 3rd edn. (Wiley, New York, 1984)
9. I.M. Campbell, *Introduction to Synthetic Polymers*. (Oxford University Press, Oxford, 1994)
10. K.A. Peterson, M.B. Zimmt, S. Linse, R.P. Domingue, M.D. Fayer, *Macromolecules* **20**, 168–175 (1987)