

A New Modular Marx Derived Multilevel Converter

Luis Encarnação¹, José Fernando Silva², Sónia F. Pinto², and Luis. M. Redondo¹

¹Instituto Superior de Engenharia de Lisboa, Cie3, Portugal
luisrocha@deea.isel.pt, lmredondo@deea.isel.pt

²Instituto Superior Técnico, Cie3, TU Lisbon, Portugal
fernandos@alfa.ist.utl.pt, soniafp@ist.utl.pt

Abstract. A new Modular Marx Multilevel Converter, M^3C , is presented. The M^3C topology was developed based on the Marx Generator concept and can contribute to technological innovation for sustainability by enabling wind energy off-shore modular multilevel power switching converters with an arbitrary number of levels. This paper solves both the DC capacitor voltage balancing problem and modularity problems of multilevel converters, using a modified cell of a solid-state Marx modulator, previously developed by authors for high voltage pulsed power applications. The paper details the structure and operation of the M^3C modules, and their assembling to obtain multilevel converters. Sliding mode control is applied to a M^3C leg and the vector leading to automatic capacitor voltage equalization is chosen. Simulation results are presented to show the effectiveness of the proposed M^3C topology.

Keywords: Modular Multilevel, Capacitor voltage equalization, Marx modulator.

1 Introduction

Multilevel converters (MC) are the technology of choice for medium and high voltage flexible AC transmission systems (FACTS). Their industrial use is increasing in FACTS, as MCs enable the use of existing power semiconductors with nearly 5kV blocking capability to obtain converters able to operate at 100-300 kV. MCs are being preferred over conventional two-level converters, as the required high number of levels of their staircase output voltages additionally reduces total harmonic distortion (THD) and electromagnetic interference (EMI)[1].

However, well known MC topologies such as the Neutral-Point Clamped (NPC), flying capacitor (FC), and cascaded H-bridge (CHB), have strong limitations in balancing the DC capacitor voltage dividers that limit the semiconductor voltages to a few kV, when the required number of level increases beyond five. Some topologies such as NPC and FC are also not modular and their complexity increases with the square of the number of the levels required.

To solve these problems, half bridge based modular approaches (M^2LC) were proposed in 2001 [2]. However, the half bridge concept needs redundancy and must

sample all the capacitor voltages for the central processor to decide which power semiconductors should be switched on or off [3, 4, 5].

This paper solves the modularity problems of MCs and the DC capacitor voltage balancing, using a modified cell of the solid state Marx modulator, previously developed by authors for high voltage pulsed power applications [6]. The DC capacitor voltage measuring circuits and control complexity are completely avoided since the modified cell, called Modular Marx MC (M^3C), performs DC capacitor voltage balancing automatically, using just an extra switch without needing no DC capacitor voltage measurements.

After the Contribution to Sustainability (section 2), the paper details the structure and operation of M^3C modules and the assembling of basic cells to obtain MCs. Three and five-level M^3C topologies are presented (section 3), detailing the capacitor balancing in the three-level topology. Simulation results are presented in Section 4 to show the effectiveness of the proposed sliding mode controlled M^3C 5 level topology for two selected applications.

2 Contribution to Sustainability

In the emerging area of modular MCs, this paper proposes a new modular semiconductor cell, M^3C , to build high voltage high number of levels MCs for FACTS or DC-AC converters for off-shore wind parks. The Marx derived M^3C cell solves two main problems in MCs: 1) All M^3C cells are identical (modularity) and 2) they provide inherent balancing capability of all DC capacitor voltages avoiding voltage measuring circuits and regulation costs. Power Converters using M^3C cells will contribute to energy availability, regulation and cleanliness, enhancing energy sustainability.

3 Modular Multilevel Marx Converter M^3C

The M^3C modules and their assembling to obtain MCs are described. Circuit configurations for three-level and a five-level inverter legs are presented.

3.1 M^3C Cell and Three-Level MC Leg

The M^3C cell topology adds an extra switch, S_{EK} , (Fig. 1a), to each Marx basic cell [6], providing a bi-directional switch with the existing diode D_{EK} . Therefore, the charge of C_K capacitors in adjacent cells (Fig. 1b) can be equalized turning on switch pairs S_K, D_K and S_{EK}, D_{EK} .

The three-level MC leg topology uses two basic cells (Fig. 1b) for each half arm, with a total of 4 cells.

From (Fig. 1b), considering voltages $U_{CA} \approx U_{CB}$ and $U_{dc} = U_{CA} + U_{CB}$, each capacitor will be charged with voltage $U_{Ci} = U_{dc}/(n-1)$, where n represents the number of levels (in this case $n=3$, implying $U_{Ci} = U_{dc}/2$).

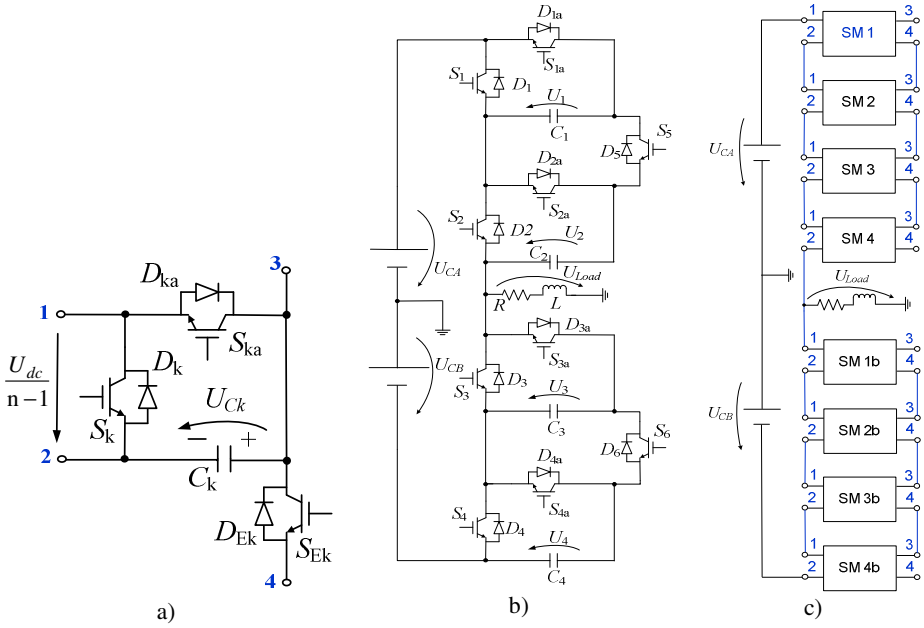

Fig. 1. Modular Multilevel Marx Converter topology: a) Structure of the basic cell; b) Three-Level M³C leg; c) Five-Level M³C leg using 8 cells

To understand the operating principles of three-level Modular Multilevel Marx Converter (Fig. 1b), Table 1 shows the three voltage levels of voltage U_{Load} and the number of turned on (S_K on) basic cells which are necessary to obtain those voltage levels (or voltage vectors) on each arm. Also, the number of possible redundant states for each level (vector) is shown.

Table 1. Voltage levels and number of vectors for a Three-Level M³C leg

Vector	U_{Load}	Number of ON Cells		Number of States = n possibilities upper Arm × n possibilities bottom Arm
		Upper	Bottom	
1	$-U_{dc}/2$	0	2	$1 \times 1 = 1$
2	0	1	1	$2 \times 2 = 4$
3	$+U_{dc}/2$	2	0	$1 \times 1 = 1$

3.2 Five-Level M³C Leg

Using the basic M³C cell, n level MCs can be obtained, using n-1 basic cells for the upper arm, and n-1 cells for the bottom arm. Therefore, to obtain a five-level M³C eight basic cells are necessary for each converter arm (Fig. 1c). There are several redundant states in levels 2, 3, 4, depending on the state of each cell (Table 2).

Table 2. Voltage levels and number of vectors for a Five-Level M³C leg

Vector	U_{Load}	Number of ON Cells		Number of States
		Upper	Bottom	
1	$-U_{dc}/2$	0	4	$1 \times 1 = \mathbf{1}$
2	$-U_{dc}/4$	1	3	$4 \times 4 = \mathbf{16}$
3	0	2	2	$6 \times 6 = \mathbf{36}$
4	$+U_{dc}/4$	3	1	$4 \times 4 = \mathbf{16}$
5	$+U_{dc}/2$	4	0	$1 \times 1 = \mathbf{1}$

3.3 DC Capacitor Voltage Balancing

To illustrate the cell inherent balancing capability, consider for example, a three level leg with the two upper cells conducting (S_1 and S_2 on) to obtain $U_{Load} = U_{dc}/2$. Then the conduction of the extra switch (S_5 or D_5) parallels the two upper capacitors (C_1, C_2) equaling their charges. The equivalent happens in the bottom arm, with capacitors C_3 and C_4 , when applying the vector 1 to obtain the minimum level ($U_{Load} = -U_{dc}/2$).

Table 3 lists the switch states for all the operating vectors including the 4 possible states of vector 2 ($U_{Load} = 0V$). It is easy to see that the state V2a, in which S_{1A}, S_2 and S_5 conduct in the upper arm, also connects capacitors C_1 and C_2 in parallel equalizing their charge. Therefore this state should be the only one to be used for vector 2. Fig. 2 confirms the above reasoning by presenting our simulation results ($U_{dc}=2000V, C_1=C_2=C_3=C_4=10\mu F$ and inductive load RL 1mH, 50Ω), each simulation using one state of vector 2. It is shown that using state V2a the capacitor voltages are balanced (Fig. 2a), while for remaining states (Fig. 2b, Fig. 2c and Fig. 2d), the capacitor voltages are unbalanced.

Table 3. States of semiconductors (1 if ON, 0 if OFF) for a Three-Level M³C leg

Level	State	S1	S1a	S2	S2a	S5	S3	S3a	S4	S4a	S6	U_{LOAD}
1	V1	0	1	0	1	0	1	0	1	0	1	$-U_{CB}$
2	V2a	0	1	1	0	1	0	1	1	0	1	0V
	V2b	1	0	0	1	0	1	0	0	1	0	
	V2c	0	1	1	0	1	1	0	0	1	0	
	V2d	1	0	0	1	0	0	1	1	0	1	
3	V3	1	0	1	0	1	0	1	0	1	0	U_{CA}
Upper Arm						Bottom Arm						

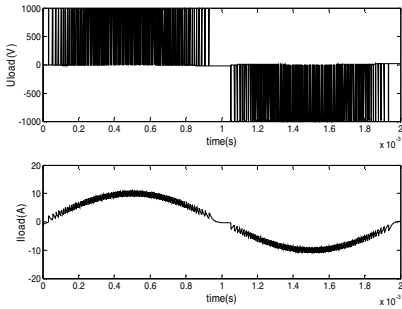

2a) Vector 2a

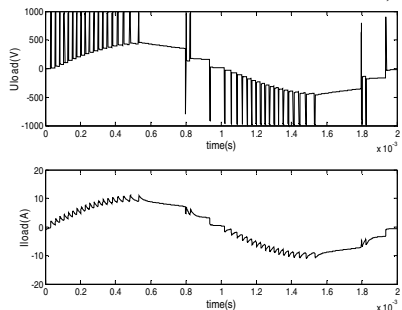
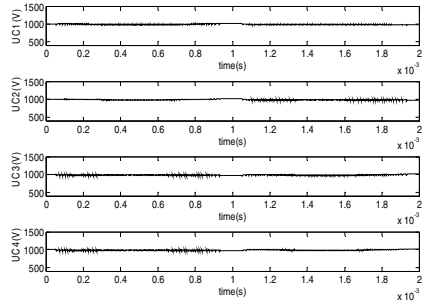

2b) Vector 2b

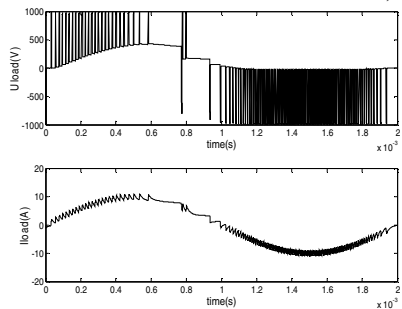
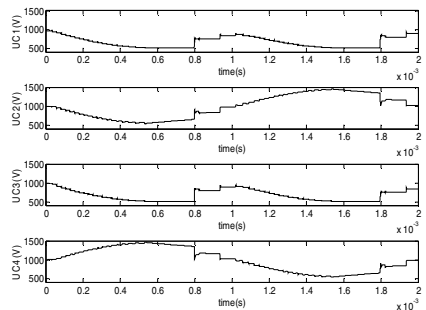

2c) Vector 2c

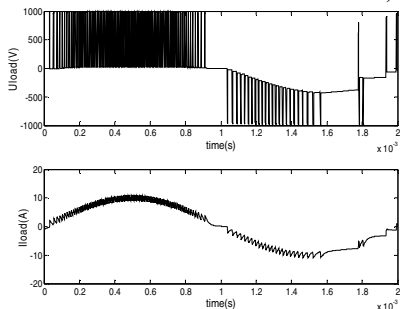
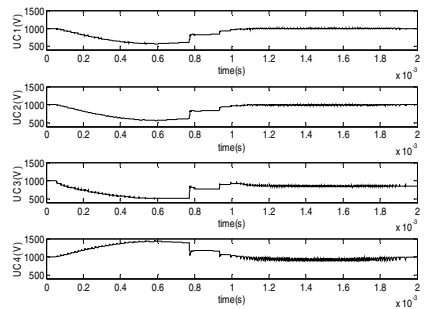

2d) Vector 2d

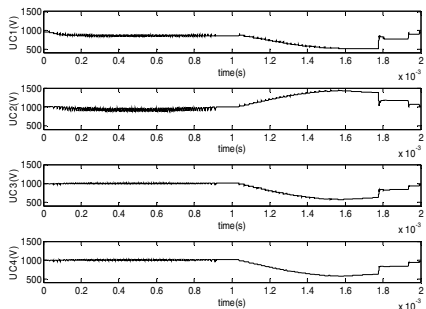

Voltage load 3level ($\pm U_{dc}/2$; 0V)
and Current load (Sinusoidal)

Voltages of capacitors ($U_1 U_2 U_3 U_4$)

Fig. 2. Simulation results for the three-level arm obtained with vectors V2a, V2b V2c and V2d

4 Sliding Mode Controlled Five-Level M³C Leg

Two applications of five-level M³C are simulated in the Matlab/Simulink environment using a sliding-mode stability based multilevel modulator [7, 8, 9], according to Fig. 3 [7]. Circuit parameters are $U_{dc}=2000V$, $C_K =5\mu F$, $K_i=1000$ and capacitive load RLIC (1MΩ, 100nF) in series with L=1nH.

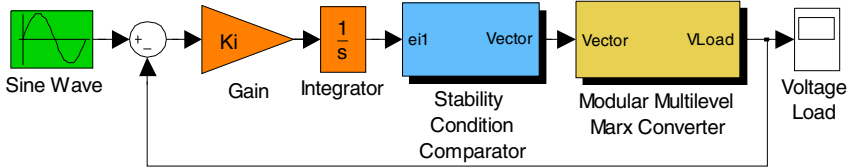

Fig. 3. Block diagram of the sliding-mode stability based multilevel modulator for M³C

The first application illustrates the M³C operating as a high voltage pulse generator (Marx Generator). The M³C was designed for five positive levels (0V; $\frac{1}{4} U_{dc}$; $\frac{1}{2} U_{dc}$; $\frac{3}{4} U_{dc}$; U_{dc}). The amplitude of the impulse reference is 1350V. Sliding mode control is suitable to overcome the slow C_K capacitors discharge, usually called “voltage droop”. The sliding-mode stability based modulator ensures the desired voltage applied to the load by increasing or decreasing the chosen level (Fig. 4a) so that the mean value of the error of the controlled output voltage is near zero inside a tolerance band of $\pm 6mV$ (Fig. 4b). The M³C controller uses the third ($\frac{1}{2} U_{dc}=1000V$) and the fourth level ($\frac{3}{4} U_{dc} =1500V$) to maintain the desired output average value near $U=1350V$.

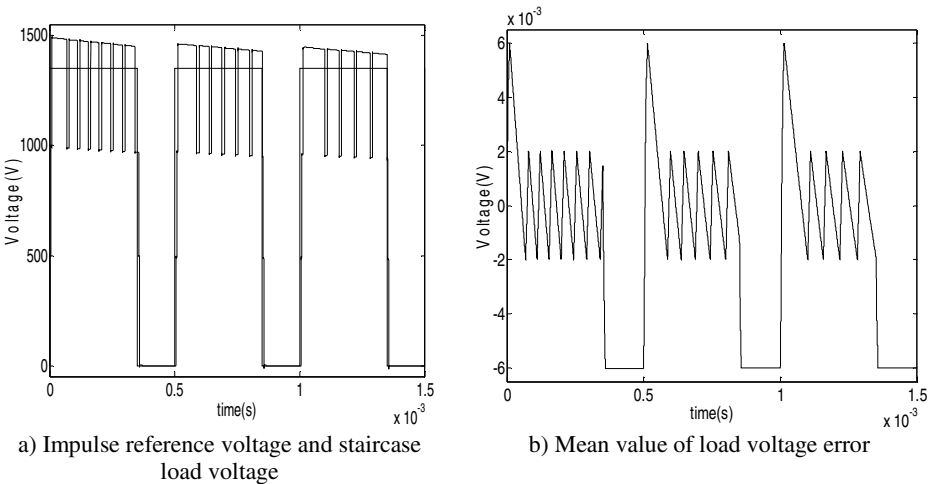
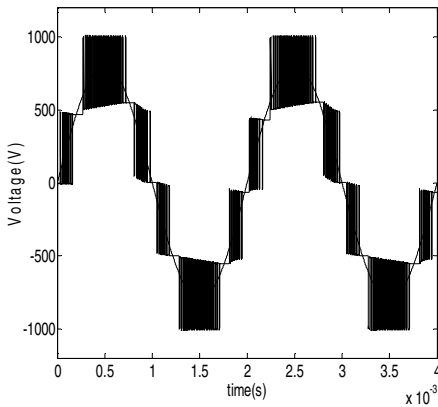
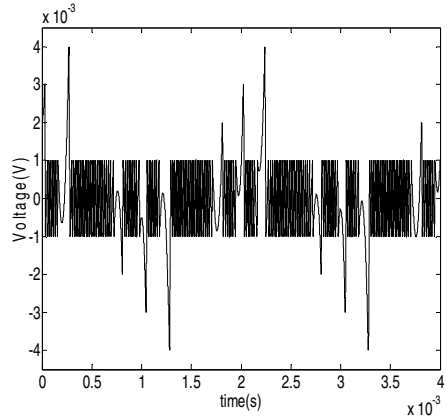

Fig. 4. Simulation results for M³C operating as a Marx Generator



a) Sinusoidal reference voltage and staircase load voltage



b) Mean value of load voltage error

Fig. 5. Simulation results for M³C operating as a five level inverter

In the second application, the 5 level M³C operates as a multilevel inverter to deliver a sinusoidal output voltage with reference amplitude equal to 800V (Fig. 5a). In this case, the output voltage levels used are $\pm 1/2 U_{dc}$, $\pm 1/4 U_{dc}$, 0V). Fig. 5b presents the mean value of the error of the controlled output voltage showing it is nearly zero (± 4 mV tolerance).

Fig. 6 shows the 8 capacitor voltages obtained in this operation. The capacitor voltages are balanced within approximately $\pm 10\%$ of their working voltage.

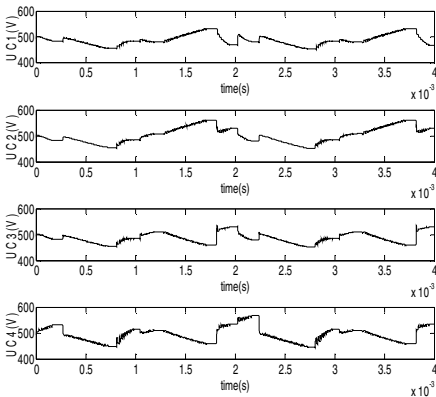

6a) Upper Arm ($U_1 U_2 U_3 U_4$)

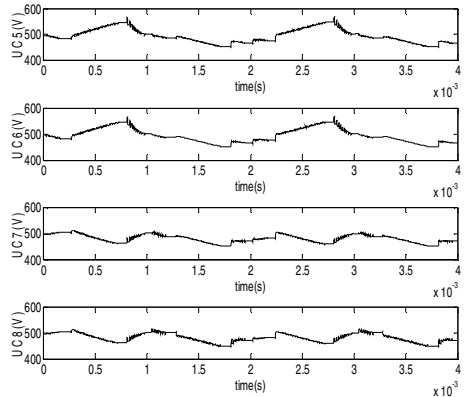

6b) Bottom Arm ($U_5 U_6 U_7 U_8$)

Fig. 6. Simulation results showing balanced capacitor voltages in M³C inverter operation

5 Conclusions

This paper presented a new Modular Multilevel Marx Converter, M^3C , using modules based on the Marx Generator concept. The addition of one on-off controlled semiconductor switch enabled the parallel connection of capacitors, therefore equalizing their charge.

The M^3C concept uses one more controlled semiconductor per cell, but the absence of this extra switch makes the dc voltage balancing possible only in some cases by measuring capacitor voltages and using redundant states, or different cell capacitance values, which makes existing MC cells non-modular.

The M^3C cells are modular in design, being suited to build multilevel converters with several tens of levels. They allow a high number of redundant states, which can also be used for capacitor voltage balancing without the need to measure the capacitor voltages or extra balancing algorithms. The drawback of using one extra semiconductor per cell is justifiable by the absence of measurement and control circuits associated with the balancing of capacitor voltages.

To illustrate the M^3C operation, as a Marx-generator and as a 5 level inverter, sliding-mode stability based multilevel modulators were applied to a 5 level M^3C leg. The sliding-mode stability modulator selected the appropriate levels to synthesize the desired output voltage waveforms. Simulation results showed the needed waveforms and the correct balancing of the dc capacitor voltage waveforms.

References

1. Franquelo, L.G., Rodríguez, J., Leon, J.I., Kouro, S.: The age of multilevel converters arrives. *IEEE Industrial Electronics Magazine* 2(2), 28–39 (2008)
2. Lesnicar, M.R.: An Innovative Modular Multilevel Converter Topology Suitable for a Wide Power Range. In: *IEEE Power Tech. Conference*, Bologna, Italy (2003)
3. Hagiwara, M., Akagi, H.: PWM Control and Experiment of Modular Multilevel Converters. In: *IEEE Power Electronic Specialist Conference*, Rhodes, pp. 154–161 (2008)
4. Adam, G.P., Anaya-Lara, O.G., Burt, M.J.: Comparison between Two VSC-HVDC Transmission Systems Technologies: modular and Neutral Point Clamped Multilevel Converter. In: *35th Annual Conference of the IEEE Industrial Electronics Society – IECON Porto, Portugal* (2009)
5. Adam, G.P., Anaya-Lara, O.G., Finney, S.J., Williams, B.W.: Comparison between flying capacitor and modular multilevel inverters. In: *35th Annual Conference of the IEEE Industrial Electronics Society – IECON Porto, Portugal* (2009)
6. Redondo, L.M., Fernando, S.J.: Repetitive High-Voltage Solid-State Marx Modulator Design for Various Load Conditions. *IEEE Transactions on Plasma Science* 37(8), 1632–1637 (2009)
7. Silva, J., Fernando, P.S.F.: Control Methods for Switching Power Converters. cap. 34. In: Rashid, M.H. (ed.) *Power Electronics Handbook*, 2nd edn., USA, pp. 935–998, p. 1172. Academic Press, Elsevier (2007)
8. Encarnação, L., Silva, J.F.: Sliding Condition Based Sliding Mode Modulators for Multilevel Power Converters. In: *35th Annual Conference of the IEEE Industrial Electronics Society – IECON Porto, Portugal* (2009)
9. Encarnação, L., Silva, J.F.: Reactive Power Compensation Using Sliding-Mode Controlled Three-Phase Multilevel Converters. In: *12th International Conference on Harmonics and Quality of Power – ICHQP Cascais, Portugal* (2006)