



Lecture Notes in Mechanical Engineering

Holger Kohl  
Günther Seliger  
Franz Dietrich *Editors*

# Manufacturing Driving Circular Economy

Proceedings of the 18th Global  
Conference on Sustainable  
Manufacturing, October 5–7, 2022,  
Berlin


OPEN ACCESS

 Springer

# Lecture Notes in Mechanical Engineering


## Series Editors

Fakher Chaari, *National School of Engineers, University of Sfax, Sfax, Tunisia*

Francesco Gherardini , *Dipartimento di Ingegneria “Enzo Ferrari”, Università di Modena e Reggio Emilia, Modena, Italy*

Vitalii Ivanov, *Department of Manufacturing Engineering, Machines and Tools, Sumy State University, Sumy, Ukraine*

## Editorial Board Members

Francisco Cavas-Martínez , *Departamento de Estructuras, Construcción y Expresión Gráfica Universidad Politécnica de Cartagena, Cartagena, Murcia, Spain*

Francesca di Mare, *Institute of Energy Technology, Ruhr-Universität Bochum, Bochum, Nordrhein-Westfalen, Germany*

Mohamed Haddar, *National School of Engineers of Sfax (ENIS), Sfax, Tunisia*

Young W. Kwon, *Department of Manufacturing Engineering and Aerospace Engineering, Graduate School of Engineering and Applied Science, Monterey, CA, USA*

Justyna Trojanowska, *Poznan University of Technology, Poznan, Poland*

Jinyang Xu, *School of Mechanical Engineering, Shanghai Jiao Tong University, Shanghai, China*

**Lecture Notes in Mechanical Engineering (LNME)** publishes the latest developments in Mechanical Engineering—quickly, informally and with high quality. Original research reported in proceedings and post-proceedings represents the core of LNME. Volumes published in LNME embrace all aspects, subfields and new challenges of mechanical engineering.

To submit a proposal or request further information, please contact the Springer Editor of your location:

**Europe, USA, Africa:** Leontina Di Cecco at [Leontina.dicecco@springer.com](mailto:Leontina.dicecco@springer.com)

**China:** Ella Zhang at [ella.zhang@springer.com](mailto:ella.zhang@springer.com)

**India:** Priya Vyas at [priya.vyas@springer.com](mailto:priya.vyas@springer.com)

**Rest of Asia, Australia, New Zealand:** Swati Meherishi at [swati.meherishi@springer.com](mailto:swati.meherishi@springer.com)

Topics in the series include:

- Engineering Design
- Machinery and Machine Elements
- Automotive Engineering
- Engine Technology
- Aerospace Technology and Astronautics
- Nanotechnology and Microengineering
- MEMS
- Theoretical and Applied Mechanics
- Dynamical Systems, Control
- Fluid Mechanics
- Engineering Thermodynamics, Heat and Mass Transfer
- Manufacturing
- Precision Engineering, Instrumentation, Measurement
- Tribology and Surface Technology

**Indexed by SCOPUS and EI Compendex.**

All books published in the series are submitted for consideration in Web of Science.

To submit a proposal for a monograph, please check our Springer Tracts in Mechanical Engineering at <https://link.springer.com/bookseries/11693>

Holger Kohl · Günther Seliger · Franz Dietrich  
Editors

# Manufacturing Driving Circular Economy

Proceedings of the 18th Global Conference on  
Sustainable Manufacturing, October 5–7, 2022,  
Berlin

*Editors*

Holger Kohl  
Technical University of Berlin  
Berlin, Germany

Günther Seliger  
Technical University of Berlin  
Berlin, Germany

Franz Dietrich  
Technical University of Berlin  
Berlin, Germany



ISSN 2195-4356

ISSN 2195-4364 (electronic)

Lecture Notes in Mechanical Engineering

ISBN 978-3-031-28838-8

ISBN 978-3-031-28839-5 (eBook)

<https://doi.org/10.1007/978-3-031-28839-5>

© The Editor(s) (if applicable) and The Author(s) 2023, corrected publication 2023. This book is an open access publication.

**Open Access** This book is licensed under the terms of the Creative Commons Attribution 4.0 International License (<http://creativecommons.org/licenses/by/4.0/>), which permits use, sharing, adaptation, distribution and reproduction in any medium or format, as long as you give appropriate credit to the original author(s) and the source, provide a link to the Creative Commons license and indicate if changes were made.

The images or other third party material in this book are included in the book's Creative Commons license, unless indicated otherwise in a credit line to the material. If material is not included in the book's Creative Commons license and your intended use is not permitted by statutory regulation or exceeds the permitted use, you will need to obtain permission directly from the copyright holder.

The use of general descriptive names, registered names, trademarks, service marks, etc. in this publication does not imply, even in the absence of a specific statement, that such names are exempt from the relevant protective laws and regulations and therefore free for general use.

The publisher, the authors, and the editors are safe to assume that the advice and information in this book are believed to be true and accurate at the date of publication. Neither the publisher nor the authors or the editors give a warranty, expressed or implied, with respect to the material contained herein or for any errors or omissions that may have been made. The publisher remains neutral with regard to jurisdictional claims in published maps and institutional affiliations.

This Springer imprint is published by the registered company Springer Nature Switzerland AG  
The registered company address is: Gewerbestrasse 11, 6330 Cham, Switzerland

# Preface

We are pleased to publish a collection of papers presented at the 18th Global Conference on Sustainable Manufacturing (GCSM), held on October 5–7, 2022, in Berlin, Germany. The conference is annually sponsored by the International Academy for Production Engineering (CIRP), committed to excellence in the creation of sustainable products and processes. GCSM 2022 was jointly organized by the Institut für Werkzeugmaschinen und Fabrikbetrieb (IWF/TU Berlin) and Fraunhofer Institut für Produktionsanlagen und Konstruktionstechnik (IPK).

The GCSM 2022 brought together more than 149 attendees from 25 countries providing a global forum of academics, researchers, and specialists from universities, research institutes, and industry from across the globe, working on topics related to sustainable manufacturing. A unique feature of the GCSM conference series is its integration of industrial engineering perspectives, sustainable manufacturing applications in emerging and developing countries, as well as education and workforce development for advancing sustainable manufacturing. Plenary keynote speeches by experienced personalities from academics and industry, paper sessions presentations, and workshops of student teams from different countries offered new insights and chances for exchange of ideas. The conference featured twelve keynote speakers who shared recent advances in cutting-edge research and industry practices; these prominent and internationally recognized experts elaborated how technologies in the product, process, and system domains can enable sustainable manufacturing.

This volume documents more than 120 contributions presented at GCSM 2022 in 22 sessions held over three days. The proceedings are organized according to the conference program classified into four broad categories as: Sustainable Processes, Sustainable Manufacturing Systems, Sustainable Manufacturing Products, and Crosscutting Topics in Sustainable Manufacturing. The papers cover a variety of topics in these areas related to modeling and simulation of manufacturing processes, product design for sustainability, metrics for sustainability assessment, energy efficiency in manufacturing, strategies and business models, as well as education and workforce development for sustainable manufacturing. All papers published in these proceedings have been reviewed by experts from the international scientific committee.

In addition to keynotes and paper sessions, a session on student projects was included in the GCSM 2022 program to further its mission, by involving the younger on the challenges of sustainable manufacturing. Students from different countries exchanged their perspectives on how to tackle the “Sustainable Development Goals” of the United Nations, by presenting and discussing concrete projects.

Holger Kohl  
Franz Dietrich  
Günther Seliger

# Organization

## Organizing Committee

Holger Kohl	International Chairman
Franz Dietrich	Local Chairman
Günther Seliger	Founding Chairman
Ömer Şahin Ganiyusufoğlu	Organizational Team
Ana Paula Barquet	Organizational Team
Wolf Schliephack	Organizational Team
Nwaoyibo Donatus Junior	Organizational Team

## International Scientific Committee

Ahmed Abu Hanieh	Birzeit University, Turkey
Tülin Aktin	Istanbul Kültür Üniversitesi, Turkey
Dirk Bähre	Universität des Saarlandes, Germany
Peter Ball	University of York, Great Britain
Milton Borsato	Universidade Tecnológica Federal do Paraná
Erhan Budak	Sabancı Üniversitesi, Turkey
Giampaolo Campana	Università di Bologna, Italy
Barbara Cimatti	Università di Bologna, Italy
Pedro Filipe Cunha	Escola Superior de Tecnologia de Setubal, Brazil
Franz Dietrich	Technische Universität Berlin, Germany
Matthew Doolan	Australian National University, Australia
Mohamed El Mansori	Arts et Métiers ParisTech (ENSAM), France
Kleber F. Espôsto	Universidade de São Paulo, Brazil
Jürgen Fleischer	Karlsruhe Institut für Technologie, Germany
Ömer Şahin Ganiyusufoğlu	Shenyang Machine Tool Co., Ltd., China
Robert Gao	Case Western University, USA
Brian Gibson	Oak Ridge National Laboratory, USA
Wit Grzesik	Technical University of Opole, Poland
Thomas Guidat	Vietnamese German University, Vietnam
Karl Haapala	Oregon State University, USA
Ramsey Hamade	American University of Beirut, Lebanon
Christoph Herrmann	Technische Universität Braunschweig, Germany
Roland Jochem	Technische Universität Berlin, Germany
Holger Kohl	Technische Universität Berlin, Germany

Philip Koshy	McMaster University
Bert Lauwers	Katholieke Universiteit Leuven, Belgium
Terje Kristoffer Lien	Norges teknisk-naturvitenskapelige universitet, Norway
Sandra Naomi Morioka	Federal University of Paraíba, Brazil
Andrew Nee Yeh Ching	National University of Singapore, Singapore
Aldo Roberto Ometto	Universidade de São Paulo, Brazil
Jose Outeiro	École Nationale Supérieure d'Arts et Métiers, France
Emanuele Pagone	Cranfield University, Great Britain
Günther Seliger	Technische Universität Berlin, Germany
Semih Severengiz	Hochschule Bochum, Germany
Rainer Stark	Technische Universität Berlin, Germany
Frank Straube	Technische Universität Berlin, Germany
John W. Sutherland	Purdue University, USA
Shozo Takata	Waseda University, Japan
Eckart Uhlmann	Technische Universität Berlin, Germany
Dzuraidah Abdul Wahab	The National University of Malaysia, Malaysia
Lihui Wang	KTH Royal Institute of Technology, Sweden
Tetsuo Yamada	University of Electro-Communications, Japan
Hitomi Yamaguchi	University of Florida, USA
Chris Yuan	Case Western University, USA
Weimin Zhang	Tongji University, Shanghai, China
Fu Zhao	Purdue University, USA
Sudhir Yadav	Pandit Deendayal Petroleum University
Karel Kellens	KU Leuven, Belgium
Loice Gudukeya	University of Johannesburg, South Africa
Sina Peukert	Karlsruhe Institute of Technology, Germany
Mateus Gerolamo	University of São Paulo, Brazil
Welf-Guntram Drossel	Fraunhofer IWU, Chemnitz, Germany
Barbara Linke	University of California, Davis, USA
Yongrong Li	SKF Lubrication Systems Germany GmbH, Germany
Henning Strauß	FH Kiel, Germany
Stefan Hoyer	TU Chemnitz, Germany
Nicole Stricker	Aalen University, Germany
Wilfried Sihh	Technische Universität Vienna, Austria
Ong Soh Khim	National U of Singapore, Singapore
Ines Dani	Fraunhofer IWU, Chemnitz, Germany
Thomas Volling	Technische Universität Berlin, Germany
Michael Zaeh	Technical University of Munich, Germany
Jürgen Mallon	FH Kiel, Germany



Steffen Ihlenfeldt	Fraunhofer IWU, Chemnitz, Germany
Ana Paula Barquet	Technische Universität Berlin, Germany
Carsten Heinzl	Universität Bremen, Germany
Fazleena Badurdeen	University of Kentucky, Germany
Ezutah Olugu	UCSI University Kuala Lumpur, Malaysia
Shun Yang	Karlsruhe Institute of Technology, Germany
Rok Vrabič	University of Ljubljana, Slovenia
Sze Yin Kwok	Blekinge Institute of Technology
Vennan Sibanda	National University of Science and Technology
Sotiris Makris	LMS—University of Patras, Greece
Jörg Franke	FAU Erlangen, Germany
Jiahua Weng	Kanagawa University, Japan
Takayuki Kataoka	Kindai University, Japan
Junying Min	Tongji University, Shanghai, China
Anke Müller	Hof University, Germany
Buddhika Hapuwatte	University of Kentucky, USA
Ning He	Nanjing University of Aero. & Astro., China
Jan Schmitt	TH Würzburg-Schweinfurt, Germany
Elita Amrina	Universitas Andalas, Padang, Indonesia
H. P. Lee	National University of Singapore, Singapore
Ryosuke Nakajima	The University of Electro-Communications, Japan
Oliver Damm	Stellenbosch University, South Africa
Khaled Medini	Mines Saint-Etienne, France
Olasumbo Makinde	Tshwane University of Technology, South Africa
Ilesanmi Afolabi Daniyan	Tshwane University of Technology, South Africa
Tawanda Mushiri	University of Johannesburg, South Africa
Tim van Erp	University of Southern Denmark, Denmark
Matthias Schmidt	Leuphana Universitaet Lüneburg, Germany
Paul Refalo	University of Malta, Malta
Afif Aqel	Birzeit University
Vi Nguyen	Vietnamese-German University, Vietnam
Feri Afrinaldi	Universitas Andalas, Padang, Indonesia
Sebastian Müller	FAU Erlangen, Germany
Takashi Miyauchi	Toshiba, Japan
Philipp Bohr	Industria Fox, Brazil
Jing Li	Capital University of Economics and Business
Shuho Yamada	Toyama Prefectural University, Japan
David Sarancic	Technical University of Denmark, Denmark
Yuki Kinoshita	SECOM Co., Ltd., Japan

# Contents

## Manufacturing Processes

3D-Printed MWF Nozzles for Improved Energy Efficiency and Performance During Grinding .....	3
<i>Robert Zmich and Carsten Heinzl</i>	
Model-Based Correlation Analysis of Machine Control Parameters and Process Vibration Amplitudes by the Example of Milling .....	12
<i>Shu Ju, Max Reitenspieß, Kai Zhang, and Nico Hanenkamp</i>	
A Comparative Sustainability Assessment of Cutting Fluids Usage in Band Sawing .....	21
<i>Nithin Rangasamy, Roan Kirwin, and C. S. Rakurty</i>	
Design and Characterization of Piezoceramic Thick Film Sensor for Measuring Cutting Forces in Turning Processes .....	30
<i>M. Panesso, M. Ettrichrätz, S. Gebhardt, O. Georgi, C. Rüger, M. Gnauck, and W.-G. Drossel</i>	
The Costs of More Sustainable Castings Can we Afford the Change? .....	40
<i>Lucas Pelchen and Sebastian Müller</i>	

## Supply Chain and Remanufacturing

reProd® – Resource-Autarkic Production Based on Secondary Semi-finished Products .....	51
<i>Markus Werner, Rico Haase, and Christian Hermeling</i>	
Reducing Remanufacturing Uncertainties with the Digital Product Passport .....	60
<i>Viola Gallina, Barna Gal, Ádám Szaller, Daniel Bachlechner, Elisabeth Ilie-Zudor, and Wilfried Sihn</i>	
Digital Supply Chain Twins for Sustainable Planning of a Logistics System .....	68
<i>Simon Zarnitz, Frank Straube, and Benjamin Nitsche</i>	
Optimization of a Remanufacturing Production Planning System with the Help of Artificial Intelligence .....	77
<i>Barna Gal, Viola Gallina, Ádám Szaller, and Sebastian Schlund</i>	

Circular Supply Chain Management in the Wind Energy Industry – A Systematic Literature Review .....	85
<i>Kathrin Julia Kramer and Matthias Schmidt</i>	
Analysis of Elementary Technology Considering the Remanufacturing of Used Machinery: A Case Study .....	94
<i>Yongsung Jun and Yungchul Yoo</i>	
Measurement of Disassembly Work Using Optical Motion Capture .....	103
<i>Ryuto Kawane, Hiromasa Ijuin, Ryosuke Nakajima, Masao Sugi, Shuho Yamada, and Tetsuo Yamada</i>	
Simulation-Based Analysis of (Reverse) Supply Chains in Circular Product-Service-Systems .....	111
<i>Julian Grosse Erdmann, Jan Koller, Saman Amir, Aleš Mihelič, and Frank Döpfer</i>	
Concept of Sustainable Supply Chain Management Using Multi-agent System: Negotiation by Linear Physical Programming .....	119
<i>Jundai Koketsu, Aya Ishigaki, Hiromasa Ijuin, and Tetsuo Yamada</i>	
Designing a Reverse Supply Chain Network for Smartphones with Material-Based GHG Emissions and Costs Using Linear Physical Programming .....	127
<i>Hiromasa Ijuin, Takaki Nagao, Masakuni Tsunetzawa, Kohei Sugiyama, Kazuyuki Tasaka, and Tetsuo Yamada</i>	
<b>Machine Tools</b>	
Influence of Additivation of Bio-Based Lubricants on Sprayability and Solubility for Cryogenic Minimum Quantity Lubrication .....	139
<i>Trixi Meier, Michael Lermer, Daniel Gross, and Nico Hanenkamp</i>	
Potential of Radar Based Measuring Systems in Hot Forging .....	148
<i>M. Bergmann, M. Dix, T. Wallbaum, and R. Selbmann</i>	
Evaluation of Thermal Error Compensation Strategies Regarding Their Influence on Accuracy and Energy Efficiency of Machine Tools .....	157
<i>Christian Naumann, Axel Fickert, Lars Penter, Carola Gißke, Eric Wenkler, Janine Glänzel, Philipp Klimant, and Martin Dix</i>	
Investigation of Cutting Force and Surface Quality in Frozen Wood Sawing Under Varying Influencing Factors to Improve the Energy- and Resource Efficiency of Sawing Processes .....	166
<i>F. Schreiner, J. Schmidt, B. Thorenz, M. Voigt, and F. Döpfer</i>	

<b>revolPET®: An Innovative “Back-to-Monomer” Recycling Technology for the Open Loop Value Chain of PET and Polyester Composite Packaging and Textiles</b> .....	175
<i>Renan Louro Cardoso Franco, Carsten Eichert, Charlotte Lücking, Lars Biermann, Mandy Paschetag, and Stephan Scholl</i>	
<b>Development of a Pneumatic Clamping System with Position and Force Control Machining</b> .....	184
<i>U. Ben-Hanan, U. Eckert, M. Mende, A. Weiss, R. Wertheim, and U. Azaria</i>	
<b>Initial Period of Chip Formation: Observations Towards Enhancing Machining Sustainability</b> .....	193
<i>Y. Alammari, J. Saelzer, S. Berger, I. Iovkov, and D. Biermann</i>	
<b>Influence of Carbon Dioxide Temperature on Sprayability and Solubility in Cryogenic Minimum Quantity Lubrication with Bio-Based Lubricants</b> .....	202
<i>Trixi Meier, Michael Lerner, Daniel Gross, and Nico Hanenkamp</i>	
<b>Sustainability Enhancement of the Coal Based Direct Reduction of Iron Premised on a Rotary Kiln</b> .....	211
<i>Ratidzo Yvonne Nyakudya and Michael Ayomoh</i>	
<b>The Influence of the Rake Angle on the Cutting of Low-Lead and Lead-Free Brass Alloys</b> .....	219
<i>Magdalena S. Müller and Knut Sørby</i>	
<b>Materials</b>	
<b>Towards Making Polymer Food Packaging Suitable for the Circular Economy: Cleanliness is Next to Godliness</b> .....	231
<i>Elliot Woolley, Mala Sian, Samsun Nahar, Nikki Clark, Fiona L. Hatton, Ryan Larder, Rhoda Trimmingham, and Garrath T. Wilson</i>	
<b>CO<sub>2</sub> Footprint of Machine Elements Made of Fiber-Reinforced Polymer Concrete Compared to Steel Components</b> .....	240
<i>Kim Torben Werkle, Michelle Engert, and Hans-Christian Möhring</i>	
<b>Evaluation of Material Properties of Spruce Wood Samples to Improve the Development Process for More Sustainable Sawing Processes</b> .....	249
<i>J. Schmidt, F. Schreiner, B. Thorenz, and F. Döpfer</i>	

Liquid Desiccant Dehumidification Systems: Jet Cross-Talking Effect in Multi-electrosprays .....	258
<i>Winnie Mutenhabundo, Tawanda Mushiri, Timothy Gutu, and Patson Zvandasara</i>	
High Strength and Electrical Conductivity of $\alpha$ -Al-CNTs + GAgNPs Nanocomposites .....	266
<i>Victor Sunday Aigbodion</i>	
Material Recycling of End-of-Life Tires: The Influence of Recyclates on the Processing of Rubber Compounds .....	273
<i>Stefan Hoyer and Lothar Kroll</i>	
<b>Additive Manufacturing</b>	
Potential Analysis for the Use of Bio-Based Plastics with Natural Fiber Reinforcement in Additive Manufacturing .....	285
<i>Andreas Friedel and Stefan Junk</i>	
Development of Magnetic Sheets for CO <sub>2</sub> Efficient Electric Drives Using an Additive Manufacturing Approach .....	294
<i>Alexander Schmidt, Marco Ziegler, Jörg Franke, and Alexander Kuehl</i>	
Towards a Comparative Index Assessing Mechanical Performance, Material Consumption and Energy Requirements for Additive Manufactured Parts .....	302
<i>Leopoldo De Bernardez, Giampaolo Campana, Mattia Mele, and Sebastian Mur</i>	
A Framework to Compute Carbon Emissions Generated from Additive Manufacturing Processes .....	311
<i>Vasiliki C. Panagiotopoulou, Aikaterini Paraskevopoulou, and Panagiotis Stavropoulos</i>	
Competencies to Address the Industrial Additive Manufacturing Towards Sustainable Production .....	320
<i>Gustavo Melo, Alexander Kies, Stefanie Paluch, and Johannes Henrich Schleifenbaum</i>	
Modeling Carbon Border Tax for Material-Based GHG Emission and Costs in Global Supply Chain Network .....	328
<i>Takaki Nagao, Hiromasa Ijuin, Keisuke Nagasawa, and Tetsuo Yamada</i>	

## Production Systems

Integrating Lean Management Principles into Human-Robot Collaboration in Disassembly Cell .....	339
<i>Samira Keivanpour</i>	
A Mathematical Model Considering Multi-skilled Operators and Industrial Robots on Reconfigurable Manufacturing Cells .....	349
<i>Takayuki Kataoka</i>	
5S Implementation to Minimize Waste in Bread Production Process (Case Study: Madani Bakery) .....	357
<i>Nilda Tri Putri, Dicky Fatrias, and Santa Rosa Roberta Simbolon</i>	
Environmental Assessment and Optimization When Machining with Micro-textured Cutting Tools .....	364
<i>Amr Salem, Hussien Hegab, and Hossam A. Kishawy</i>	

## Planning, Scheduling and Control

Waste Minimization by Inventory Management in High-Volume High-Complexity Manufacturing Organizations .....	375
<i>Mohamed Afy-Shararah, Sandeep Jagtap, Emanuele Pagone, and Konstantinos Salonitis</i>	
Cascaded Scheduling for Highly Autonomous Production Cells with AGVs .....	383
<i>Eddi Miller, Tobias Kaupp, and Jan Schmitt</i>	
A Model to Balance Production Workload Distribution in a Trailer Manufacturing Organisation Under Fluctuating Customer Ordering Condition .....	391
<i>Gerhard van der Walt, Olasumbo Makinde, and Khumbulani Mpofo</i>	
Enabling Sustainable Consumption: Development of an Inventory Management Tool for Food Recovery .....	401
<i>Chelsea Dean, Fazleena Badurdeen, and Kendra OoNorasak</i>	
Resource-Efficient Process Chains for the Production of High-Performance Powertrain Components in the Automotive Industry .....	410
<i>Berend Denkena, Benjamin Bergmann, Marcel Wichmann, Miriam Handrup, Daniel Katzsch, Philipp Pillkahn, Leon Reuter, Christopher Schmidt, and Frederik Stelljes</i>	

**Optimizing Product Life Cycle Systems for Manufacturing in a Circular Economy** ..... 419  
*Buddhika M. Hapuwatte, Nehika Mathur, Noah Last, Vincenzo Ferrero, Maya Reslan, and K. C. Morris*

**Energy Efficiency**

**Development of a Holistic Framework for Identifying Energy Efficiency Potentials of Production Machines** ..... 431  
*Borys Ioshchikhes, Daniel Piendl, Henrik Schmitz, Jasper Heiland, and Matthias Weigold*

**Simulation-Based Efficiency Comparison of Different Mains Configurations for DC Grid Branches for Supplying Production Plants Based on a Rule-Compliant Design** ..... 440  
*Benjamin Gutwald, Freddy Ngankam Ndjiemni, Martin Barth, and Jörg Franke*

**Increasing Energy Efficiency and Flexibility by Forecasting Production Energy Demand Based on Machine Learning** ..... 449  
*André Trenz, Christoph Hoffmann, Christopher Lange, and Richard Öchsner*

**The Use of Gentani Approach for Benchmarking Resource Efficiency in Manufacturing Industries** ..... 457  
*Shoaib Sarfraz, Mark Jolly, and Konstantinos Salonitis*

**Increase Efficiency of Energy Transmission by Incentives** ..... 464  
*Benjamin Jacobsen*

**User-Centric Energy Efficiency Optimization for Machining** ..... 472  
*Thore Gericke, Volkmar Thomsen, Nik Schwichtenberg, and Alexander Mattes*

**Method for Evaluating and Identifying Energy-Efficient Process Chains for the Manufacturing of Press Hardening Tools Based on the Deming Circle** ..... 481  
*Anja Rautenstrauch, Larisa Markov, and Verena Kräusel*

**Approach for Design of Low Carbon Footprint Paint Shops in the Automotive Industry** ..... 490  
*Jonas Wendt, Astrid Weyand, Boris Barmbold, and Matthias Weigold*

A Practical Approach to Realize a Closed Loop Energy Demand  
 Optimization of Milling Machine Tools in Series Production ..... 499  
*Alperen Can, Hendrik Schulz, Ali El-Rahhal, Gregor Thiele,  
 and Jörg Krüger*

Load Profile Optimization Using Electricity Wholesale Market Price  
 Data for Discrete Manufacturing ..... 508  
*Clemens Schwaiger, Thomas Trautner, and Friedrich Bleicher*

**Industry 4.0 and Digitalization**

Conceptual Framework of a Digital Twin Fostering Sustainable  
 Manufacturing in a Brownfield Approach of Small Volume Production  
 for SMEs ..... 519  
*Sandra Krommes and Florian Tomaschko*

Pharma 4.0: Revealing Drivers of the Digital Transformation  
 in the Pharma Sector ..... 528  
*Michelle Grace Tetteh, Sandeep Jagtap, and Konstantinos Salonitis*

A Case Study on Evaluation of Defect Characteristics for Practical  
 Application of Appearance Inspection Work Support System Utilizing  
 Deep Learning ..... 536  
*Yuta Nakakura, Kosuke Temizu, Mana Nishino, and Ryosuke Nakajima*

Framework for the Development and Implementation of Sustainable  
 Information Systems for the Digitalization of Small Businesses in South  
 Africa ..... 542  
*Ryan Parker and Stephen Matope*

Sustainable Solutions by the Use of Immersive Technologies  
 for Repurposing Buildings ..... 551  
*Maximilian Rosilius, Markus Wilhelm, Ingo von Eitzen,  
 Steffen Decker, Sebastian Damek, and Volker Braeutigam*

Development of a Potential Analysis for the Introduction of Sustainable  
 Digitization Solutions ..... 559  
*Tanja Steinbach, Franziska Parthey, Markus Weidmann,  
 and Reiner Anderl*

Industrial Digital Twin in Industry 4.0: Enabling Service Exchange  
 Between Assets in Manufacturing Systems ..... 567  
*Tim van Erp, Frederik Bredahl Pedersen, Niels Peter Lamm Larsen,  
 and Rasmus Bæk Lund*



Digital Twins for Sustainability in the Context of Biological Transformation .....	576
<i>Anne Seegrün, Janine Mügge, Theresa Riedelsheimer, and Kai Lindow</i>	
Virtual Experiments for a Sustainable Battery Cell Production .....	585
<i>Jonathan Krauß, Thomas Ackermann, Alexander D. Kies, David Roth, and Miriam Mitterfellner</i>	
Conceptual Approach for a Digital Value Creation Chain Within the Timber Construction Industry – Potentials and Requirements .....	595
<i>N. Schramm, N. Oertwig, and H. Kohl</i>	
Smart Manufacturing Systems for Small Medium Enterprises: A Conceptual Data Collection Architecture .....	604
<i>M. G. Kanakana-Katumba, R. W. Maladzi, and M. O. Oyesola</i>	
Key Enablers of Industry 5.0 - Transition from 4.0 to the New Digital and Sustainable System .....	614
<i>Maja Trstenjak, Miro Hegedić, Nataša Tošanović, Tihomir Opetuk, Goran Đukić, and Hrvoje Cajner</i>	
Establishment of an Appropriate Data Analytic Platform for Developing a Wisdom Manufacturing System Using Decision Techniques .....	622
<i>Emanuel Fernando Zeferino, Khumbulani Mpofu, Olasumbo Makinde, and Boitumelo Ramatsetse</i>	
Implementation Framework for Blockchain-Based Traceability to Tackle Drug-Counterfeiting: Embracing Sustainable Pharma Logistics Networks .....	630
<i>Benjamin Nitsche, Frank Straube, Tom-Li Kämper, and Simon Zarnitz</i>	
A Hybrid Structural Interaction Matrix Approach to Prioritise Process Wastes Generated in a Manufacturing Organisation .....	638
<i>Olasumbo Makinde, Thomas Munyai, and Edgar Nesamvuni</i>	
Modelling and Simulation of Pump Impeller Produced Using Fused Deposition Modelling .....	647
<i>Rumbidzai Muvunzi, Ilesanmi Daniyan, Festus Fameso, and Khumbulani Mpofu</i>	
<b>Life Cycle and Decision Making</b>	
Framework for Sustainability in Aerospace: A Proof of Concept on Decision Making and Scenario Comparison .....	659
<i>Marco Franchino</i>	

Environmental Assessment of Recycled Petroleum and Bio Based Additively Manufactured Parts via LCA .....	669
<i>Christian Bay, Niko Nagengast, Hans-Werner Schmidt, Frank Döpfer, and Christian Neuber</i>	
Screening Life Cycle Assessment of Thermoacoustic Panels from Agricultural Byproducts .....	678
<i>Rodrigo Salvador, Gabriela Aparecida Chapieski, Leandro Inagaki Oshiro, Eduardo Bittencourt Sydney, and Antonio Carlos de Francisco</i>	
A Model Calculation of CO <sub>2</sub> Emissions Saving Potential for Fine Blanking of Inductively Heated Sheet Metal with Comparison of the Product Variants .....	685
<i>Ingo Felix Weiser, Tim Herrig, and Thomas Bergs</i>	
Considering LCA in System Architectures of Smart-Circular PSS .....	694
<i>Thomas Kruschke, Theresa Riedelsheimer, and Kai Lindow</i>	
Dynamic LCA and LCC with ECOFACT .....	703
<i>Emilia Ingemarsdotter, Sahil Singhanian, and Georgios Pallas</i>	
Sustainability Assessment of Aerospace Manufacturing: An LCA-Based Framework .....	712
<i>Yousef Haddad, Sandeep Jagtap, Emanuele Pagone, and Konstantinos Salonitis</i>	
Concept for the Evaluation and Categorization of Sustainability Assessment Methods and Tools .....	721
<i>Niklas Quernheim, Sven Winter, Lars Arnemann, Steffen Wolff, Reiner Anderl, and Benjamin Schleich</i>	
Techno-Economic Assessment of Biogas to Liquid Fuel Conversion via Fischer-Tropsch Synthesis: A Case Study of Biogas Generated from Municipal Sewage .....	729
<i>Munasho Katiyo, Loice Gudukeya, Mufaro Kanganga, and Nita Sukdeo</i>	
Model-Based Method for Low-Effort Part-Specific CO <sub>2</sub> -Accounting During the Production on Machine Tools Using PLC Data .....	738
<i>Erkut Sarikaya, Astrid Weyand, Dominik Dück, and Matthias Weigold</i>	

**Product Design and Innovation**

Approach to Reduce the Environmental Impact of a CNC Manufactured Product in the CAD Phase ..... 749  
*Sven Winter, Niklas Quernheim, Lars Arnemann, Reiner Anderl, and Benjamin Schleich*

The LaST Tool – The Longevity and Sustainable Transition Tool ..... 757  
*Peter Byrial Jensen, Louise Møller Haase, Tim Cooper, Joseph Steward, Phillipa Marsh, and Linda Nhu Laursen*

A Fuzzy Sustainable Quality Function Deployment Approach to Design for Disassembly with Industry 4.0 Technologies Enablers ..... 772  
*Samira Keivanpour*

Identification of Product Specifications Based on KANO Model and Application to Ecodesign ..... 781  
*Nozomu Mishimar*

Concept and Implementation of a Student Design Project for the Development of Sustainable Products ..... 790  
*Johanna Wurst, Daniel Rosemann, Iryna Mozgova, and Roland Lachmayer*

Classifying Multi-generational Products for the Circular Economy ..... 799  
*Buddhika M. Hapuwatte, Fazleena Badurdeen, and I. S. Jawahir*

Design for Sustainability in Manufacturing – Taxonomy and State-of-the-Art ..... 808  
*Vivien Langer, Annika Tampe, and Uwe Götze*

**Learning and Knowledge**

Serious Games in Academic Education – A Multi-dimensional Sustainability Analysis of Additive Versus Conventional Manufacturing Technologies in a Fictitious Enterprise Project ..... 819  
*Christiane Rauch, Oliver Maurer, Sven-Erik Lang, and Dirk Bähre*

Conversion of a Manufacturing Lab as a Learning Factory to Educate Factories of the Future Concept ..... 827  
*Smirthya Somaskantha Iyer, Nuwan Dissanayaka, Asela K. Kulatunga, and Mahanama Dharmawardhana*

Evaluation of Competencies for a Sustainable Industrial Environment ..... 836  
*G. Campana, M. Mele, L. De Bortoli, B. Cimatti, and H. Kobayashi*

Federated Learning for Privacy-Preserving Collaboration in Smart Manufacturing .....	845
<i>Jianjing Zhang, Clayton Cooper, and Robert X. Gao</i>	
Immersive Virtual Work Integrated Learning: A Development of an Interactive Learning Environment for Rail Components Manufacturing .....	854
<i>Nokulunga Zamahlubi Dlamini, Khumbulani Mpopu, Boitumelo Ramatsetse, and Olusambo Makinde</i>	
A Proposed System for Greening Higher Education Institutions in Palestine .....	862
<i>Ahmed Abu Hanieh and Afif Akel Hasan</i>	
Exploring the Potential of Open Source Machine Tools for Sustainable Industrial Development in Low Resource Contexts - A Case Study of Migrant-Run Microenterprises in Oman .....	872
<i>Mohammed Omer, Melina Kaiser, Tobias Redlich, and Jens P. Wulfsberg</i>	
<b>Assessment, Strategy and Business Models</b>	
Holistic Approach to the Ecological Evaluation of Digitalization Systems in the Production Environment .....	883
<i>Florian Tomaschko and Sandra Krommes</i>	
Development of a Sustainability Strategy for Fuel Cells Using Life Cycle Analysis and Expert Interviews .....	892
<i>Patrick Rückert, Aigul Khabipova, and Kirsten Tracht</i>	
A New Business Model for the Circular Economy of Electric Vehicles .....	901
<i>Parnia Shafinejad, Konstantinos Georgopoulos, Michael Bolech, and Giacomo Copani</i>	
Design Model for the Sustainability Management of Manufacturing Companies .....	910
<i>Felix Sohnius, Martin Iglauer, and Robert H. Schmitt</i>	
Integration of Digitization and Sustainability Objectives in a Maturity Model-Based Strategy Development Process .....	918
<i>Marc Münnich, Maximilian Stange, Marian Süße, and Steffen Ihlenfeldt</i>	

Implications of Strategic Orientation on Sustainable Performance and Organizational Innovation: A Case of Manufacturing SMEs in Sub-Saharan Africa .....	927
<i>Peter Onu, Anup Pradhan, and Charles Mbohwa</i>	
Identification of Action Areas for the Promotion of Local Manufacturing in Reference to System Theory .....	936
<i>Pascal Krenz, Lisa Stoltenberg, Dominik Saubke, and Julia Markert</i>	
Role of Recycling Towards a Sustainable Business Model: A Perspective on Industrial Assets .....	945
<i>Daniel Wörner and Thomas Friedli</i>	
Consumer Perceptions of the Circular Business Model: A Case of Leasing Strollers .....	953
<i>Farazee M. A. Asif, Niloufar Salehi, and Michael Lieder</i>	
Guideline for Identifying Required Data Granularity for Deriving Improvements to the Environmental Impact of Production .....	961
<i>Michel Kaufmann, Henry Ekwaro-Osire, and Klaus-Dieter Thoben</i>	
Sustainability Impacts of Global Used Clothing Trade and Its Supply Chain .....	970
<i>Kanchana Dissanayake and Rudrajeet Pal</i>	
<b>Metrics</b>	
Taxonomy for Biological Transformation Principles in the Manufacturing Industry .....	981
<i>Magda Berkhahn, Gerald Kremer, Theresa Riedelsheimer, Kai Lindow, and Rainer Stark</i>	
An Empirical Investigation into Path Dependency and Embeddedness Among Sustainable Manufacturing Capabilities Envisaged in the Natural Resource-Based View of the Firm .....	990
<i>Bhavya Pande, Gajendra Kumar Adil, Diksha Vashisht, and Sanchayan Mitra</i>	
Empirical Investigation of Climate Neutrality Strategies of Companies in Industrial Production .....	999
<i>Stefan Seyfried, Lukas Nagel, and Matthias Weigold</i>	

Developing a Manufacturing Process Level Framework for Green Strategies KPIs Handling ..... 1008  
*Vasiliki C. Panagiotopoulou, Alexios Papacharalampopoulos, and Panagiotis Stavropoulos*

Combining Research-, Project-, and Case-Based Learning in Higher Manufacturing Engineering Education ..... 1016  
*Tim van Erp*

**Sustainability at Regional Level**

Converted and Shared Light Electric Vehicles in Ghana: A Technical and Economic Analysis Based on Converted ICE Motorbikes and e-mopeds ..... 1027  
*Frederick Adjei, Denise Sperling, Isaac Atia-Abugbilla, Arnold Anokye, Jorge Appiah, Godwin Ayetor, and Semih Severengiz*

New Insights into the Polymer Coating of Mild Steel Using Activated Orange Juice Functionalized Rice Husk Nanoparticles ..... 1037  
*V. S. Aigbodion and P. A. Ozor*

Supply Chain Reconfiguration as an Option to Mitigate Post Harvest Losses and GHGs: Simulating a Case Study from Banana Supply Chain in Sri Lanka ..... 1044  
*M. K. D. C. K. Chandrasiri, U. S. S. Dharmapriya, A. K. Kulatunga, R. M. R. N. K. Ratnayake, W. M. C. B. Wasala, and W. A. P. Weerakkody*

Design of a Sustainable Rescue and First Aid Drone-Based System for Passenger Car Occupants ..... 1053  
*Marvellous Moyo, Tawanda Mushiri, and Habib Noorbhai*

**Student Projects**

Leveraging Insights from Unique Artifacts for Creating Sustainable Products ..... 1065  
*H. Zannoun, J. Okorafor, T. Asensio, G. Guedes, F. Badurdeen, P. Wang, I. S. Jawahir, G. Campana, M. Mele, and B. Cimatti*

Literature Review of Biological Transformation in Holistic Production Systems ..... 1074  
*Annika Lange and Moritz Poeche*

Evaluating the Sustainability of Paper and Plastic Substitute Material LimeX .....	1082
<i>E.-Lexus Thornton, Avery Hartley, Daniel Caudill, Martin Gamesu, Julius Schoop, and Fazleena Badurdeen</i>	
Requirements for the Development of a Performance Management System with Consideration of Unforeseeable Business Process Variants .....	1091
<i>Yu-Min Teng, Sila Ay, Rishabh Iyer, and Julia-Anne Scholz</i>	
Correction to: Resource-Efficient Process Chains for the Production of High-Performance Powertrain Components in the Automotive Industry .....	C1
<i>Berend Denkena, Benjamin Bergmann, Marcel Wichmann, Miriam Handrup, Daniel Katzsch, Philipp Pillkahn, Leon Reuter, Christopher Schmidt, and Frederik Stelljes</i>	
<b>Author Index .....</b>	<b>1099</b>

# **Manufacturing Processes**





# 3D-Printed MWF Nozzles for Improved Energy Efficiency and Performance During Grinding

Robert Zmich<sup>1,2</sup>✉ and Carsten Heinzel<sup>1,2</sup>

<sup>1</sup> Leibniz Institute for Materials Engineering - IWT, Division Manufacturing Technologies,  
Badgasteiner Street 3, 28359 Bremen, Germany

zmich@iwt-bremen.de

<sup>2</sup> Faculty of Production Engineering and MAPEX Center for Materials and Processes,  
University of Bremen, Bibliothekstr. 1, 28359 Bremen, Germany

**Abstract.** Particularly during grinding of metal workpieces, a high energy consumption is required during the main process times, so that the resulting energy costs represent a significant amount of the total operating costs of the machine tool. In this context, the supply of metal working fluids (MWF) during the grinding process is often associated with a high energy consumption, but the MWF supply strategy (MWF flow rate, MWF nozzle, control and dimensioning of the MWF supply pumps) can significantly influence the energy efficiency of such processes. In the scope of this work, additive manufacturing was used to produce fluid supply nozzles adapted to the respective grinding process. In this work, it was shown that by using a flow-optimized nozzle the required power of the MWF supply pump can be significantly reduced, allowing to make the grinding process more efficient in terms of the energy required.

**Keywords:** Grinding · MWF supply · Energy efficiency · Additive manufacturing

## 1 Introduction

For the evaluation of production facilities and manufacturing processes with regard to energy efficiency, the specific energy is a useful parameter, since it can be used to describe the ratio of the energy input to a suitable functional unit of the product or service [1–3]. Thus, the energy consumption at the machine tool during steel manufacturing is considered and energy-saving solutions are derived from it. Based on the knowledge of the energy consumption of individual machine tools, energy efficient process chains can be designed [4]. For an objective evaluation of the energy efficiency, however, the applicability of the respective manufacturing process for achieving the required workpiece properties must be taken into account [3, 5, 6].

In grinding processes, the specific grinding energy – the ratio of the spindle power to the material removal rate – provides information about the energy consumption at the grinding spindle during the machining of a material volume unit and can therefore be used to evaluate the energy efficiency of the machining process during grinding. A

process optimization, which enables a reduction of the process forces or the spindle power at a constant material removal rate, leads to a decrease of the specific grinding energy and thus to an increase of the energy efficiency of the grinding process [7–9].

During the machining process, the total energy consumption of the machine tool results from the energy demand of the individual modules involved in the process. Thus, the energy consumption is influenced by the equipment of the machine tool or by the energy efficiency of individual modules. In this context, it should be noted that the largest energy consumer on a machine tool (machining center or grinding machine) is usually the metalworking fluid (MWF) supply system, so that a significant potential for increasing energy efficiency can be seen here [10].

During the grinding machining of metal workpieces with conventional and high-hardness grinding tools, fluid supply in flood mode remains the most commonly used type of fluid supply in the industry, due to strong heat generation in the grinding contact zone or a high risk of thermal workpiece damage. By optimizing the fluid supply, the achievable material removal rate and the workpiece quality can be increased on the one hand, and on the other hand the required fluid flow rate and thus the energy consumption of the fluid system can be reduced. This increases the energy efficiency of the process and the grinding machine [7]. A significant factor for fluid optimization is the shape of the nozzle, which, in addition to the shape of the fluid jet, influences the energy required for fluid supply. Savings in the energy consumption of fluid supply pumps of more than 50% can be achieved without compromising the fluid jet shape and thus the cooling lubrication of the grinding contact zone, whereby the use of frequency-controlled pumps is required [11].

In the context of this work, this aspect is addressed in the following and the use of additive manufacturing for nozzle production is investigated. Due to the many degrees of freedom that additive manufacturing brings along, complex internal geometries and internal structures can be realized, which can positively influence the shape of the jet and thus the energy efficiency of the entire grinding process. The aim of the investigation presented here is to compare the different nozzle geometries and to evaluate them with regard to energy efficiency.

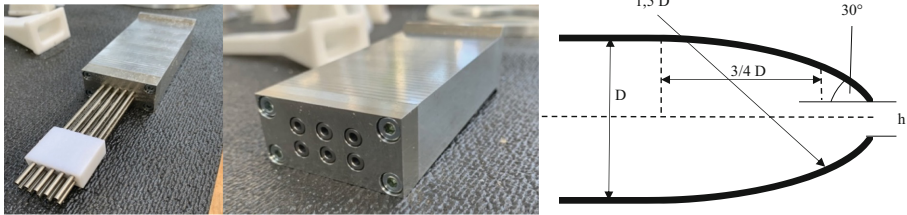
## 2 Materials and Methods

### 2.1 MWF Supply Nozzles

In this work, two reference nozzles (modular and needle nozzle) were compared with two flow-optimised printed nozzles and evaluated with regard to their performance in the grinding process and their energy efficiency.

The modular nozzles use nozzle inserts, which were arranged as shown in Fig. 1 (right) and which cover the grinding wheel width of 20 mm. In the case of the needle nozzle, a similar basic body was manufactured, which holds thin tubes with a diameter of 2 mm along a width of also 20 mm. With the help of the different outlet cross-sections of the individual nozzle cores or the tubes, it was possible to realise an identical outlet cross-section, whereby the same jet flow velocity of 35 m/s can be set. When designing the nozzles, it was ensured that the flow speed corresponded to the peripheral speed of the grinding wheel, as studies have shown that a flow speed of the grinding fluid adapted

to the peripheral speed of the grinding wheel has a positive influence on the grinding result.



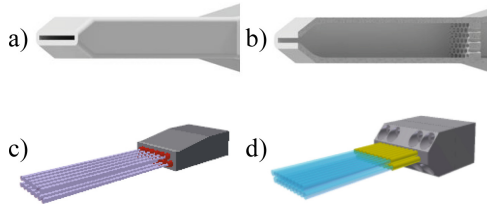
**Fig. 1.** Reference nozzles used; left: Needle nozzle; middle: Modular nozzle; right: Rouse-nozzle profile based on Rouse et al. and Webster et al. [12, 13]

For the flow-optimised nozzle, the design was based on that of Rouse [12]. According to Rouse, the nozzle shape, shown in Fig. 2, was first developed in connection with fire extinguishing systems. The concept of the round nozzle shape was then subsequently transferred by Webster to a two-dimensional square nozzle for fluid supply during grinding [14].

A typical MWF nozzle is characterized by abrupt local changes in cross-section (tapering). This means that the stream of the flowing media is prone to local high degree of turbulence and loss of pressure, which has a considerable effect on jet coherence. In contrast, the transitions in the cross section of a Rouse nozzle are smooth. This shape prevents the formation of turbulent boundary layers and thus reduces the risk of stalls. Studies have shown that the Rouse nozzle is very efficient compared to other nozzle shapes, as it allows to produce the longest coherent jet [13].

The positive effect of honeycomb structures and guiding elements on a flow has already been shown in earlier investigations [13]. In order to examine the influence of these structures in front of a cooling lubricant nozzle, a variant of the Rouse nozzle with a honeycomb structure was investigated (see Fig. 3). According to Loehrke and Nagib, honeycomb structures must be long enough to redefine the velocity profile. At the same time, however, the pressure loss increases with increasing length [15]. Studies by Szolcek show that the lowest pressure loss can be generated at a length/diameter ratio of about 4:1 [16]. Each honeycomb used in this work has a diameter of 1.5 mm. This results in a total length of 6 mm for the honeycomb.

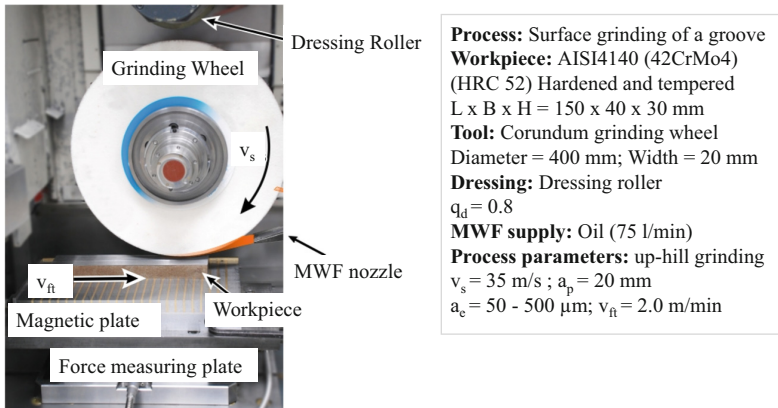
The additive manufacturing of the nozzles is carried out using the 3D printer “Form2” from the company Formlabs. This printer works on the principle of stereolithography (SL). The material used for printing was a glass-reinforced resin, which has an increased tensile modulus of 4000 Pa and a high surface quality, which has a positive effect on the roughness of the nozzles. The nozzles were printed with the lowest layer height of  $50 \mu\text{m}$  in order to print as smooth a surface as possible. The printed nozzles were then cured under UV light to further enhance the mechanical properties.



**Fig. 2.** Sketch of the investigated nozzles: a) 3D-printed nozzle; b) 3D-printed nozzle with honeycombs; c) modular nozzle; d) needle nozzle

## 2.2 Experimental Setup and Analysis

In order to evaluate the manufactured nozzles in the grinding process, surface grinding tests were carried out in which the nozzles supply the metalworking fluid. The experimental environment with the process parameters is shown in the following Fig. 3.



**Fig. 3.** Experimental environment including process parameters

The nozzles were all positioned at an angle of  $10^\circ$  and a distance of 100 mm from the point of contact between the workpiece and the nozzle outlet. The needle nozzle represents an exception. The needle nozzle was positioned at a distance of 20 mm in order to take into account the advantage of the extremely good accessibility due to the thin tubes in the investigations.

To evaluate the resulting forces in the grinding process, the tangential and normal forces were recorded during the process with the use of a measuring force plate under the workpiece to be ground. The required spindle power, which is also used as a parameter for assessing the nozzles, was obtained directly from the spindle.

The presence of thermal damage was defined as the process limit of the respective nozzles, which was identified by the Barkhausen noise measurement. This method is suitable due to the fact that the micromagnetic signal to characterize the surface and subsurface integrity of the ground workpiece surface is strongly dependent on material

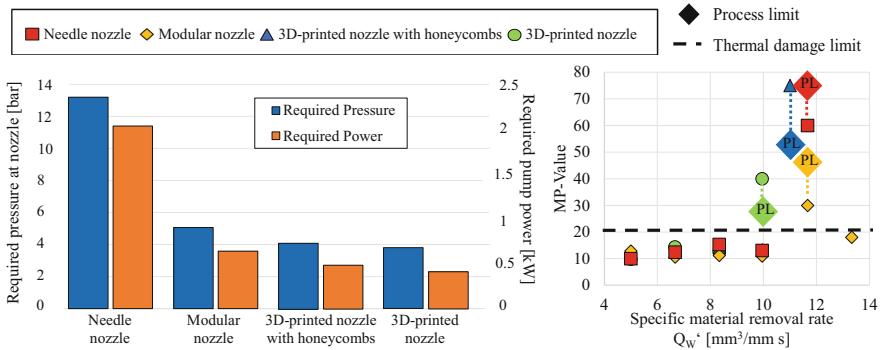
modifications, such as yielding and phase transformations due to thermomechanical influence, and is therefore able to identify grinding burn [17]. For this purpose, it was first necessary to identify the reference value range for thermally undamaged samples on the basis of reference samples (only pre-machined and heat-treated). In addition, selected metallographic examinations were carried out to validate the Barkhausen noise measurement.

### 3 Results and Discussion

In this section, all aspects of the examined nozzles are discussed in order to compare them. At the beginning, variables such as the required pressure and the associated pump power were looked at regardless of the grinding process itself, which are needed to set the required jet parameters.

Afterwards, variables such as the resulting grinding forces, the process limits and the required grinding power are compared with each other. With the help of the measured values, a comparison can be made with regard to energy efficiency, which makes it possible to evaluate the nozzles.

The recorded pressures and pump powers when using the respective nozzles are shown in the following Fig. 4.



**Fig. 4.** Required pressure and pump power at the nozzle for each nozzle and process limits for the different nozzles

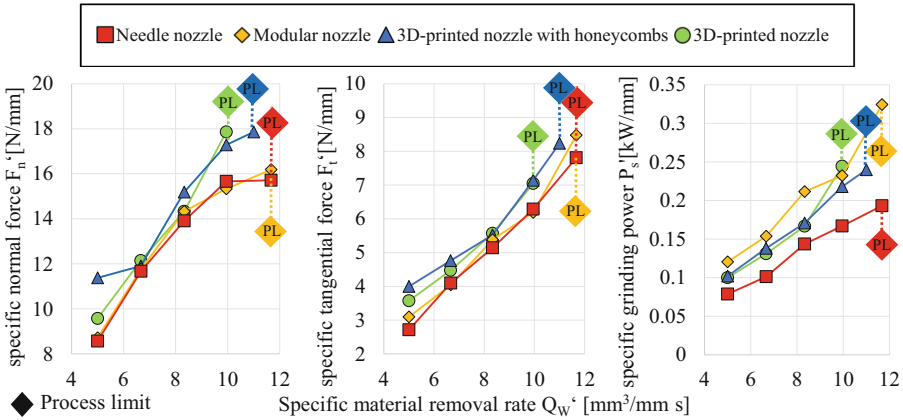
It is evident that the highest pressure and correspondingly the highest pump power is required for the needle nozzle. Due to the optimised nozzle geometry, the 3D printed nozzles require less energy to achieve the required jet velocity of  $v_s = v_{jet} = 35$  m/s with the identical outlet cross-sections. As expected, the use of honeycombs in the 3D printed nozzle requires increased pressure and pump power. This behaviour was to be expected, as an increased resistance due to the small channels occurs in the form of higher wall friction effects, similar to the small channels of a needle nozzle.

To determine the process limit of the respective nozzle, the depth of cut  $a_e$  was increased further and further until a thermal influence occurred. In Fig. 4, the process limits are plotted evaluating the measured Barkhausen noise. A strong increase

of the magnetic parameter (MP) value is a first indicator of thermal influences, as the magnetization process is influenced by structural changes. In this paper an undamaged workpiece has an MP value of 20. A value above this limit provides evidence of first thermal influences on the microstructure.

When considering the process limits, it becomes clear that the reference nozzles and the use of honeycomb structures are beneficial. Despite the increased energy requirement, the straightening of the flow through the honeycomb structures leads to an increase in the performance of the grinding process.

Figure 5 illustrates the resulting process forces and the spindle powers using the considered MWF nozzles.



**Fig. 5.** Comparison of the process forces and spindle power of the investigated nozzles

The process forces and spindle power turn out to be lowest with the needle nozzles while at the same time requiring the highest pressure and pump power. In addition, the use of a honeycomb structure has a negative effect on the process forces. Compared to the needle nozzle, the use of the printed nozzle produces similar process forces, but requires a higher spindle power. The highest specific material removal rates (12 mm<sup>2</sup>/mm s) without thermal damage can be achieved with the needle and modular nozzle.

Based on the knowledge gained, the specific energy for all nozzle concepts used was determined. The extended approach, which was applied in the context of this work, includes not only the spindle power ( $P_c$ ) but also the power from the fluid supply pump ( $P_{cl}$ ) and the base power of the grinding machine ( $P_{bp}$ ) (constant at 2kW) (see Eq. 1), whereby the entire grinding process is covered and a realistic consideration of the energy consumption can be done [9].

$$e_{total} = e_c + e_{bp} + e_{cl} = \frac{P_c}{Q_w} + \frac{P_{bp}}{Q_w} + \frac{P_{cl}}{Q_w} \left[ \frac{W \cdot s}{mm^3} \right] \quad (1)$$

Another aspect is the achievable process limit, which strongly depends on the process input variables (tool and process parameters) or the process control. Thus, an evaluation of different fluid supply concepts can be carried out when using a decentralised fluid

supply. The diagrams of the specific energy (energy efficiency diagrams) elaborated serve to evaluate the investigated nozzle designs and different materials with regard to their achievable process limit, the energy consumption required for this and with regard to the resulting energy efficiency of the entire grinding process. An external power analyser of the type WT500 from YOKOGAWA was used to measure the grinding power at the grinding spindle. Also the power for the fluid supply was measured directly at the frequency converter of the supply pump (Fig. 6).

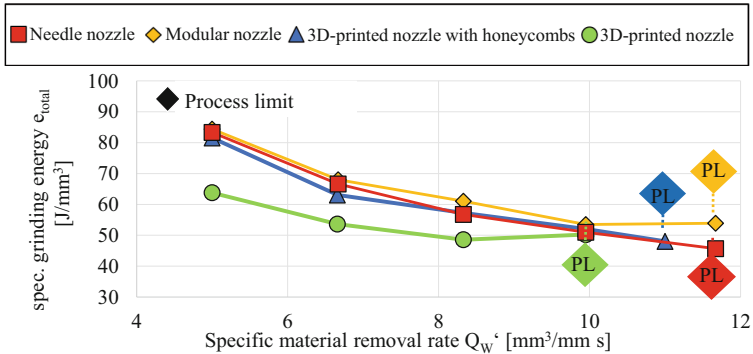


Fig. 6. Specific total energies for all examined nozzles

Despite the high pump power requirement using the needle nozzle, which has already been demonstrated, the specific energies are equivalent to those of the modular nozzle and the 3D-printed nozzle with honeycomb. This is due to the efficient cooling and lubrication during the grinding process, which ensures that a lower spindle power is needed. In comparison to the reference nozzles, the 3D-printed nozzle allows the most energy-efficient use, whereby the process limit is the lowest.

## 4 Conclusions

In this work, it was shown that 3D printing can be used to create efficient MWF nozzles. With the help of 3D printing, it was possible to produce the internal geometry flow-optimised to the respective grinding task. In particular, the use of flow straightener in the form of honeycomb structures can have a significant positive influence on the jet shape in the case of extremely turbulent flow into the nozzle. However, it was also shown that the use of needle nozzles provides the best positive effect on the spindle power during the process. For this reason, when choosing the nozzles, it must be decided whether an energy-efficient process approach is desired or whether the process limit needs to be increased.

In addition to these investigations, other materials such as metal are part of the focus of future work as well as their effect on achievable roughness within the nozzle and the wear resistance in long-term use due to their different material properties. Within the scope of the presented work, only surface grinding has been considered so far. With

the help of the large number of degrees of freedom in 3D-printing, far more complex nozzle geometries and outlet cross-sections can be produced, which is why other grinding processes, such as profile or tool grinding, are to be considered in the future, in order to further utilise the potential of 3D printing for the production of MWF nozzles.

**Acknowledgments.** The research project was carried out in the framework of the industrial collective research programme (IGF no. 20461 N). It was supported by the Federal Ministry for Economic Affairs and Energy (BMWi) through the AiF (German Federation of Industrial Research Association) based on a decision taken by the German Bundestag. The authors express their sincere thanks to AiF, to the German Machine Tool Builders' Association (VDW) and to the collaborating industrial partners for the dedicated support of this research.

## References

1. VDI-Richtlinie 4661: Energiebegriffe und Kennzahlen. Beuth Verlag, Berlin (2003)
2. Gutowski, T., Dahmus, J., Thiriez, A.: Electrical energy requirements for manufacturing processes. In: Proceedings of 13th CIRP International Conference on Life Cycle Engineering, Leuven (2006)
3. Kolkwitz, B.: Einfluss der thermischen Last auf das Arbeitsergebnis und die Energieeffizienz beim Schleifen. Dr.-Ing. Diss. University of Bremen, Shaker (2020)
4. Larek, R.: Ressourceneffiziente Auslegung von fertigungstechnischen Prozessketten durch Simulation und numerische Optimierung. Dr.-Ing. Diss. University of Bremen, Shaker (2012)
5. Karpuschewski, B., Kalhöfer, E., Rief, M.: Energiebilanz einer Zerspanaufgabe. In: VDI-Z integrierte Produktion, VDI-Z integrierte Produktion/Special, vol. 1, pp. 50–51. Springer-VDI-Verl, Düsseldorf (2012)
6. Rief, M., Karpuschewski, B., Kalhöfer, E.: Evaluation and modelling of the energy demand during machining. CIRP J. Manuf. Sci. Technol. **19**, 62–71 (2017)
7. Denkena, B., Reichstein, M., Kramer, N., Jacobsen, J., Jung, M.: Eco- and energy-efficient grinding processes. Key Eng. Mater. **291–292**, 39–44 (2005)
8. Li, W., Winter, M.S., Herrmann, C.: Eco-efficiency of manufacturing processes: a grinding case. Ann. CIRP **61**(1), 59–62 (2012)
9. Heinzl, C., Kolkwitz, B.: The impact of fluid supply on energy efficiency and process performance in grinding. Ann. CIRP **68**(1), 337–340 (2019)
10. Neugebauer, R.: Energy and resources efficiency in the metal cutting industry. In: Seliger, G. (Hrsg.) Advances in Sustainability Manufacturing: Proceedings of the 8th Global Conference on Sustainability Manufacturing. Springer Verlag (2011)
11. Geilert, P.: Hocheffiziente Kühlschmierstoffzufuhr beim Verzahnungsschleifen - Einfluss der Strahlgestalt auf den Prozess. Dr.-Ing. Diss. University of Bremen, Shaker (2020)
12. Rouse, H., Howe, J.W., Metzler, D.E.: Experimental investigation of fire monitors and nozzles. Trans. Am. Soc. Civ. Eng. **77**, 1–29 (1951)
13. Webster, J.A., et al.: Grinding fluid application system design. Ann. CIRP **44**(1), 333–338 (1995)
14. Morgan, M.N., Baines-Jones, V.: On the coherent length of fluid nozzles in grinding. Key Eng. Mater. **404**, 61–67 (2009)
15. Loehrke, R.I., Nagib, H.M.: Control of free-stream turbulence by means of honeycombs: a balance between suppression and generation. J. Fluids Eng. **98**, 342–353 (1976)



16. Szolcek, M., et al.: Effect of thickness to diameter ratio on micro-orifice single-phase liquid flow at low Reynolds number. *Exp. Thermal Fluid Sci.* **97**, 218–222 (2018)
17. Karpuschewski, B.; Bleicher, O.; Beutner, M.: Surface integrity inspection on gears using Barkhausen noise analysis. In: *Proceedings of the 1st CIRP Conference on Surface Integrity (CSI)*, vol. 19, pp. 162–171 (2011)

**Open Access** This chapter is licensed under the terms of the Creative Commons Attribution 4.0 International License (<http://creativecommons.org/licenses/by/4.0/>), which permits use, sharing, adaptation, distribution and reproduction in any medium or format, as long as you give appropriate credit to the original author(s) and the source, provide a link to the Creative Commons license and indicate if changes were made.

The images or other third party material in this chapter are included in the chapter's Creative Commons license, unless indicated otherwise in a credit line to the material. If material is not included in the chapter's Creative Commons license and your intended use is not permitted by statutory regulation or exceeds the permitted use, you will need to obtain permission directly from the copyright holder.





# Model-Based Correlation Analysis of Machine Control Parameters and Process Vibration Amplitudes by the Example of Milling

Shu Ju<sup>(✉)</sup>, Max Reitenspieß, Kai Zhang, and Nico Hanenkamp

Institute of Resource and Energy Efficient Production Systems,  
Friedrich-Alexander-Universität Erlangen-Nürnberg, Bavaria, Germany  
shu.ju@fau.de

<https://www.rep.tf.fau.de/>

**Abstract.** In machining processes, system-immanent process vibrations lead not only to lower surface quality of workpieces but also to the degradation of the machine and tool wear. Effectively minimizing process vibration amplitudes without costly software or hardware add-ons is a research topic that demands further investigation. In this regard, this article focuses on the further development of a holistic milling process model as well as the experimental and simulation-based vibration analysis. The interaction between the nonlinear behaviors of the cascade controlled electric motors and the process parameters are practically evaluated. Moreover, based on the experimental and simulation results, a correlation analysis of the machine control parameters and the process vibration amplitude has been implemented.

**Keywords:** integrated simulation system · machining · process vibration · cascade control

## 1 Introduction

To meet the demands of shorter product life cycles and higher quality requirements, considerable flexibility and dependability in manufacturing are required on an ongoing basis. Furthermore, product complexity and the number of product varieties are increasing as markets and production become more globalized. The use of new manufacturing technologies, as well as their digitization and automation, has become critical in this respect. Using simulation technology, in particular, is becoming increasingly important across the product life cycle. Modeling complex systems, such as machine tools and machining processes, improves production and product development efficiency in terms of both time and cost. Particularly, the need for a trial-and-error process to test a novel approach on actual process and machinery is replaced by simulation. The implementation of more sustainable manufacturing practices can be therefore facilitated.

In this work, a simulation model predicting cutting forces and milling process vibrations has been constructed and experimentally verified in order to analyze

the dynamic behavior of milling processes with varied parameters. The milling process model, when combined with the model of the cascade controlled feed drives, allows for a more comprehensive investigation of the nonlinear dynamics of AC electric motors and the mechanical vibrations of machining processes. Subsequently, a correlation study of the control parameters and the process vibrations has been performed based on the experimental and simulation results.

## 2 State of the Art

First, based on the literature, the current state of research on modeling cutting forces and vibration in machining operations, is briefly presented in this part. Second, various techniques of reducing process vibrations are characterized and compared.

### 2.1 Cutting Forces and Vibration Modeling

Analytical approaches are used to calculate the forces and vibrations generated by the machining operations. The depth of cut in the simulation techniques in [1,2] was calculated by taking into account both the static and dynamic components resulting from the tool geometry and process kinematics, as well as the dynamic vibrations. By converting forces into cutting edge coordinates for turning, drilling, and milling procedures, Kaymakci et al. established a unified cutting force model in [3]. Smith and Tlustý [4] introduced the time marching methods for simulating process states at discrete time periods. The time-discrete estimation of cutting forces for five-axis milling operations was verified by Lazoglu et al. in [5]. In the time-domain simulation system with improved computing time in [6], a model of chip formation of each tooth feed was developed utilizing the CSG (constructive solid geometry) modeling method. For a more comprehensive assessment of virtual systems of machining processes, the reader is directed to the literature [7].

### 2.2 Process Vibration Reducing Techniques

Munoa et al. gave a critical review of the evolution of each approach and the relevant industrial application while demonstrating several chatter reduction strategies in [8]. Modifying the process parameters and the spindle speed based on the stability lobe diagram (SLD) is one technique to reduce chatter. Intensive research on process stability utilizing SLD has been undertaken over the last 15 years, including process damping modeling [9], thin wall machining [10], multi-task operations [11], SLD accuracy enhancement [12], and new ways for monitoring dynamic parameters [13]. Spindle speed variation methods are another effective way for decreasing chatter. These strategies focus on adjusting the tool cutting edge passing period to vary the period between the modulations, as the modulations in chip thickness induce regenerative instability [8].

Despite many methodologies and applications for modeling machining processes, understanding of the relationship between motion control parameters and machining process dynamics remains restricted. Furthermore, minimizing process vibrations and, as a result, optimizing the process outputs without extra costly software or hardware change is a study issue that requires further investigation. In comparison to external software solutions, an independently built simulation model of the machining process with integrated motion control simulation allows for greater flexibility for fundamental scientific research. Moreover, it enables a more thorough assessment of the assigned variables and applied functions. Last but not least, the established model allows for the reproducible investigation of interdependencies between control and process parameters in an enclosed system.

### 3 Milling Process Modeling with Cascade Control

The specifically developed simulation system [14] is used to investigate the influence of control parameter variation on the process vibration amplitudes. The schematic structure of the model is shown in Fig. 1.

The NC-file is initially converted into a matrix consisting of discrete time steps, the set coordinates of the tool path, the spindle speed, the feed rate as well as the logical values for the cutting operation. The motion control model receives the position coordinates as input for the cascade control. Subsequently, with the assistance of the configured PMSM (Permanent-Magnet Synchronous Motor) model and the model of torsional oscillators as the analytical representation of the mechanical elements, the actual position values are calculated and sent to the two dimensional process sub-model. In the process sub-model, the chip thickness is calculated as the distance between the instantaneous cutting edge and the semi-finished workpiece polygon contour at each time step. By subtracting the simulated chip polygon, the workpiece geometry is incrementally updated. Based on the Kienzle formula, the process forces and load torques are calculated and fed back to the PMSM model. The output vibration amplitudes are generated from the mechanics model, which contain the forced vibrations resulted from the periodically varying cutting forces computed in the process sub-model. These are plotted and analyzed for the model validation in Sect. 4.2.

### 4 Experimental Results and Model Validation

In order to verify and validate the simulation model presented in Sect. 3, experimental tests have been carried out at the Institute of Resource and Energy Efficient Production Systems at the Friedrich-Alexander-Universität Erlangen-Nürnberg in Germany. In this section, firstly, the experimental setup of the milling process vibration measurement is specified. Subsequently, the simulation results of the milling process model with different motion control configurations are verified by comparing to the experimental results.

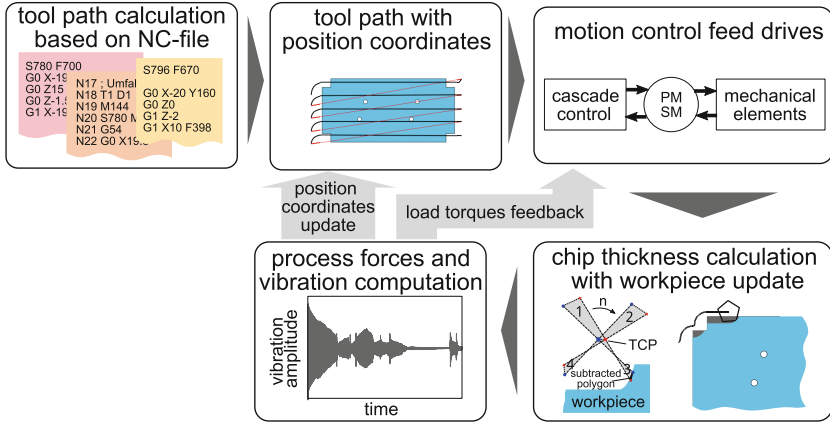


Fig. 1. Schematic structure simulation system

#### 4.1 Experimental Setup

A series of milling operations has been performed in the DNM 500 vertical machining center fabricated by Doosan Machine Tools Co., Ltd. The workpiece clamping setup and its schematic representation are shown in Fig. 2a and Fig. 2b respectively. The workpiece composed of stainless steel X2CrNiMo17-12-2 measures 60 mm in length and width. The milling cutter used is a corner milling cutter from Walter AG, model M4132-040-B16-05-09, with five inserts SDMT09T320-F57 WSP45S. The machine vice is turned 45° clockwise to examine the coordinated motion control of the two feed axes using a predetermined straight milling tool path. The tri-axial acceleration sensor W356B11/NC and the Apollo light measurement system are used to record the vibration amplitudes during the milling process.

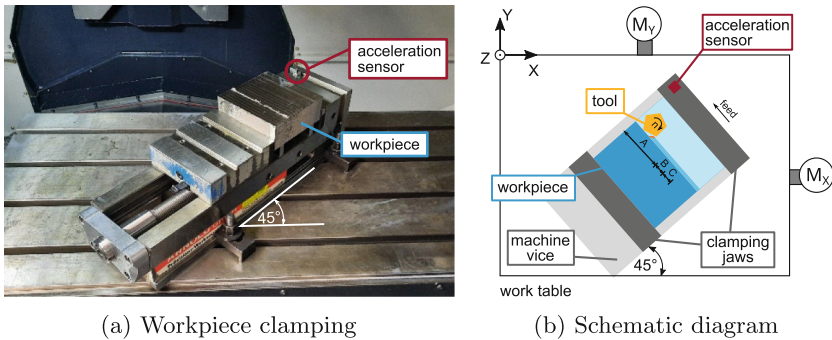


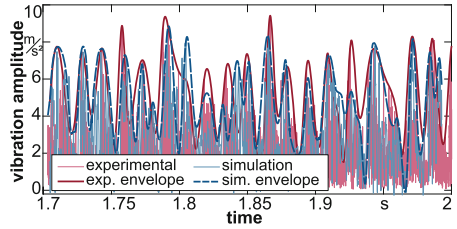
Fig. 2. Experimental setup

## 4.2 Comparison of Experimental and Simulation Results

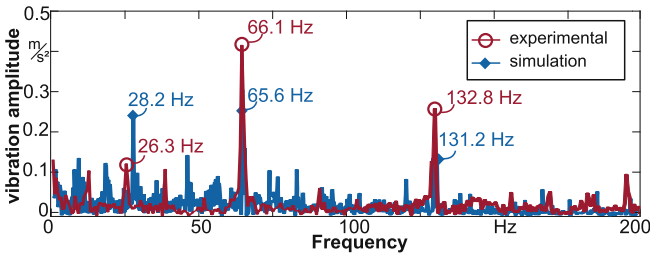
The process parameters selected both in the experimental and simulated milling process are listed in Table 1. In Fig. 3, a 0.3-second section of the time sequence of the vibration amplitudes is extracted for the visualized comparison of the experimental and simulation results. The thick lines in solid red and long-dashed blue represent the envelopes of the vibration signals practically measured and simulated respectively. Using Fast Fourier Transform (FFT), the corresponding spectral analysis of the vibration signals up to 200 Hz is shown in Fig. 4. It can be observed that the simulation result to a great extent agree with the experimental result. The tooth passing frequency, which is proportional to the rotational frequency of the spindle, can be clearly identified in the experimental and simulation signal spectra, at 66.1 Hz and 65.6 Hz respectively.

**Table 1.** Process parameters

Parameter	Value
Feed rate	398 mm/min
Feed per tooth	0.1 mm
Spindle speed	796 rpm
Depth of cut	2 mm
Cutting width	8 mm



**Fig. 3.** Comparison experimental and simulation results



**Fig. 4.** Spectral analysis vibration amplitudes

In order to further verify the plausibility and validity of the motion control sub-model, the process vibration behavior under various position controller configurations has been practically and simulationally evaluated. For each variation of the proportional gain factor  $K_v$ , the root mean square (RMS) of the vibration amplitudes over the complete milling process is calculated and compared (see Fig. 5). Fifteen experimental iterations have been carried out respectively with  $K_v = 6, 11,$  and  $20$ . The corresponding standard deviations are demonstrated

as error bars in the diagram. Based on the reproducibility of the simulation results, the standard deviations of the simulated vibration amplitudes remain zero. The simulation model and the experimental tests yield comparable results with percent errors between 1 to 5%. Both experimental and simulated results indicate that a higher  $K_v$ -value, representing a more dynamic motion control configuration, lead to more active vibration behavior.

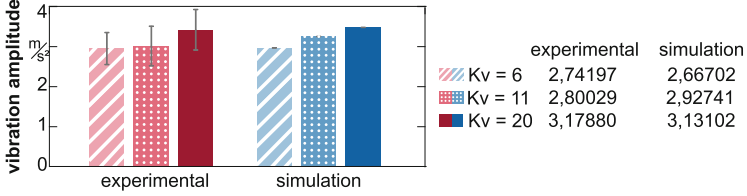


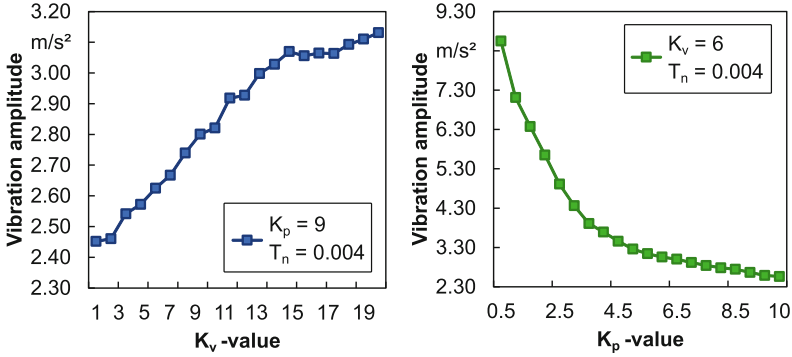
Fig. 5. Comparison RMS with  $K_v = 6, 11, 20$

## 5 Correlation Analysis of Control Parameters and Vibration Amplitudes

In this section, the validated simulation model is implemented to efficiently evaluate the correlational relationship between the motion control parameters and the process vibration behavior. The process parameters utilized for executing the simulation are identical as listed in Table 1. The examined control parameters in this paper are the proportional gain factor of the position controller  $K_v$  and that of the P-part of the speed PI controller  $K_p$ . In the first test series, the  $K_v$ -value has been configured from 1 to 20, with a sampling interval of 1, where the speed controller remains unchanged, with  $K_p = 9$ , and the reset time of the I-part  $T_n = 0.004$ . Analogously, in the second test series,  $K_v$  and  $T_n$  remain constant, with the values of 6 and 0.004 respectively, where the  $K_p$ -value increases from 0.5 to 10, with an interval of 0.5. For each simulated milling process, the RMS of the process vibration amplitudes is calculated. The simulation results of the first and second test series are shown in Fig. 6a and Fig. 6b. It can be observed that both vibration- $K_v$  and vibration- $K_p$  curves are monotonic. To quantify the monotonic correlational relationship between two variables, the Spearman's rank correlation coefficient  $r_s$  is calculated according to Eq. (1)

$$r_s = \frac{\text{cov}(R(X), R(Y))}{\sigma_{R(X)}\sigma_{R(Y)}}, \quad (1)$$

where  $\text{cov}(R(X), R(Y))$  is the covariance of the rank variables  $R(X)$  and  $R(Y)$ ,  $\sigma_{R(X)}$  and  $\sigma_{R(Y)}$  are the standard deviations of the rank variables [15]. The value of  $r_s$  for the variables vibration amplitude and  $K_v$ -factor equals 0.989, demonstrating a very strong positive monotonic correlation. On the other hand,  $r_s$  for vibration amplitude and  $K_p$ -factor indicates a very strong negative monotonic correlation, with the value of  $-1$ .



(a) Vibration amplitude various  $K_v$  (b) Vibration amplitude various  $K_p$

Fig. 6. Simulation results process vibration RMS

## 6 Summary and Outlook

This paper proposes a novel milling process model integrated with motion control simulation with electrical feed drives. The interactions between the nonlinear behaviors of the electrical motors and the milling process vibrations are computationally reproduced. The functionality and the accuracy of the simulation model have been verified by conducting multiple experimental tests. The results demonstrate that the simulation model accurately calculates the tooth passing frequency with a margin of error of less than 1%. The RMS of the process vibration amplitudes features percent errors less than 5%. Moreover, based on the Spearman's correlation method, the correlational relationship between the control parameters,  $K_v$  and  $K_p$ , and the process vibrations is identified as very strong monotonic. The focus of future study will be on the improvement and the extension of the simulation model for a more comprehensive representation of the physical machine tool, especially for the computation of a wide-spectrum and high-resolution spectral analysis of the process vibration signals. A model extension into the third dimension with prediction of the surface finish of the workpiece is inevitable for the computation of the self-excited chatter vibrations. Furthermore, a thorough investigation on the configuration of vibration-reducing control parameters should be carried out.

**Acknowledgment.** This article is part of the work of the Nuremberg Campus of Technology, a research institute funded by the Free State of Bavaria and was established in 2012 as a partnership between Friedrich-Alexander-Universität Erlangen-Nürnberg (FAU) and Technische Hochschule Nürnberg (THN).



## References

1. Altintas, Y., Kilic, Z.M.: Generalized dynamic model of metal cutting operations. *CIRP Ann.* **62**(1), 47–50 (2013). <https://doi.org/10.1016/j.cirp.2013.03.034>
2. Budak, E., Ozlu, E.: Analytical modeling of chatter stability in turning and boring operations: a multi-dimensional approach. *CIRP Ann.* **56**(1), 401–404 (2007). <https://doi.org/10.1016/j.cirp.2007.05.093>
3. Kaymakci, M., Kilic, Z.M., Altintas, Y.: Unified cutting force model for turning, boring, drilling and milling operations. *Int. J. Mach. Tools Manuf.* **54–55**(4B), 34–45 (2012). <https://doi.org/10.1016/j.ijmachtools.2011.12.008>
4. Smith, S., Tlustý, J.: An overview of modeling and simulation of the milling process. *J. Eng. Indust.* **113**(2), 169–175 (1991). <https://doi.org/10.1115/1.2899674>
5. Lazoglu, I., Boz, Y., Erdim, H.: Five-axis milling mechanics for complex free form surfaces. *CIRP Ann.* **60**(1), 117–120 (2011). <https://doi.org/10.1016/j.cirp.2011.03.090>
6. Surmann, T., Biermann, D.: The effect of tool vibrations on the flank surface created by peripheral milling. *CIRP Ann.* **57**(1), 375–378 (2008). <https://doi.org/10.1016/j.cirp.2008.03.059>
7. Altintas, Y., Kersting, P., Biermann, D., Budak, E., Denkena, B., Lazoglu, I.: Virtual process systems for part machining operations. *CIRP Ann.* **63**(2), 585–605 (2014). <https://doi.org/10.1016/j.cirp.2014.05.007>
8. Munoa, J., Beudaert, X., Dombovari, Z., Altintas, Y., Budak, E., Brecher, C., Stepan, G.: Chatter suppression techniques in metal cutting. *CIRP Ann.* **65**(2), 785–808 (2016)
9. Tunc, L.T., Budak, E.: Identification and modeling of process damping in milling. *J. Manuf. Sci. Eng.* **135**(2), (2013)
10. Biermann, D., Kersting, P., Surmann, T.: A general approach to simulating work-piece vibrations during five-axis milling of turbine blades. *CIRP Ann.* **59**(1), 125–128 (2010)
11. Brecher, C., Epple, A., Neus, S., Fey, M.: Optimal process parameters for parallel turning operations on shared cutting surfaces. *Int. J. Mach. Tools Manuf.* **95**, 13–19 (2015)
12. Shamoto, E., Hashimoto, Y., Shinagawa, M., Sencer, B.: Analytical prediction of contact stiffness and friction damping in bolted connection. *CIRP Ann.* **63**(1), 353–356 (2014)
13. Grossi, N., Scippa, A., Sallese, L., Sato, R., Campatelli, G.: Spindle speed ramp-up test: A novel experimental approach for chatter stability detection. *Int. J. Mach. Tools Manuf.* **89**, 221–230 (2015)
14. Ju, S., Gross, D., Hanenkamp, N.: Cutting force and vibration prediction of milling processes regarding the nonlinear behavior of cascade controlled feed drives. *Prod. Eng. Res. Devel.* (2022). <https://doi.org/10.1007/s11740-022-01140-z>
15. Daniel, W.W.: Spearman rank correlation coefficient. In: *Applied Nonparametric Statistics* 2nd edn., pp. 358–365. PWS-Kent, Boston (1990). ISBN 978-0-534-91976-4

**Open Access** This chapter is licensed under the terms of the Creative Commons Attribution 4.0 International License (<http://creativecommons.org/licenses/by/4.0/>), which permits use, sharing, adaptation, distribution and reproduction in any medium or format, as long as you give appropriate credit to the original author(s) and the source, provide a link to the Creative Commons license and indicate if changes were made.

The images or other third party material in this chapter are included in the chapter's Creative Commons license, unless indicated otherwise in a credit line to the material. If material is not included in the chapter's Creative Commons license and your intended use is not permitted by statutory regulation or exceeds the permitted use, you will need to obtain permission directly from the copyright holder.





# A Comparative Sustainability Assessment of Cutting Fluids Usage in Band Sawing

Nithin Rangasamy, Roan Kirwin, and C. S. Rakurty<sup>(✉)</sup>

The M. K. Morse Company, Canton, OH 44708, USA  
rakurtys@mkmorse.com

**Abstract.** Cutting fluids used in machining have received a lot of attention due to their adverse environmental and economic effects. Researchers have studied cutting fluid usage in traditional machining processes such as turning, facing, milling, etc. However, few studies focused on the cutting fluid used in band sawing applications. This study reports a literature review of the usage of the cutting fluid in band sawing and their sustainable and economic aspects. A review of the literature and industrial data has shown that the majority of band saw blades use high-speed steel as the cutting tool material for cutting metal. This study presents a metric-based sustainability assessment and a detailed analysis of recent economic factors such as the cost of the cutting fluids used in band sawing through industrial case studies. A global survey of the cutting fluid usage in the bandsawing application has shown that the majority of the industry is employing flood coolant application. The flood coolant application cost can be as high as 8% of the total consumables cost of the band sawing process.

**Keywords:** Band Sawing · Sustainability · Cutting Fluid

## 1 Introduction

While cutting fluids are a small part of the machining process, they are of particular interest when studying the sustainability of those processes. Cutting fluids may contain components that are harmful to both the environment and workers exposed to them. Mist coolant and lubrication systems can be especially harmful due to their aerosolizing effects. Special care must be taken to select the proper fluid and reduce worker exposure. In terms of sustainable machining processes, another area of interest that is often neglected is waste management. Cutting fluid requires a hazardous waste fluid stream in order for it to be properly disposed. In plants that include other sources of waste fluid, this is not a significant issue. However, many bandsaw users do not have other fluid waste sources beyond small volumes of hydraulic oil. Specialized handling can add significant cost to use and financial incentives for improper disposal.

In traditional machining, cutting fluid has been an active area of study for many years [1, 2]. Researchers have studied sustainable solutions for traditional machining processes such as minimum quantity lubrication [3], targeted cutting fluid application [4–8], and cryogenic application [9]. However, studies investigating cutting fluid in band sawing

have been very limited. Further, band saw cutting fluid sustainability, and economics are almost entirely unexplored. Band sawing differs significantly from traditional processes, making lesson carry over between sawing and traditional machining difficult. Band sawing has a lower depth of cut than traditional machining [10–12]. The combination of small depth of cut, multi-tooth interrupted cutting, and high-speed steel (as tool material) in bandsawing has produced accelerated edge wear. In order to reduce the edge wear, flood coolant is predominately used in the band sawing process irrespective of the workpiece material. MQL (minimum quantity lubricant) mist system are popular in the industry for cutting structural workpieces (I-beam, tubes etc.) as the flood system causes clutter and has potential safety hazards [9]. The mechanics of sawing make sustainability-focused innovations like targeted fluid and through tool coolant difficult or impossible.

## 2 Literature Review

For traditional machining processes such as turning, facing, milling, drilling, grinding, researchers have investigated the effectiveness of the cutting fluid on machining performance metrics such as tool life, surface finish, machining induced surface residual stresses, and economics, etc. [1–3, 13]. In contrast, the overall number of peer-reviewed papers for bandsawing applications is far fewer than traditional manufacturing processes. A review of the published literature is shown in Table 1, shows that the effects of the cutting fluids were not studied until recently. Sawing has a long and storied history stretching back to at least the ancient Egyptians who made hardened bronze saws. Somewhat unexpectedly, sawing of ferrous metals has existed for more than 140 years. Grimshaw, in his 1880 essay on saws, discusses the recommended saw type and conditions for wrought iron and steel beams [14]. Grimshaw discusses the lubrication of saw blades with grease to prevent gumming or buildup of resin when sawing wood. The 1880's literature also discusses the possibility of misted water to cool and lubricate circular saw blades [14]. However, after that, experimental-based studies to find the effectiveness of the cutting fluid while bandsawing have been minimal, as shown in Table 1. In his 1976 report, Taylor showed that using a flow rate of 2 l/min and soluble oil coolant allowed an increase in the production rate of 30% by increasing the feed rate [15]. The same study found that cutting fluid had minimal effect on useable band speeds [15]. Soderberg et.al's 1983 experimental work to cut medium carbon steel, alloy steel, and stainless steel with molybdenum-based steel tool tipped band saw blades, did not study the effect of the cutting fluids [16]. Their study found that sawing speed for bimetal should be tuned to the highest speed where a BUE is still formed to protect the tooth from the heat generated at the primary shear zone [16]. Soderberg et.al's 1986 experimental study to determine tool tip wear mechanism with similar work material and different tool tip material did not consider cutting fluids [17]. Similarly, Doraisingam [18], Khan et. al [19], Sarwar et. al [20], Thaler e. al [21], and Orłowski et. al. [22] experimentally studied the effects of coatings, tool tip material while bandsawing different work piece material without considering the usage of cutting fluid. Other studies that reported usage of the cutting fluid while cutting materials such as Ti-7, Inconel 718, and medium carbon steels, did not evaluate the effect of the cutting fluids [23–26].

**Table 1.** A literature review: experimental-based research in metal band sawing process

First author last name, year	Material being band sawed/cut	Band saw blade tip material	Cutting Fluid (CF) used
Grimshaw, 1880 [14]	Wood, Metal, Bone etc	Steel based tips	Water to cool and lubricate, grease to lubricate
Taylor, 1976 [15]	En44E	M42 tool steel	Soluble oil coolant
Söderberg, 1983 [16]	AISI 1045, AISI 4337, AISI 316	M2 tool steel	Soluble oil with water 1:5
Söderberg, 1986 [17]	AISI 1045, AISI 4337, AISI 316	M2, M35, and M42 tool steels	No mention of CF
Doraisingam, 2003 [18]	Stainless Steels, Tool steels	M42 tool steel	No Mention of CF
Khan, 2009 [19]	Ti-6Al-V	Uncoated carbide tip	No Mention of CF
Sarwar, 2009 [20]	17-7 SS, AISI 52100	M42 tool steel	No Mention of CF
Asilturk, 2009 [27]	AISI 4140	M42 tool steel	Boron oil 20%
Litvinov, 2011 [23]	AISI 1045	M42 tool steel	10% emulsion-based oil
Saglam, 2011 [24]	AISI 1045, AISI 1060, AISI 4140	M42 tool steel	5% emulsion-based semi synthetic
Khan, 2012 [28]	Ti-17	TiAlSiN coated and uncoated carbide	Flood coolant
Thaler, 2014 [21]	St37 (DIN 17100)	M42 tool steel	No Mention of CF
Khan, 2014 [25]	Ti-17	AlTiN Coated and uncoated carbide	Flood coolant
Khan, 2019 [26]	Inconel 718	Single tooth carbide	Flood coolant
Orlowski, 2020 [22]	66Mn4	M71-C, and M42 tool steels	No Mention of CF
Rakurty, 2021 [11]	D2 Steel	Uncoated carbide	Dry, flood coolant, MQL and MQC
Rakurty, 2021 [10]	A36 Steel	M42 tool steel	Dry, flood coolant, MQL and MQC

However, the recent studies by Rakurty et al. have shown that the cutting fluid amount, type, and workpiece geometry effects the performance of the band saw blade [10, 11]. Their study focused on researching the effects of using sustainable solutions in bandsawing solid and structural I-beam sections on tribological parameters such as cutting forces, and cut surface characteristics. Cutting forces, surface roughness, tool wear variations showed little correlation with different types of sustainable conditions. The sustainable conditions studied in their work are dry, Minimum Quantity Coolant

(MQC), Minimum Quantity Lubricant (MQL), and industry-standard flood coolant [7, 8]. Based on the literature review, one can easily conclude that a comprehensive study on the effects of cutting fluids on band sawing is very much needed, and also, more importantly, the effects of the sustainable solution need more attention and research to be effectively used in the industry. One of the first steps in developing sustainable solutions in bandsawing process, an essential manufacturing process, is to review the cutting fluids used in the industry globally and use a metric-based approach to provide state of the art report. A metric-based approach for evaluating the sustainability of manufacturing processes, such as ProcSI, was developed and used in traditional manufacturing processes [2, 29, 30]. The Process Sustainability Index (ProcSI) provides a quantitative assessment for any manufacturing process [31].

Thus, in the study, along with a comprehensive literature review, a global survey is conducted to report state of the art in the industry for evaluating the sustainability impact of the cutting fluids systems used in the band sawing.

### 3 Cutting Fluid Usage Band Sawing: Global Case Studies

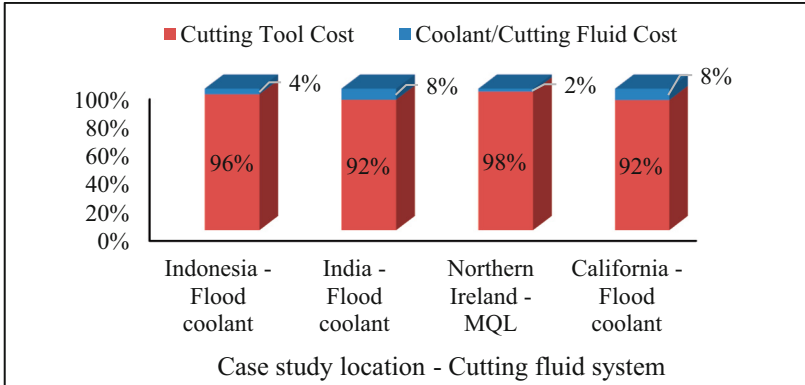
#### 3.1 Economic Analysis

To evaluate the global sustainability impact of cutting fluid used in the bandsawing industry, bandsaw users from four different countries (Indonesia, India, Northern Ireland, and the USA) were chosen. The case studies from Indonesia, India, and the USA (California) use flood coolant to cut both solids and structural cross-sections, whereas, in Northern Ireland, they use MQL system to cut structural material. In the band sawing industry, typically, the flood coolant system uses a water-soluble cutting fluid mixed at a specific ratio with water, whereas the MQL system uses unmixed oil (no water). For the sake of brevity, in this survey, machine cost, workpiece geometry variation, cutting tool type, and the conditions are not considered. All the data from this section of the study is from the end users of The M. K. Morse Company. The saw blade [32] end users provided the information such as coolant type, quantity, frequency of recycling, method of recycling, etc., per year. Also, provided the time required to maintain the cutting fluid system and saw blade life, usage per year. Using the information provided by the saw blade users, the following case studies are evaluated.

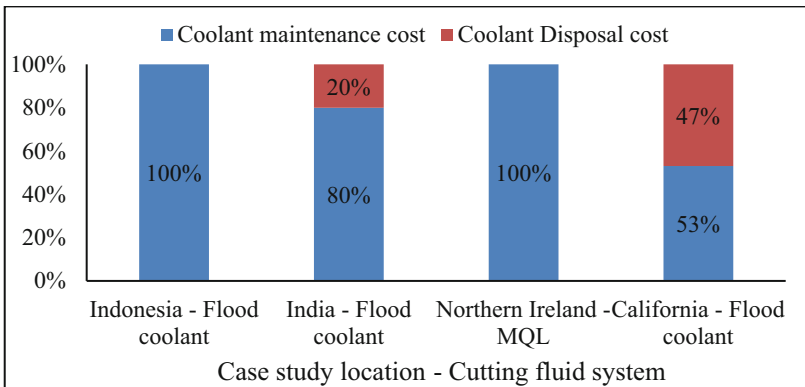
Typically, in the bandsaw industry, cutting fluid costs are not considered when a job's manufacturing cost is evaluated/estimated. In this paper, the economic impact of cutting fluid in bandsaw industries is evaluated by comparing it to the cutting tool cost. This study evaluates both direct and indirect costs associated with using cutting fluids and also cutting tools. The average annual cutting fluid (direct and indirect cost) and average annual cutting tool cost for the financial year 2020–2021 were collected as part of the survey for all four case studies. Figure 1 shows the manufacturing cost as a percentage of cutting tool cost and cutting fluid cost for all four case studies. As expected, the cutting tool cost was over 90% of the total cost (cutting tool and cutting fluid) for all four cases. It is interesting to note that cutting fluid costs were 8% of the total cost for the flood coolant users in India and California, whereas MQL user in Northern Ireland was just 2%. This difference is attributed to the economic benefits of using the MQL system. MQL system typically uses 30–300ml/hr. of cutting fluid, whereas flood uses 4–6l/hr.

of cutting fluid. Further, MQL system users do not have any disposal/recycling costs associated with it.

Despite using flood coolant, the cutting fluid cost is only 4% of the total cost for the case study in Indonesia. On further investigation, it was found that the user in Indonesia does not recycle/dispose of their cutting fluid and hence does not have any cost associated with it. Figure 2 shows the cutting fluid cost as a percentage of maintenance cost and disposal cost. Cutting fluid maintenance costs includes cutting fluid costs, labor cost associated with coolant maintenance, and water cost (applies to flood only).



**Fig. 1.** Manufacturing cost as a percentage of cutting tool cost and cutting fluid cost



**Fig. 2.** Total cutting fluid cost as a percentage of maintenance cost and disposal cost

### 3.2 Sustainability Index (SI) Evaluation

An initial attempt was made to adapt the ProcSI technique to the bandsawing process to evaluate the sustainability index of the flood coolant and MQL systems used

predominantly in the industry. The ProcSI consists of five major categories: manufacturing cost, energy consumption, waste management, environmental impact, and personal health. The only quantitative analysis that could be effectively performed with these case studies is the cost associated with cutting fluid. The manufacturing cost category was evaluated using the direct and indirect costs associated with the cutting fluid. The other factors/categories in the ProcSI were evaluated using a sustainability scale developed by Tao Lu [29]. A score close to zero is theoretically a worst-case scenario, while a ten is a best-case scenario. Also, a score of four meets the minimum requirement, while six is above average status [29]. These factors are scored relatively by comparing the differences between the flood coolant and the MQL systems. Table 2 shows the ProcSI evaluation of cutting fluid application/usage for both systems. In general, bandsaw blade users are not using changing or monitoring the cutting fluid for productivity or cutting performance; thus, an attempt is made to approach a metric-based study to alter the approach of bandsaw blade users.

**Table 2.** ProcSI evaluation for flood coolant and MQL systems [29]

Category	Sub-category	Flood coolant	MQL
Manufacturing cost	Direct & Indirect cost (cutting fluid)	4	6
Energy Consumption	Production	5	5
	Transportation	4	7
	Maintenance	4	5
Waste management	Consumables: cutting fluid & water	4	7
Environment Impact	water	4	8
	disposed waste	5	8
Personal Health	Working environment conditions	5	4
Overall ProcSI		<b>4.4</b>	<b>6.3</b>

Production, transportation, and maintenance are the sub-categories considered under energy consumption. The flood coolant system uses a filtration system and a motor to circulate the coolant, while the MQL system uses compressed air and a motor to deliver the mist at the cutting edge. The maintenance of the MQL system is relatively more straightforward than the flood system due to the lower volume and no water consumption. Further, frequent recharge/ replenishment of the coolant is necessary for flood coolant systems due to water evaporation and coolant losses with the workpiece. The coolant disposal in the flood coolant system is another burden for manufacturers, causing further financial impact and contributing to waste generation.

In contrast, the MQL system generally uses biodegradable vegetable oils. The aerosol effects of the MQL system may cause concern for personal health, whereas the flood coolant system generates hazardous waste fluid. For simplicity, the overall ProcSI is calculated by equally weighing all the sub-categories considered in this study. There is a



clear difference between the flood and MQL systems, further validating the importance of understanding the effects of different cutting fluid systems.

## 4 Conclusions

The literature review highlighted that cutting fluid effects in bandsawing are seldom studied and need more attention from both academic and industry research. Further study could potentially reduce the usage of the cutting fluid and improve the band saw blade life, thereby increasing the sustainability of the band sawing process. A global survey of the cutting fluid usage in the band sawing application has shown that the majority of the industry is employing flood coolant application with flow rate of more than 4–6 l/min. The flood coolant application cost can be as high as 8% of the total consumables (cutting fluid and cutting tool) cost of the band sawing process. An initial attempt at evaluating the flood coolant application and MQL using ProcSI, a metric-based sustainable index, has shown that a sustainable solution such as MQL can be economic, environmental, and energy-friendly. Future research is recommended to assess ProcSI metrics for other sustainable solutions such as MQC and dry along with their industrial applicability.

## References

1. Jawahir, I.S., Schoop, J., Kaynak, Y., Balaji, A.K., Ghosh, R., Lu, T.: Progress toward modeling and optimization of sustainable machining processes. *J. Manuf. Sci. Eng.* **142**(11), 110811 (2020)
2. Jayal, A.D., Badurdeen, F., Dillon, O.W., Jawahir, I.S.: Sustainable manufacturing: modeling and optimization challenges at the product, process and system levels. *CIRP J. Manuf. Sci. Technol.* **2**(3), 144–152 (2010)
3. Wanigarathne, P.C., Liew, J., Wang, X., Dillon Jr., O.W., Jawahir, I.S.: Assessment of process sustainability for product manufacture in machine operations. In: *Proceedings of the Global Conference on Sustainable Product Development and Life Cycle Engineering*, Berlin, Germany, pp. 305–312 (2004)
4. Rangasamy, N., Balaji, A.K.: microstructural characterization of sub-surface deformation in machined Ti6Al4V under varying cutting fluid application. *Mater. Sci. Technol. Conf. Exhib.* **2**, 1165–1171 (2016)
5. Rakurty, C.S.: Targeted and variable minimum quantity cutting fluid application for finish machining of steels. Ph.D. dissertation, The University of Utah (2019). [ark:/87278/s6vq93x8](https://doi.org/10.1016/j.procir.2022.03.122)
6. Rangasamy, N., Rakurty, C.S., Balaji, A.K.: A multiscale study on machining induced surface integrity in Ti-6Al-4V alloy. *Procedia CIRP* **108**, 787–792 (2022). <https://doi.org/10.1016/j.procir.2022.03.122>
7. Balaji, A.K., Rakurty, C.S., Montemayor, H., Ghatikar, V.: A novel multiple cutting fluid dispensing system for sustainable manufacturing. In: *STLE Annual Meeting & Exhibition*, Florida, USA, pp. 18–22 (2014)
8. Rakurty, C.S., Rangasamy, N., Balaji, A.K., Swapnil, P.: A finite element analysis based approach to understand the effects of targeted minimum quantity cutting fluid application on surface integrity. *Procedia CIRP* **108**, 613–618 (2022). <https://doi.org/10.1016/j.procir.2022.03.097>
9. Umbrello, D., et al.: The effects of cryogenic cooling on surface integrity in hard machining. *Procedia Eng.* **19**, 371–376 (2011)

10. Rakurty, C.S., Rangasamy, N.: An experimental study on sustainable bandsawing solutions for structural application. In: Proceedings of the ASME 2021 IMECE, Volume 2B: Advanced Manufacturing. Virtual, Online, 1–5 November, p. V02BT02A066 (2021). <https://doi.org/10.1115/IMECE2021-73133>
11. Rakurty, C.S., Rangasamy, N.: Cutting fluid application for bandsawing: a sustainable solution for cutting solids. In: Proceedings of the ASME 2021 IMECE. Volume 2B: Advanced Manufacturing. Virtual, Online., p. V02BT02A065 (2021). <https://doi.org/10.1115/IMECE2021-73127>
12. Rangasamy, N., Rakurty, C.S., Maurer, Z.: Minimum quantity cutting fluid application for grinding weld flash : surface integrity evaluation. *ASME OPEN J. Eng.* **1**, 014503 (2022). <https://doi.org/10.1115/1.4054948>
13. Rangasamy, N., Rakurty, C.S.: Effects of cutting fluid applications on surface integrity in grinding of weld flash in resistance welded alloy steel. In: Proceedings of the ASME 2021 IMECE. Volume 2B: Advanced Manufacturing. Virtual, Online. 1–5 November, p. V02BT02A058 (2021). <https://doi.org/10.1115/IMECE2021-69807>
14. Grimshaw, R., Saws, E.: Claxton & Co., Philadelphia, PA (1880)
15. Taylor, R.W.: An investigation into the wear characteristics of bandsaw blades and their influence on the sawing rates and costs of bandsaw operations. Sheffield City Polytechnic (1976)
16. Söderberg, S., Åhman, L., Svenzon, M.: A metallurgical study of the wear of band-saw blades. *Wear* **85**(1), 11–27 (1983)
17. Söderberg, S., Hogmark, S.: Wear mechanisms and tool life of high speed steels related to microstructure. *Wear* **110**(3–4), 315–329 (1986)
18. Doraisingam, A.R.: Simulation of the intermittent cutting action of a bandsaw blade. Ph.D. dissertation, Northumbria University (2003)
19. Khan, F.N., Sarwar, M., Persson, M.: Cutting energy and wear in bandsawing operation when cutting Ti-6Al-4V alloy. *Int. Conf. Flex. Autom. Intell. Manuf.*, 865–872 (2009)
20. Sarwar, M., Persson, M., Hellbergh, H., Haider, J.: Measurement of specific cutting energy for evaluating the efficiency of bandsawing different workpiece materials. *Int. J. Mach. Tools Manuf.* **49**(12–13), 958–965 (2009)
21. Thaler, T., Potočník, P., Kopač, J., Govekar, E.: Experimental chatter characterization in metal band sawing. *J. Mech. Eng.* **60**(4), 265–273 (2014)
22. Orłowski, K.A., Dobrzynski, M., Gajowiec, G., Lackowski, M., Ochrymiuk, T.: A critical reanalysis of uncontrollable washboarding phenomenon in metal band sawing. *Materials (Basel)* **13**(20), 1–10 (2020)
23. Litvinov, A.E., Kornienko, V.G., Sukhonosov, N.I.: Cutting by means of band saws. *Russ. Eng. Res.* **31**(1), 59–61 (2011)
24. Saglam, H.: Tool wear monitoring in bandsawing using neural networks and Taguchi's design of experiments. *Int. J. Adv. Manuf. Technol.* **55**(9–12), 969–982 (2011)
25. Khan, F.N., Daadbin, A., Persson, M., Haider, J.: Development of AlTiN coated carbide bandsaw for machining Titanium-17 alloy. *Int. J. Surf. Sci. Eng.* **8**(1), 11–27 (2104)
26. Khan, F.N., Haider, J., Persson, M.: Investigating tool performance and wear when simulating bandsawing of nickel-based superalloy under interrupted orthogonal turning condition. *Proc. Inst. Mech. Eng. Part B J. Eng. Manuf.* **233**(2), 515–526 (2019)
27. Asiltürk, I., Ünüvar, A.: Intelligent adaptive control and monitoring of band sawing using a neural-fuzzy system. *J. Mater. Process. Technol.* **209**(5), 2302–2313 (2009)
28. Khan, F.N., Daadbin, A., Persson, M., Haider, J., Hellbergh, H.: Assessing the performance of TiAlSiN coating on bandsaw tooth when cutting Ti-17 alloy. *Proc. Inst. Mech. Eng. Part B J. Eng. Manuf.* **226**(5), 870–877 (2012)
29. Lu, T.: A metrics-based sustainability assessment of cryogenic machining using modeling and optimization of process performance. Ph.D. dissertation, University of Kentucky (2014)

30. Bilge, P., Badurdeen, F., Seliger, G., Jawahir, I.S.: A novel manufacturing architecture for sustainable value creation. *CIRP Ann. Manuf. Technol.* **65**(1), 455–458 (2016)
31. Lu, T., Jawahir, I.S.: Metrics-based sustainability evaluation of cryogenic machining. *Procedia CIRP* **29**, 520–525 (2015)
32. Rakurty, C.S., Vandervaart, P.C.: Ground set saw blade. US Patent 10279408 (2019)

**Open Access** This chapter is licensed under the terms of the Creative Commons Attribution 4.0 International License (<http://creativecommons.org/licenses/by/4.0/>), which permits use, sharing, adaptation, distribution and reproduction in any medium or format, as long as you give appropriate credit to the original author(s) and the source, provide a link to the Creative Commons license and indicate if changes were made.

The images or other third party material in this chapter are included in the chapter's Creative Commons license, unless indicated otherwise in a credit line to the material. If material is not included in the chapter's Creative Commons license and your intended use is not permitted by statutory regulation or exceeds the permitted use, you will need to obtain permission directly from the copyright holder.





# Design and Characterization of Piezoceramic Thick Film Sensor for Measuring Cutting Forces in Turning Processes

M. Panesso<sup>1</sup>(✉), M. Ettrichrätz<sup>1</sup>, S. Gebhardt<sup>2</sup>, O. Georgi<sup>1</sup>, C. Rüger<sup>1</sup>, M. Gnauck<sup>1</sup>, and W.-G. Drossel<sup>1</sup>

<sup>1</sup> Fraunhofer IWU, Fraunhofer Institute for Machine Tools and Forming Technology, Nöthnitzer Str. 44, 01187 Dresden, Germany

miguel.antonio.panesso.perez@iwu.fraunhofer.de

<sup>2</sup> Fraunhofer IKTS, Fraunhofer Institute for Ceramic Technologies and Systems, Winterbergstr. 28, 01277 Dresden, Germany

**Abstract.** Cutting forces in turning processes usually correlate with tool conditions. For this reason, the acquisition of force signals is of key importance for monitoring purposes. Despite the robustness of current piezoelectric measuring platforms, their large weight ratio relative to standalone tool-holder systems limits their effective usable bandwidth for analyzing force signals. Further limitations include high costs and lack of flexibility for general purpose turning operations. Due to this, such systems fail to find acceptance in practical applications and are mainly limited to research activities. To improve these aspects, this work investigates the use of an alternative integration concept using a piezoceramic thick film sensor for performing near-process cutting force measurements at the tool-holder. The charge output of the sensor was estimated using a coupled structural-piezoelectric simulation for its design. The modelled prototype was assembled and characterized by means of a static calibration and an impact hammer test. Following these, a first implementation of the system under dry cutting conditions took place.

**Keywords:** piezoceramic thick film sensor · lead zirconate titanate (PZT) · cutting force

## 1 Introduction

Cutting forces in machining operations have been studied extensively due to their sensitivity to changes in process states [1]. They have been further used mainly in research activities as input for process optimization, and for monitoring tool wear [2]. The static and dynamic components of force signals are used in the latter case, because the low frequency amplitudes and certain components at higher frequencies increase with higher friction between tool and workpiece when wear is present [3]. Monitoring turning processes is of key relevance for optimizing tool life and reducing workpiece waste by predicting tool breakage, thus optimizing resource use and output quality of the workpiece. This contributes positively to increasing sustainability in turning processes.

© The Author(s) 2023

H. Kohl et al. (Eds.): GCSM 2022, LNME, pp. 30–39, 2023.

[https://doi.org/10.1007/978-3-031-28839-5\\_4](https://doi.org/10.1007/978-3-031-28839-5_4)

For measuring forces and torques in manufacturing technology, piezoelectric sensors, strain gauges, and, occasionally, inductive and capacitive position transducers are utilized [4]. Piezoelectric based plate dynamometers are usually preferred due to their high stiffness and good static properties, such as good linearity and negligible crosstalk [2]. Commercial plate dynamometers, for example the models 9121 or 9119A from Kistler, have been used in several research works in the field of machining process monitoring [5]. A drawback of such systems resides in their relatively limited usable frequency bandwidth before attaining resonance at 0.7 - 1 kHz, caused by their relatively high mass compared to the standard tool-holders (mass ratio of 3:1) [6]. A further limitation for practical applications relates to the high cost of the system.

Some approaches in the literature dealt with the issues of improving integrability, reducing system mass, and improving the usable bandwidth. Klocke et al. [6] proposed a modular sensor concept for integration in a rotating tool-holder for face-milling. The individual sensor modules were tested in a lathe turret and compared with a reference plate dynamometer by performing static and dynamic measurements with the help of an impact hammer. The dynamic limit of the proposed sensor system of 2.1 kHz was obtained by means of a dynamic test under ideal conditions and a value of 1.7 kHz was established under real cutting conditions. This showed an improvement in contrast to the transfer function of a plate dynamometer, which achieved a first resonance peak at approximately 1 kHz. Similar results are presented by Totis et al. in [2, 5].

Drossel et al. [7] proposed a novel concept for measuring cutting forces in milling applications and in the direct vicinity of the indexable insert. The sensor concept consisted of a carbide plate coated with a piezoceramic thick film sensor layer of lead zirconate titanate (PZT), which was mounted behind the tool insert [7]. The high quality of the measured signals was compared to that of signals obtained with a conventional dynamometer, showing the high potential of the approach for improving the integrability of this type of sensors in machine tools, by reducing the required mounting space and the influence on the tool-holder rigidity and mass properties.

This work further investigates the integration of piezoceramic thick film sensors for measuring cutting forces in turning processes. The previous implementation proposed by Drossel et al. was done for milling operations, which focused on the dynamic characteristic of the force signals. The novelty of this work consists in qualifying the sensor-technology for also measuring the quasistatic component of the cutting force signals. The following objectives were pursued: (1) to estimate the performance of the sensor at the integration location in the tool-holder by means of a static structural-piezoelectric coupled simulation, (2) to fabricate and assemble the designed sensor geometry in the tool-holder system and to characterize its static and dynamic properties, (3) to perform cutting tests in turning operations and compare the acquired force signals to those of a reference dynamometer, and (4), to conclude on the performance of the sensing approach and relevant aspects for optimizing the design. The results of this work cover a first step towards qualifying the sensor for quasistatic force measurements. Future work includes extending the sensing principle to a continuous monitoring scenario with the aim of optimizing turning processes in the context of sustainable manufacturing.

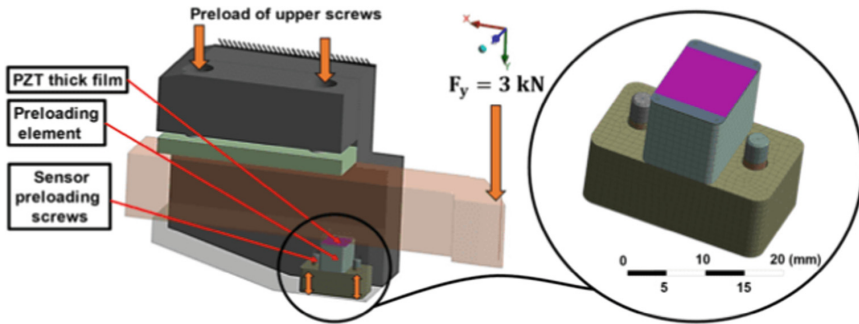
## 2 Sensor Design and Simulation

Piezoelectric materials have the property of converting mechanical energy to electrical energy. This occurs by generating an electric polarization (charge) proportionally to the application of a mechanical stress, and it is a natural property of some single crystals like quartz, ferroelectric ceramics (e.g. PZT), and piezoelectric polymers [8]. Models used for simulating the direct piezoelectric effect are defined by coupling the structural and electrical fields occurring in the material. For static analysis relating the output voltage to a given constant strain, piezoelectric materials are modelled considering their structural elasticity, piezoelectric coupling, and dielectric permittivity as follows [8]:

$$\begin{aligned} \{T\} &= [c]\{S\} - [e]\{E\} \\ \{D\} &= [e]^T\{S\} + [\epsilon]\{E\} \end{aligned} \quad (1)$$

In (1),  $\{T\}$ ,  $\{S\}$ ,  $\{D\}$ ,  $\{E\}$ , are the stress, elastic strain, electric flux density, and electric field intensity vectors. The matrixes  $[c]$ ,  $[e]$ ,  $[\epsilon]$  represent the elastic stiffness, the piezoelectric coupling, and the dielectric permittivity respectively.

The previous formulation was implemented in ANSYS-Workbench in order to simulate the charge output of a rectangular PZT thick film sensor geometry with an area of  $10 \times 10 \text{ mm}^2$  and a layer thickness of  $40 \mu\text{m}$ . The sensor geometry and its location between the tool-holder and the tool-holder receptacle is shown in Fig. 1.



**Fig. 1.** Geometry of PZT thick film sensor integration concept and conditions of static model.

The preferred location of the sensor was qualitatively determined under the criteria of smallest possible distance to the cutting insert in the force transmission path while concurrently maximizing protection against external particles and coolant. The location was also estimated as less susceptible to temperature effects compared to directly below the cutting insert, where the temperature increase is more significant. Further, the attachment of the sensor was simulated by fastening a preloading element.

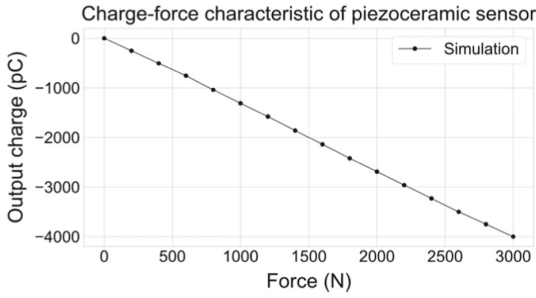
The static simulation was performed in three steps, corresponding to the application of a 20 kN preload on the upper screws to secure the tool-holder, followed by the application of a 0.5 kN preload on each screw at the preloading element, and a last step corresponding to a vertical force at the tool tip of 3 kN. To complete the definition of the boundary conditions, the receptacle of the tool-holder was fixed in all degrees of freedom, and all contacts between components defined as frictional.

The coupled structural-piezoelectric behavior of the sensor was modelled using elements of the type PLANE226 in ANSYS. For the simulation, the material properties of the PZT thick film material IKTS-PZ 5100 used for the sensor have been applied [9]. The PZT thick film is defined as orthotropic, and the elastic stiffness matrix [c] and coupling piezoelectric matrix [e] are defined as follows:

$$[c] = \begin{bmatrix} c_{11} & c_{12} & c_{13} & c_{14} & c_{15} & c_{16} \\ c_{12} & c_{22} & c_{23} & c_{24} & c_{25} & c_{26} \\ c_{13} & c_{23} & c_{33} & c_{34} & c_{35} & c_{36} \\ c_{14} & c_{24} & c_{34} & c_{44} & c_{45} & c_{46} \\ c_{15} & c_{25} & c_{35} & c_{45} & c_{55} & c_{56} \\ c_{16} & c_{26} & c_{36} & c_{46} & c_{56} & c_{66} \end{bmatrix} = \begin{bmatrix} 12.71 & 7.86 & 7.87 & 0 & 0 & 0 \\ 7.86 & 12.71 & 7.87 & 0 & 0 & 0 \\ 7.87 & 7.87 & 11.11 & 0 & 0 & 0 \\ 0 & 0 & 0 & 2.92 & 0 & 0 \\ 0 & 0 & 0 & 0 & 2.92 & 0 \\ 0 & 0 & 0 & 0 & 0 & 2.42 \end{bmatrix} \cdot 10^{10} \text{ Nm}^{-2}$$

$$[e] = \begin{bmatrix} e_{11} & e_{12} & e_{13} \\ e_{21} & e_{22} & e_{23} \\ e_{31} & e_{32} & e_{33} \\ e_{41} & e_{42} & e_{43} \\ e_{51} & e_{52} & e_{53} \\ e_{61} & e_{62} & e_{63} \end{bmatrix} = \begin{bmatrix} 0 & 0 & -1.7 \\ 0 & 0 & -1.7 \\ 0 & 0 & -16.0 \\ 0 & 11.3 & 0 \\ 11.3 & 0 & 0 \\ 0 & 0 & 0 \end{bmatrix} \cdot \text{Cm}^{-2}$$

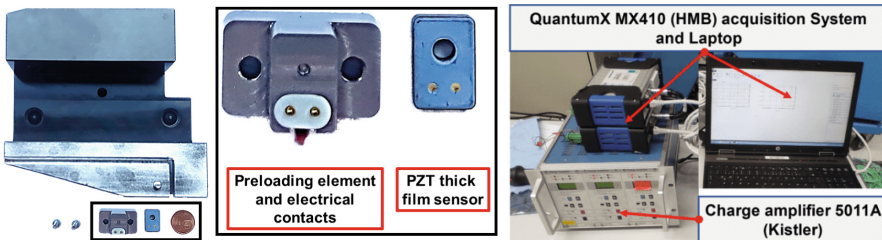
To complete the formulation, the dielectric permittivity constants (in F/m)  $\epsilon_0 = 8.85 \cdot 10^{-12}$ ,  $\epsilon_{s1}$  and  $\epsilon_{s2} = 1320 \cdot 10^{-12}$ , and  $\epsilon_{s3} = 1475 \cdot 10^{-12}$  are included. All other components, including the substrate of the sensor, were modelled as steel with an elastic modulus of 200 GPa and a Poisson's ratio of 0.3. The charge output in pC of the model is presented in Fig. 2. The linear behavior suggests a favorable location of the sensor for measuring the cutting force in the 0–3 kN range. An additional criterion for the design consists in not exceeding the depolarization stress of the material of 50 MPa, and which was verified with a simulated maximum value of 26 MPa. Given these results, the sensor design was determined to be suitable for fabrication and testing. The estimated charge output is further used as guideline for selecting the range of the charge amplifier for the characterization of Sect. 3.



**Fig. 2.** Simulated charge output of piezo ceramic thick film sensor.

### 3 Characterization

Following the simulation, the PZT thick film sensor was fabricated by means of a screen-printing process applied on a substrate of a specially heat-treated steel alloy of the reference 1.4016. The sensor and the adapted geometry of the tool-holder are displayed in Fig. 3(left). The layer set-up comprised a successively printed sequence of dielectric insulation, bottom Au electrode, PZT thick film based on IKTS-PZ 5100 material, top Au electrode, and passivation layer. The layers were sintered at 850°C for 10 min with a total firing cycle time of 60 min. The PZT thick film was built up by repeated screen-printing in the green state to reach a sintered thickness of 40  $\mu\text{m}$ . A polymer-based passivation layer has been printed on top to protect sensor from environmental influences such as cooling lubricants and chips. It has been cured after printing at 150°C for 60 min. The following thicknesses were achieved in the sintered/cured state: (1) dielectric insulation:  $t \sim 25 \mu\text{m}$ , (2) Au bottom electrode:  $t \sim 10 \mu\text{m}$ , (3) PZT thick film:  $t \sim 40 \mu\text{m}$ , (4) Au top electrode:  $t \sim 10 \mu\text{m}$ , (5) Passivation layer:  $t \sim 15 \mu\text{m}$ .



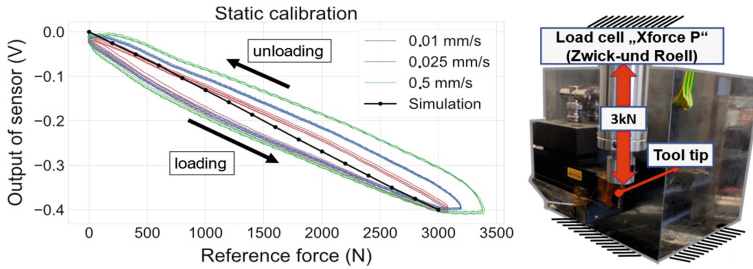
**Fig. 3.** Integration of sensor in tool holder (left) and set up for data collection (right).

#### 3.1 Static Calibration

The assembled prototype was calibrated using a “Zwick-und Roell” universal testing machine with an integrated load cell of the type “Xforce P” (precision class 1 according to ISO 7500). The load cell provided a measuring range of up to 20 kN, a resolution of



$< 0.5\%$ , and a repeatability  $< 1\%$ . For the calibration, a compression load of up to 3 kN was applied at the tip of the tool-holder by means of an axial transmission rod directly connected to the load cell of the machine. For acquiring the output voltage signal of the sensor, a charge amplifier type 5011A from Kistler and a QuantumX MX410 acquisition system from HBM was used (Fig. 3, right). The test was performed using three different rates of application of the force. For each of these, five loading and unloading cycles were performed. The results are presented in Fig. 4.



**Fig. 4.** Force at the tool tip and voltage output of sensor (left) and static calibration (right).

The calibration revealed a significant frequency dependent hysteresis of the signal output, which is consistent with the known behavior of ferroelectric ceramics [8]. For a first implementation, only the loading portion was used for calibrating the sensor, assuming a constant slope. As a last remark it should be noted that the simplified static simulation model of Sect. 2 fits reasonably well within the measuring range of the output signals, with the conversion from pC to V being performed by using the conversion factor of the charge amplifier.

### 3.2 Dynamic Characterization

The vibrational response of the measuring system was further investigated by exciting it with an impact hammer to estimate its frequency response function *FRF* [10]. An idealized test set-up was built by attaching the tool system to a steel block, with a mass ratio of 10:1. The first eigenfrequency of the steel-block using this 10-factor criterion was estimated at 8 kHz, which was above the expected eigenfrequency of the tool-holder in the range of 2–3 kHz. To verify this, measurements were performed by using an impact hammer PCB 086C03 combined with an accelerometer Dytran 3273M2. By positioning the accelerometer at one corner of the steel block and below the cutting-insert, two groups of measurements were recorded by exciting both the steel block and the tool holder separately, as shown in Fig. 5(left). Using the outputs of the accelerometer and the impulse hammer, the FRF-parameter accelerance  $A(\omega)$  is defined as the quotient of the acceleration and force responses (Fig. 5, center) [10]. In the majority of the frequency range up to 7.5 kHz the blocks accelerance is ten times lower than that of the measuring system. Also, the isolated block lies above 7.5 kHz, while the first eigenfrequency of the measuring system is around 2.4 kHz. This value of 2.4 kHz is also obtained after

calculating the force transfer function between the output signal of the measuring system and that of the impulse hammer (Fig. 5, right). The result is consistent with the results presented in [2, 6], thus reflecting a potential improvement of the effective bandwidth by roughly a factor two compared to plate-dynamometers.

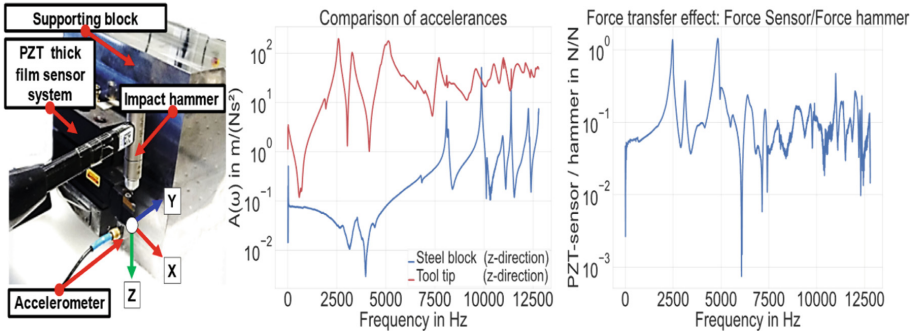


Fig. 5. Impact hammer test set-up (left), comparison of acceleration of supporting block and tool-holder (center), and force transfer function of measuring system (right).

### 4 Cutting Tests

Outer diameter step turning operations were performed both with the developed sensor system and with a reference plate dynamometer 9129AA from Kistler. A 40CrMnMoS8-6 steel bar was machined (dry conditions) using a cutting depth of 1 mm, a feed of 0.3 mm/rev, and a cutting speed of 150 m/min. The force signals were acquired using the same settings of the charge amplifier of the static calibration and a sampling rate of 4.8 kHz. Details of the setup are shown in Fig. 6.

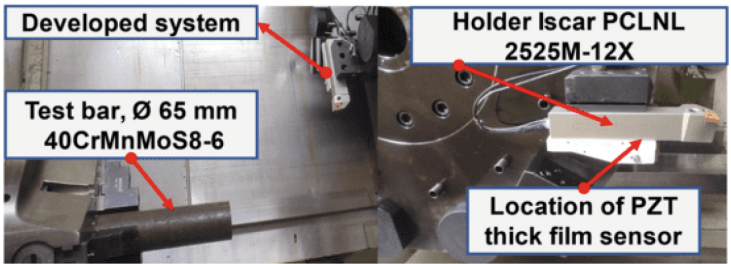
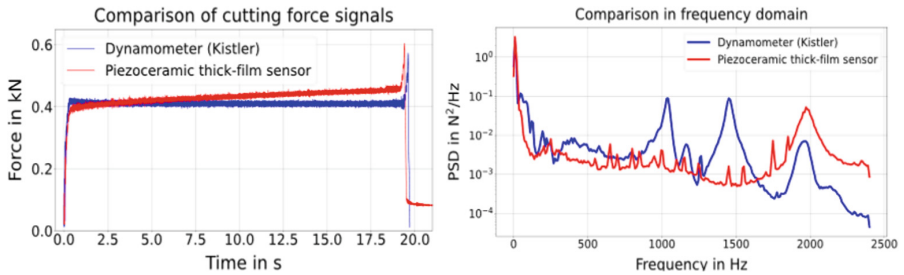


Fig. 6. Set-up of developed system in turning test under dry conditions.

The result of the cutting test in the time domain is presented in Fig. 7(left). The cutting force signal of the reference dynamometer (blue line) remains constant as expected for constant cutting parameters. The red curve of the developed system shows in contrast a constant positive drift, which is due to the thermal sensitivity of the sensor at the

measuring location. Two aspects contribute to this: (1) the slight change of the piezoelectric properties of the PZT sensor in dependence of the temperature, and (2) a thermally induced mechanical load on the sensor caused by the linear expansion of the components with increasing temperature. This last assertion is supported by the documentation of the reference dynamometer, which makes mention of previous models facing this thermal effect at a similar sensor location and preload method. Future tests must include a temperature measurement at the location of the sensor and performing tests with coolant. It should be thus determined if a temperature compensation is necessary even after using coolant. Despite the differences of the signals of the new and reference systems, the feasibility of using PZT thick film sensors for measuring quasistatic cutting forces and the potential for improvement was first demonstrated.



**Fig. 7.** Cutting force signals in time domain (left) and comparison of spectral power densities (PSD) of signals (right), obtained from PZT thick film sensor and reference dynamometer (Color figure online).

The performance of both systems in the frequency domain is compared in Fig. 7 (right) by means of a power density spectrum. A first major peak on the signal of the PZT thick film sensor (red line) is observed at around 2 kHz, roughly corresponding to the 2.4 kHz resonance frequency of the ideally supported setup for the impact hammer test of Sect. 3. The first major peak on the case of the reference dynamometer occurs at around 1 kHz. The analysis on the frequency domain might suggest an effective usable bandwidth of the system based on the PZT thick film sensor twice as large as that of the reference dynamometer, with an additional impact hammer test with the dynamometer in order to confirm the result. The plausibility of this assertion is supported by similar literature results as presented in [2, 5, 6]. At last, an estimate of the signal-to-noise-ratio (SNR) was calculated by defining noise as the portion of the signal in idle state (no cutting, spindle off) and the sensor force signal in the frequency band above 10 Hz. The SNR-values calculated using the RMS of the signals obtained with the Kistler dynamometer and with the developed system were 28 and 22 dB respectively.

## 5 Conclusion and Future Work

This work presented a first attempt for integrating PZT thick film sensors for the purpose of measuring cutting forces in turning processes. A new concept of the sensor

was simulated prior to its fabrication, with the output of the simulation lying within the range of the static calibration of the system. Finally, the system was tested under cutting conditions and compared to a reference dynamometer. The main result of this work is the demonstration of the feasibility of the PZT thick film sensor for measuring quasistatic forces in turning processes. The potential benefits of the system compared to the reference dynamometer consist in an overall cost reduction (which is itself one of the biggest challenges for using near-process force measurements in monitoring of turning processes), a mass reduction by a 3:1 ratio, a potential increase of the bandwidth, and a higher flexibility for integrating the sensors in general tool holder geometries by specifically designing the sensor geometry. Additional aspects to be considered for further qualifying the PZT thick film sensors for process monitoring consist in: (1) extension of FE-analysis to include transient thermal effects in order to evaluate optimal sensor location, (2) evaluation of compensation of temperature drift by using coolant and/or compensation using temperature sensor, (3) analysis of the impact of coolant on the signal quality, (4) development of strategies for compensating the frequency dependent hysteresis, and (5) performing continuous measurements of entire tool life and evaluating sensitivity of signals to wear states compared to reference dynamometer.

## References

1. Teti, R., Jemielniak, K., O'Donnell, G., Dornfeld, D.: Advanced monitoring of machining operations. *CIRP Ann.* **59**(2), 717–739 (2010)
2. Totis, G., Sortino, M.: Development of a modular dynamometer for triaxial cutting force measurement in turning. *Int. J. Mach. Tools Manuf.* **51**(1), 34–42 (2011)
3. Scheffer, C., Kratz, H., Heyns, P.S., Klocke, F.: Development of a tool wear-monitoring system for hard turning. *Int. J. Mach. Tools Manuf.* **43**(10), 973–985 (2003)
4. Klocke, F.: *Manufacturing Processes 1: Cutting*. Springer-Verlag, Berlin (2018)
5. Totis, G., Wirtz, G., Sortino, M., Veselovac, D., Kuljanic, E., Klocke, F.: Development of a dynamometer for measuring individual cutting edge forces in face milling. *Mech. Syst. Signal Process.* **24**(6), 1844–1857 (2010)
6. Klocke, F., Kuljanic, E., Veselovac, D., Sortino, M., Wirtz, G., Totis, G.: Development of an intelligent cutter for face milling. *Strain* **14**, 15 (2008)
7. Drossel, W.-G., Gebhardt, S., Bucht, A., Kranz, B., Schneider, J., Ettrichraetz, M.: Performance of a new piezoceramic thick film sensor for measurement and control of cutting forces during milling. *CIRP Ann.* **67**(1), 45–48 (2018)
8. Dahiya, R.S., Valle, M.: *Robotic Tactile Sensing*. Springer, Dordrecht (2013)
9. Ernst, D., Bramlage, B., Gebhardt, S.E., Schönecker, A.J.: High performance PZT thick film actuators using in plane polarisation. *Adv. Appl. Ceram.* **114**(4), 237–242 (2015)
10. Ewins, D.J.: *Theory and Practice of Modal Testing*. Modal Testing Unit, Mechanical Engineering, Imperial College (1983)



**Open Access** This chapter is licensed under the terms of the Creative Commons Attribution 4.0 International License (<http://creativecommons.org/licenses/by/4.0/>), which permits use, sharing, adaptation, distribution and reproduction in any medium or format, as long as you give appropriate credit to the original author(s) and the source, provide a link to the Creative Commons license and indicate if changes were made.

The images or other third party material in this chapter are included in the chapter's Creative Commons license, unless indicated otherwise in a credit line to the material. If material is not included in the chapter's Creative Commons license and your intended use is not permitted by statutory regulation or exceeds the permitted use, you will need to obtain permission directly from the copyright holder.





# The Costs of More Sustainable Castings Can we Afford the Change?

Lucas Pelchen<sup>(✉)</sup>  and Sebastian Müller 

Institute of Casting Technology, Friedrich-Alexander-Universität Erlangen-Nürnberg,  
Dr.-Mack-Str. 81, 90762 Fürth, Germany  
lucas.pelchen@fau.de

**Abstract.** Rising costs for fossil fuels and the need to reduce emissions in the production of castings are subjecting foundries worldwide to increasing pressure to act and innovate. Due to fierce global competition in this sector and high investment costs for alternative technologies, foundries are therefore under high pressure to transform, while at the same time having limited financial resources. This article examines the economic and environmental differences between a conventional industrial foundry process chain, a process chain based on a hydrogen (H<sub>2</sub>)-fired melting furnace and an all-electric approach using conversion of H<sub>2</sub> to electricity within a solid oxide fuel cell. To ensure an unbiased comparison of the process chains introduced, the respective mass efficiencies are first determined using an absorbing Markov chain before calculating the mass-specific costs and emissions of each approach using a literature-based process model. The comparison of the setups shows negligible differences in terms of material loss and cost in the respective best case. However, significantly higher emission minimums are found for both H<sub>2</sub> approaches compared to the biogas-based conventional approach, especially for the use of green H<sub>2</sub>. In summary, no significant economic disadvantages of the H<sub>2</sub>-based approaches can be identified. Even considering that the economic comparison is biased in favor of biogas due to accounting measures, the environmental difference is comparatively small. The results indicate that the conversion of the foundry industry towards more sustainable H<sub>2</sub>-based foundry process chains is in principle reasonable as well as affordable and should therefore be achieved in the medium term.

**Keywords:** High pressure die casting · absorbing Markov chain · energy demands · greenhouse gas emissions · hydrogen in foundries

## 1 Introduction

Like all energy-intensive industries, the light metal foundry industry, which relies on fossil energy production for 53% of its energy, is under increasing pressure to innovate due to the foundry's cost-intensive energy use and fierce competition for a limited amount of CO<sub>2</sub> certificates [1]. The modification of existing plant technology is cost-intensive and thus represents a potential risk in the economic competition of metal production.

In conjunction with low achievable margins and the need to continuously maintain production operations as a result of supply commitments, a lack of innovation can thus arise [2, 3]. However, due to the rising costs of conventional process chains, the cost differential to more sustainable process chains based on renewable energy is increasingly narrowing. Therefore, a sound prediction of the expected costs for the more sustainable process chains represents a crucial factor for the economic success of the foundry industry. As energy efficiency has been a focus of research in recent decades, a variety of different methods for predicting energy consumption and process emissions for casting processes can be found in the literature. These range from approaches based on thermomechanical models [4, 5] and simulations [6, 7] to audit-based methods [8–13]. While simulations require a deeper understanding of the interactions and physical conditions in the process, audit methods demand a high organizational effort and sufficient industry participation. In the case of the established fossil fuel-based foundry process chain, a sufficient amount of data is available, showing that the range of energy required to produce aluminum castings worldwide is from 0.35 kWh/kg<sub>Cast</sub> to 2.28 kWh/kg<sub>Cast</sub>, depending on process technology and requirements, batch size and equipment. [9, 11, 14–16] The average value of this span – 1,315 kWh/kg<sub>Cast</sub> – results in emissions per ton of aluminum casting between 0.109 kgCO<sub>2</sub>/kg<sub>Cast</sub> and 0.909 kgCO<sub>2</sub>/kg<sub>Cast</sub>, depending on the emission factor of the natural gas combusted. [17] Based on the available literature, no approach could be found to predict energy consumption and process emissions for hydrogen-based casting process chains, which makes it much more difficult for foundries to decide to invest in this technology due to planning uncertainty. In this work, therefore, the energy consumption and emissions per kg of aluminum casting are calculated for two hydrogen-based process chains, one which burns hydrogen (C-route) and the other uses H<sub>2</sub> as an energy source for electric melting technologies (E-route). This information will help accelerate the foundry industry’s transition towards more climate-neutral casting production.

## 2 Methods

### 2.1 Definition of the Process Chain

The casting process chains and thus system boundaries investigated in this work comprise the melting of the aluminum ingots in a melting furnace, the holding of the melt at a target temperature by means of a holding furnace, the actual casting process, and the trimming of the casting at the casting line immediately after casting production. The electrically operated die casting cell and the electrically operated holding furnace are identical in all scenarios examined. These three scenarios – conventional setup (*setup 1*), C-route (*setup 2*) and E-route (*setup 3*) – thus differ only in the energy source of the first process step for melting the aluminum ingots in a furnace. The transition possibilities  $p_i$  from step to step are shown in the arrows between the corresponding steps (see Fig. 1) while the sum of the energetic demands of the respective setups are given under the corresponding title.

- *Setup 1: Conventional setup (Total energy demand: 1.315 kWh/kg<sub>Cast</sub>)*

In conventional plants, the melting furnace is fired with natural gas, using special burners with integrated recuperators that recover the heat in the exhaust gases and thus achieve a higher average efficiency of about 74% [18]. Based on published data in existing literature, the industrial energy demand (including losses) for melting 1 kg of aluminum is estimated at 0.94 kWh/kg<sub>Cast</sub>, of which 90% is generated by natural gas [9, 15, 16]. Taking this distribution into account, the mean value for the fuel demand is 0.846 kWh/kg<sub>Cast</sub>, whereas the mean value for the electrical energy needed results in 0.094 kWh/kg<sub>Cast</sub>. In addition, holding at elevated temperatures as well as processing in the die casting cell consume an average of 0.065 kWh/kg<sub>Cast</sub> and 0.310 kWh/kg<sub>Cast</sub> of electrical energy. [1, 8, 10].

- *Setup 2: C-route (Total energy demand: 1.350 kWh/kg<sub>Cast</sub>)*

The C-Route is based on burners that replace natural gas with hydrogen when firing the melting furnace, minimizing changes to the plant equipment. This results in an almost identical setup, which in turn means that both the burner efficiency and the proportion of electricity required for processing are very similar to those of the conventional setup. Due to the resulting moisture in the exhaust gases, a longer melt cleaning process should be considered for the melt prior to casting processing, resulting in a 1.5 times higher percentage of material waste and energy requirement during holding.

- *Setup 3: E-route (Total energy demand: 1.510 kWh/kg<sub>Cast</sub>)*

The E-Route is an all-electric approach with an electric melting furnace powered either by electricity from a solid oxide fuel cell (SOFC) or from the electrical grid. To meet the foundries' need for a continuous, potentially off-grid energy supply, the option of generating electricity from H<sub>2</sub> is selected for this concept. This leads to a higher energy demand during melting due to the required conversion in the SOFC with an average efficiency of 60%. [19] However, due to the more efficient melting process, the final increase in energy demand is only about 1.23 times that of *setup 1* [6].

## 2.2 Absorbing Markov Chain Model

To describe the material flow within the different process chains, a model based on an absorbing Markov chain is used. This model consists of the three transient states *Melting*, *Holding* as well as *Die-Casting/Trimming* (represented by the indices 1–3) as well as the two absorbing states *Waste* (W) and *Casting* (C). In order to determine the final amount of aluminum that remains in the casting after trimming  $f_{Cast}$ , a corresponding transition matrix was created for each setup. Every matrix contains the percentage of aluminum mass flow from one state to another represented by  $p_{xy}$ , where  $x$  indicates the source and  $y$  the destination of the mass flow.  $f_{Cast}$  is then calculated by multiplying  $p_{12}$ ,  $p_{23}$ , and



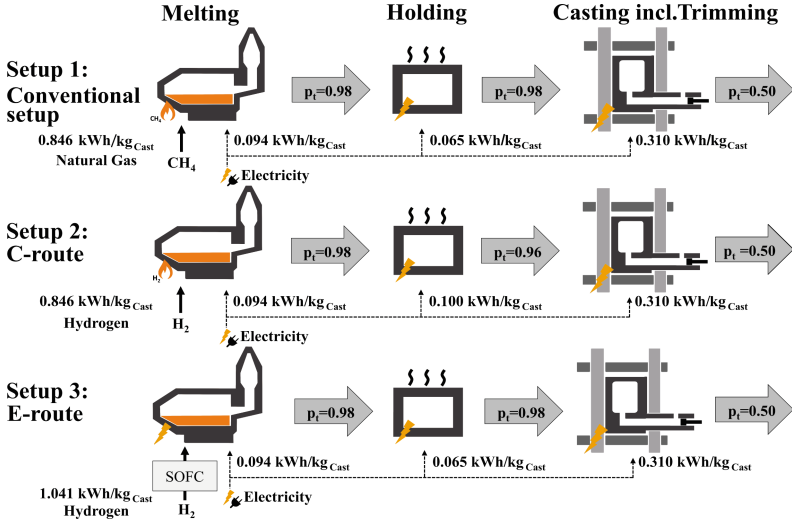


Fig. 1. Schematic overview of the investigated process setups

$p_{3C}$  with 1 kg as nominal ingot quantity.

$$T_{\text{Material}} = \begin{pmatrix} p_{11} & p_{21} & p_{31} & p_{W1} & p_{C1} \\ p_{12} & p_{22} & p_{32} & p_{W2} & p_{C2} \\ p_{13} & p_{23} & p_{33} & p_{W3} & p_{C3} \\ p_{1W} & p_{2W} & p_{3W} & p_{WW} & p_{CW} \\ p_{1C} & p_{2C} & p_{3C} & p_{WC} & p_{CC} \end{pmatrix} \quad (1)$$

### 2.3 Investigated Energy Sources

Depending on the previously presented setups, different energy carriers are required for the process, resulting in a variety of energy costs and emissions in the process chain. The following table 1 provides an overview over the ranges of energy costs  $C_E$  and the corresponding emissions  $Em_E$  per kWh of the energy sources investigated in this paper. Despite the lower costs of directly using green electricity compared to green  $\text{H}_2$  (see Table 1), the on-demand off-grid supply option makes the mixed scenarios more resilient, which is why these energy source combinations were selected for the study.

**Table 1.** Energy carrier and corresponding costs  $C_E$  and emissions  $Em_E$  per kWh

Energy Source	Cost range in $\frac{\text{€}}{\text{kWh}}$ **	Emission range in $\frac{\text{gCO}_2\text{eq.}}{\text{kWh}}$
Biogas	0.03 ... 0.11 [20]**	-19 ... 435 [21]
Blue Hydrogen	0.05 ... 0.09[22]	143 ... 218[22]
Green Hydrogen ( <i>Mains electricity</i> )	0.27 ... 1.85[23]	694[23]
Green Hydrogen ( <i>Electricity from own renewable energy sources</i> )	0.04 ... 0.83[23]	44[23]
Green Electricity	0.13[24, 25]***	146[24]

\* Storage costs are not included in this overview | \*\* Based on Data from 2021 | \*\*\* average german industry costs from 2020 [25] with average extra costs for green-option from 2017[24]

## 2.4 Definition of the Evaluation Criteria

Since the energy demand of an industrial foundry process strongly depends on the mass of the castings produced, the mass-specific costs  $c_i$  and emissions  $em_i$  were chosen for an objective evaluation of the three investigated setups. To calculate the mass-specific criteria for each setup  $i$ , the energy quantities  $e$  for each step  $s$  provided by an energy carrier  $j$  are multiplied by the respective cost factor  $C_E$ , or in case of  $e_i$  by the emission factor  $Em_E$ , for one kWh and added over the total number of process steps  $k$  as well as energy carriers  $n$  before being divided by  $f_{Cast}$ .

$$c_i = \frac{\sum_{s=1}^k (\sum_{j=1}^n e_j \cdot C_{Ej})}{f_{Cast}} \quad (2)$$

$$e_i = \frac{\sum_{s=1}^k (\sum_{j=1}^n e_j \cdot Em_{Ej})}{f_{Cast}} \quad (3)$$

## 3 Results and Discussion

### 3.1 Mass-Specific Efficiencies of the Investigated Setups

Due to the various transition probabilities for the described process chains, each setup has its own value for the mass-specific efficiency  $f_{Cast}$ , as shown in Table 2.

**Table 2.** Overview of mass-specific efficiency

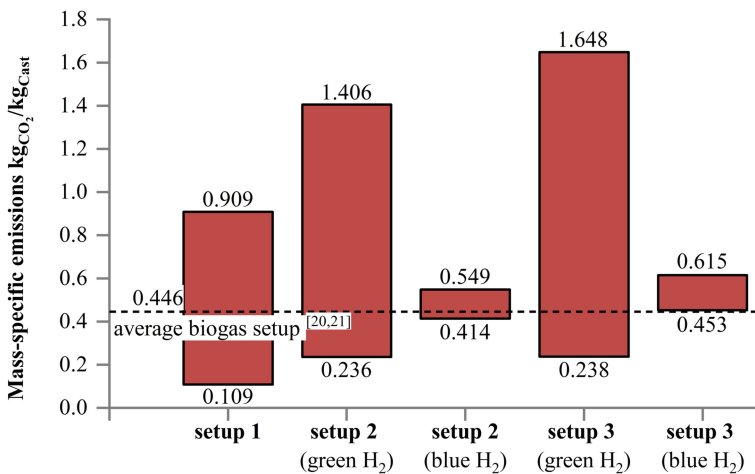
Setup	1	2	3
$f_{Cast}$	0.48	0.47	0.48

As a result of the longer holding time due to the more intensive melt cleaning,  $f_{Cast}$  is lowest at 0.47 in *setup 2*. However, the difference to *setup 1* and *3* with mass-specific

efficiencies of 0.48 each is subordinate. This strongly suggests that in terms of material losses there are no significant disadvantages of the more sustainable routes compared to the conventional industrial setup.

### 3.2 Setup-Specific Emissions

Based on the mathematical relationships from (3), the mass-specific emissions shown in Fig. 2 were calculated for the different setups, taking into account the data given in Table 1. Here, the conventional setup on the basis of a biogas combustion with  $0.109 \text{ kgCO}_2/\text{kg}_{\text{Cast}}$  achieves the lowest minimum emissions of all three setups. The minimum value for green  $\text{H}_2$  is about twice as high at  $0.236 \text{ kgCO}_2/\text{kg}_{\text{Cast}}$  and is exceeded by the values for blue  $\text{H}_2$  with a minimum of  $0.414 \text{ kgCO}_2/\text{kg}_{\text{Cast}}$ . In particular, green  $\text{H}_2$  and biogas thus show a considerable range, which complicates the comparison to some extent and suggests that biogas is partly more sustainable than the use of green  $\text{H}_2$  in foundries. However, the minimum emissions for biogas are only achieved when specific biogenic feedstocks are used as input materials and if the most favorable accounting measures such as waste heat and fertilizer credits are applicable. It must be assumed that these conditions are not met for the majority of industrial consumers, since the specific input materials are not provided in sufficient quantities for an entire industry and are usually only available locally and not sorted by type. On the other hand, considering the average emission value for biogas with  $0.446 \text{ kgCO}_2/\text{kg}_{\text{Cast}}$  instead of the minimum value, the potential of green  $\text{H}_2$ -based plants is clearly shown by almost halving the emissions. It should also be emphasized that the comparatively high emissions of green  $\text{H}_2$  mainly result from the assumption that grid electricity is used for electrolysis. Thus, if electrolysis is carried out with electricity from renewable energy sources, which is becoming increasingly likely due to current technological possibilities and preferences of society, the use of green  $\text{H}_2$  in foundries is significantly more sustainable than keeping the conventional biogas-based plants.



**Fig. 2.** Range of achievable emissions for different process setups in conjunction with corresponding energy sources for melting

### 3.3 Setup-Specific Costs

The setup-specific cost per kg of casting was calculated using the costs from Table 1 and formula (2), with a significant difference in terms of the maximum cost for each setup (see Fig. 3). The lowest cost was calculated at 0.18 €/kg<sub>Cast</sub> for *setup 1*. However, the financial differences from the minimum of *setup 2* with 0.21 €/kg<sub>Cast</sub> for green H<sub>2</sub> and 0.23 €/kg<sub>Cast</sub> for blue H<sub>2</sub> are relatively small, as well as the minimum of *setup 3* with 0.21 €/kg<sub>Cast</sub> and 0.24 €/kg<sub>Cast</sub>. While the maximum costs for biogas with 0.32 €/kg<sub>Cast</sub> and blue hydrogen are identical for *setup 3* and differ only slightly from *setup 2* with 0.30 €/kg<sub>Cast</sub> when using blue H<sub>2</sub> and for *setup 3* with 0.32 €/kg<sub>Cast</sub>, the use of green H<sub>2</sub> causes significantly higher maximum costs of up to 4.14 €/kg<sub>Cast</sub>. Considering these price ranges, especially the process chains based on green H<sub>2</sub> represent an increased financial effort compared to an existing industrial setup with biogas. This diversity of financial efforts for green H<sub>2</sub> is mainly based on electricity costs and electrolyser operating hours, which makes efficient management of the electrolyser urgent for competitive green H<sub>2</sub>-based process chains. Though especially in the case of green H<sub>2</sub>, the maximum costs of the more sustainable plants exceed those of the industrial plants, it becomes clear that the financial differences between the minimum costs for each plant are negligible. Since the price ranges for biogas are based on data from 2021 and a decrease in electrolyser costs is expected, which is based on economies of scale and increased price pressure due to more suppliers in this technological segment, a price parity of biogas and green hydrogen can be expected in the near future.

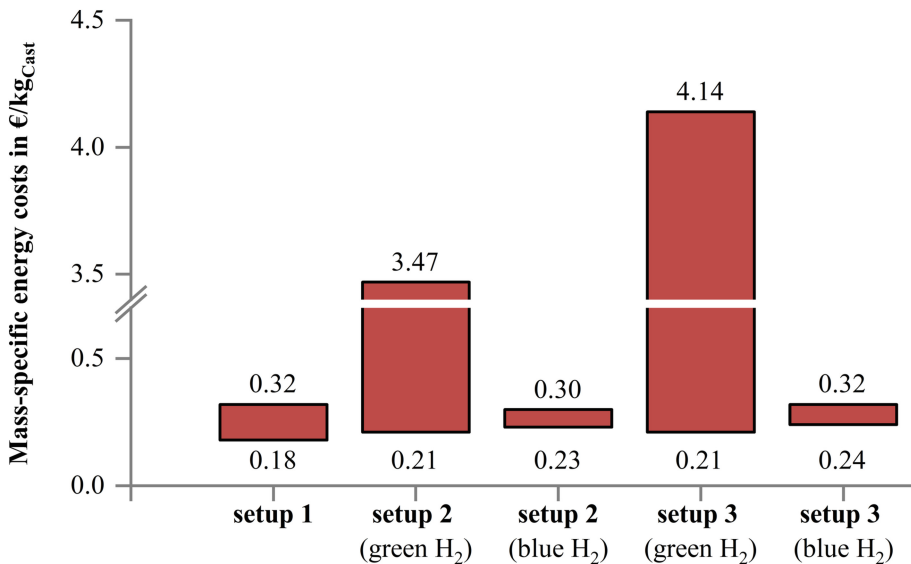


Fig. 3. Range of resulting costs for different setups

## 4 Conclusion and Outlook

The results presented in this work clearly underline that foundry process chains based on green H<sub>2</sub> are likely to become competitive with conventional process chains and are more sustainable than the industrial average in the non-ferrous foundry.

- Using green H<sub>2</sub> has the potential to nearly halving the mass-specific emissions to 0.236 kgCO<sub>2</sub>/kg<sub>Cast</sub> compared to the average of biogas firing with 0.446 kgCO<sub>2</sub>/kg<sub>Cast</sub>.
- Price parity can be achieved for both, green H<sub>2</sub> combustion and electricity generation, if the electricity for electrolysis is sourced from renewable energy sources.

The influences on alloy quality and in-process material losses need to be investigated in further studies using experimental test setups. Nevertheless, the results of this first evaluation indicate the distinct potential as well as the small financial differences between more sustainable H<sub>2</sub>-based process chains compared to a conventional setup. This of course only applies if, from a macroeconomic perspective, sufficient H<sub>2</sub> capacity is made available. It is therefore to be expected that the success of a foundry in the future will depend not only on the technological quality of its products and efficiency of the foundry, but also on the skillful acquisition of energy.

## References

1. Lässig, J., Schütte, T., Riesner, W.: *Energieeffizienz-Benchmark Industrie Energiekennzahlen für kleinere und mittlere Unternehmen*. Springer Verlag, Berlin (2020)
2. Trianni, A., Cagno, E., Thollander, P., Backlund, S.: Barriers to industrial energy efficiency in foundries: a European comparison. *J. Clean. Prod.* **40**, 161–176 (2013)
3. Haraldsson, J., Johansson, M.T.: Barriers to and drivers for improved energy efficiency in the Swedish aluminium industry and aluminium casting foundries. *Sustainability* **11**(7), S.2043 (2019)
4. Chen, E., Li, H., Cao, H., Wen, X.: An energy consumption prediction approach of die casting machines driven by product parameters. *Front. Mech. Eng.* **16**, 1–19 (2021). <https://doi.org/10.1007/s11465-021-0656-0>
5. Selvaraj, J., Marimuthu, P., Devanathan, S., Ramachandran, K. I.: Mathematical modelling of raw material preheating by energy recycling method in metal casting process. *Intell. Syst. Technol. Appl.*, 766–769 (2017)
6. Salonitis, K., Jolly, M., Zeng, B.: Simulation based energy and resource efficient casting process chain selection: a case study. *Procedia Manuf.* **8**, 67–74 (2017)
7. Henninger, M., Schlüter, W., Jeckle, D., Schmidt, J.: Simulation based studies of energy saving measures in the aluminum tool and die casting industry. In: *Applied Mechanics & Materials*, p. 856 (2016)
8. Brevick, J., Mount-Campbell, C., Mobley, C.: *Final Report on Energy Consumption of Die Casting Operations*, United States (2004)
9. Gonçalves, M., Jolly, M.R., Salonitis, K., Pagone, E.: Resource efficiency analysis of high pressure die casting process. In: Martin, O. (ed.) *TMS 2018. TMMMS*, pp. 1041–1047. Springer, Cham (2018). [https://doi.org/10.1007/978-3-319-72284-9\\_136](https://doi.org/10.1007/978-3-319-72284-9_136)
10. Röders, G., Indorf, C., Dilger, K., Pries, H., Anders, U.: *Optimierung der Energiebilanz beim Aluminium-Druckguss*, Deutsche Bundesstiftung Umwelt (2006)

11. Schwegler, R., Schmidt, M., Keil, R.: Erfolgsfaktoren für betriebliches Energie- und Stoffstrommanagement (EFAS), Pforzheimer Forschungsberichte Nr. 7 (2007)
12. Lazzarin, R.M., Noro, M.: Energy efficiency opportunities in the production process of cast Iron foundries: an experience in Italy. *Appl. Therm. Eng.* **90**, 509–520 (2015)
13. Schwam, D.: Energy saving melting and revert reduction technology: melting efficiency in die casting operations (2012)
14. He, K., Tang, R., Jin, M., Cao, Y., Nimbalkar, S.U.: Energy modeling and efficiency analysis of aluminum die-casting processes. *Energ. Effi.* **12**(5), 1167–1182 (2018). <https://doi.org/10.1007/s12053-018-9730-9>
15. Herrmann, C., Pries, H., Hartmann, G. (eds.): Springer, Heidelberg (2013). <https://doi.org/10.1007/978-3-642-39853-7>
16. Salonitis, K., Zeng, B., Mehrabi, H.A., Jolly, M.: The challenges for energy efficient casting processes. *Procedia CIRP* **40**, 24–29 (2016)
17. Juhrich, K.: CO<sub>2</sub>-Emissionsfaktoren für fossile Brennstoffe. *Clim. Change* **27** (2016)
18. Furu, J.: An Experimental and Numerical Study of Heat Transfer in Aluminium Melting and Remelting Furnaces (2013)
19. Bosch Homepage. <https://www.bosch.com/stories/sofc-system/>. Accessed 13 Apr 2022
20. Reinholz, T., Völler, K.: Branchenbarometer Biomethan 2021, Berlin (2021)
21. Bachmaier, H., Bayer, K., Gronauer, A.: Treibhausgasemissionen der Energieproduktion aus Biogas.(2009)
22. Bukold, S.: Kurzstudie - Blauer Wasserstoff. Greenpeace Energy(2020)
23. Bullmann, T., Gollnick, C., Schorpp, J.: Wasserstoff DIHK-Faktenpapier (2020)
24. Hauser, E., Heib, S., Hildebrand, J.: Marktanalyse Ökostrom II. *Clim. Change* **30** (2019)
25. BMWI: BMWI – Energiedaten, Tabelle 29a (2021)

**Open Access** This chapter is licensed under the terms of the Creative Commons Attribution 4.0 International License (<http://creativecommons.org/licenses/by/4.0/>), which permits use, sharing, adaptation, distribution and reproduction in any medium or format, as long as you give appropriate credit to the original author(s) and the source, provide a link to the Creative Commons license and indicate if changes were made.

The images or other third party material in this chapter are included in the chapter's Creative Commons license, unless indicated otherwise in a credit line to the material. If material is not included in the chapter's Creative Commons license and your intended use is not permitted by statutory regulation or exceeds the permitted use, you will need to obtain permission directly from the copyright holder.



# **Supply Chain and Remanufacturing**



# reProd<sup>®</sup> – Resource-Autarkic Production Based on Secondary Semi-finished Products

Markus Werner<sup>(✉)</sup>, Rico Haase, and Christian Hermeling

Fraunhofer Institute for Machine Tools and Forming Technology, Reichenhainer Str. 88, 09126 Chemnitz, Germany

markus.werner@iwu.fraunhofer.de

**Abstract.** This paper presents a novel approach of a smart shortened material loop for producing second-life metallic components by saving a significant amount of energy and CO<sub>2</sub> emissions. The focus is on metallic components and manufacturing chains based on adapted forming technologies. Sourcing and using secondary semi-finished products instead of virgin metallic materials facilitates the omission of process steps, such as iron smelting, steel making, continuous casting, hot and cold rolling, which involve the highest energy consumption and the highest CO<sub>2</sub> emissions. Besides the positive impacts on sustainability, there are still scientific and technological challenges. One challenge lies in matching providers of secondary semi-finished material to market needs; the other comprises engineering the forming process chain while some material characteristics are not clearly specified or vary in a wide range. In contrast to the heavily restricted properties of virgin material, the characteristics of secondary semi-finished materials vary in a wider range and need to be elaborated. In the end, a new component will be produced, differing in design, function, and properties from conventional, single-life cycle products. Therefore, this paper introduces a novel, circular material loop for metals. The paper finishes with a short concept note on digital material and product passports to store and provide the required information on properties.

**Keywords:** Material loop · Metal recycling · Secondary semi-finished products

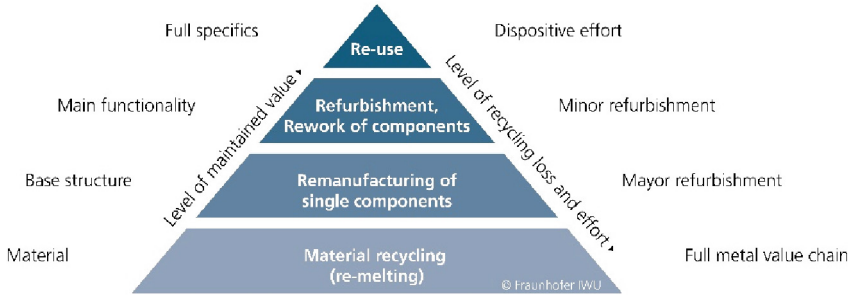
## 1 The reProd<sup>®</sup> Approach

### 1.1 Metallic Cycle and the Idea of reProd<sup>®</sup>

This paper describes the latest developments in production technologies within the scope of sustainable material loops. The focus lies on metal parts and components and on forming technologies. The Fraunhofer Institute for Machine Tools and Forming Technologies focuses on resource efficiency in industrial production environments. Material efficiency primarily means manufacturing as much as possible from raw materials. From an ecological point of view and inspired by nature, this paradigm should be shifted to holistic material effectiveness by choosing raw materials which are easy to reuse, remanufacture and recycle. There are several ways to use materials as intensively as possible. Figure 1



shows four paths between “re-using the product as it is” and “material recycling focusing on metallic cycles”. On the left side of the pyramid, the level of maintained value increases from bottom to top, while on the right side, the level of recycling losses and efforts decrease.



**Fig. 1.** Pyramid presenting values, level of maintained value (left) and the level of recycling loss and amount of effort (right)

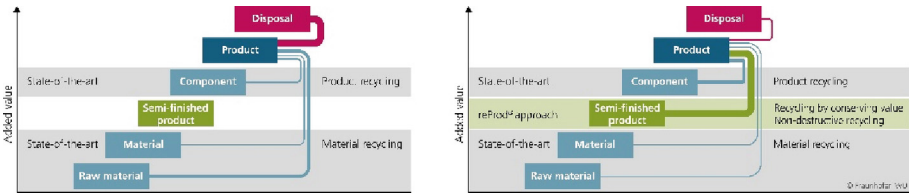
Beside numerous other materials, metals are a type of permanent material with high recyclability [1]. However, metallurgical processes require an enormous amount of energy, causing the emission of greenhouse gases, in particular CO<sub>2</sub>. To stop or at least to lower the impact on climate change, it is necessary to reduce the CO<sub>2</sub> footprint significantly, even though the market volumes for aluminium and steel are still growing. The WellMet2050 [1] program addressed four themes to overcome this dilemma:

- Theme 1: Reusing metal without melting
- Theme 2: Less metal, same service
- Theme 3: Using metal products more intensively and for a more extended period
- Theme 4: Managing heat and shortening supply chains

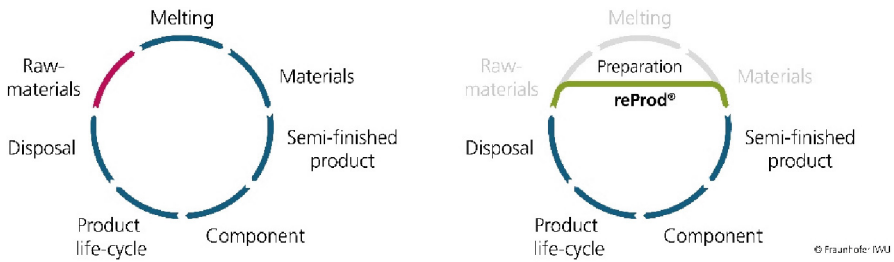
## 1.2 The reProd<sup>®</sup> Approach

The analysis of today’s economy shows a predominantly linear structure also known as cradle to grave. This recycling type is characterized by a high fraction of disposal, as shown in Fig. 2 (left). In contrast, the reProd<sup>®</sup> approach illustrates an obviously smaller fraction of disposal, see Fig. 2 (right). However, the main difference is a shortened loop from product to semi-finished product to new components and new products. In this context, new means another product with a different function. The new cycle is based on obtaining semi-finished products out of used products and processing them directly without the detour of scrap and the related recycling effort.

The new cycle, called the reProd<sup>®</sup> cycle, represents an ideal resource autarkic production and material cycle based on secondary semi-finished products. Shortening the common metallic cycle offers a significant potential for improving sustainability while skipping the most energy-consuming and CO<sub>2</sub>-emitting processes. Figure 3 shows the smart shortened cycle.

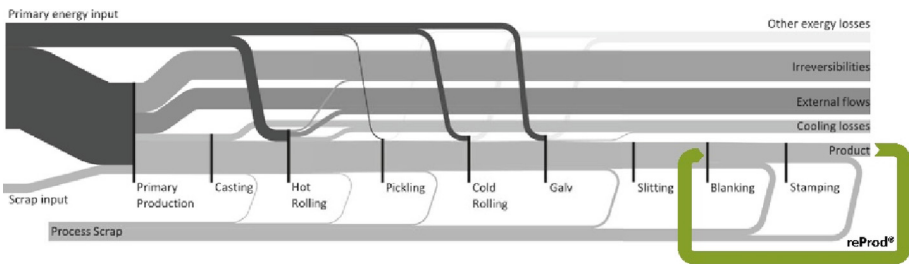


**Fig. 2.** Material cycles: today’s cycle with small amount of cycling and large fraction on disposal (left) and the reProd<sup>®</sup>-cycle [4] closed on semi-finished product level (right) as the highest loop after reuse and a less destructive recycling compared to the common material recycling.



**Fig. 3.** The standard metal cycle and the smart shortened reProd<sup>®</sup> cycle by cutting off the most energy-consuming and CO<sub>2</sub>-emitting process steps, such as melting and hot rolling.

Figure 4 shows the estimated exergy flow map for a steel product by Allwood [2], representing the enormous losses. The reProd<sup>®</sup> route extends the figure to demonstrate the potential for reducing the environmental impact and the challenge for sustainability.



**Fig. 4.** Estimated exergy flow map for sheet steel products [2] extended by the reProd<sup>®</sup> cycle illustrates the significant reduction of losses.

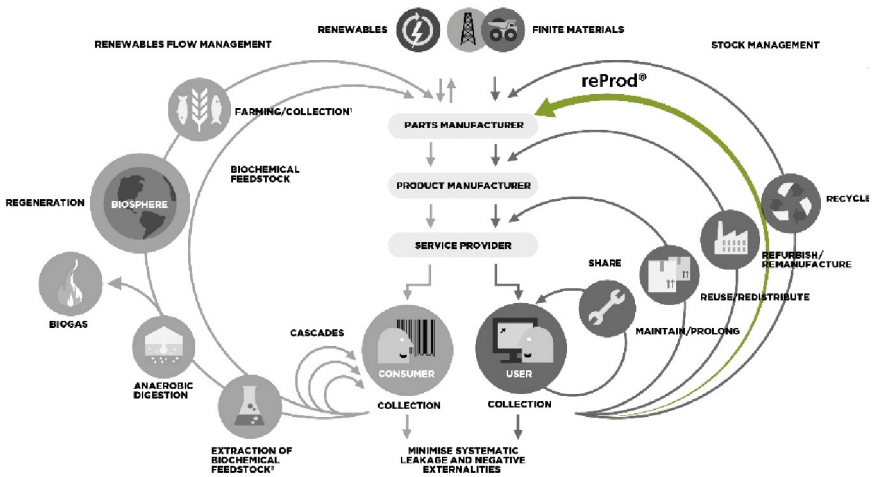
Table 1 lists representative figures for three analysed steel routes to underline this potential. Compared to the primary steel route, the reProd<sup>®</sup> approach offers an 84% reduction in energy consumption and an 82% reduction in CO<sub>2</sub> emissions. Even compared to the primary steel route, there still is a 65% reduction in energy consumption and a 63% reduction in CO<sub>2</sub> emissions.

**Table 1.** Energy consumption, CO<sub>2</sub> emissions and CO<sub>2</sub> reduction for three different steel routes (reduction compared to primary steel route)

Cycle	Based on	Energy consumption	Energy reduction	CO <sub>2</sub> emission	CO <sub>2</sub> reduction
primary steel route	iron ore and coal	22 GJ/t	ref	1.7 t CO <sub>2e</sub> /t	ref
secondary steel route	iron ore, coal, and steel scrap	10 GJ/t	– 65%	0.8 t CO <sub>2e</sub> /t	– 62%
reProd <sup>®</sup> route	semi-finished products	3.5 GJ/t	– 84%	0.3 t CO <sub>2e</sub> /t	– 82%

### 1.3 The reProd<sup>®</sup>-cycle

The reProd<sup>®</sup> cycle represents a cradle-to-cradle (C2C) cycle. Furthermore, the new approach is a paradigm shift from waste to resource management called "non-destructive recycling". A comparison of the published circular economy cycles (shown in Fig. 5) with the proposed cycle reveals several differences. Besides reducing energy consumption and emissions, it allows the manufacturing of new products with changed functionalities maintaining the highest value-added level.

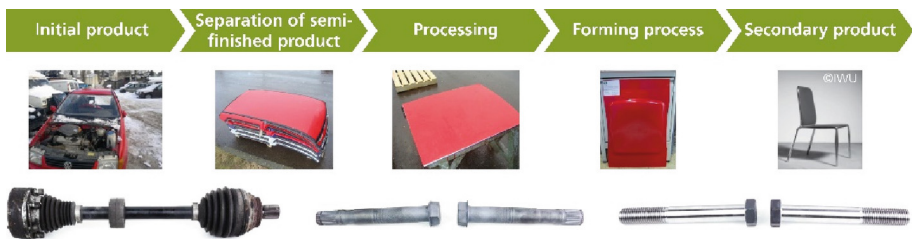


**Fig. 5.** Circular economy cycles based on the Ellen MacArthur Foundation extended by reProd<sup>®</sup> cycle [3]

Sharing products, repairing them, and refurbishing them means using the same products as long as possible, maybe with software updates. This approach is quite opposite to our current consumer society. The reProd<sup>®</sup> cycle offers a way to overcome this drawback and market barrier; therefore, it represents a new cycle different from the known ones [3].

## 1.4 Feasibility Studies

Regarding research and development in a circular economy, there are several options to open the loop of a further product cycle. It is substantial to start with an eco-design or a circular product design, as described by Hollander [4]. It takes a period of at least one cycle to realize one of these designs and obtain feedback. Another option consists of using what is already available in a scrap yard and starting the learning process there. Several demonstration examples are manufactured to prove the idea of resource autarkic cycles and to show its feasibility. Figure 6 presents the cycle for sheet metal parts. It starts with cutting blanks from car roofs at scrap yards. The roofs are trimmed, and some are cleaned by removing coating and adhesives. After preparation, a hydroforming process was chosen to form the desired shape of a seat- and back-panel of a design chair (Hydra). Even the coloured panels could be formed to the desired shape without colour loss, as shown in Fig. 6 [5].



**Fig. 6.** Process chain from scrap yard (top left) to obtain semi-finished products, trimming and preparation of car roofs (top centre), result of hydroforming operation and finished design chair (top right) and used drive shaft (bottom left) as secondary semi-finished part for bulk metal forming (bottom centre) to realize high-performance screws (bottom right) for application in wind turbines.

In order to open up the enormous potential for sustainability, however, it is essential to provide or create the required information. For the engineering process, it is necessary to know the material condition of the secondary semi-finished products to design the production steps leading the way to the second life cycle. The process design is based on forming simulation, which requires detailed description of the material behaviour. The assessment of the currently unknown or at least uncertain material properties, such as strength and residual formability, are presented and discussed below.

## 2 Engineering and Processing Secondary Semi-finished Products into New Parts

Metalworking and the related process development is a well-established and highly mature branch with broad industrial applications. At the same time, a high level of specialization and a complex process chain exists in the development of the forming processes. In particular, this includes finite element (FE) based engineering.

The impact on the changed material must be regarded flawlessly in the CAE workflow when aiming at economically applying secondary finished products as a replacement for

conventional virgin materials. Thus, changes have to be identified and values need to be quantified. Due to the diverse nature of secondary semi-finished products, existing uncertainties need at least to be estimated by confidence intervals.

## 2.1 Geometric Properties

The variety in geometric appearance of secondary semi-finished products is obvious. Using the example of a sheet metal component, the potentially complex 3D shape, the trim line geometry and locally distributed sheet metal thickness pose a strong contrast to virgin material, which comprises a homogeneous, flat and regularly edged sheet.

According to the state of the art, the 3D shape can be recaptured, and local material thinning could be estimated based on, e.g., a one-step solver unfolding the blank. This process generates a complex dataset and comprises a remarkable effort for modelling the initial forming operation, which is detrimental to the economic competitiveness of the material. Thus, a generalized approach is required, representing the shape of the part sufficiently for establishing feasibility and works without localized characterization of the part geometry. By applying the Gauss curvature value, information on the size and orientation of the curvature can be expressed by scalar values.

$$K = k_1 * k_2 = \frac{1}{r_1} * \frac{1}{r_2}$$

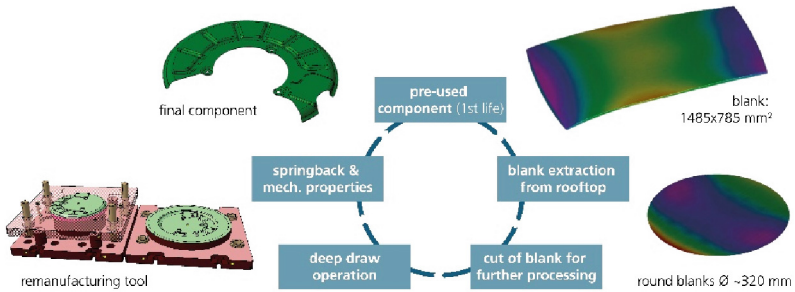
If the minor curvature is zero, pure bending can unfold the blank. If the Gauss value is below zero, the orientation of the radii is counter-wise; therefore, the part features a saddle shape. Large Gauss values result in severe strain levels, which must be applied to flatten the blank, before forming can take place. Aiming for the robustness of the remanufacturing operation, limit values for the single curvature and the Gauss value can be elaborated using an FE analysis of the actually desired shape.

## 2.2 Mechanical Properties

Mechanical properties are influenced by the previous forming operation, heat treatment operations and potential influences during the use phase. During the initial forming operation, strains are applied to the material, generating a work hardening effect. The initial strain is stored and transferred into the downstream forming operation, which provokes the flow curve to shift. This increase in forming resistance is also caused by bake hardening, which is quite common in automotive applications.

Micro-alloyed steels are frequently applied in car body manufacturing. Therefore, a typical HX220YD from the roof of a station wagon (shown in Fig. 7) was characterized. During deep or even stretch drawing of outer body shells, an equal material thinning of approx. 2–3% is intended to trigger the work hardening effect mentioned above. The latter initiates a slight increase of the initial flow stress of approx. 15 MPa. Afterwards, the cathodic dip coating further increases this flow stress by approx. 35 MPa. If the plastic strain is raised, which also implies an increase in the share of work hardening, the bake hardening decreases; and vice versa.

Therefore, an overall increase in flow stress of 50 MPa can be assumed. However, the elongation until fracture slightly decreases from an initial value of  $\geq 34\%$  to 20–25%. Furthermore, a stochastic scatter has to be considered in the feasibility analysis.

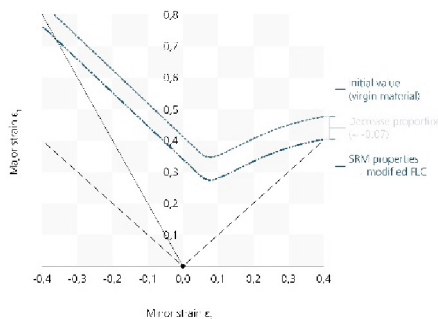


**Fig. 7.** Investigated reProd<sup>®</sup> cycle realized within EU project CarE-Service. This project has received funding from the European Union’s Horizon 2020 Research and Innovation Programme under grant agreement No 776851.

### 2.3 Process Design Workflow

Two different scenarios have been modelled based on the geometric and mechanical properties. Initially, an AutoForm<sup>®</sup> finite element analysis was performed regarding the entire process chain, including.

- First forming operation to manufacture a station wagon roof,
- Extraction of blanks from the secondary semi-finished product,
- Second forming operation into a brake disk cover, including the flattening of the blank by the closing binder.



**Fig. 8.** Formability of virgin material and secondary semi-finished product

This approach comprises straightforward engineering but requires the detailed knowledge and modelling of the previous forming operation. These efforts were replaced by reasonable assumptions to aim for an economically feasible solution. Accordingly, a modified “pre-aged” material model was established. This material model includes: an increased flow curve and a decreased forming limit curve (FLC). The FLC was generated from waisted Nakajima specimen, as shown in Fig. 8.

### 3 Outlook - the Potentials of a Digital Chain

#### 3.1 Digital Shadow as Missing Link Between the $n^{\text{th}}$ - and the Next Product Life Cycle

Today's transformation to Industry 5.0 [6] is based on digitalization of almost all real-life phenomena. The demand for consistent simulation chains seems to be overcome, but digital shadows and virtual twins are not yet prepared for second or even further product life cycles. Without a doubt, there are significant benefits for digital transformation and the sustainability of manufacturing. The second and following life cycles clearly benefit from product models, especially material models and data. This approach enables the re-use of products and components, overcoming the difficulties of unknown conditions of components and materials. Moreover, digitalization generates information that implies added value for the specific product.

The challenge lies in fitting the required information into a small data format containing the essential data for the following loops. At the same time, the exact requirements for the day after tomorrow are unknown. The design of sustainable products shall shift from material consumption to products as repeated periods of material utilization in an eternal recycling loop.

### References

1. Allwood, J., Cullen, J.: Steel, aluminium and carbon: alternative strategies for meeting the 2050 carbon emission targets (2009)
2. Allwood, J.M.: Steel and aluminium in a low carbon future. In: Special Edition: 10th International Conference on Technology of Plasticity, ICTP 2011, pp. 27–42 (2011)
3. The butterfly diagram: visualising the circular economy (ellenmacarthurfoundation.org). <https://ellenmacarthurfoundation.org/circular-economy-diagram>
4. den Hollander, M.C., Bakker, C.A., Hultink, E.J.: Product design in a circular economy: development of a typology of key concepts and terms. *J. Ind. Ecol.* **21**, 517–525 (2017). <https://doi.org/10.1111/jiec.12610>
5. Landgrebe, D., Kräusel, V., Bergmann, M., Werner, M., Rautenstrauch, A.: Conserving resources in production - breaking new ground. *Procedia Manufact.* **8**, 619–626 (2017). <https://doi.org/10.1016/j.promfg.2017.02.079>. ISSN 2351-9789
6. [https://ec.europa.eu/info/research-and-innovation/research-area/industrial-research-and-innovation/industry-50\\_en](https://ec.europa.eu/info/research-and-innovation/research-area/industrial-research-and-innovation/industry-50_en)

**Open Access** This chapter is licensed under the terms of the Creative Commons Attribution 4.0 International License (<http://creativecommons.org/licenses/by/4.0/>), which permits use, sharing, adaptation, distribution and reproduction in any medium or format, as long as you give appropriate credit to the original author(s) and the source, provide a link to the Creative Commons license and indicate if changes were made.

The images or other third party material in this chapter are included in the chapter's Creative Commons license, unless indicated otherwise in a credit line to the material. If material is not included in the chapter's Creative Commons license and your intended use is not permitted by statutory regulation or exceeds the permitted use, you will need to obtain permission directly from the copyright holder.







# Reducing Remanufacturing Uncertainties with the Digital Product Passport

Viola Gallina<sup>1</sup>(✉), Barna Gal<sup>1</sup>,  Szaller<sup>2</sup>, Daniel Bachlechner<sup>1</sup>,  
Elisabeth Ilie-Zudor<sup>3</sup>, and Wilfried Sihl<sup>1,4</sup>

<sup>1</sup> Fraunhofer Austria Research GmbH, Theresianumgasse 7, 1040 Wien, Austria  
[viola.gallina@fraunhofer.at](mailto:viola.gallina@fraunhofer.at)

<sup>2</sup> EPIC InnoLabs, Kende Street 13–17, Budapest, Hungary

<sup>3</sup> Institute for Computer Science and Control (SZTAKI), Kende Street 13–17,  
Budapest, Hungary

<sup>4</sup> Vienna University of Technology, Institute of Management Science,  
Theresianumgasse 27, 1040 Wien, Austria

**Abstract.** In contrast to the linear production model, the circular economy aims to close the loop of materials. One part of this approach is remanufacturing, which extends the lifetime of products. Various stakeholders in the supply chain are involved in remanufacturing. This makes the management and optimization of remanufacturing activities complex. The data required for optimization is often missing, which leads to uncertainties. A new European Commission initiative, the digital product passport (DPP), is believed to facilitate information exchange in the supply chain and could be a good solution to reduce uncertainties. The primary purpose of this paper is the quantification and evaluation of the advantages of the DPP. Based on real industrial data, a discrete event simulation model of a remanufacturing system with three production lines was developed. The authors suppose the hypothetical existence of a DPP and illustrate the benefits arising from its application.

**Keywords:** digital product passport · simulation · evaluation · uncertainties

## 1 Introduction

Digitization is one of the enablers of the transition towards a more sustainable circular economy. It can help closing the loop of the linear production model by providing data on the whole product life cycle. One particular tool, the DPP is investigated in this paper, which facilitates more efficient processes in the supply chain. Among others, the DPP might be an efficient tool for reducing uncertainties in remanufacturing processes. The aim of this paper is the quantification of the benefits that can be gained with the help of the DPP and illustrate it with a real industrial use case from the machine construction industry. The paper is structured as follows. The next chapter gives an overview on the state-of-the-art regarding remanufacturing uncertainties, the DPP and data exchange.

 The Author(s) 2023

H. Kohl et al. (Eds.): GCSM 2022, LNME, pp. 60–67, 2023.

[https://doi.org/10.1007/978-3-031-28839-5\\_7](https://doi.org/10.1007/978-3-031-28839-5_7)

Chapter three discusses the theoretical possibilities for lowering uncertainties with the DPP resulting in an automatic efficiency increase during remanufacturing. A simulation model of a real remanufacturing system with the quantified benefits is presented in chapter four. The last chapter concludes the paper and outlines the future research agenda.

## 2 Literature Review

### 2.1 Uncertainties in Remanufacturing

Suzanne et al. [18] define remanufacturing as a recovery operation of used products for rebuilding to a like-new condition. In most cases the remanufactured products are offered with very similar guarantee conditions as new products. The six steps of remanufacturing are entrance diagnosis, disassembly, cleaning, inspection, reconditioning and reassembly [17]. The main particularity of remanufacturing resides in product disassembly. Remanufacturing is much more challenging than manufacturing in the classical linear production model. The main reason for this lies in complicating factors such as uncertainties that arise during remanufacturing. The uncertainties are well documented in the scientific literature. Junior and Filho [12] summarize these factors with a focus on the period from 2000 to 2009: i) uncertain timing and quantity of returns; ii) balancing returns and demands; iii) disassembly of returned products; iv) uncertainty in materials recovered from returned products; v) requirement for a reverse logistics network; vi) material matching restrictions; vii) highly variable processing times during remanufacturing; viii) stochastic material routings. Ropi et al. [11] concentrate on the period between 2013 and 2021 and refine the grouping of uncertainties as follows: i) demand; ii) return yield; iii) inventory; iv) cost; v) quality and vi) environment.

It must be noted that *disassembly* is not simply the inverse operation of assembly. Typically, the quality of the components of the returned products can be revealed only after disassembly and just then the classification regarding reusability becomes possible – such as reusable with or without reconditioning, or not reusable.

### 2.2 The Digital Product Passport

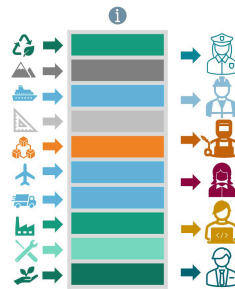
The digital product passport (DPP) has recently gained increased attention by policymakers at the European Commission, who are requiring the implementation of DPPs – facilitating the digital transformation leading to a healthier and greener society [7]. The DPP “could provide information on a product’s origin, composition, repair and dismantling possibilities and end of life handling” [8].

However, the idea of gathering data on the whole product life cycle is not novel. Barco and Charnley [3] present a case study of a high pressure nozzle guide vane on data acquisition by sensors and discussed data requirement issues regarding a DPP. An immature concept of product life integration – containing design, manufacturing, packaging, customer use and finally recycling or disposal – can be found

in a strategical document of Hewlett-Packard from 1995 [10]. In the context of building, the material passport is often used. The material passport is a qualitative and quantitative documentation of the material composition of a building, showing the materials embedded in buildings as well as their recycling potential and environmental impact. This enables different actors in the building sector to continuously collect and evaluate data for building components [19]. A similar data gathering approach is the cradle-to-cradle passport, that contains information on raw materials, disassembly and recycling plan on cars. In addition, individual (large) companies already have their own internal passport approaches in certain areas. They are not uniform solutions for a whole car, but island solutions for particular problems – such as Polestar’s transparent cobalt supply chain realized with blockchain [6]. Herrgoß et al. [14] evaluate distributed ledger technology for production planning and concluded that “blockchain enables a guaranteed level of security, transparency and immutability that no centralized data storage technology can provide at this time”. Kouhizadeh et al. [13] investigate the blockchain’s potential in benefiting the circular economy and conclude that more industrial examination is needed in this context. Gligoric et al. [9] use Internet of Things concepts for building a DPP.

The German Government picked up the discussions on the DPP at the European level and developed a political concept on the DPP. The German Federal Ministry for the Environment, Nature Conservation and Nuclear Safety (BMU) defines the DPP as a data set that summarizes the components, materials and chemical substances or also information on reparability, spare parts or proper disposal for a product [1]. According to the BMU, the DPP should be applicable to all products and services – including foodstuff – and the Ministry proposes the Commission to focus on textiles, electronics, construction, packaging, batteries and electric vehicles. Totaro [2] extends this list with fashion, furniture as well as “high impact intermediate products” such as steel, cement and chemicals.

The DPP is seen as a tool for enabling holistic and comprehensive data recording of environmental and social sustainability aspects. It gives the possibility to “track and trace” information on the whole supply chain. Doing so, it might overcome one of the biggest hurdles of the circular economy model, namely the lack of information on the various stakeholders of the supply chain. The benefits of a transparent supply chain are manifold: i) producers and retailers: competitive advantage; ii) users: more environmental-conscious product consumption, increased trust in case of buying used products; iii) remanufacturers: decreased uncertainties, access disassembly guides and components, cost and time efficient disassembly; iv) certifiers:



**Fig. 1.** Schematic visualization of the DPP content (own illustration according to Luscuere [16])

collect data more easily – to name just a few. Introduction of a DPP can have high significance also in regard to waste management, in two distinct phases: process control, respectively decommissioning (disposal or recycling). Expected benefits of a DPP supported waste management are: i) reduced time-in-storage of dangerous wastes; ii) decreased storing costs of parts; iii) reduced emissions; iv) production optimization to avoid waste and energy losses.

The various stakeholders might gain the above mentioned benefits based on different information obtained from the DPP. However, the content of the DPP is generated by different actors of the supply chain. Figure 1 depicts the actors involved in the context of DPP. E.g., the manufacturer on the left side (including product designers and production engineers) can give information on the materials and components of a product. The consumer on the right side can make his or her product choice not just based on the information created by the manufacturer, but on the environmental information provided by different certification bodies. Another beneficiary on the right side, such as a remanufacturer, however, needs more detailed information regarding disassembly and previous life of the product. This means that the product information can be relevant to different groups with different levels of detail. Berger and her coauthors give a conceptual overview on battery passport containing three information levels [4]. This paper focuses on remanufacturers as a stakeholder group: their data requirements and the benefits they might gain are investigated. In the industrial use case, manufacturing and remanufacturing take place in the same company, on the same shopfloor, but on different production lines. With the existence of the DPP, the remanufacturer might have access to information that leads to increased efficiency.

### 2.3 Transparent and Secure Infrastructure and Proper Governance

Potential stakeholders are aware that information exchange in the supply chain may well be beneficial for society as a whole or for some stakeholders, but may also bring disadvantages for others [5]. The fact that laws may be violated (e.g., data protection, intellectual property, liability) or trade secrets may be compromised leads to reluctance to exchange information. If stakeholders are not forced to exchange information, they will weight opportunities and risks carefully. Other than the Supply Chain Act, which is likely to result in some form of DPP – but aimed at eliminating production processes and working conditions that violate human rights rather than enabling or supporting remanufacturing activities – there is no expected legislative pressure related to information exchange in the value chain. It is also not foreseeable for the time being that dominant suppliers or customers will force their business partners to exchange information that facilitates remanufacturing. Therefore, DPPs must be designed to convince a critical mass of relevant stakeholders. This means that DPPs must use a transparent and secure infrastructure, which ensures that stakeholders retain sovereignty over their data [1]. In addition, proper governance is required to ensure fairness and accountability. Gaia-X, an open data infrastructure based on European values that is currently being implemented, could be suitable as foundation for DPPs.

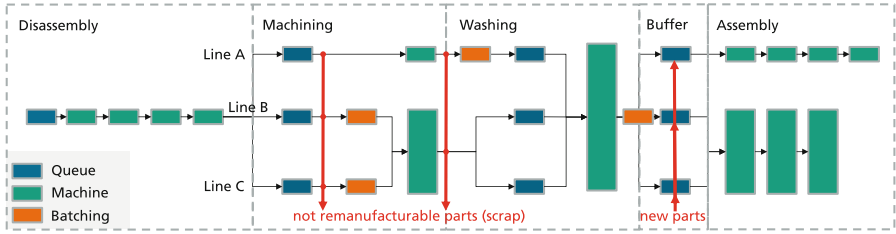
### 3 Possibilities for Uncertainty Reduction with the DPP

One of the biggest problems is that remanufacturers do not have any information on the *quality* of product components before the disassembly is finished. Two identical components from two different products can have various conditions. It might result in different process flows with diverse material and component routings with highly variant process times and lead times. In the DPP, the product users might share information on the usage, maintenance and repair activities on the product – in the optimal case, in an automated way. A higher level of information regarding the quality of the product and its components might lead to processes with lower variance, better predictable production schedules and in the end better logistical KPIs: lower work-in-progress and inventory levels, reduced average lead times, higher capacity utilization and higher adherence to schedules.

The remanufacturers are also not familiar with the *timing and quantity* of returned products. The product mix requiring remanufacturing and competing for scarce resources is not known well before and it makes production planning even more challenging. Information content regarding timing and quantity of the returns in the DPP – in an aggregated way according to product or product variants – might result in more effective and optimized remanufacturing production plans.

### 4 Simulation Model of a Real Remanufacturing System

In a remanufacturing plant for gas engines, the uncertainties presented in previous chapters could be observed. The condition in which the cylinder heads arrive at the remanufacturing plant only becomes apparent after the gas engines have been disassembled and, in some cases, after the cylinder heads have been machined. Today, instead of a DPP, markings are mechanically placed on the cylinder heads with a center punch to indicate the number of life cycles before the heads become scrap. In the present manufacturing process, cast casings of reclaimed cylinder heads are disassembled, machined, and reassembled after reaching end-of-life status. This results in new remanufactured cylinder heads, which are essential assemblies to overhaul gas engines and can be used for a maximum duration of three product life cycles in gas engines. The uncertain timing, the quality and reusability of the reconditioned components and assemblies pose special problems for the manufacturer. In order to keep supply and demand in balance, the manufacturer has to accept both increased stock-keeping, the provision of increased production capacities available at short notice, and the regular use of cost-intensive new parts. This results in monetary losses and waste in production for the manufacturer as well as bottlenecks in material supply for gas engine assembly.



**Fig. 2.** Flowchart and simulation model for evaluating the effect of the DPP

Discrete event-based simulation (DES) models are used to support decision making, evaluation of a system operation and for riskless comparison of different scenarios in manufacturing systems [15]. To investigate the effect of the DPP, a DES model of a real remanufacturing line was created in Siemens Tecnomatix Plant Simulation, and it was also validated using KPIs from one month of production. With the built-in Experiment Manager tool, experiments were performed to investigate the difference between applying or not applying the DPP. The current situation corresponds to the case “Without DPP”. This means that the information on the previous life cycle is only revealed after disassembly and machining – if necessary. In the case “With DPP”, the information is already available before disassembly. This allows the removal of scrap at an earlier stage (marked as “not remanufacturable parts” in 2). As Table 1 shows, the comparison of two scenarios was made based on different system KPIs measured on running one month of production. For each scenario, 15 experiments were performed with the same parameter set but different random seed, and the average of the results are presented in the table.

Surprisingly, the output of the remanufacturing system was reduced a little bit when applying the DPP, and the average lead time was increased. The reason for this is the following: as the scrap rate is lower, the proportion of good products (that are not exiting the system, thus generating lines and slowing the other products down) is higher, causing longer waiting times in the system. In contrast, the number (and ratio) of scrap products was reduced, meaning that in the modelled one month, the approx. 0.6% output decrease came with an approx. 18 % scrap decrease.

**Table 1.** Evaluation of the simulation highlighting the quantitative benefits of a DPP

	Output (pcs)	Avg. lead time	Dev. of lead time	Scrap rate (%)	Scrap prod. (pcs)	New parts (pcs)
Without DPP	1744	6 d 8 h	3 d 19 h	25.31	441.33	159
With DPP	1733	7 d 12 h	4 d 10 h	7.25	125.67	141

## 5 Summary and Future Work

In this paper the remanufacturing uncertainties were presented and it was discussed how the DPP can contribute to a more efficient remanufacturing process. With the help of a simulation model it was illustrated, that the digitization of some product life cycle related information might result in more efficient remanufacturing. The reduced scrap rate and lower number of new parts needed for the end product lead in the end to smaller carbon footprint.

As a next step, lead times and output will be analysed and it will be investigated whether they can be improved with sequencing. In the longer term, the involvement of various stakeholders will be considered. The presented use case might be extended with data on usage (working hours, maintenance, etc.), which could lead to an additional remanufacturing efficiency improvement.

**Acknowledgement.** The authors would like to acknowledge the financial support of the European Commission for funding the H2020 research project EPIC (<https://www.centre-epic.eu/>) under grant No. 739592.

## References

1. Adisorn, T., Tholen, L., Götz, T.: Towards a digital product passport fit for contributing to a circular economy. *Energies* **14**(8), 2289 (2021). <https://doi.org/10.3390/en14082289>
2. Totaro, A.I.: Europe: digital product passport is coming soon, 31 January 2022. <https://www.renewablematter.eu/articles/article/europe-digital-product-passport-is-coming-soon>
3. Barco, C.P., Charnley, F.: Data requirements and assessment of technologies enabling a product passport within products exposed to harsh environments: a case study of a high pressure nozzle guide vane. *Int. J. Prod. Lifecycle Manage.* **8**(3), 253–282 (2015). <https://doi.org/10.1504/IJPLM.2015.074145>
4. Berger, K., Schögl, J.P., Baumgartner, R.J.: Digital battery passports to enable circular and sustainable value chains: conceptualization and use cases. *J. Cleaner Prod.* **353**, 1–15 (2022). <https://doi.org/10.31235/osf.io/e3pmq>. ISSN: 09596526
5. Colicchia, C., et al.: Information sharing in supply chains: a review of risks and opportunities using the systematic literature network analysis (SLNA). *Supply Chain Manage. Int. J.* **24**(1), 5–21 (2019)
6. Company Polestar: Pure, progressive transparency. <https://www.polestar.com/au/news/pure-progressive-transparency/>
7. European Commission: 2030 Digital Compass: the European way for the Digital Decade: Communication from the Commission to the European Parliament, the Council, the European Economic and Social Committee and the Committee of the Regions (2021)
8. European Commission: The European Green Deal: Communication from the Commission to the European Parliament, the European Council, the Council, the European Economic and Social Committee and the Committee of the Regions (2019)
9. N. Gligoric et al.: SmartTags: IoT product passport for circular economy based on printed sensors and unique item-level identifiers. *Sensors* **19**(3) (2019). <https://doi.org/10.3390/s19030586>

10. L.P. Hewlett-Packard Development Company: HP-Environmental History (2020). <https://www8.hp.com/h20195/v2/GetPDF.aspx/c05673165.pdf>
11. Otte, J.N., et al.: An ontological approach to representing the product life cycle. *Appl. Ontol.* **14**(2), 179–197 (2019)
12. Lage, M., Jr., Filho, M.G.: Production planning and control for remanufacturing literature review and analysis. *Prod. Planning Control* **23**(6), 419–435 (2012). <https://doi.org/10.1080/09537287.2011.561815>. ISSN: 0953-7287
13. Kouhizadeh, M., Zhu, Q., Sarkis, J.: Blockchain and the circular economy: potential tensions and critical reactions from practice. *Prod. Planning Control* **31**(11–12), 950–966 (2020). <https://doi.org/10.1080/09537287.2019.1695925>. ISSN: 0953-7287
14. Herrgoß, L., Lohmer, J., Schneider, H., Lasch, R.: Development and evaluation of a blockchain. In: *IEEE International Conference on Industrial Engineering and Engineering Management* (2020)
15. Monostori, L., et al.: Digital enterprise solution for integrated production planning and control. *Comput. Ind.* **61**(2), 112–126 (2010)
16. Luscuere, L.M.: Materials passports: optimising value recovery from materials. *Proc. Inst. Civ. Eng. Waste Resour. Manage.* **170**(1), 25–28 (2017). <https://doi.org/10.1680/jwarm.16.00016>. ISSN: 1747-6526
17. Butzer, S., Schoetz, S.: Map of Remanufacturing Processes Landscape: D3.3 - D3.4 of H2020 Project ERN (2016). [https://www.remanufacturing.eu/assets/pdfs/ERN\\_DeliverableReport\\_WP3\\_Processes\\_final\\_for\\_upload-1.pdf](https://www.remanufacturing.eu/assets/pdfs/ERN_DeliverableReport_WP3_Processes_final_for_upload-1.pdf)
18. Suzanne, E., Absi, N., Borodin, V.: Towards circular economy in production planning: challenges and opportunities. *Eur. J. Oper. Res.* **287**(1), 168–190 (2020). <https://doi.org/10.1016/j.ejor.2020.04.043>. ISSN: 03772217
19. Götz, T., Adisorn, T., Tholen, L.: Der Digitale Produktpass als Politik-Konzept: Kurzstudie im Rahmen der Umweltpolitischen Digitalagenda des Bundesministeriums für Umwelt, Naturschutz und nukleare Sicherheit (BMU) (2021). <https://epub.wupperinst.org/frontdoor/deliver/index/docId/7694/le/WR20.pdf>

**Open Access** This chapter is licensed under the terms of the Creative Commons Attribution 4.0 International License (<http://creativecommons.org/licenses/by/4.0/>), which permits use, sharing, adaptation, distribution and reproduction in any medium or format, as long as you give appropriate credit to the original author(s) and the source, provide a link to the Creative Commons license and indicate if changes were made.

The images or other third party material in this chapter are included in the chapter's Creative Commons license, unless indicated otherwise in a credit line to the material. If material is not included in the chapter's Creative Commons license and your intended use is not permitted by statutory regulation or exceeds the permitted use, you will need to obtain permission directly from the copyright holder.







# Digital Supply Chain Twins for Sustainable Planning of a Logistics System

Simon Zarnitz<sup>(✉)</sup>, Frank Straube, and Benjamin Nitsche

Technische Universität Berlin, Straße Des 17. Juni 135, 10623 Berlin, Germany  
simon.zarnitz@tu-berlin.de

**Abstract.** Digital Supply Chain Twins (DSCT) are gaining more and more attention both in science and in practices. They are considered to be one of the most disruptive technologies in logistics and supply chain management. In the literature, there are a variety of DSCT benefits in the case of planning and control a logistics system. Some of these potentials could also be highly suitable for the use case of sustainable and resource-efficient logistics, which, however, have been insufficiently explored in research so far. This paper will investigate to what extent the DSCT can be used to enable sustainable network planning and which potentials the DSCT implies for the predictive planning within logistics systems. Building on a literature review and interviews with industry experts a case study was conducted at a business partner in the automotive industry.

**Keywords:** Digital supply chain twin · logistics · supply chain · sustainability · planning

## 1 Introduction

Logistics is an interdisciplinary, cross-sectional function that not only enables companies to meet market demand and ensure their long-term success, but also to master future challenges along increasingly complex logistics chains in the long term [1]. In this context, logistics plays a key role, particularly in meeting future climate targets.

Within the context of globalization, there is an increasing spread of manufacturing sites, warehouses and corporate locations, which can on the one hand guarantee cost advantages with lower labor levels or geographical proximity to customers and the respective target market. However, recent crises have been an unprecedented stress test for many international logistics chains [2]. Latest crises have been an unprecedented stress test for many international logistics chains. Above all, the Covid-19 pandemic had a huge impact on future design and the management of logistic networks. Many global value chains have been disrupted by closed factories, ports or airports, leading to longer transport times and lack of resources [3, 4]. The war in the Ukraine and the resulting economic sanctions are another challenge for international value chains. Uncertainty about future energy supplies, the operations of companies in Ukraine and Russia, and shortages of agricultural products are just a few examples [5].

The economic success of a company no longer depends only on the product and the associated processes, but also on the degree of service orientation of the company. Customers will prioritize the company whose offer corresponds to their individual prioritization of the critical success factors of time, cost, quality and flexibility [2].

One of the greatest overall societal, economic and political challenge of recent times has not yet been named: The climate change. Logistics has a crucial function in meeting this challenge by planning and operating sustainable value chains [6].

Besides the ecological aspect, the concept of sustainability is complemented by the economic and social dimensions that need to be addressed in achieving a future-oriented balance in society and the environment. These dimensions considerably increase the complexity of globally grown supply chains [7]:

For more than a century, the critical success factors of quality, cost, time and flexibility dominated global value chains. Through technological advances and digital transformation in companies across all sectors of the economy, logistics systems worldwide have grown so efficient that we are today in an unprecedented state of global prosperity. However, the planet's natural boundaries and limited natural resources are putting a definite end to the constant growth and endless demand for resources. Consequently, the optimization of our systems must take place with equal consideration of sustainability. It is mandatory that the critical success factors be fully complemented by the aspect of ecological sustainability [7].

The growing complexity caused by disruptions and integration of sustainability as an equal success factor can only be implemented with the support of digitalization. On the path to digital transformation in companies, a wide variety of technologies are being discussed, some of them in a concerted manner [8]. The Digital Supply Chain Twin (DSCT) is considered a promising opportunity due to its simulation-based recommendations for action, forward-looking planning and control of global logistics systems. The topic of sustainability cannot only be implemented as a selective optimization of the network, but also requires a collaborative and cooperative approach between different stakeholders within the value network. The DSCT was included in Gartner's Hype Cycle in 2017 and is considered one of the most disruptive technologies in logistics and supply chain management [9].

Scientists have criticized the predominant theoretical research in the field of the digital supply chain twin [10], which is why this paper has examined a case study of a real material flow in the automotive industry. Here, on the basis of historical data, it is conceptually worked out when the DSCT could have predicted a proactive demolition of the delivery capability on the basis of its characteristics (RO1) and which transport routes, which were non-transparent up to this point, can be shown by the created visibility of the network by the DSCT for sustainability assessment (RO2).

## 2 Theoretical Background

### 2.1 Conceptual Clarification of Digital Supply Chain Twins

The primary idea of the concept goes back to NASA's Apollo mission and was further developed by Professor Grieves in the early 2000s [11]. The focus was to predict the behavior of physical objects through simulations and to enable foresighted planning.

Initially, the concept was applied to the product life cycle application domain [12]. In the course of further technical development, the asset-centric approach could be further developed and transferred to entire value creation systems. The paper follows the following definition: “A *digital logistics twin or digital supply chain twin (DSCT)* is a digital dynamic simulation model of a real-world logistics system, which features a long-term, bidirectional and timely data-link to that system. The logistics system in question may take the form of a whole value network or a subsystem thereof.” [10].

The DSCT is therefore a dynamic simulation model, which has 3 unique characteristics that distinguish it from other technologies. The DSCT operates in the long term and can therefore learn from historical data. Additionally, there is a bidirectional data exchange between the real and the digital system. The DSCT’s recommendations for action are based on various simulations, which can be given timely.

## 2.2 Scopes of Digital Twins and Digital Supply Chain Twins

The DSCT has evolved from an asset-centric approach to a systemic scope. To describe the different scopes of the DSCT, the differentiation between DSCT and DT is as follows (Fig. 1):

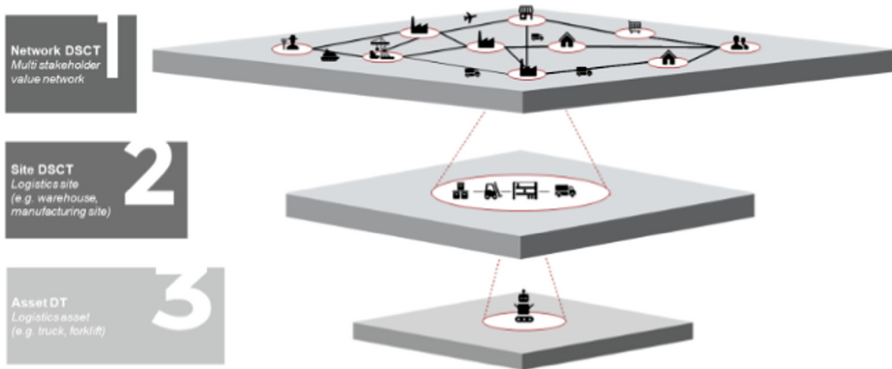


Fig. 1. Scopes of digital twins [13]

The categorization differentiates in particular between Digital Twins and Digital Supply Chain Twins. The Digital Twin refers to the digital representation of assets. In this context, machines or robots can be mentioned, for instance. The Digital Supply Chain Twin is at least a dynamic simulation model of a physical location. This location can be a warehouse, a production site or an infrastructural hub. The most complex DSCT is a dynamic simulation model of an entire network. This includes a wide range of stakeholders.

## 2.3 Planning

This work focuses on the planning of a logistics system. The planning in the sense of this work has the primary goal to fulfill future performance requirements of the system at

any time. For this purpose, the internal processes have to be optimized and the resources should be used accordingly, in order to achieve this at any time. This optimization takes place through the selection, structuring and dimensioning of internal processes. In planning, a distinction is made between medium-term and long-term planning. The long-term planning usually includes the strategic planning, which covers a period of several months up to one year. Due to the lower information density of these periods, the information is uncertain. The accuracy of medium-term planning is correspondingly higher due to a higher information density [14].

### 3 Research Design

The authors first conducted expert interviews in the automotive industry in order to visualize a real supply chain. Furthermore, an explorative case study is conducted with the aim of gaining pre-theoretical insights [15]. Here, an attempt is made to evaluate to what extent the transparency created by the construction of a DSCT helps to assess the system in terms of forward planning and to evaluate when the DSCT could have predicted bottlenecks based on historical data. Consequently, an exploratory-descriptive case study has been conducted. Based on Yin's approach, the case study was planned, executed and evaluated from planning to interpretation [16].

First of all, according to Yin, the *case study* was sufficiently *planned*. The DSCT creates transparency across all flows of goods in the supply chain. Besides the customers and the corresponding sales markets within the network, various stakeholders such as suppliers can be included. The aim of this study is to examine the extent to which the DSCT can be used for the (predictive) planning of logistics systems. This leads to the following research question: What are the potentials of DSCT to predictive and sustainable planning of logistics systems?

In the next step, the case study was *designed*. In order to validate to what extent, the DSCT would have enabled predictive planning, historical data from the year 2020 is used for the case study. The aim is to anticipate possible bottlenecks at an early stage. For this purpose, data sets from suppliers in Africa and South America as well as from the production site and customer orders were requested. Data was collected on inventories, customer orders, forecasted customer orders, supplier backlogs and customer backorders. The aim is to prevent customer backlogs and the associated inability to deliver. As part of this, the *data collection* could be started. In addition to an extensive literature review and expert interviews to visualize the supply chain of the specific case, the datasets outlined above could be pulled from the MySQL database. Each data set was summed up per calendar week to show the interactions. Starting with week 1/2020 until week 52/2020. In order to *analyze* the case study, the data sets were visualized and their interactions in a demonstrative way, these data sets were transferred to a Gantt chart. Bottlenecks could be visualized with different color codes. In this case, the stocks were brought into relation with the reserve stocks and if those were below the safety stock, they were colored red. Additionally, the actual orders from customers were compared with the forecasts to visualize volatile order behavior. In the next step, the network of suppliers, production and customers was visualized on a global map. The goal of this was to make the transport routes completely transparent.

## 4 Discussion of Results

The last steps of the case study according to Yin are the analysis and interpretation of the results. However, caution should always be exercised when generalizing specific results [16].

As a first benefit, the production paths of the product were visualized and transparently presented in consultation with industry experts. A major benefit of the DSCT is that an entire value network from suppliers to customers is visualized and complete transparency is created. This transparency did not previously exist within the practice partner and was developed during the case study at the outset. In this example, the creation of the map was done manually, but should illustrate the benefit of a DSCT which can visualize this map automatically. Thus, irrelevant transport routes could be visualized rather rapidly, which would be restructured in terms of environmental sustainability. A full DSCT with all its characteristics is able to identify the optimal locations in terms of environmental sustainability.

Here, there are not only the movement flows with the facility locations illustrated, but also other data sets about customer demand or inventory policy. The model can thus show vulnerabilities due to long transport routes, for example, at first view. Since the DSCT is continuously supplied with data, disruptions can be identified in this model as soon as they occur. Companies and users are thus able to recognize disruptions at a very early stage and to react to them as efficiently as possible [17–20].

The following product consists of three different components. Two of these components are coming from the African continent, the other one is delivered from South America to Europe. The assembly of the product is a very simple form of manufacturing and requires no special know-how. The customers of the product are mainly in South and Central America. A critical evaluation must be made of the extent to which the network planning can be considered optimal purely for sustainability reasons. A relocation can be done by the simulation capability of the DSCT.

It can be assumed that production site will be relocated by the DSCT to the customer and main sales market. Thus, this could reduce thousands of tons of CO<sub>2</sub> consumed for transport. The network should be critically examined to see whether production could not take place in South America, and the deliveries from South Africa go directly to South America. The company already operates very successful production facilities in South America and the complexity of assembling the final product is not considered complex (Fig. 2).

All in all, this example showed how much value the creation of transparency through a DSCT can create and demonstrates the ecological implementation potential of this technology. Especially for the evaluation of ecological sustainability, the visualization of value chains can quickly make unnecessary transport routes visible. Through simulation-based optimization, the DSCT could simultaneously provide recommendations for further action. (RO2).

The following elaboration is intended to demonstrate the extent to which the DSCT would have enabled predictive planning through its high level of data density. (RO1) During the Corona crisis, bottlenecks occurred several times so that large customer backlogs accumulated because customers could not be supplied. With the help of a Gantt

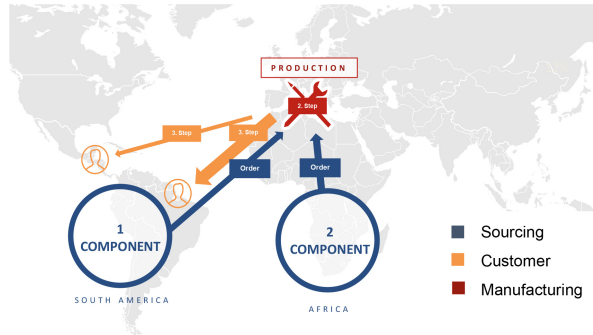


Fig. 2. Transparency (Compiled by author)

chart, it will be shown how a DSCT could have acted as a forward-looking planning tool at an early stage (Fig. 3).

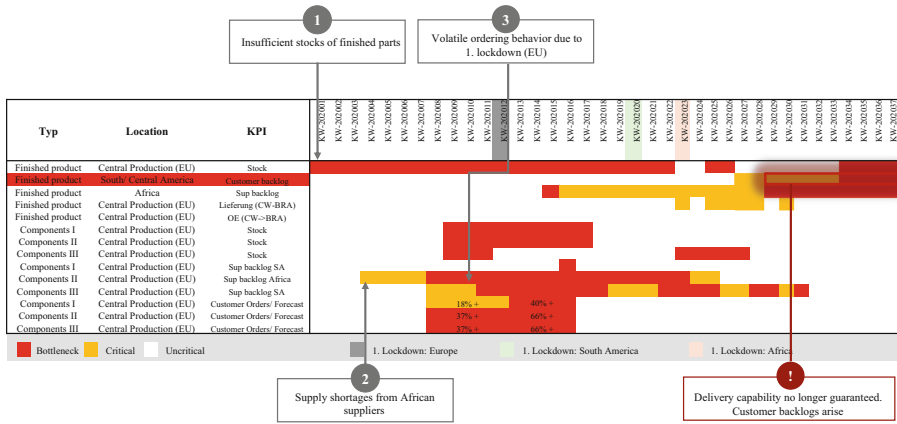


Fig. 3. Gantt chart source: compiled by authors

In the following, a wide variety of data sets were visualized in the form of a Gantt chart to explain the delivery problems starting in calendar week 27 and delivery breakdowns starting in calendar week 34. The goal is to proactively react to such failures through the transparency created by the DSCT. In the following example, three key indicators were shown to what extent the failures could have been detected at an early stage.

- 1) **Insufficient stocks of finished parts:** The European producer already had insufficient parts in stock at the beginning of the year. In this case, the minimum stock level was used as an indicator. Until calendar week 22 there were not sufficient parts in stock.
- 2) **Supply shortages from African suppliers:** Already in the fourth calendar week there were difficulties and pending shortages on 1/3 components, which are necessary for the final product. Such an early allocation of shortages could have been avoided

by an efficient back-up arrangement. From week 8, the supplier from Africa could not deliver the part at all.

- 3) **Volatile ordering behavior due to 1st lockdown:** Due to the corona pandemic already occurring in China at the beginning of the year and the rapid spread in the European region, the 1st lockdown was announced in Europe in calendar week 12. It could be observed that already in the weeks before the lockdown the number of orders increased by about 18–37%. From calendar week 13 (1 week after the 1st lockdown in Europe) the number of orders increased sharply by 40–66%. Based on other previous global crises, it could have been anticipated that a volatile, rapidly increasing demand for parts has occurred regularly in the past.

As the transport takes at least 8–10 weeks from Europe to the customer in Central and South America, it was impossible to have enough parts in stock again from calendar week 23. Due to the long transport distances, the network is not flexible and agile enough to react quickly to the requirements and fulfill the customer order. All in all, a shortage, meaning that the customer order can no longer be fulfilled, was already announced in the 1st quarter of the year, which subsequently began in the 3rd quarter.

The example demonstrates to what extent the DSCT could have predicted a bottleneck occurring in the third quarter. Through data availability, access to different data sources and continuous simulations of various scenarios, the DSCT would have made the insufficient stock of the finished part visible already at the beginning of the year (transparency creation) and simulated possible scenarios to solve the problem (optimization). For instance, by the failure of a necessary component from the 8th calendar week, a DSCT would have found back up suppliers for that part. Finally, the volatile ordering behavior of customers during international crises could have been anticipated, as this phenomenon has been observed in the past in various crises. (RO1).

## 5 Conclusion and Final Remarks

The paper provides an overview of how DSCT can be used for predictive planning to optimizing the ecological sustainability of logistics networks. First of all, the transparency created across the entire value network from suppliers to customers can be used to identify planning errors. In this case, the example can be used to show the extent to which unnecessary transport routes can be identified in this very simple model. Assuming that the network is continuously updated with data from the system (such as data about the ordering behavior of customers, the inventories of suppliers and manufacturing companies, or the demand of customers), conclusions can be drawn about the system at a very early stage.

The DSCT creates a very accurate representation of the current state of the network and simulates possible scenarios through this high data concentration and information from different stakeholders at the network level. Thereby, the network can be optimized and evaluated on the parameter of sustainability. The DSCT offers a space for experiments in which, for example, the network planning can be adapted, transportation modes changed or production techniques modified in order to evaluate the effectiveness of the change in terms of sustainability.

Clear limitations of the work are that no DSCT has been implemented so far. However, it should be understood as a proof-of-concept that DSCT is very suitable for predictive planning and sustainability assessments in production and logistics systems. Additionally, other application fields and possible potentials of DSCTs should be scientifically tested and evaluated. Furthermore, there is a need for research on the technological, process and organizational requirements to implement a DSCT on network level.

## References

1. Busse, A., Gerlach, B., Lengeling, J.C., Poschmann, P., Werner, J., Zarnitz, S.: Towards digital twins of multimodal supply chains. *Logistics*. **5**, 25 (2021). <https://doi.org/10.3390/logistics5020025>
2. Straube, F.: *e-Logistik: Ganzheitliches Logistikmanagement*. Springer, Berlin, Heidelberg (2004)
3. Belhadi, A., Kamble, S., Jabbour, C.J.C., Gunasekaran, A., Ndubisi, N.O., Venkatesh, M.: Manufacturing and service supply chain resilience to the COVID-19 outbreak: Lessons learned from the automobile and airline industries. *Technol Forecast Soc Change*. **163**, 120447 (2021). <https://doi.org/10.1016/j.techfore.2020.120447>
4. Nitsche, B., Straube, F.: Defining the “New Normal in International Logistics Networks: Lessons Learned and Implications of the COVID-19 Pandemic. *WIST*. **50**, 16–25 (2021). <https://doi.org/10.15358/0340-1650-2021-11-16>
5. Liadze, I., Macchiarelli, C., Mortimer-Lee, P., Juanino, P.S.: *The economic costs of the Russia-Ukraine conflict*, 32nd ed. National Institute of Economic and Social Research, London (2022)
6. Abdalla, S.S.A., Nakagawa, K.: Entrepreneurial Leadership, Supply Chain Innovation, and Adaptability: A Cross-national Investigation. *Operations Research Forum* **3**(1), 1–21 (2022). <https://doi.org/10.1007/s43069-022-00135-x>
7. Bergs, T., et al.: (eds.) *Nachhaltige Produktion mit dem Digitalen Zwilling*. Apprimus Verlag, Wissenschaftsverlag des Instituts für Industriekommunikation und Fachmedien, Aachen (2021)
8. Tao, F., Zhang, H., Liu, A., Nee, A.: Digital Twin in Industry: State-of-the-Art. *IEEE Transactions on Industrial Informatics* **24**05–15 (2019)
9. Gartner: *Gartner Top 8 Supply Chain Technology Trends for 2020* (2020). <https://www.gartner.com/smarterwithgartner/gartner-top-8-supply-chain-technology-trends-for-2020/>. Accessed 4 Jan 2021
10. Gerlach, B., Zarnitz, S., Nitsche, B., Straube, F.: *Digital Supply Chain Twins: Conceptual Clarification. Use Cases and Benefits* (2021)
11. Grieves, M.: *Conceptual ideal for PLM.: Presentation for the Product Lifecycle Management (PLM) center* (2002)
12. Grieves, M., Vickers, J.: Digital Twin: Mitigating Unpredictable, Undesirable Emergent Behavior in Complex Systems (Excerpt). In: Kahlen, F.J., Flumerfelt, S., Alves, A.: (eds) *Transdisciplinary Perspectives on Complex Systems*, 85–113 (2017). <https://doi.org/10.13140/RG.2.2.26367.61609>
13. Gerlach, B., Zarnitz, S.: *Typologien und Anwendungsnutzen digitaler Zwillinge in Logistiksystemen: Definition: Der Digitale Logistik Zwilling* (2021). [https://www.logistik.tu-berlin.de/fileadmin/fg2/JPGs/Paxisseminar\\_2021/Typologien-und-Anwendungsnutzen\\_VortragFS.pdf](https://www.logistik.tu-berlin.de/fileadmin/fg2/JPGs/Paxisseminar_2021/Typologien-und-Anwendungsnutzen_VortragFS.pdf). Accessed 26 Apr 2021
14. Gudehus, T.: *Logistik 1*. Springer Berlin Heidelberg, Berlin, Heidelberg (2012)
15. Meyer, J.-A.: *Die Fallstudie in der betriebswirtschaftlichen Forschung und Lehre: WiSt* (2003)



16. Yin, R.K.: Case Study Research: Designs and methods. Sage Publications, California (2003)
17. Ivanov, D., Dolgui, A., Sokolov, B.: Handbook of ripple effects in the supply chain. Springer (International series in operations research & management science), Switzerland (2019)
18. Semenov, Y., Semenova, O., Kuvataev, I.: Solutions for Digitalization of the Coal Industry Implemented in UC Kuzbassrazrezugol. E3S Web Conf. **174**, 1042 (2020). <https://doi.org/10.1051/e3sconf/202017401042>
19. Barykin, S.Y., Bochkarev, A.A., Kalinina, O.V., Yadykin, V.K.: Concept for a Supply Chain Digital Twin. Int J Math, Eng, Manag Sci. **5**, 1498–1515 (2020). <https://doi.org/10.33889/IJMEMS.2020.5.6.111>
20. Marmolejo-Saucedo, J.A.: Design and Development of Digital Twins: a Case Study in Supply Chains. Mobile Networks and Applications, 2141–60 (2020). <https://doi.org/10.1007/s11036-020-01557-9>

**Open Access** This chapter is licensed under the terms of the Creative Commons Attribution 4.0 International License (<http://creativecommons.org/licenses/by/4.0/>), which permits use, sharing, adaptation, distribution and reproduction in any medium or format, as long as you give appropriate credit to the original author(s) and the source, provide a link to the Creative Commons license and indicate if changes were made.

The images or other third party material in this chapter are included in the chapter's Creative Commons license, unless indicated otherwise in a credit line to the material. If material is not included in the chapter's Creative Commons license and your intended use is not permitted by statutory regulation or exceeds the permitted use, you will need to obtain permission directly from the copyright holder.





# Optimization of a Remanufacturing Production Planning System with the Help of Artificial Intelligence

Barna Gal<sup>1</sup>(✉), Viola Gallina<sup>1</sup>,  Szaller<sup>2</sup>, and Sebastian Schlund<sup>1,3</sup>

<sup>1</sup> Fraunhofer Austria Research GmbH, Theresianumgasse 7, 1040 Wien, Austria  
barna.gal@fraunhofer.at

<sup>2</sup> EPIC InnoLabs, Kende str. 13-17, Budapest, Hungary

<sup>3</sup> Technische Universitt Wien, Institute of Management Science,  
Theresianumgasse 27, 1040 Wien, Austria

**Abstract.** Although production planning in remanufacturing systems has attracted great interest from the research community, only a couple of real industrial applications can be perceived. Additionally, in real cases, companies are faced with manufacturing multiple products, which further complicates remanufacturing production planning (RPP). Therefore, there is a need to optimise RPP where manufacturers are involved in remanufacturing multiple products. Also optimized systems should consist of a number of uncertainties, such as the uncertain quality of the returned products.

Because of these uncertainties the manufacturers have to use new parts or components - with both higher environmental impacts, as well as costs. In the present paper a line balancing scheduler of a remanufacturing system is presented - focusing on the disassembly, machining and reassembly of parts. The objective of the paper is the reduction of usage of the energy and cost intensive new parts with production scheduling using a genetic algorithm (GA). The achievements are illustrated and presented with a real industrial use case from a gas engine producer. A discrete event simulation (DES) is used for evaluation purposes and the results from the scheduler are compared with benchmarks of the current production planning of the gas engine manufacturer.

**Keywords:** remanufacturing · genetic algorithm · production planning · simulation · uncertainties

## 1 Introduction

Humanity currently requires the equivalent of 1.7 planets to compensate for resource consumption by human activities [17]. Furthermore the manufacturing industry is one of the main consumers of material and energy resources, in addition to generating significant amounts of waste. Due to the scarcity of resources, the concept of circular economy based on remanufacturing has become an important approach for resource-efficient sustainable development, representing one of

the most significant aspects of waste management [15]. Remanufacturing is most commonly referred to as a recovery process for used products that involves the collection, repair, disassembly, and replacement of worn-out components to bring the products back to the quality level of newly manufactured products [14]. In remanufacturing, there are particular challenges for production planning systems (PPS) that do not exist in traditional manufacturing [1]. These characteristics, unique to remanufacturing, require a change in the fundamental concept of traditional PPS [4].

### 1.1 Motivation of This Research

To highlight the research gaps within RPS systems for this paper, the identified research needs from two literature reviews are used. For example, in an analysis of 160 scientific journal publications, Suzanne et al. [14] state that although from an academic perspective RPS have attracted a lot of interest, but only weak links with industrial applications can be perceived. In addition, Ansari and Daxini [2], in an analysis of 123 scientific journal publications, point out that in real cases, companies are faced with manufacturing multiple products, further complicating remanufacturing production planning. Therefore, they call for future research to optimize RPS in a way, that manufacturers are involved in remanufacturing multiple products and the system consists of a number of uncertainties, such as uncertain quality, time, return, and demand [2]. In addition to the research needs from academia, those challenges presented in [1] can be observed in a remanufacturing plant for gas engines. The uncertain timing as well as the quality and reusability of the recirculated components and assemblies pose the problem to the manufacturer that the regular use of energy- and cost-intensive new parts has to be accepted. From the above findings, the central research question for this paper results in how the use of a genetic algorithm can minimize the use of energy and cost intensive new parts through production schedule sequence optimization. The main objective of this work is to develop an approach to optimize RPS, taking into account the uncertain quality of the returned products as well as the diversity of variants. Subordinately, this work attempts to remedy the above-mentioned research gaps of Suzanne et al. [14] and Ansari and Daxini [2] by developing a procedure with stronger connections to industrial applications and by incorporating uncertainties from reality into the optimization.

The paper is structured as follows. First, a literature review is presented regarding RPS and the addressed research gaps are discussed. The following chapter deals with the method description and the research question. Then the simulation model is introduced that is used to evaluate the genetic algorithm, which was designed to optimize the production plan sequence of the company partner.

## 2 Literature Review

### 2.1 State of the Art

Research activities in the field of PPS for remanufacturing often focus on *disassembly planning* and scheduling. Jeunet and her coauthors present an approach for solving practical sequencing problems [8]. Lage Junior and Godinho Filho [9] propose a stochastic dynamic programming model considering stochastic routings. They apply their model to a real case of automotive clutch remanufacturing. Mao et al. [11] combine genetic algorithm with Petri net modeling and stochastic programming for used car parts under uncertain conditions. Wang presents a parallel partial disassembly line balancing model with stochastic disassembly time [16]. In the paper of Rent et al. the desassembly planning is extended with end-of-life consideration aiming at the maximization of the recovered value [13].

*Hybrid systems* that use both raw materials and returned products in the production process are often addressed in the literature as well. Fang [5] optimizes the operation strategy (determining the amount of new and remanufactured products) considering the related costs, uncertainty about recycling, demand substitution, capacity limitations and component durability. Han and his coauthors [7] focus on uncertainties of quality, process times, remanufacturing costs as well as market demands and using robust optimization. Polotski et al. [12] concentrate on manufacturing and remanufacturing costs, holding costs, backlog and set-up costs. Benkherouf et al. investigate an inventory system with production, remanufacturing and refurbishing activities using mathematical programming [3].

## 3 Methods

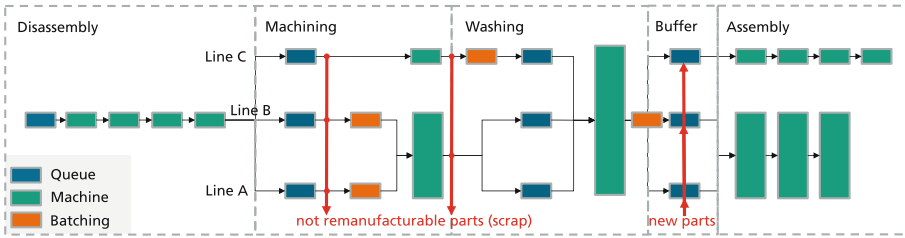
The procedure in this research was divided into five steps, which includes problem identification, goal definition, development, demonstration, evaluation, and publication. The focus is on the development and demonstration, in which the GA is adapted for the use case and coupled with the simulation. The exact implementations of the research steps can be seen in Table 1.

## 4 Simulation Model of a Real Remanufacturing Application

In an remanufacturing shop, cast housings of returned cylinder heads are basically disassembled, machined, and reassembled after reaching end-of-life status. The remanufactured cylinder heads, which are an essential part for gas engines, can be used for a maximum of three product life cycles. The two-shift cylinder head production system specialized in refurbishment with several disassembly, machining, storage and assembly stages is designed as a simulation in a multi-line discrete event simulation (DES) model after [6], which is run through by a work piece agent population, shown in Fig. 1

**Table 1.** Conceptual Framework for this research after Pfeffers et al. (2007)

Steps from Pfeffer et al. (2007)	Implementation
i) problem identification and motivation	RPS have only weak links with industrial
ii) defining goals for a solution	Applications and to optimize RPS such that manufacturers are involved in remanufacturing multiple products and the system consists of a number of uncertainties, such as uncertain quality
iii) designing and developing	Usage reduction of energy and cost intensive New parts of an industrial remanufacturer
iv) demonstrating	Constrain a GA for the given industrial use case
v) evaluating and publishing	Implementing and validating GA in Python with Anylogic simulation
	Evaluate GA with simulation and publish findings

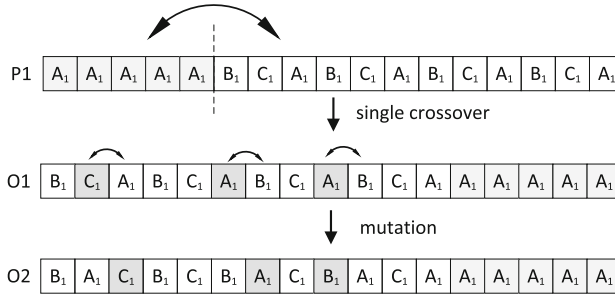
**Fig. 1.** Flowchart and simulation model

In order to follow the call of Ansari and Daxini [2] and to optimize RPS in such a way that different product variance and a system with different uncertainties are taken into account, the population within the agent is defined with different influencing factors, such as series, product variants, production times. The DES that the agents run through acts with the uncertainties of the reject rate, which varies randomly per series and station, as it was measured in reality. The exact used agent parameters and system parameters can be found in Table 2.

The evaluation of the simulation is carried out by means of a monthly production plan of the company partner. The total number of assembled cylinder heads at the end of the month are known, as well as the number of units of which variants were assembled and the sequence in which the lines are planned. The sequence is done in always alternating push into the lines (as an example:  $A_1, B_1, C_1, A_2, B_2, C_2, A_3, \dots$ ). The simulation needed 22 h (4,44% deviation) more, then the real remanufacturer (496 h), whereby a start-up time of the simulation must be taken into account, i.e. the filling up of the lines. This small difference validates the DES model.

**Table 2.** Agent and system parameters of the simulation

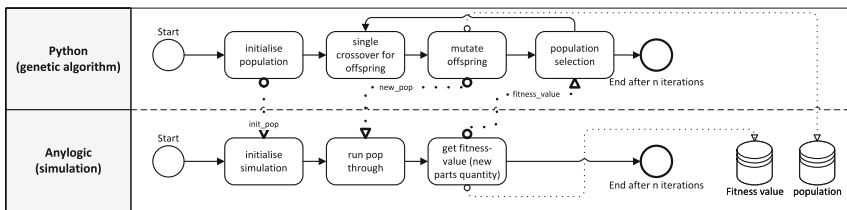
Cylinder head variant	$A_1$	$A_2$	$A_3$	$B_1$	$B_2$	$B_3$	$C_1$	$C_2$	$C_3$	$C_4$	$C_5$
Quantity	$n_{A1}$	$n_{A2}$	$n_{A3}$	$n_{B1}$	$n_{B2}$	$n_{B3}$	$n_{C1}$	$n_{C2}$	$n_{C3}$	$n_{C4}$	$n_{C5}$
Machining time	$t_{m,A1}$	$t_{m,A2}$	$t_{m,A3}$	$t_{m,B1}$	$t_{m,B2}$	$t_{m,B3}$	$t_{m,C1}$	$t_{m,C2}$	$t_{m,C3}$	$t_{m,C4}$	$t_{m,C5}$
Assembly time	$t_{a,A1}$	$t_{a,A2}$	$t_{a,A3}$	$t_{a,B1}$	$t_{a,B2}$	$t_{a,B3}$	$t_{a,C1}$	$t_{a,C2}$	$t_{a,C3}$	$t_{a,C4}$	$t_{a,C5}$
Scrap rate	$srd_A$	$srd_A$	$srd_A$	$srd_B$	$srd_B$	$srd_B$	$srd_C$	$srd_C$	$srd_C$	$srd_C$	$srd_C$
After disassembly											
Scrap rate	$srm_A$	$srm_A$	$srm_A$	$srm_B$	$srm_B$	$srm_B$	$srm_C$	$srm_C$	$srm_C$	$srm_C$	$srm_C$
after machining											



**Fig. 2.** How the GA changes from population to population

### 5 Optimization

The GA is designed in [6] following [10] and adapted to this use case. Here one population is used, which presents one monthly production plan and has single crossover and mutation (with a mutation rate of 10% as possibilities to change from population to population each iteration like it is described in [10] and shown in Fig. 2. While single crossover causes a heavy change in the sequence, which can lead to overlooking present minima, it is only used every tenth iteration, if no new minima was found.



**Fig. 3.** Communication between simulation and GA

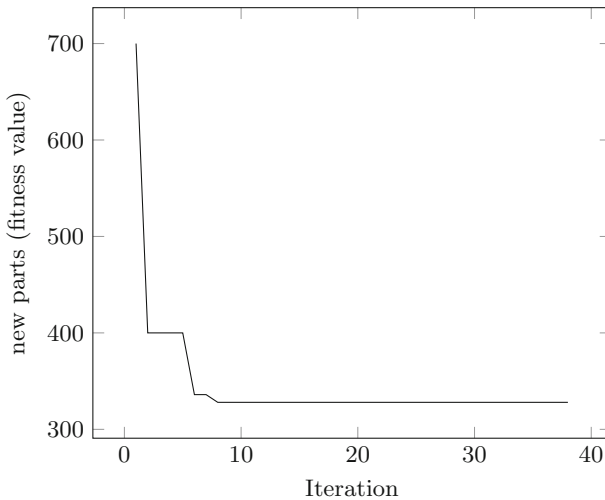
For evaluation of the GA, Python is connected to the simulation software Anylogic through the add-on library Pypline, where Anylogic acts as a mainframe and calls and runs function codes from Python. To run the optimization exactly, Python starts by initializing a random population representing a monthly schedule, as provided by the company partner, in random production order. The initialized population is run through the simulation in Anylogic to obtain the first fitness value, which represents the number of new parts needed. After single crossover and a mutation of the offspring population is triggered by Python, a new run of the new population through the simulation is performed, in order to get a new fitness value. With population selection the fitness values are compared and lowest one is used as new population for the next iteration, till a given number of maximum iteration is reached, as it is shown in Fig. 3.

## 6 Results and Limitations

As visible in Table 3, the sequence optimization of the production plan by the GA results in a decrease of 44.41% of required new parts compared to the real

**Table 3.** Results of the GA highlighting the quantitative benefits in comparison

	$A_{new}$ (pcs)	$B_{new}$ (pcs)	$C_{new}$ (pcs)	$A_{old}$ (pcs)	$B_{old}$ (pcs)	$C_{old}$ (pcs)	$Sum_{month}$ (pcs)	$Sum_{new}$ (pcs)
Real use case	200	240	150	480	220	620	1910	590
Simulation	200	240	150	480	220	620	1910	590
GA	136	136	56	622	326	620	1916	328



**Fig. 4.** Fitness value course of the GA per iteration

use case and the simulation. However, a slower cycle time is expected since the GA was compared with the 4.44% slower simulation. An upper limit of available cast housings for machining, as is the case in reality, was not introduced for this simulation in order to be able to determine the maximum production capacity of the lines.

In Fig. 4 the fitness value improvement of a total of 38 iterations of the GA is shown. It is to be expected that by further GA fine tuning and increasing the number of iterations (this was limited by the Personal Learning Edition (PLE) restriction of Anylogic) further minima can be found, which undercut the value of this research.

## 7 Conclusion

To address the research gaps within RPS, which show weak links to industrial applications and a lack of optimization with multiple products and multiple uncertainties, a GA optimization with coupled DES is presented and applied to an industrial use case. This approach considers a number of parameters related to the product variance (such as different duration in disassembly, machining and assembly) and uncertainties (such as different scrape rates for each variant) of the RPS. An overall improvement of the cost- and energy-intensive new parts requirement of 44.41% can be achieved. As a next step the environmental impacts of the new and old parts and their optimization will be investigated. On longer term other optimization methods like ant colony optimization, simulated annealing and grey wolf optimization will be tested as well.

## References

1. Andrew-Munot, M., et al.: Analysis of production planning activities in remanufacturing system. *J. Mech. Eng. Sci.* **12**(2), 3548–3565 (2018)
2. Ansari, Z.N., Daxini, S.D.: A State-of-the-art review on meta-heuristics application in remanufacturing. *Arch. Comput. Methods Eng.* **232**(20),1465 (2021). ISSN: 1134-3060
3. Benkherouf, L., Skouri, M., Konstantaras, I.: Optimal control of production, remanufacturing and refurbishing activities in a finite planning horizon inventory system. *J. Opti. Theory Appli.* **168**(2) 677–698 (2016)
4. Y. Cui et al. Research on remanufacturing scheduling problem based on critical chain management. In: *IOP Conference Series: Materials Science and Engineering* 215 (2017), p. 012005
5. Fang, C., Lai, M., Huang. Y.: Production planning of new and remanufacturing products in hybrid production systems. *Comput. Indust. Eng.* **108**(4), 88–99 (2017). ISSN: 03608352
6. Gal. B.: Study on application-oriented sequence optimization for remanufacturing production planning systems in the circular economy. *Tech nische Universität Wien* (2022)
7. Han, S.A., et al.: A robust optimisation model for hybrid remanufacturing and manufacturing systems under uncertain return quality and market demand. *Int. J. Prod. Res.* **54**(17), 5056–5072 (2016) ISSN: 0020-7543



8. Jeunet, J., Croce, F., Salassa. F.: Heuristic solution methods for the selective disassembly sequencing problem under sequence-dependent costs. In: IFAC PapersOnLine , pp. 52–13 (2019)
9. Lage, M., Jr., Godinho Filho, M.: Master disassembly scheduling in a remanufacturing system with stochastic routings. *Cent. Eur. J. Oper. Res.* **25**(1), 123–138 (2017)
10. Li, W., Wang, S.: *Sustainable Manufacturing and Remanufacturing Management*. Springer, Cham (2019). <https://doi.org/10.1007/978-3-319-73488-0>. ISBN: 978-3-319-73487-3
11. Mao, J., et al.: Disassembly sequence planning of waste auto parts. In: *J. Air Waste Manag. Assoc.* **71**(5) , 607–619 (2021)
12. Polotski, V., Kenne, J., Gharbi. A.: Set-up and production planning in hybrid manufacturing-remanufacturing systems with large returns. *Int. J.f Prod. Res.* **55**(13), 3766–3787 (2017). ISSN: 0020–7543
13. Ren, Y., et al.: A Multiobjective disassembly planning for value recovery and energy conservation from end-of-life products. In: *IEEE Transactions on Automation Science and Engineering* 1vol. 8, pp. 791–803 (2021)
14. E. Suzanne, N. Absi, and V. Borodin. Towards circular economy in production planning: Challenges and opportunities. *Eur. J. Oper.l Res.* **287**(1) , 168–190 (2020). ISSN: 03772217
15. VDI Zentrum Ressourceneffizienz. Studie VDI ZRE: Potenziale der schwachen künstlichen Intelligenz für die betriebliche Ressourceneffizienz. (2021)
16. K. Wang and Li. A genetic simulated annealing algorithm for parallel partial disassembly line balancing problem. *Appl. Soft Comput.* **107**(11) 107404. (2021), ISSN: 15684946
17. WWF. EU overshoot day living beyond nature’s limits, World Wide Fund for Nature. 2019. url: [https://www.wwf.at/de/view/les/download/showDownload/?tool=&feld=&sprac\\_hconnect=3371](https://www.wwf.at/de/view/les/download/showDownload/?tool=&feld=&sprac_hconnect=3371)

**Open Access** This chapter is licensed under the terms of the Creative Commons Attribution 4.0 International License (<http://creativecommons.org/licenses/by/4.0/>), which permits use, sharing, adaptation, distribution and reproduction in any medium or format, as long as you give appropriate credit to the original author(s) and the source, provide a link to the Creative Commons license and indicate if changes were made.

The images or other third party material in this chapter are included in the chapter’s Creative Commons license, unless indicated otherwise in a credit line to the material. If material is not included in the chapter’s Creative Commons license and your intended use is not permitted by statutory regulation or exceeds the permitted use, you will need to obtain permission directly from the copyright holder.





# Circular Supply Chain Management in the Wind Energy Industry – A Systematic Literature Review

Kathrin Julia Kramer<sup>(✉)</sup>  and Matthias Schmidt 

Institute of Product and Process Innovation, Leuphana University, 21335 Lüneburg, Germany  
kathrin.kramer@leuphana.de

**Abstract.** The shift to a circular economy and the use of wind energy are key components in achieving the climate goals that some governments like Germany have set for themselves. Nevertheless, the wind energy industry is still predominantly organized as a linear system. Therefore, this paper outlines the existing research on the wind energy supply chain and embeds it in the context of a circular economy. The results show that some aspects of the circular economy have recently gained attention. For instance, the recycling of wind turbine blades is often discussed in literature. However, circular thinking is still underrepresented in supply chain management research. For example, studies on return, recover and deliver processes are rare. By presenting a structured overview of the current state of research, an agenda for future investigations can be derived. Hence, this publication makes a clear contribution towards becoming more circular in the wind energy supply chain.

**Keywords:** Circular Supply Chain Management · Sustainability · Circular Economy · Wind Energy · Literature Review · Supply Chain Management

## 1 Introduction

Circular Economy (CE) is a system changing concept that could contribute to a more sustainable and resilient supply chain management (SCM) [1–3]. With an increasing frequency of disruptions with growing amplitudes a sustainable and resilient SCM becomes even more relevant [4]. A standard definition of CE does not yet exist, this paper follows the definition by Kirchherr et al. [5]. They define CE as a multi-level system changing concept that is based on business models with value obtaining strategies following a cascade – Reduce, Reuse, Recycle and Recover – and contributing to a sustainable development [5]. Embedding the circular thinking into SCM is stated as Circular Supply Chain Management (CSCM) [6].

Due to the expected benefits, CE is recently gaining attention in SCM practice (e.g. furniture industry, automotive industry, construction) and research [3, 6–8]. Nevertheless, investigations in regards to the wind energy SCM are still rare. Despite, research in this field is of importance as the industry mostly operates in a linear system. Ambitious climate laws by governments trigger an expansion of the industry that will also

lead to increased waste volumes if not reflecting circular thinking [9]. The size of wind turbines and their components, as well as the decentralized geographical distribution of wind turbines, underscore the role of SCM in promoting a CE [10]. Hence, this paper investigates how the current literature on SCM in the wind energy industry is structured and if a link to CE exists.

## 2 Current State of Research

As highlighted in Sect. 1, applying CSCM in the wind energy industry has several potential benefits. Nevertheless, research on this topic is rare. This section with Table 1 provides an overview of relevant research and outlines the contribution of this review.

**Table 1.** Differentiation from existing research

Source	SCM	Onshore wind	Offshore wind	CE	SLR
[11]			x	x	
[12]		X	x	x	
[13]		(x)	x	x	x
[14]	(x)	(x)		(x)	
[15]	(x)	(x)	(x)	(x)	(x)
[16]	(x)	(x)		(x)	
[17]	(x)	(x)	(x)	(x)	
[18]	(x)	(x)	(x)	x	
[19]	x			x	x

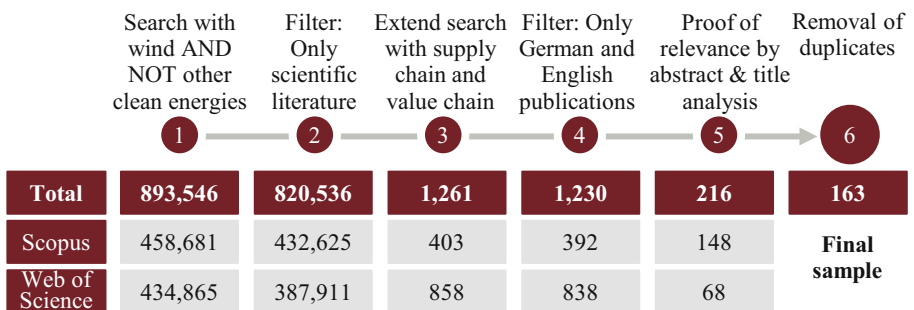
Jensen et al. [11] point out the need to embed CE in clean energy infrastructure by looking at offshore wind energy (offshore wind) in the United Kingdom (UK). They provide insights about strategies for the end-of-life (EoL) for rare earth elements, copper and composites. In another publication [12], Jensen et al. concentrate on remanufacturing of three case studies as of one is from the wind energy industry. Different economic, ecological and social factors through remanufacturing from the perspective of a wind turbine manufacturer are presented. Velenturf [13] develops a framework for integrating a sustainable CE in offshore wind. 18 CE strategies (e.g. dematerialise, repair, reuse) are stated for materials, components and infrastructure for offshore wind. She proposes to apply this framework to other energy infrastructure such as onshore wind energy (onshore wind) [13]. Nevertheless, these studies do not cover SCM aspects. Some researchers have investigated CSCM aspects in relation to wind turbine blades: For instance, Rentizelas et al. [14] examine the reverse supply network design for waste volumes from wind turbine blades in Europe. The analysis reflects on environmental and economic aspects and proposes a semi-decentralised network design with 3–4 facilities in Europe. Beauson et al. [15] provide a holistic view on the EoL-related processes of wind turbine blades and discuss potential waste volumes, the legislation and standards as well as technical

processes in an European context. Nagle et al. [16] conduct a life cycle assessment of three repurposing scenarios for the second use of decommissioned wind blades from onshore wind in Ireland. Lapko et al. [17] focus on critical raw materials for photovoltaic panels and wind turbines and influencing factors to enable a closed-loop supply chain (SC). Koumoulos et al. [18] present a roadmap for challenges and practical applications for the composites industry. And finally, Franco et al. [19] conduct a systematic literature review (SLR) on the photovoltaic SC in the light of a CE.

Thus, none of the presented studies take a holistic view on the wind energy SC while embedding the concept of a CE. So far, no SLR on CSCM in relation to the wind SC exists. However, for example Farooque et al. [6] call for industry-specific research as a result of their review on CSCM literature. In addition, as CE is a system-wide approach it is of importance to gather a complete picture. This paper aims at closing the research gap by answering the research question: “*What is the current state of research on wind energy SCM and which links to a CE exist?*”. With conducting a SLR a basis to derive research trends and gaps is set.

### 3 Research Methodology

The research methodology of this paper consists of identifying a representative sample of literature on the wind energy SCM and of analyzing this sample in regards to its reference to a CE. The SLR process is based on Tranfield et al. [20] as the process is known to gather knowledge within scientific literature and to enable a holistic view. The procedure was already used in CSCM [19, 21]. Using the established databases Scopus and Web of Science [22], the SLR was conducted between 21/03/2022 and 12/05/2022. As also summarized in Fig. 1, the review process consists of six steps.



**Fig. 1.** Search process of the scientific literature review

The research is conducted by applying the following search string to titles, abstracts and keywords: (“supply chain\*” OR “value chain\*”) AND (“wind”) AND NOT (“pv” OR “solar” OR “photovoltaic\*” OR “biomass” OR “biofuel” OR “biogas” OR “hydro”). The research string follows the assumptions of Franco et al. [19] and Velenturf [13]. Franco et al. used “supply chain\*” and “value chain\*” and excluded other energy sources such as biomass to identify papers purely on photovoltaic in their case. This approach is

applied for the case of wind energy in this publication. However, not “wind\*” is used, but instead “wind” as done by Velenturf as “wind\*” results in too many not related results. In contrast to Velenturf, the search does not include terms on CE, as CE has not yet fully migrated into the SCM and would eventually lead to overlooked publications [13, 21]. To underpin, a search on Scopus on 21/03/2022 with the search string TITLE-ABS-KEY (“wind”) AND (“circular\*”) AND (“value chain\*” OR “supply chain\*”) led to 19 publications from 2013–2022.

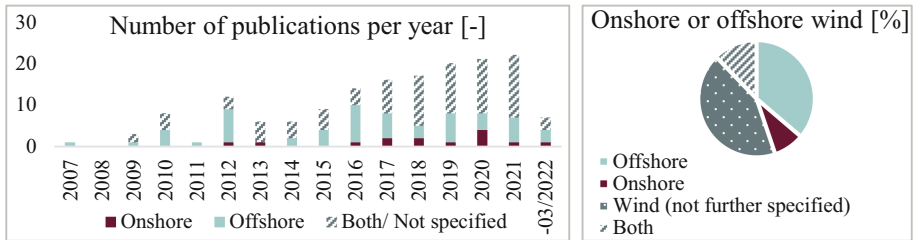
A search with “wind” initially leads to 893,546 publications on Scopus and Web of Science. In a second step the literature is filtered to only scientific literature, journal and conference papers. Next, the search string is supplemented by “value chain\*” and “supply chain\*”, resulting to 1,261 scientific publications. In the fourth step, only German and English articles are selected and in the fifth step, the title and abstract of each article is checked for relevance for the objective of this paper. Thus, only articles are selected that have a linkage to the wind energy industry and to SCM. To limit the boarder of the investigation, papers that only thematize power trading, offsetting, balancing or energy storage and transport (e.g. grid) are excluded. The focus is on the wind turbine SC with its components and materials. Also, market studies and studies purely focusing on technical design are left out. The sixth step, removes duplicates between the chosen databases. Finally, a representative sample of 163 scientific publications on the wind energy SCM is considered as the body of analysis. For 122 paper a full-text is available and for 41 papers only the abstract. The content of the abstract is sufficient for conducting the analysis, otherwise they would have been excluded.

The analysis of the 163 articles foresees to first describe the sample regarding the publication year and secondly, a content analysis takes place. The object of research is characterized: material, component, wind turbine/ wind farm in onshore or offshore wind [13]. Materials for wind turbines are concrete, steel, electronical components (with its rare earth materials neodymium and dysprosium), copper, aluminum, polyvinyl chloride (PVC), operating fluids, composites (glass-fibre reinforced plastic (GFRP) and carbon-fiber reinforced plastic (CFRP)) [10, 23]. Out of those, the key components – foundation, tower, rotor blades, rotor hub, nacelle, generator, gearbox, grid connection technology – arise [10, 24]. Finally, the wind turbine and wind farm is assembled [13]. For a geographical classification, the region of investigation is stated. Finally, following Vegter et al. [25], the publications are classified according to an adapted SCOR model: Plan, Source, Make, Deliver, Use, Return, Recover, and Enable. The authors have extended the common and industry-neutral framework with the processes Use and Recover to promote CE. Hence, they extract recycling and remanufacturing from the process Make to Recover and repair and maintenance from the process Make to Use [25]. The model is already used by other researchers in CSCM [1, 26].

## 4 Results

This section presents the results of the applied research methodology that led to 163 scientific publications about the wind energy SCM since 2007. When comparing to SCM in general with its first mentioning of the term in 1982 and even earlier research on some aspects, it is still a young research field [4]. As shown in Fig. 2, it is astonishing

that offshore wind has a longer track record as onshore wind was established to the market prior to offshore wind [10]. In total 8.6% of the articles focus on onshore wind, 36.2% on offshore wind and the remaining 55.2% did not specify or addressed both types. Authors who did not specify the field could possibly mean onshore, since the field is more mature. Otherwise, the research interest on offshore wind's SCM could be due to the logistical and manufacturing complexity of maritime operations [10, 27].



**Fig. 2.** Number of publications per year and wind energy offshore or onshore

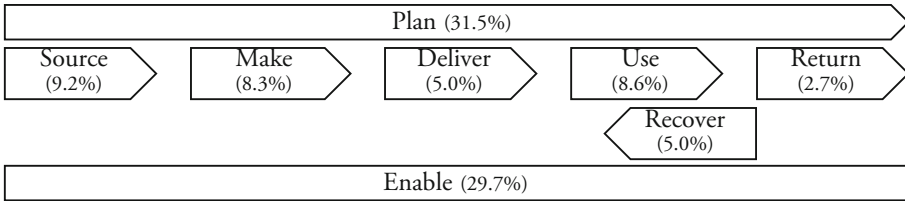
Next, the investigated region and object of research are presented in Fig. 3. 31.9% of articles from the sample address Europe, 12.7% Asia-Pacific, 12.7% Americas, 3.0% Africa and Middle East and 39.8% were not classified or have a global scope. In Europe mostly Germany (12 articles) and the UK (8 articles), in Asia-Pacific predominantly China (18 articles) and in Americas mainly the United States of America (USA, 14 articles) were studied. China, USA and Germany are the biggest onshore markets that could eventually explain the research interest [10]. Europe being the largest offshore market, could justify why 49.2% of offshore wind research is located in this region [10]. Figure 3 also illustrates that 6.7% of the identified articles deal with materials, 27.6% with components and 65.6% with the wind turbine/ farm.



**Fig. 3.** Number of publications per region and object of investigation

Only rare raw materials that are used for permanent magnets generators are represented in the sample. The research interest could be due to its high uncertainties on pricing and availability as supplier countries and mines are rare [10]. Research on key components mainly focus on blades and secondly on the generator and foundation. The publications on the foundation purely cover offshore wind. This could be due to the high technical requirements on the stability to cope with the extreme weather conditions [10, 24]. Most papers however address several components (e.g. spare parts). Finally, the

sample is clustered according to examined processes as presented in Fig. 4. Most articles deal with the processes Plan (31.5%) and Enable (29.7%). Followed by Source (9.2%), Use (8.6%) and Make (8.3%). The results indicate that the wind SCM literature focuses on these processes. Studies on Return (2.7%), Recover (5.0%) and Deliver (5.0%) are less represented in research. In the sample, some papers show a link to CSCM and sketch aspects of reducing, reusing, recycling and recovering materials and components.



**Fig. 4.** Final sample of scientific articles clustered according covered processes [25]

For instance, Menzel et al. [28] cover the Plan process and discuss the benefits of modularization for a German manufacturer. Mert et al. [29] reflect on product-service systems for onshore wind. Bonfante et al. [30] outline strategies for rare earth magnets production and analyze CE strategies. Cheramin et al. [31] design the reverse SC for rare earth magnets in the USA and Rentizelas et al. [14] for blades in Europe.

## 5 Conclusion and Future Research Agenda

This work has identified and characterized a representative sample of scientific literature on wind energy SCM. Insights into the year of publication and covered regions, products and processes were given. First CE links are outlined that could form the basis for further research: For example, a systematic CSCM design of the macro, meso and micro levels and its dependencies on different objectives could be of interest. To be able to handle the complexity while reflecting the entire lifecycle of a wind turbine, a regional focus (e.g. on Germany) could be beneficial. Then also specific market and policy conditions can be considered. Modelling the resource flows and characteristics would increase transparency and could enable the identification of viable circular business models and SC design. As CE relies on a system change, the enabling processes (e.g. technology, cooperation) also play an important role. The paper’s results indicate, that some CE strategies were addressed, but still rarely. Thus, researchers should continue to analyze the link of CE strategies and existing research on wind energy SCM. This counts for onshore and offshore, the material, component and infrastructure perspective and different regions. In this context, further empirical studies are needed that examine the effects on the three dimensions of sustainability as well as resilience. For instance, as turbines increasingly reach their EoL, research on reuse and recycle is required. Hence, a reverse SC and sufficient business models should be explored and lessons learned should be reflected in the design of new wind turbines. All in all, CSCM should enable to reduce, reuse, recycle and recover materials, components and turbines for keeping the highest possible value. To achieve this, the SC, company, products and processes levels have to be considered.

**Acknowledgements.** Funded by the Lower Saxony Ministry of Science and Culture under grant number ZN3489 within the Lower Saxony “Vorab” of the Volkswagen Foundation and supported by the Center for Digital Innovations (ZDIN).

## References

1. Chaouni Benabdellah, A., Zekhnini, K., Cherrafi, A.: Sustainable and Resilience Improvement Through the Design for Circular Digital Supply Chain. In: Dolgui, A., Bernard, A., Lemoine, D., von Cieminski, G., Romero, D. (eds.) APMS 2021. IAICT, vol. 633, pp. 550–559. Springer, Cham (2021). [https://doi.org/10.1007/978-3-030-85910-7\\_58](https://doi.org/10.1007/978-3-030-85910-7_58)
2. Ellen MacArthur Foundation: Completing the Picture: How the Circular Economy Tackles Climate Change (2019). [www.ellenmacarthurfoundation.org](http://www.ellenmacarthurfoundation.org). Accessed 21 February 2022
3. Negri, M., Cagno, E., Colicchia, C., Sarkis, J.: Integrating sustainability and resilience in the supply chain: a systematic literature review and a research agenda. *Bus Strat Env* **30**(7), 2858–2886 (2021)
4. Stadtler, H.: Supply Chain Management and Advanced Planning: Concepts, Models, Software, and Case Studies, p. 572. Springer, Dordrecht (2007)
5. Kirchherr, J., Reike, D., Hekkert, M.: Conceptualizing the circular economy: An analysis of 114 definitions. *Resour. Conserv. Recycl.* **127**, 221–232 (2017)
6. Farooque, M., Zhang, A., Thürer, M., Qu, T., Huisingsh, D.: Circular supply chain management: A definition and structured literature review. *J. Clean. Prod.* **228**, 882–900 (2019)
7. de De Angelis, R., Howard, M., Miemczyk, J.: Supply chain management and the circular economy: towards the circular supply chain. *Production Planning & Control* **29**(6), 425–437 (2018)
8. de Sousa, L., et al.: Circular economy business models and operations management. *J. Clean. Prod.* **235**, 1525–1539 (2019)
9. European Environment Agency: Expected growth of waste materials generated by the clean-energy infrastructure (2021). <https://www.eea.europa.eu/publications/emerging-waste-streams-opportunities-and>. Accessed 10 May 2022
10. Lee, J., Zhao, F.: GWEC | Global Wind Report 2022 (2022). [www.gwec.net](http://www.gwec.net). Accessed 9 May 2022
11. Jensen, P.D., Purnell, P., Velenturf, A.P.: Highlighting the need to embed circular economy in low carbon infrastructure decommissioning: The case of offshore wind. *Sustainable Production and Consumption* **24**, 266–280 (2020)
12. Jensen, J.P., Prendeville, S.M., Bocken, N.M., Peck, D.: Creating sustainable value through remanufacturing: Three industry cases. *J. Clean. Prod.* **218**, 304–314 (2019)
13. Velenturf, A.P.M.: A framework and baseline for the integration of a sustainable circular economy in offshore wind. *Energies* **14**(17), 5540 (2021)
14. Rentizelas, A., Trivyza, N., Oswald, S., Siegl, S.: Reverse supply network design for circular economy pathways of wind turbine blades in Europe. *Int. J. Prod. Res.* **60**(6), 1795–1814 (2022)
15. Beauson, J., Laurent, A., Rudolph, D.P., Pagh Jensen, J.: The complex end-of-life of wind turbine blades: A review of the European context. *Renew. Sustain. Energy Rev.* **155**, 111847 (2022)
16. Nagle, A.J., Mullally, G., Leahy, P.G., Dunphy, N.P.: Life cycle assessment of the use of decommissioned wind blades in second life applications. *J. Environ. Manage.* **302**(Pt A), 113994 (2022)



17. Lapko, Y., Trianni, A., Nuur, C., Masi, D.: In pursuit of closed-loop supply chains for critical materials: an exploratory study in the green energy sector. *J. Ind. Ecol.* **23**(1), 182–196 (2019)
18. Koumoulos, E.P., et al.: Research and development in carbon fibers and advanced high-performance composites supply chain in europe: a roadmap for challenges and the industrial uptake. *J. Compos. Sci.* **3**(3), 86 (2019)
19. Franco, M.A., Groesser, S.N.: A systematic literature review of the solar photovoltaic value chain for a circular economy. *Sustainability* **13**(17), 9615 (2021)
20. Tranfield, D., Denyer, D., Smart, P.: Towards a methodology for developing evidence-informed management knowledge by means of systematic review. *Br. J. Manag.* **14**, 207–222 (2003)
21. Batista, L., Bourlakis, M., Smart, P., Maull, R.: In search of a circular supply chain archetype – a content-analysis-based literature review. *Production Planning & Control* **29**(6), 438–451 (2018)
22. Martín-Martín, A., Orduna-Malea, E., Thelwall, M., López-Cózar, E.D.: Google Scholar, Web of Science, and Scopus. A systematic comparison of citations in 252 subject categories. *Journal of Informetrics* **12**(4), 1160–1177 (2018)
23. Bundesverband WindEnergie, e.V.: Rückbau und Recycling von Windenergieanlagen: Hintergrundpapier des Bundesverband WindEnergie e. V (2019)
24. Hau, E.: *Wind turbines: Fundamentals, technologies, application, economics*, Third, translated, edition, p. 879. Springer, Berlin, Heidelberg (2013)
25. Vegter, D., van Hillegersberg, J., Olthaar, M.: Supply chains in circular business models: processes and performance objectives. *Resour. Conserv. Recycl.* **162**, 105046 (2020)
26. Montag, L., Klünder, T., Steven, M.: Paving the Way for Circular Supply Chains: Conceptualization of a Circular Supply Chain Maturity Framework. *Front. Sustain.* **2** (2021)
27. Hrouga, M., Bostel, N.: Supply Chain Planning of Off-Shores Winds Farms Operations: A Review. In: Saka, A., et al. (eds.) *CPI 2019*. LNME, pp. 372–387. Springer, Cham (2021). [https://doi.org/10.1007/978-3-030-62199-5\\_33](https://doi.org/10.1007/978-3-030-62199-5_33)
28. Menzel, M.-P., Adrian, J.M.: Modularisation and spatial dynamics in the wind turbine industry: the example of firm relocations to Hamburg. *Camb. J. Reg. Econ. Soc.* **11**(2), 297–315 (2018)
29. Mert, G., Linke, B.S., Aurich, J.C.: Analysing the cumulative energy demand of product-service systems for wind turbines. *Procedia CIRP* **59**, 214–219 (2017)
30. Bonfante, M.C., Raspini, J.P., Fernandes, I.B., Fernandes, S., Campos, L.M., Alarcon, O.E.: Achieving sustainable development goals in rare earth magnets production: a review on state of the art and SWOT analysis. *Renew. Sustain. Energy Rev.* **137**, 110616 (2021)
31. Cheramin, M., Saha, A.K., Cheng, J., Paul, S.K., Jin, H.: Resilient NdFeB magnet recycling under the impacts of COVID-19 pandemic: stochastic programming and Benders decomposition. *Transportation Research Part E: Logistics and Transportation Review* **155**, 102505 (2021)

**Open Access** This chapter is licensed under the terms of the Creative Commons Attribution 4.0 International License (<http://creativecommons.org/licenses/by/4.0/>), which permits use, sharing, adaptation, distribution and reproduction in any medium or format, as long as you give appropriate credit to the original author(s) and the source, provide a link to the Creative Commons license and indicate if changes were made.

The images or other third party material in this chapter are included in the chapter's Creative Commons license, unless indicated otherwise in a credit line to the material. If material is not included in the chapter's Creative Commons license and your intended use is not permitted by statutory regulation or exceeds the permitted use, you will need to obtain permission directly from the copyright holder.





# Analysis of Elementary Technology Considering the Remanufacturing of Used Machinery: A Case Study

Yongsung Jun<sup>1</sup>(✉) and Yungchul Yoo<sup>2</sup>

<sup>1</sup> Korea National Cleaner Production Center, KITECH, Seoul, Korea  
yxjasp@kitech.re.kr

<sup>2</sup> Reliability Lab, Construction Equipment Technology Institute, Jeollabuk-Do, Iksan, Korea

**Abstract.** Globally, the circular economy is emerging as a key issue for industrial innovation by enhancing the efficiency of resource use and promoting resource circulation. Remanufacturing is to recover the product after use to maintain its original performance through a series of production processes. Machine tools experience various operational problems such as malfunction, damage to parts, and deterioration after the service life has elapsed. Remanufacturing technology has several common technologies that can solve similar failures among different items, and can be largely divided into existing remanufacturing process technology and technology for upgrading the performance of a machine. A systematic technical background is needed to ensure the performance and reliability of remanufacturing products, but so far there are few cases of research on machine tool remanufacturing in Korea.

Therefore, in this study, machinery items with high frequency of use and marketability among machine tools were reviewed as targets for remanufacturing. For the remanufacturing of used machine tools, failures to be solved by functional characteristics of target parts were identified, and remanufacturing elementary technologies were classified and analyzed, respectively. In addition, basic studies such as major performance, Failure Mode and Effect Analysis (FMEA) were conducted for the used machine tools.

**Keywords:** Remanufacturing · Machinery · Machine Tool · Failure Mode and Effect Analysis

## 1 Introduction

Globally, the circular economy is emerging as a key issue for industrial innovation by improving the efficiency of resource use and promoting resource circulation. Remanufacturing is the process of recovering a product after use at the end of its lifecycle and systematically manufacturing it to maintain its original performance through a series of production processes [1]. Therefore, remanufacturing is considered as one of the means for sustainable product production because it has a high effect of reducing energy consumption and recycling resources. Remanufacturing industry has a significant market

size in various sectors such as aerospace, heavy duty & off-road (HDOR), automotive parts, and machinery [2]. As of 2019, the global machine tool market size was 84.2 billion dollars in production, and the trade volume between countries was 46.2 billion dollars in exports and 44 billion dollars in imports [3].

The entire process of machine tools is managed by the International Organization for Standardization (ISO) TC39. The scope of machine tool standardization includes the removal of materials or the processing of metals, woods and plastics by pressure [4]. According to the KS (Korean Industrial Standards), a machine tool is defined as a machine that removes unnecessary parts by cutting or grinding a metal workpiece to create a necessary shape [5]. After the service life of 10 to 20 years has elapsed, machine tools have various operational problems such as malfunction, damage to parts, and aging. As a result, they tend to be sold after repair, sold as used goods, recycled material (scrap metal), or discarded. Machine tools are considered good remanufacturing targets as more than 80% of their materials are made up of recyclable metallic materials. It has the effect of saving energy and resources putting in the iron production process from ore, and also contributes to the reduction of carbon emission. It is necessary to develop remanufacturing technology and disseminate products for industrial machine items with high versatility, productivity and business potential among industrial machines after use. Failure is a phenomenon in which a product fails to perform a required function or does not meet its intended performance. IEC 60050–191 classifies failure, fault, and error according to the degree of failure. Failure Mode and Effect Analysis (FMEA) is a qualitative failure analysis technique that analyzes failure modes and effects of components or devices constituting a system in a bottom-up method [6]. It finds failure modes that can occur in machine tool systems and systematically analyzes their causes and effects to determine priorities. In addition, it is necessary to establish an improvement plan to remove potential failures that may occur in machine tools in use in advance, solve problems in advance, and continuously improve [7, 8].

In machine tools, the remanufacturing procedure consists of disassembly, cleaning, reverse engineering, function restoration, software reinstallation, and data upgrade for applying the latest technology after use. Although a systematic technical background is required to ensure the performance and reliability of machine tool remanufacturing products, there have been few cases of research on machine tool remanufacturing in Korea so far. Therefore, this study conducted a case study of elementary technology analysis considering remanufacturing targeting some of the used machine tools.

## 2 Research Method

In this study, I reviewed items with high frequency of use and marketability among machine tools widely distributed in industrial sites as targets for remanufacturing technology analysis. These items are 7 types of machines including lathes, injection molding machines, drawing machines, presses, milling machines, drilling machines, boring machines, and grinding machines. This study was conducted on lathes, injection molding machines, and drawing machines, and further research on the remaining items is planned in the future. The authors performed the FMEA procedure in collaboration with a research team from an OEM manufacturer of CNC lathe machines and injection

molding machines. For the remanufacturing of the used machine tool, the derivation of the failure to be solved by the functional characteristics of the target part and the classification and analysis of the remanufacturing element technology were performed respectively. In addition, basic research such as main performance, Failure Mode and Effect Analysis (FMEA), parts inspection, and part structure tree analysis was performed on the used machine tools.

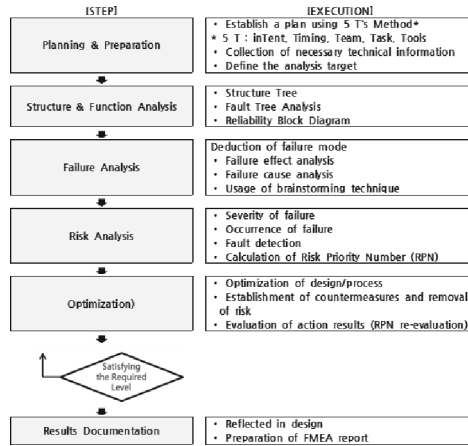


Fig. 1. Procedures for implementation of FMEA.

The procedure for performing FMEA for element parts of remanufactured machine tools is shown in Fig. 1. First, in the planning and preparation stage, the 5 T's Method (inTent, Timing, Team, Task, Tools) utilization plan is established, and analysis target definition and prior information are collected according to the purpose of FMEA. Structure Tree, Fault Tree Analysis, and Reliability Block Diagram were presented by analyzing the components and interrelationships of the items to be analyzed in the structure and function analysis stage. In the failure analysis stage, the type of failure was derived by referring to failure cases of the target machine tool and similar products in the past. In addition, a brainstorming meeting was held with experts from the research team, and related failure effects and failure causes were analyzed. In the risk analysis stage, the severity of the failure impact on parts and subsequent assemblies, systems, customers and legal restrictions was evaluated. We derived the Risk Priority Number (RPN) by considering the severity, frequency of occurrence, and degree of detection of the failure of the machine tool to be analyzed.

Figure 2 describes the failure mode and impact analysis form of remanufacturing elemental technology for elemental parts subject to remanufacturing in machine tools.

Analysis of failure mode and impact of remanufacturing element technology																	
Mmanufacturing company					FMEA Team						Control Number						
System					Product Name						Model Number						
Writer					Date Created						Revision Date						
NO.	Part/ Function ①	Failure Mode ②	failure effect ③	sever ity ④	cause of failure or mechanism ⑤	Occur rence ⑥	Remanufactur ing Design Evaluation Techniques (Management /Prevention/D etection) ⑦	Dete ctabili ty ⑧	RPN ⑨	Remanufactur ing Recommend ations ⑩	person in charge/ complete due date ⑪	Action result ⑫					
												Action Details	Sev erity	Occ urrence	Det ectabili ty	RPN	
1																	
2																	
3																	

Fig. 2. Form for analysis of failure mode and effect of remanufacturing technology.

### 3 Results

#### 3.1 Injection Molding Machine

##### (1) Overview of Injection Molding Machine

An injection molding machine is a machine that creates products of various three-dimensional shapes by injecting materials such as plastics or rubbers, melting them with heat, and then injecting high pressure into the mold. Injection molding machines are evolving in a direction to quickly respond to rapidly changing technological trends and productivity improvement demands, such as enlargement, thinning, and weight reduction of parts, and eco-friendly/substitute materials [9, 10].

The structure of the injection molding machine is largely divided into an injection unit, a clamping unit, a control system, and the like. Injection Mechanism is a device that supplies, measures, plasticizes and melts molding materials and injects them into the mold at high pressure. The clamping mechanism maintains the clamping force so that the mold does not open during resin injection, and when the resin cools and solidifies, it opens the mold and removes the molded parts. Mold, die plate, and tie bar or tie rod), clamping cylinder, ejector and other parts.

##### (2) Classification of remanufacturing element technology

The major remanufacturing element technologies of the injection molding machine were selected based on research and analysis data such as the injection molding machine's main performance, A/S data, overhaul, and parts structure tree, and remanufactured parts and performance-enhancing parts were selected. Following technologies were considered as element technologies for the remanufacturing process.

- Restoration technology using 3D additive manufacturing technology without remanufacturing worn parts for hydraulic cylinders and hydraulic pumps
- Restoration technology such as chrome plating and laser cladding for hydraulic cylinder rods, hydraulic pump pistons, and piston shoes
- State inspection of core parts, inspection instrument and jig tool optimization

- Technology that optimizes the number of revolutions according to the operating load by replacing the induction motor that supplies hydraulic power to the hydraulic injection molding machine with a servo motor
- Monitoring technology that provides information so that management and maintenance can be performed in a timely manner to extend the life of the injection molding machine by preventing failures in advance

(3) FMEA result of injection molding machine

The analysis results of failure modes and effects of remanufacturing element technology on element parts subject to remanufacturing of injection molding machines are shown in Fig. 3. The main components of the cylinder are piston seal, rod seal, cylinder tube, piston, rod, Hush & wearing, head and rod cover, cushion ring and plunger, etc. Seal parts have the functions of preventing oil leakage, preventing foreign substances from entering, and preventing rod wear. However, malfunctions such as abrasion, breakage, and hardening of seals due to long-term use of these parts result in reduced function and efficiency and shortened lifespan. In the case of cylinder tube and piston rod, due to failure causes such as abrasion, deformation, and damage, the efficiency decreases and the operation becomes impossible. Hush & wearing protects the piston seal and rod seal, but malfunctions such as damage and wear due to overload and foreign substances occur. The head and rod cover are key parts that maintain airtightness inside the tube, but they lose their function due to failures such as high load and deformation.

NO.	Part/Function ①	Failure Mode ②	Failure Effect ③	Severity ④	Cause of Failure	Occurrence ⑤	Remanufacturing Design Evaluation Technique (Management) ⑥ (Prevention/Inspection)	Detectability ⑦	RPN ⑧	Remanufacturing Recommendation ⑨	Person in charge/complete due date ⑩	Action result ⑪				
												Action Details	Severity	Occurrence	Detectability	RPN
1	piston seal/ leak prevention	leakage	reduced efficiency, stick slip	7	abnormal material, deterioration of life/ Seal wear, leakage	9	Visual inspection	5	315	exchange of new goods	KIM	exchange	7	5	2	70
		seal breakage	Decreased function, shortened lifespan	6	abnormal material, overpressure/ wear, hardening	7	Visual inspection	6	252	exchange of new goods	KIM	exchange	6	4	2	48
2	rod seal/ Prevention of ingress of abnormal material	leakage	Reduced efficiency, shortened lifespan	7	abnormal material, deterioration of life/ Seal wear, breakage	9	Visual inspection	5	315	exchange of new goods	KIM	exchange	7	5	2	70
		seal breakage	Loss of pressure, leakage	6	abnormal material, overpressure/ seal breakage	7	Visual inspection	6	252	exchange of new goods	KIM	exchange	6	4	2	48
3	cylinder tube/ Maintain rod and piston structure	damage	inoperable	8	Overload, external shock/ excess pressure	5	Visual inspection	2	80	-	-	-	8	3	2	48
		transform	external leakage, shortened lifespan	8	Overload, external shock/ generation of external force	4	cleaning, visual inspection	3	96	-	-	-	8	3	3	72
4	plunger/ pressure load transfer	Wear	reduced efficiency, inoperable	9	Overload, friction	5	Laser measurement	8	360	3D Restore	KIM	restoration	9	3	3	81
5	rod/ Power and traction transmission	coating surface scratches	reduced efficiency, no output	10	abnormal material, corrosion	6	inspection of monitoring glass	6	360	coating repair	KIM	restoration	10	4	2	80
		rod deformation	reduced efficiency	9	Overload, external load/generation	6	Laser measurement, visual inspection	3	162	3D Restore	KIM	restoration	9	4	2	72
6	DU bush & wearing/ thread protection	damage	shortened lifespan	5	abnormal material, overload/ lateral load, contact surface damage	5	cleaning, visual inspection	5	125	exchange of new goods	KIM	exchange	5	3	2	30
		Wear	external leakage	5	abnormal material, deterioration of life/ long time use	5	cleaning, visual inspection	6	150	exchange of new goods	KIM	exchange	5	3	3	45
7	head and rod cover/ Maintaining airtightness inside the tube	Assembling/ both damage	loss of pressure resistance	3	Repeat operation, vibration/ excess pressure	4	cleaning, visual inspection	2	24	-	-	-	3	2	1	6
		cover deformation	mechanical shock generation	3	Overload, external force generation/ transform	4	cleaning, visual inspection	2	24	-	-	-	3	2	1	6

Fig. 3. Analysis of failure mode and effect of remanufacturing element technology (Injection Molding Machine)

The main components of an oil cooler are heat exchangers and condensers, piping and welds, compressors, valves, oil storage tanks, oil pumps and motors, fan motors, and control panels. The heat exchanger and condenser function as fluid energy transfer and cause system failure due to refrigerant leakage, refrigerant flow stop, oil leak, oil flow stop failure. Pipes and welds must be kept airtight, and failures such as cracks and breakage occur. The compressor performs a refrigerant compression function, and the main causes of failure are bearing damage, valve failure, and seal leakage. Oil circulation is the main function of oil storage tanks and oil pumps, and errors in the oil system occur due to oil contamination, leakage, and pump failure. The fan motor acts as a heat sink and the main cause of failure are bearing damage, which causes oil temperature to rise. When the control system composed of the control panel circuit and sensor malfunctions, it causes the entire system to malfunction.

### 3.2 CNC Lathe Machine

#### (1) Overview of CNC Lathe machine

A CNC lathe is a type of machine tool that cuts a workpiece using numerical control through a computer and is used in the metal processing field. The CNC Lathe is a representative metal cutting machine that rotates the workpiece and performs cutting, sanding, drilling, turning, etc. using a tool to symmetrically process the workpiece with respect to the rotation axis. CNC lathe technology is trending towards high-speed, multi-axis, complex, precision and smart, which greatly improves cutting ability by reducing lead time and shortening machining time to increase the efficiency and productivity of the machining process, and changing the machining method while using the existing tool. In the CNC lathe, the main units are Bed unit, Spindle drive unit, X-axis assembly unit, Z-axis assembly unit, Head stock unit, Tail stock unit, Chuck, Tool post, Splash guard, Electric control unit, Hydraulic unit, Lubrication It is composed of unit, chip conveyor, and operating panel [9, 10].

#### (2) Classification of remanufacturing element technology

In the CNC lathe, the main remanufacturing element technology selected remanufactured parts and performance-improved parts based on research and analysis data such as the main performance of the CNC lathe, A/S data, overhaul, and part structure tree. The following technologies were considered as element technologies for the remanufacturing process.

- Linear axis positioning accuracy, spindle runout through the development of replacement technology for precision transfer parts (LM Guide, Ball Screw, etc.) and headstock (Shaft, chuck, spindle drive, etc.)
- Optimization of remanufacturing process to restore old products to the new level and computerized programming of work procedures
- Restoration technology that reprocesses parts using metal lamination, cladding, and metalizing technologies to reinforce large structures such as beds
- Technology that can reduce power consumption of accessories (hydraulic pumps, coolant pumps, conveyors, etc.) by more than 15% compared to existing



products by upgrading electric control devices such as controllers and applying standby power reduction technology to remanufacturing equipment

(3) FMEA result of CNC lathe machine

Figure 4 presents the results of analysis of failure modes and effects of overall remanufacturing element technology for element parts subject to remanufacturing of CNC lathe machine. The CNC lathe, FMEA for deriving element technology was performed for the remanufactured parts, the Ball screw and the spindle drive unit [11]. The main parts of Ball Screws are screw shaft, nut, return pipe, deflector, pipe press plate, wiper or seal, and steel ball etc. The return pipe and deflector function as a ball transfer function, and due to failure causes such as wear, deformation, and destruction, ball transfer is impossible. The wiper or seal prevents foreign substances from entering and leakage occurs when worn. Steel ball rotates and supports load, but failures such as fusion, deformation, destruction, and abrasion occur and cause noise, vibration, and friction increase.

NO.	Part/Function ①	Failure Mode ②	Failure Effect ③	Severity ④	Cause of Failure ⑤	Occurrence ⑥	Remanufacturing Design Evaluation Technique (Management/Prevention/Reduction) ⑦	Detectability ⑧	RPN ⑨	Remanufacturing Recommendations ⑩	Person in charge/complete due date ⑪	Action result ⑫				
												Action Details	Severity	Occurrence	Detectability	RPN
1	Screw shaft/torque transmission and load bearing	fatigue destruction	Increased friction, reduced efficiency	8	Stress Concentration/Fitting	7	Visual Inspection	2	112	material change rework	KIM	new replacement	8	4	2	64
		Wear	poor performance	9	Not aligned/overloaded	8	3D measurement	6	432	3D restoration and coating	KIM	restore	9	5	2	90
		bending	transport impossible	8	Overload/plastic deformation	4	Laser displacement measurement	3	96	-	KIM	-	-	-	-	-
2	Nut/torque transfer and load bearing	fatigue destruction	Increased friction, reduced efficiency	8	Stress Concentration/Fitting	7	Visual and non-destructive inspection	2	112	material change, rework	KIM	new replacement	8	4	2	64
		Wear	poor performance	9	Not aligned/overloaded	8	3D measurement	6	432	3D restoration and coating	KIM	restore	9	5	2	90
3	return pipe/ball transport	Transform/destroy	Ball transfer impossible	5	Not aligned/overloaded	8	3D measurement	2	20	-	KIM	-	-	-	-	-
4	deflector/ball transport	Wear	poor performance	5	overload / spalling	4	3D measurement	3	60	-	KIM	-	-	-	-	-
		Destruction	Ball transfer impossible	6	overload/destroy	2	Visual Inspection	2	24	-	KIM	-	-	-	-	-
5	Pipe Pressing Plate / Pipe Fitting	Transform/destroy	Ball transfer impossible	5	overload/destroy	4	Visual Inspection	2	40	-	KIM	-	-	-	-	-
6	Seal / prevention of abnormal material	leak/intrusion	Noise, friction, temperature rise	6	Improper lubrication/wear	5	Visual leak inspection	5	150	Seal structure and material review	KIM	new replacement	6	2	2	24
		fusion	screw shaft fatigue	9	Loss of lubrication/wear	3	Visual and operational inspection	4	108	Lubricant Review	KIM	Lubricant change	9	3	2	54
7	Ball/rotation and load bearing	transform	rotation fixed	9	Overload / brinelling	6	Inspection by magnifying glass	6	324	Load Design Review	KIM	new replacement	9	3	3	81
		Destruction	increased vibration, transport impossible	9	overload/cracking	4	Visual and operational inspection	4	72	-	KIM	-	-	-	-	-
		Wear	increased noise/vibration	10	Fatigue overload Lack of lubrication / spalling, scuffing	8	Inspection by magnifying glass	6	480	material change	KIM	new replacement	10	5	2	100
		corrosion	rotation fixed, increased noise/vibration	7	Seal fatigue, foreign matter inflow/current corrosion	6	Visual and operational inspection	3	126	Material change, coating technology review	KIM	new replacement	7	4	3	84

Fig. 4. Analysis of failure mode and effect of remanufacturing element technology (CNC lathe machine)

The spindle drive unit is a device that enables cutting by transferring the power of the CNC lathe to the belt or gear and transmitting the rotational power to the chuck that bites the workpiece. The main components of the spindle unit are Spindle, Bearing, Color, Pulley, Housing, etc. [12]. In spindle drive unit, the main shaft functions as a power transmission and support function, and the precision decreases and the lifespan are shortened due to failures such as abrasion and bending. The pulley performs a power transmission function, and the efficiency decreases due to wear and cracks. Bearings rotate and support functions, and precision is reduced due to increased friction and clearance. Housing functions as a structure and self-maintaining, and its strength decreases due to failure causes such as cracks and wear. Linear Motion Guide (LM Guide) is a part that supports and guides the load in linear motion. The main components of Linear Motion Guide are linear rail, linear block, end plate, guide bar, end seal,

seal plate, scrapper, u-bending, retainer, ball, nipple connector, etc. The linear rail acts as a guide, and poor positioning accuracy occurs due to failures such as wear and plastic deformation in linear motion guide. The end plate and guide bar function as a steel ball circulation, and friction increases in case of breakage. The end seal and seal plate function to prevent the inflow of foreign substances, and poor lubrication occurs due to wear and deterioration. The scrapper removes impurities, and plastic deformation occurs due to the inflow of foreign substances and increased friction. U-bending, retainer, ball, etc. function to support the steel ball, and abnormal operation and noise occur due to failures such as abrasion, cracks, and deformation.

## 4 Summary

In this study, we implemented the functional characteristics of major parts, failure derivation, classification of remanufacturing element technology, and Failure Mode and Effect Analysis (FMEA) for the remanufacturing of machine tools. The results derived from this study are as follows. As machine tools are made up of about 80% reusable metal materials, they are therefore considered good remanufacturing targets. It is necessary to develop remanufacturing technology and disseminate products for industrial machine items with great versatility, productivity and business potential. The main remanufacturing element technologies of the Injection Molding Machine were divided into remanufacturing process technology and spec-up technology, and among them, the results of FMEA for cylinder and oil cooler were presented. In CNC lathe machine, the results of FMEA for Ball Screws, Spindle Drive Unit, and Linear Motion Guide were presented.

**Acknowledgments.** This work was supported by Korea Institute of Energy Technology Evaluation and Planning, grant funded by the Korean government.

## References

1. Kang, H.Y., Jun, Y.S., Park, J.H., Yang, E.H.: Design of household appliances considering remanufacturing: a case study. *EcoDesign and Sustainability I*, 33–43 (2020)
2. Jun, Y.S., Kang, H.Y., Jo, H.J., Baek, C.Y., Kim, Y.C.: Evaluation of environmental impact and benefits for remanufactured construction equipment parts using life cycle assessment. *Procedia Manufacturing* **33**, 288–295 (2019)
3. Korea Machine Tool Manufacturers' Association: 2020 Machine tool industry statistics yearbook (2020)
4. ISO/TC 39 Machine tools. <https://www.iso.org/committee/48354.html>
5. Korean Standards Service Network: Glossary of terms relating to parts of machine tools and operation (2012)
6. AIAG&VDA: FMEA Handbook. Automotive Industry Action Group, Michigan (2019)
7. IEC 60812:2018 Failure modes and effects analysis (FMEA and FMECA)
8. SAE J1739: Potential Failure Mode and Effects Analysis (FMEA) Including Design FMEA, Supplemental FMEA-MSR, and Process FMEA (2021)
9. Hoffman, P., Hopewell, E.: Precision Machining Technology. NIMS (2020)

10. Boothroyd, G., Knight, W.A.: Fundamentals of Machining and Machine Tools, 3rd edn. Taylor & Francis (2006)
11. Ball screw for positioning: RSB0071/RS-KIMM-2010-0036 (2010)
12. Belt driven spindle unit for CNC lathes: RS-KIMM-2011-0110 (2011)

**Open Access** This chapter is licensed under the terms of the Creative Commons Attribution 4.0 International License (<http://creativecommons.org/licenses/by/4.0/>), which permits use, sharing, adaptation, distribution and reproduction in any medium or format, as long as you give appropriate credit to the original author(s) and the source, provide a link to the Creative Commons license and indicate if changes were made.

The images or other third party material in this chapter are included in the chapter's Creative Commons license, unless indicated otherwise in a credit line to the material. If material is not included in the chapter's Creative Commons license and your intended use is not permitted by statutory regulation or exceeds the permitted use, you will need to obtain permission directly from the copyright holder.





# Measurement of Disassembly Work Using Optical Motion Capture

Ryuto Kawane<sup>1</sup>, Hiromasa Ijuin<sup>1</sup>, Ryosuke Nakajima<sup>1</sup>, Masao Sugi<sup>2</sup>,  
Shuho Yamada<sup>3</sup>, and Tetsuo Yamada<sup>1</sup>✉

<sup>1</sup> Department of Informatics, The University of Electro-Communications, 1-5-1 Chohugaoka,  
Tokyo 182-8585, Japan

{k2230047, i2040014}@edu.uec.ac.jp, {nakajima,  
tyamada}@uec.ac.jp

<sup>2</sup> Department of Mechanical and Intelligent Systems Engineering, The University of  
Electro-Communications, 1-5-1 Chohugaoka, Tokyo 182-8585, Japan

sugi@mce.uec.ac.jp

<sup>3</sup> Department of Mechanical Systems Engineering, Faculty of Engineering, Toyama Prefectural  
University, 5180 Kurokawa, Imizu, Toyama 930-8555, Japan

syamada@pu-toyama.ac.jp

**Abstract.** In recent years, the depletion of natural resources has been severe globally. One of the solutions to this problem is to reuse and recycle materials from end-of-life (EOL) products and reduce waste. In the industrial field, disassembly work is needed to take back parts/materials from the end-of-life assembly products. Furthermore, in the manufacturing industry, there are human resource development or skill transfer issues due to a declining birth rate and an aging population as well as a labor shortage in developed countries. In particular, in Japan, the population aged 65 and over reached 28.8% of the total population in 2019, and the labor shortage has become more serious. To resolve these issues, the digitization of skills through optical motion capture is promoted in this industry, where three-dimensional coordinate data of workers can be accurately measured. Toshiba Corporation has introduced motion capture for achieving more effective guidance and skill transfer at the work site. However, data related to disassembly were not obtained via motion capture. This study measures and analyzes the motion data for disassembly work obtained via optical motion capture. First, the motion data for disassembly work is obtained via optical motion capture. Next, the data obtained is shown graphically and compared by body part. Finally, the results are shown and discussed.

**Keywords:** Reuse and Recycling · Work Analysis · Motion Tracking · Digital Transformation · Sustainable Manufacturing

## 1 Introduction

In recent years, the depletion of natural resources has been severe globally. One of the solutions to this problem is to reuse and recycle materials from End-of-Life (EOL) products and reduce waste [1]. In the industrial field, disassembly work is needed to take

back parts/materials from EOL assembly products. Furthermore, in the manufacturing industry, the labor shortage due to the falling birthrate and aging population has made it difficult to train human resources and achieve skill transfer [2]. In order to solve such problems, the manufacturing industry has been promoting digitization using sensors and Artificial Intelligence (AI) analysis [3, 4]. Digitization has a profound impact on daily life, changing people's lives for the better in all aspects. Such a digitization method is called "Digital Transformation (DX)" [5]. In addition, motion capture has been introduced at the work site for more effective instruction and skill transfer [6]. Motion-capture [7] technology can accurately measure human body movements, and can acquire time and three-dimensional time-series coordinate data simultaneously.

In previous studies, human positioning measurements have been performed at work sites using acceleration and magnetometer sensors [8]. Liu et al. [9] conducted research using video motion capture to realize a manufacturing system in which robots and human coexist. However, optical motion capture, which could accurately measure position coordinates was not used. On the other hand, Kawane et al. [10] measured and analyzed the assembly work using optical motion capture and machine learning, although they did not treat the disassembly works. Moreover, Wilhelm et al. [11] proposed an ergonomic approach to optimize an entire manual assembly process chain in a manual assembly line using ErgoSentinel Software and a Microsoft Kinect depth camera. However, the measurement of disassembly works and that with optical motion capture, which can obtain high-precision absolute position coordinates, are not conducted.

This study measures and analyzes the motion data for disassembly work obtained via optical motion capture, and the following Research Questions (RQs) are developed.

RQ1: How do the worker's movements change with each disassembly work?

RQ2: How does the worker proficiency affect the disassembly work?

## 2 Method

This study designs an experiment, where the disassembly process involves loosening nuts. The nut-loosening work is conducted with the instruments on the desk with standing, and loosens the nut with their dominant hand while holding the instrument with the opposite hand. The nuts are of the M16 type [12], i.e., non-loosening nuts.

The measurement is performed using an MAC3D Kestrel-300 optical motion capture system from NAC Image Technology, Inc. [13] at a frame rate of 60 fps. The accuracy of the MAC3D system is less than 1mm average error [13], and the least significance of the raw data is 10 nm displayed in the device. The amount of data for 3D coordinates obtained via optical motion capture is large, and an operation for approximately 15 s consists of approximately 36,000 data (approximately 1,000 frames  $\times$  3 dimensions  $\times$  12 markers) as in the case of this study. The data measurement procedure is as follows.

1. The worker wears clothing with 10 reflective markers (Fig. 1).
2. A wrench (Fig. 1) with reflective markers on the upper jaw and grip is used.
3. The nut is loosened for two turns by using the wrench according to a line marked in advance.

4. The third work of 10 times and a 5-min break is conducted three times.

Figure 1 shows the positions of the reflective markers attached to the operator and the wrench based on Helen Hayes Marker Set [14]. For the worker, Three-Dimensional (3D) position coordinates are obtained for the top of the head, back of the head, front of the head, right shoulder, right elbow, right wrist, left shoulder, left elbow, left wrist, and back. For the wrench, the 3D position coordinates of the upper jaw and grip are acquired.

To analyze the motion changes and the worker proficiency in the disassembly work by obtaining time-series coordinate data via motion capture, the average, standard deviation and the movements of each disassembly work are compared.

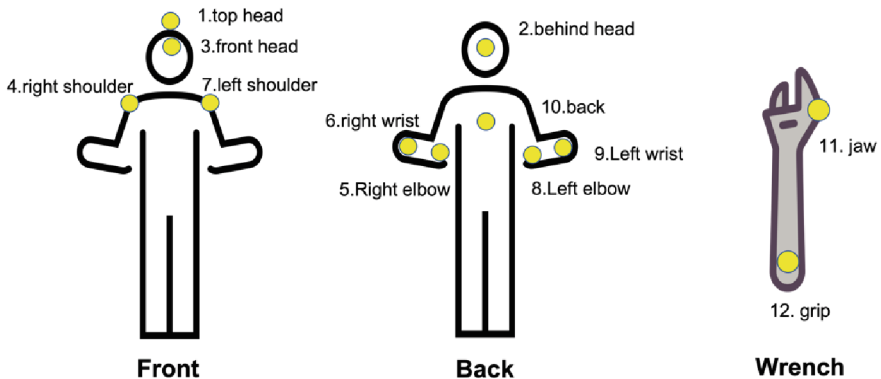


Fig. 1. Attachment points of reflective markers for using motion capture.

### 3 Results

For considering a difference by the worker's proficiency, the working time and the values obtained via motion capture in each working session are compared in this section.

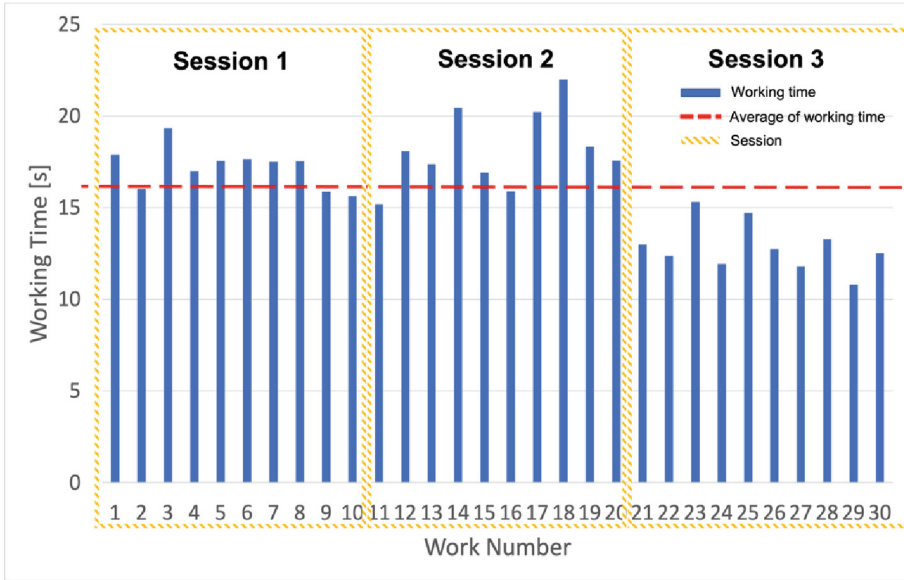
#### 3.1 Result of Disassembly Time

Figure 2 shows the observed working time of disassembly work from the 1st to the 30th operation for loosening the nut. The horizontal axis indicates the work number, and the vertical axis shows the working time at each work. The yellow lines correspond to intervals of respective 10 operations, and the red line indicates the mean working time. It is found that all the working times from the 21st to the 30th works were shorter than the average working time.

Table 1 presents the mean and standard deviation of working time for each of the 10 work sessions. The average working time for session 3, consisting of the 21st to the 30th operation, was reduced by 25.3% and 29.4% compared with one in the other two sessions, respectively. Thus, this result implies learning effect, where the workers

became accustomed to the operation through repetition. The standard deviations for the session 2 and session 3 are greater than ones for session 1. It is considered that worker fatigue and the search for tricks to perform the work efficiently have caused the variation in the working time. In addition, the learning effect observed and expected level since the value of session 3 became smaller than that of session 2.

From now, to identify the differences in the movements that affected the reduction in the working time, the transitions of the 3D coordinates for each marker in the first two operations and the last two ones are observed and compared.



**Fig. 2.** Observed working time of disassembly work in each session.

**Table 1.** Average and standard deviation of working time in each session and total

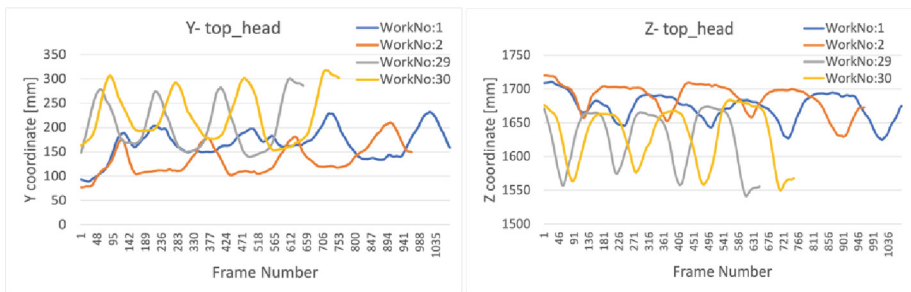
	Session 1 (1st–10th)	Session 2 (11th–20th)	Session 3 (21st–30th)	All (1st–30th)
Average [s]	17.198	18.203	12.845	16.082
Standard deviation [s]	1.0559	2.0176	1.279	2.771

### 3.2 Results of Movements Measured

In the previous section, it is found that there is a possibility that the worker’s physical movements are also different because the average working time was different in each session. In this section, the worker’s movements are analyzed by using optical motion

capture. Specifically, to investigate the relationship between the working time and the worker's movements, the movements of the first two operations at the 1st and 2nd and the last two operations at the 29th and 30th are compared.

Figure 3 presents the position coordinates of the reflective marker affixed to the top of the worker's head. The horizontal axis means Y or Z coordinate value, and the vertical axis shows the number of frames at each work. As shown in Fig. 3 (1), there is a large difference in the Y-coordinate between the first two operations and the last two ones. For instance, the variation of the Y-coordinate for the last two operations was approximately by 65.3 [mm] larger on average than that for the first two operations. This indicates that the head was moved in front of the body with moving their head to forward at the same time when the worker loosened the nut in the last two operations. For the Z-coordinate, the first two movements exhibited only small fluctuations of 88.2 [mm] on average, whereas the last two movements indicated large fluctuations of 133.4 [mm] on average. This means that the worker moved his head forward, and that his center of gravity was in front of his body when he lowered his head while loosening the nut. One of the reasons is that these movements make it easier to apply force to the arms.



(1) Y-coordinate

(2) Z-coordinate

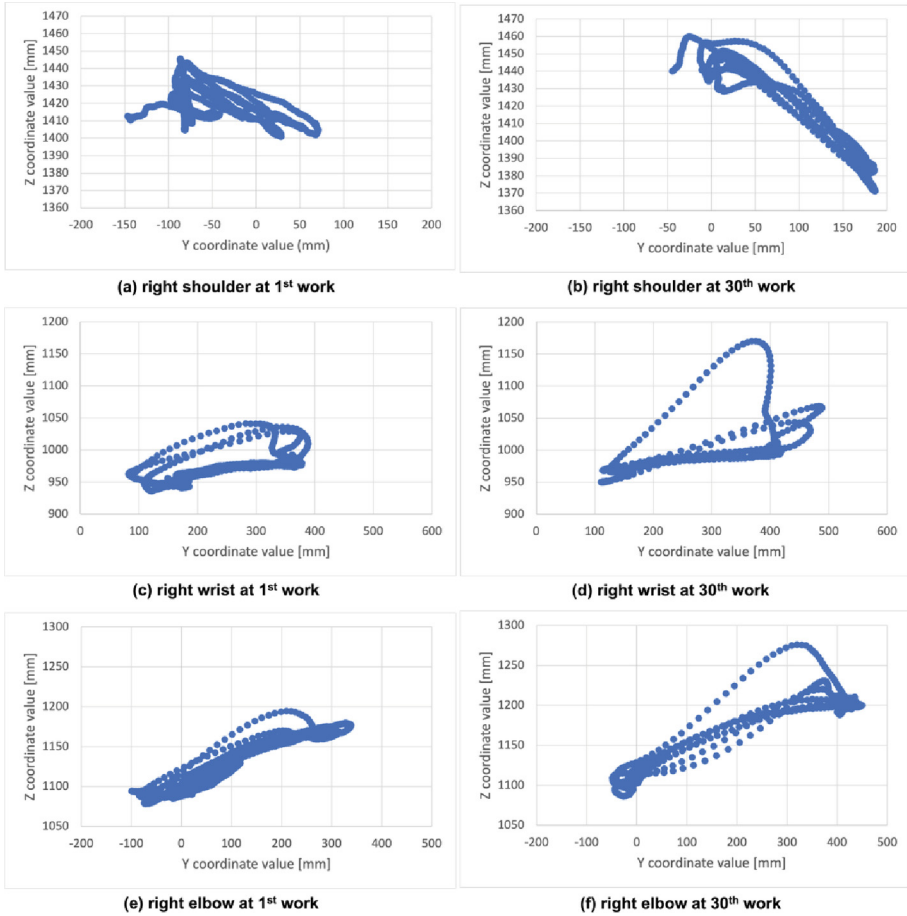
**Fig. 3.** Time-series data values of top of the head: (1) Y-coordinate and (2) Z-coordinate

Figure 4 shows the movements of the right shoulder, right elbow, and right wrist in the Y-Z (depth-height) plane. The horizontal axis indicates Y coordinate value, and the vertical axis shows Z coordinate value at each work. The range of motion was relatively wider for the 30th work at all three locations. The 30th movement was by 29.8 [mm] greater downward and by 116.2 [mm] greater forward for the shoulder movement. This is because more weight could be applied to the front. In contrast, the elbows and wrists moved more upward by 105.0 [mm] on average. This means that the worker turned the nut using not only the force to push it forward but also another force to move it upward. Thus, in this nut-loosening operation, putting the body weight forward and using the force to raise the elbow and wrist improved the efficiency.

### 3.3 Discussion

Based on the results in Sects. 3.1 and 3.2, the RQs developed in Sect. 1 are answered as follows:





**Fig. 4.** The time series data of the right shoulder, right elbow, and right wrist in the Y-Z (depth-height) plane.

- Answer of RQ1: How does the worker's movements change with each disassembly work?

It was found that the worker moved his head and right arm more forward by approximately 65.3 [mm] and 105.5 [mm] on average at the 30th work compared with the 1st work. Therefore, it is considered that the worker became accustomed to the operation through repetition.

- Answer of RQ2: How does the worker's proficiency affect the disassembly work?

The upper half of the body was moved more forward, the head and shoulder were moved more downward, and the wrist and elbow were moved more upward. These movements are considered to make the nut loosening process more efficient. In addition,

the worker's proficiency through repetition of the same work was found to reduce the working time by approximately 27% in the nut-loosening work.

The results indicate that variation in working motion and time in experimented disassembly works, can be measured and identified by using optical motion capture. Since the identified disassembly motion and time enable us to improve the work, the proposed measurement of disassembly work using optical motion capture can contribute efficient reuse/recycling and automation of disassembly works for sustainability.

The limitation of this study is that it is impractical to draw and analyze the transitions of position coordinates graphically since the data obtained via optical motion capture is huge. Thus, it is expected that machine learning, which is useful for processing large amounts of data, will be used to analyze the data. The usage of machine learning to analyze high-precision position-coordinate data obtained from optical motion capture is expected to support the transfer of operator skills from an unprecedented perspective.

## 4 Summary and Future Studies

This study measured and analyzed the motion data for disassembly work obtained via optical motion capture. As an example of disassembly work, the work of loosening a nut was measured and analyzed. Among a total of 30 works, the working time was relatively short for the last 10 works. Therefore, to investigate the relationship between the working time and the worker's movements, the movements in the 3-D position coordinates obtained via motion capture for the first two works and the last two works were compared.

Future works should verify the findings from these results in every case, and consider the analysis of the motion data obtained via optical motion capture by machine learning to quantitatively extract tacit knowledge in the work [10].

**Acknowledgement.** We would like to express my gratitude to Mr. Masahiro Nagano at Prof. Masao Sugi Laboratory in the University of Electro-Communications for his cooperation in acquiring the data. This study was partially supported by the Japan Society for the Promotion of Science (JSPS), KAKENHI, Grant-in-Aid for Scientific Research (A), JP18H03824, from 2018 to 2023.

## References

1. Gupta, S.M., Lambert, A.J.D. (eds.): CRC Press, Boca Raton (2008)
2. Ministry of Economy, Trade and Industry, Ministry of Health, Labour and Welfare, Ministry of Education, Culture, Sports, Science and Technology: White Paper on Monodzukuri 2021 (FY2020 White Paper on Manufacturing Industries), Japan (2021) (in Japanese)
3. Ertel, W.: Introduction to Artificial Intelligence. Springer, Heidelberg (2017)
4. Information-Technology Promotion Agency, Japan: White Paper on Artificial Intelligence 2020. Kadokawa, Japan (2020) (in Japanese)
5. Raphael, P., Konstantinos, N., Konstantia, L.: Transformation strategies for the supply chain: the impact of industry 4.0 and digital transformation. *Supply Chain Forum Int. J.* **21**(1), 26–34 (2020)

6. TOSHIBA, Toshiba Clip, Exploring the Secrets of Engineering and Maestro through Motion Capture. <https://www.toshiba-clip.com/en/detail/p=342>. Accessed 12.05.22 (in Japanese)
7. Nakazawa, A.: Keywords you should know motion capture. *J. Inst. Image Inf. Televis. Eng.* **63**(9), 1224–1227 (2009). (in Japanese)
8. National Institute of Advanced Industrial Science and Technology: Collaboration between Ganko Food and AIST, AIST Link No. 12, pp. 6–11, Japan (2017) (in Japanese)
9. Liu, Z., Liu, Q., Xu, W., Liu, Z., Zhou, Z., Chen, J.: Deep learning-based human motion prediction considering context awareness for human-robot collaboration in manufacturing. *Procedia CIRP* **83**, 272–278 (2019)
10. Kawane, R., et al.: Work analysis of movements and estimation of workers using motion capture and machine learning. *J. Soc. Plant Eng. Jpn.* **34**(3), 34–44 (2022) (in Japanese)
11. Wilhelm, M., et al.: ErgoTakt: a novel approach of human-centered balancing of manual assembly lines. *Procedia CIRP* **97**, 354–360 (2021)
12. Monotaro M16. <https://www.monotaro.com/p/4210/1997/>. Accessed 12.05.20 (in Japanese)
13. NAC Image technology Inc., MAC3D System. <https://www.nacinc.jp/analysis/motion-capture/mac3d-system/> Accessed 12.05.22 (in Japanese)
14. Kadaba, M.P., Ramakrishnan, H.K., Wootten, M.E.: Measurement of lower extremity kinematics during level walking. *J. Orthop. Res.* **8**(3), 383–392 (1990)

**Open Access** This chapter is licensed under the terms of the Creative Commons Attribution 4.0 International License (<http://creativecommons.org/licenses/by/4.0/>), which permits use, sharing, adaptation, distribution and reproduction in any medium or format, as long as you give appropriate credit to the original author(s) and the source, provide a link to the Creative Commons license and indicate if changes were made.

The images or other third party material in this chapter are included in the chapter's Creative Commons license, unless indicated otherwise in a credit line to the material. If material is not included in the chapter's Creative Commons license and your intended use is not permitted by statutory regulation or exceeds the permitted use, you will need to obtain permission directly from the copyright holder.





# Simulation-Based Analysis of (Reverse) Supply Chains in Circular Product-Service-Systems

Julian Grosse Erdmann<sup>1</sup> (✉), Jan Koller<sup>1</sup>, Saman Amir<sup>2</sup>, Aleš Mihelič<sup>3</sup>,  
and Frank Döpfer<sup>1,4</sup>

<sup>1</sup> Fraunhofer Institute for Manufacturing Engineering and Automation IPA, Universitaetsstrasse  
9, 95447 Bayreuth, Germany

`Julian.Grosse.Erdmann@ipa.fraunhofer.de`

<sup>2</sup> Department of Marketing and Strategy and Centre for Sustainability Research, SSE  
Stockholm School of Economics, Hölländargatan 32, 11383 Stockholm, Sweden

<sup>3</sup> Gorenje Gospodinjski Aparati d.d, Partizanska Cesta 12, 3320 Velenje, Slovenia

<sup>4</sup> Chair Manufacturing and Remanufacturing Technology, University of Bayreuth, Bayreuth,  
Germany

**Abstract.** With an expected growth of global waste to 3.40 billion tonnes by 2050 and a circularity today of only 8.6% of the world, the earth's sustainable resources are being exploited beyond their regeneration capacity. Hence, it is necessary to step away from a take – make – dispose principal and transform from a linear towards a circular economy to close product cycles to optimize resource consumption and reduce waste. Product-Service-Systems (PSSs), based on multiple product life cycles combined with remanufacturing, offer a solution to close product cycles. In such PSS, the responsibility for returning, remanufacturing, and repairing used products remains with the Original Equipment Manufacturer (OEM) and increases its need in (reverse) supply chain activities. Essential factors for (reverse) supply chains are, e.g., determining the distribution network, the location of recovery facilities, the geographical dispersion of the customers, and the information flows between the different stakeholders. In this context, this work proposes a multi-method simulation model to support practitioners in determining the optimal infrastructure for storing, remanufacturing, and repairing the used products regarding economic and ecological target criteria. The applicability of the proposed approach is illustrated through a case study of a white goods manufacturing company. This case study highlights the importance of determining the optimal infrastructure in a (reverse) supply chain in PSS business models.

**Keywords:** Circular Economy · Product-Service-Systems · Simulation · Facility Location Problem

## 1 Introduction

The consequences of the linear economy, such as anthropogenic climate change, increasing amounts of waste, and growing scarcity of raw materials, transform a circular economy indispensable. Among the multitude of end-of-life strategies, remanufacturing is one of the key elements of a circular economy.

© The Author(s) 2023

H. Kohl et al. (Eds.): GCSM 2022, LNME, pp. 111–118, 2023.

[https://doi.org/10.1007/978-3-031-28839-5\\_13](https://doi.org/10.1007/978-3-031-28839-5_13)

An essential prerequisite for successful remanufacturing is the user's return of the used products. Although several incentive systems exist to encourage the user to return the product, these are usually associated with a high degree of uncertainty regarding the timing and quantity of the returns and the quality of the used products [1].

Product-service systems (PSS), which can be defined as a "marketable set of products and services capable of jointly fulfilling a user's need", are a promising approach to solving this problem [2]. In particular, the user-oriented services form of PSS, where the Original Equipment Manufacturer (OEM) remains the product's owner, allows for better planning of the remanufacturing processes. Furthermore, these new business models enable OEMs to create new sources of added value and competitiveness while at the same time fostering sustainability [3]. To this end, it is necessary to plan and design the (reverse) supply chain and define the locations and capacities for the collection, return, and remanufacturing of the used products, in addition to the production and distribution of the products.

## 2 Related Work

Over the past decades, several methods and approaches have been developed addressing (reverse) supply chain network design and facility location problems in circular economy business models [4, 5]. Dominguez et al. [4] explored the impact of the critical decision on (reverse) supply chain performance by comparing centralized and decentralized remanufacturing scenarios. The developed simulation considers different return rates, information transparency levels, and nodes in the reverse supply chain. Lieckens et al. [6] developed a strategic decision support tool for (reverse) supply chain networks by considering the number of locations, capacities, and inventory levels of remanufacturing facilities.

Several articles tackled the problem of solving the facility location problem in (reverse) supply chains by developing mixed-integer programming models [7–9]. For example, Aljuneidi and Bulgak [7] developed a model for reverse supply chain networks to minimize carbon emissions and transportation distances.

Despite the importance of identifying the optimal (reverse) supply chain network design, few published works considered the impact of PSS in a circular economy. Bal and Badurdeen [10] presented a multi-objective optimization model considering PSS' social, environmental, and economic criteria. The study aims to optimize the locations of end-of-life product recovery facilities. An additional paper by Bal and Badurdeen [11] presents a simulation-based optimization approach for (reverse) supply chain network design, comparing a 'selling' with a 'lease and sell' strategy.

However, existing approaches lack incorporating customer behavior and the stochastic characteristic of product end-of-life regarding the quantity, timing, and quality of the returned products for PSSs' (reverse) supply chain network design. Hence, this study aims to develop a decision support tool based on multi-method simulation for PSS (reverse) supply chain network design by identifying the optimal locations for recovery operations such as repair and remanufacturing. Based on customer base, repair, and remanufacturing volumes, the simulation model can respond flexibly to environmental changes and help to decide which existing physical infrastructure should be integrated

into the (reverse) supply chain. In this context, the simulation model incorporates the stages of manufacturing, use phase, and remanufacturing of a product's multiple life cycles.

### 3 Methodology

Many different procedure models for conducting simulation studies can be found in the literature. Nevertheless, almost all procedure models consist of task and system analysis, model formulation, model implementation, model verification, and model application, although the names can vary widely [12].

First, starting from a real or planned system, the task and system analysis are carried out to define the simulation's objective and describe the system's elements under consideration, e.g., concerning the level of detail, as a basis for the simulation model [13]. This is followed by the model formulation, in which the creation of a simulation model by abstracting irrelevant characteristics and mapping relevant characteristics takes place [14]. For this purpose, a descriptive concept model is first created, which contains the basic system functions and interactions [15]. The formal or structural model concretizes the conceptual model and is structurally described, e. g., by program flow charts, state transition diagrams, or block diagrams [15, 16]. Next, the model implementation takes place, i.e., creating an executable program, the simulation model, using suitable programming languages [16]. The model verification is used to check if the simulation model contains logical errors ('semantic correctness') and if the simulation software or other modeling tools were used according to the specified syntactic rules ('syntactic correctness') [17]. This verification and validation is a permanent, iterative process that accompanies all phases of a simulation study [15, 16]. With the model application in the form of simulation experiments, information can then be obtained to explain the behavior of the real system and the future behavior of the modified real system. The results of the simulation experiments are initially formal results that can be used either to adapt the simulation model ('gaining knowledge') or to implement it in the real or planned system ('using knowledge') [18–20]. The simulation results serve as decision support and must be evaluated and processed in a suitable form to enable interpretation [16]. Based on the conclusions for the real system, the cycle is closed, e.g., to adapt the model to new conditions of the real system [21].

### 4 Case Study

The proposed methodology was applied to a case study with a white goods manufacturing company involved in the EU project 'Resource-efficient Circular Product-Service-Systems' (ReCiPSS). The whitegoods company is piloting a PSS offering for 300 washing machines in four markets, i.e., the Netherlands. The washing machine model relevant for the study is a high-end product for heavy-duty applications designed for 30,000 washing cycles. This model is usually in service for seven years on average before users replace the machines for different reasons [22].

To scale up the implementation of PSS, it is planned that during the product lifetime of the washing machine, each washing machine will be remanufactured twice and

serve over three life cycles of five years. To support a new business model for washing machines based on multiple life cycles and product remanufacturing, the white goods manufacturing company will require a new (reverse) supply chain infrastructure.

#### 4.1 Task and System Analysis

The multi-method simulation model evaluates the economic and ecological performance of the (reverse) supply chain infrastructure. To determine the optimal infrastructure, the simulation model considers several objective functions to minimize the transport and storage costs, service time, and CO<sub>2</sub> emissions of the PSS washing machines during their complete product lifecycle.

The model boundary consists of the geographical location of the value chain stakeholders, namely manufacturer, warehouse, customers, retailers, and remanufacturers, involved in the white goods demonstrator of the ReCiPSS project.

All relevant data for simulation was gathered continuously from 2018 to 2020 in workshops and open-ended interviews with the white goods manufacturing company and their service providers involved. The supply chain-related data, such as the location of facilities (warehouse, retailers), transport costs, and reverse logistics, were collected. In addition, data and assumptions were adopted from Roci et al. [23] to develop the simulation model.

#### 4.2 Model Formulation

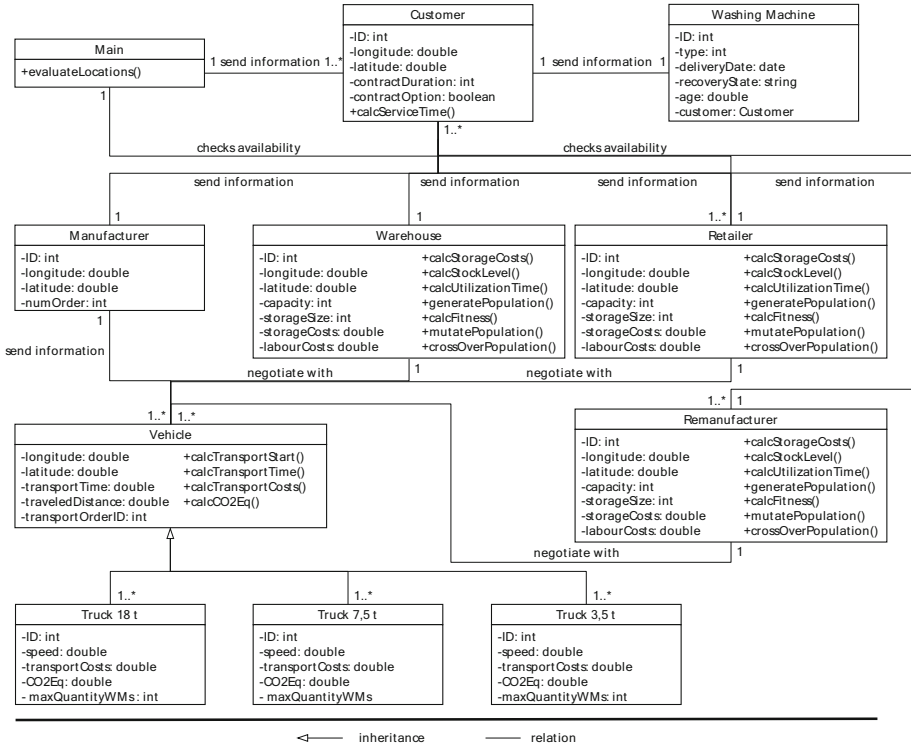
A class diagram with its classes, attributes, and relationships was described based on the system analysis, see Fig. 1.

At the core of this class diagram, the Main agent selects individual locations of the manufacturer, warehouse, customers, retailers, and remanufacturers for the (reverse) supply chain. The locations are selected to ensure a high target fulfillment according to the target criteria mentioned in Sect. 4.1. Therefore, the Main agent uses an ADD algorithm to search the solution space to generate an optimal or near-optimal solution (+evaluateLocations()).

For the calculation, the Main agent needs information about customers, capacity utilization and costs of the locations' warehouse, and vehicles depending on washing machine orders, repair, and remanufacturing requests. Therefore, each location can calculate their stock level (+calcStockLevel()), and utilization time of the vehicles (+calcUtilizationTime()). The locations receive information about washing machine orders, repair, and remanufacturing requests and allocate them to the vehicles. For the order allocation, a genetic algorithm is applied (+generatePopulation(), +calcFitness(), +mutatePopulation(), +crossoverPopulation(), +selectPopulation()).

For the order allocation, the locations need information about the transportation times, transportation start, and utilization times of the vehicles. Each vehicle is thus able to calculate their transportation start (+calcTransportStart()) and time (+calcTransportTime()) according to their position, speed, and availability. Then, the locations 'negotiate' with the vehicles, which can modify the solution based on local knowledge (+mutatePopulation()). Finally, the best-found solution will be taken to allocate the order to the vehicles.

Furthermore, the customers are represented by the Customer agent. The characteristic of the customer differs in the choice of the service package, e.g., contract duration, service level, and behaviors in terms of premature contract termination and subscription renewal.



**Fig. 1.** Class diagram of the (reverse) supply chain of the white goods demonstrator model

### 4.3 Model Implementation and Verification

A multi-method approach comprising the Agent-based and Discrete Event techniques to model the (reverse) supply chain was chosen. Therefore, the AnyLogic Professional 8.7.2 software was selected to develop the simulation model [24].

The simulation model consists of the Agents Main, Manufacturer, Remanufacturer, Warehouse, Retailer, Vehicle, Customer, and Washing Machine. The agents are placed in a geospatial environment defined by the GIS map according to the supply chain configuration of the white goods company. The simulation duration of individual runs was determined statically by a time-related event. The duration of the simulation time was set to fifteen years.

Finally, verification techniques presented in Rabe et al. [12] were implemented during the simulation study. To ensure that the simulation model meets the theoretical requirements, animation using 2D and 3D graphics, trace analysis, extreme-condition test, and face validity with the case company was applied.



#### 4.4 Model Application

Within the model application, the system behavior in the demonstrator phase of the PSS business model for white goods in the Dutch market is analyzed based on the simulation results. For this purpose, the total transport and storage costs, service time, and CO<sub>2</sub> emissions of the PSS washing machines in the three scenarios were determined and compared. In scenario one, the customers were distributed in Amsterdam, in scenario two, in Groningen, and in the last scenario, the customers were randomly distributed throughout the country.

Concerning the target figure ‘transport and storage costs’, scenario one with customers in Amsterdam is less expensive than scenario two, with customers in Groningen by ca. 45%. Compared to scenario three, where customers are spread across the whole country, ca. 27% more costs are incurred than in scenario one.

Considering the target figure ‘service time’, the customer requests, e.g., a request for a technician in case of machine failure, can be fulfilled in scenarios one and two within 15 h on average. In scenario three, customers typically have to wait 21 h until their requests are fulfilled. On average, the white goods company’s minimum requirement of fulfilling the customer’s request within 24 h is reached in all three scenarios.

Regarding the target figure ‘CO<sub>2</sub>-emissions’, ca. 76% of CO<sub>2</sub> emissions incurred less in scenario one than in scenario two. Compared to scenario three, 57% more CO<sub>2</sub> emissions were incurred than in scenario one.

### 5 Conclusion and Outlook

Due to different usage patterns and environmental influences, the characteristics of remanufacturing of used products reflect a high uncertainty regarding the product state, the stochastic return time, and the amount of returned products. This complexity ultimately leads to fluctuating capacity utilization and throughput times and high opportunity costs and thus also directly represents a risk to the company’s success.

Therefore, this study proposes a decision support tool based on a multi-method simulation model for PSSs’ (reverse) supply chain network design by identifying the optimal locations for recovery operations such as repair and remanufacturing. Based on the results obtained from the simulation model, the importance of determining the optimal locations for circular PSS business models is highlighted. In the considered scenarios for the Dutch market, scenario one with customers in Amsterdam performed most favorably.

The findings of this study can serve as a basis for further research activities. In this paper, assumptions concerning customer behavior, e.g., subscription duration, usage of the washing machine, or buying behavior, were made due to a lack of publicly available market data. Furthermore, certain input parameters of the model proposed, such as inventory costs, transport costs, or labor costs, are constant over the entire lifecycle. A logical extension would be to relax the deterministic assumption of input data and develop stochastic optimization models. In general, it is to be noted that this study does not consider the success of the business model and the social impact.

Also, a more efficient intelligent algorithm can be designed and compared with the presented algorithm to improve the optimization problem’s solution space.

In addition, further target figures for the future scenario could be introduced, such as qualification and education, wage and salary, and environmental protection.

**Acknowledgment.** This work has been conducted as part of the ReCiPSS project that has received funding from the European Union's Horizon 2020 research and innovation program under grant agreement No. 776577.

## References

1. Asif, F.M.A., Bianchi, C., Rashid, A., Nicolescu, C.M.: Performance analysis of the closed loop supply chain. *J. Remanufact.* **2**(1) (2012)
2. Goedkoop, M.J., van Halen, C.J., te Riele, H.R., Rommens, P.J.: *Product Service Systems, Ecological and Economic Basics: Ecological and Economic Basics* (1999)
3. Tukker, A.: Product services for a resource-efficient and circular economy – a review. *J. Clean. Prod.* **97**, 76–91 (2015)
4. Dominguez, R., Cannella, S., Framinan, J.M.: Remanufacturing configuration in complex supply chains. *Omega* **101**, 102268 (2021)
5. Deveci, M., Simic, V., Torkayesh, A.E.: Remanufacturing facility location for automotive Lithium-ion batteries: an integrated neutrosophic decision-making model. *J. Clean. Prod.* **317**, 128438 (2021)
6. Lieckens, K.T., Colen, P.J., Lambrecht, M.R.: Optimization of a stochastic remanufacturing network with an exchange option. *Decis. Support Syst.* **54**(4), 1548–1557 (2013)
7. Aljuneidi, T., Bulgak, A.A.: Carbon footprint for designing reverse logistics network with hybrid manufacturing-remanufacturing systems. *J. Remanuf.* **10**(2), 107–126 (2019). <https://doi.org/10.1007/s13243-019-00076-5>
8. Yan, R., Yan, B.: Location model for a remanufacturing reverse logistics network based on adaptive genetic algorithm. *Simulation* **95**(11), 1069–1084 (2019)
9. Kilic, H.S., Cebeci, U., Ayhan, M.B.: Reverse logistics system design for the waste of electrical and electronic equipment (WEEE) in Turkey. *Resour. Conserv. Recycl.* **95**, 120–132 (2015)
10. Bal, A., Badurdeen, F.: A multi-objective facility location model to implement circular economy. *Procedia Manuf.* **51**, 1592–1599 (2020)
11. Bal, A., Badurdeen, F.: A simulation-based optimization approach for network design: the circular economy perspective. *Sustainable Prod. Consump.* **30**, 761–775 (2022)
12. Rabe, M., Spiekermann, S., Wenzel, S.: *Verifikation und Validierung für die Simulation in Produktion und Logistik: Vorgehensmodelle und Techniken*. Springer, Berlin, Heidelberg (2008)
13. Gutenschwager, K., Rabe, M., Spiekermann, S., Wenzel, S.: *Simulation in Produktion und Logistik*. Springer, Berlin, Heidelberg (2017)
14. Eley, M.: *Simulation in der Logistik: Einführung in die Erstellung ereignisdiskreter Modelle unter Verwendung des Werkzeuges "Plant Simulation."* Springer Berlin Heidelberg, Berlin, Heidelberg (2012)
15. Wenzel, S., Collisi-Böhmer, S., Pitsch, H., Rose, O., Weiß, M.: *Qualitätskriterien für die Simulation in Produktion und Logistik: Planung und Durchführung von Simulationsstudien*. Springer-Verlag, Berlin Heidelberg, Berlin, Heidelberg (2008)
16. *Simulation von Logistik-, Materialfluss- und Produktionssystemen: Grundlagen*, 3633-1, VDI Verein Deutscher Ingenieure, Berlin (2014)

17. Hedtstück, U.: Simulation diskreter Prozesse: Methoden und Anwendungen. Springer Vieweg, Berlin, Heidelberg (2013)
18. Drews, T.: Zieldeterminierte Gestaltung von Produktionssystemen. Dissertation. Shaker Verlag GmbH, Düren (2019)
19. Nyhuis, P.: Entwicklungsschritte zu Theorien der Logistik. In: Nyhuis, P. (ed.) Beiträge zu einer Theorie der Logistik, pp. 1–18. Springer-Verlag, Berlin Heidelberg, Berlin, Heidelberg (2008)
20. Nyhuis, P., Wiendahl, H.-P.: Logistische Kennlinien: Grundlagen, Werkzeuge und Anwendungen, 3rd edn. Springer Vieweg, Berlin (2012)
21. Balci, O.: How to assess the acceptability and credibility of simulation results. In: Proceedings of the 1989 Winter Simulation Conference, Washington, D.C., United States, pp. 62–71 (1989)
22. Asif, F.M., Roci, M., Lieder, M., Rashid, A., Mihelič, A., Kotnik, S.: A methodological approach to design products for multiple lifecycles in the context of circular manufacturing systems. *J. Clean. Prod.* **296**, 126534 (2021)
23. Roci, M., et al.: Towards circular manufacturing systems implementation: a complex adaptive systems perspective using modelling and simulation as a quantitative analysis tool. *Sustainable Prod. Consump.* **31**, 97–112 (2022)
24. Borshchev, A.: The Big Book of Simulation Modeling: Multimethod Modeling With AnyLogic 6. AnyLogic North America, Chicago (2013)

**Open Access** This chapter is licensed under the terms of the Creative Commons Attribution 4.0 International License (<http://creativecommons.org/licenses/by/4.0/>), which permits use, sharing, adaptation, distribution and reproduction in any medium or format, as long as you give appropriate credit to the original author(s) and the source, provide a link to the Creative Commons license and indicate if changes were made.

The images or other third party material in this chapter are included in the chapter's Creative Commons license, unless indicated otherwise in a credit line to the material. If material is not included in the chapter's Creative Commons license and your intended use is not permitted by statutory regulation or exceeds the permitted use, you will need to obtain permission directly from the copyright holder.





# Concept of Sustainable Supply Chain Management Using Multi-agent System: Negotiation by Linear Physical Programming

Jundai Koketsu<sup>1</sup>, Aya Ishigaki<sup>1</sup> (✉), Hiromasa Ijuin<sup>2</sup>, and Tetsuo Yamada<sup>2</sup>

<sup>1</sup> Tokyo University of Science, Noda, Chiba, Japan  
ishigaki@rs.tus.ac.jp

<sup>2</sup> The University of Electro-Communications, Chofu, Tokyo, Japan

**Abstract.** Industry and academia are both making efforts to realize a sustainable society; an important part of these efforts is to ensure the sustainability of the supply chains that support our daily life. Sustainable supply chains are more complex than traditional supply chains, and they involve a combination of multiple issues. Multiple plans must be used to deal with these issues. However, these plans often conflict with each other. To manage a sustainable supply chain, an integrated approach is needed to operate multiple plans for multiple issues.

This paper introduces a research concept for integrated sustainable supply chain management using a multi-agent system. An agent executing a plan for an issue autonomously negotiates with other agents and avoids conflicts. Linear physical programming used for negotiation balances agents' utility and ensures that all plans function well. Through this research, we provide an example of the simultaneous operation of multiple plans in a sustainable supply chain, aiming at the social implementation of sustainable supply chains.

**Keywords:** Research concept · Decision making · Linear physical programming · Negotiation process

## 1 Introduction

In recent years, concerns about the depletion of natural resources and the emergence of environmental problems have heightened the need for sustainable production and consumption. In particular, the supply chain (SC), which is the basis of production and consumption, needs to become a sustainable supply chain (SSC) that is economically viable as a business while taking the environment into consideration.

In a conventional linear SC, the amount consumed is directly related to the amount sold, resulting in a trade-off between the environment and the economy. Therefore, a typical example of SSC is the closed-loop supply chain (CLSC), which adds the process of collecting and reusing used products to the conventional SC. However, to operate the CLSC sustainably, it is necessary to deal with the problems associated with the uncertain recovery of used products, in addition to the demand fluctuations and other problems

associated with conventional SCs. This means that sustainable supply chain management (SSCM) requires more problem-solving capabilities than conventional SCM.

SSCM has been an active field of research. Ghadimi et al. [1] studied the supplier selection and order allocation problem using multi-agent technology to make the supply chain sustainable. Takahashi et al. [2] proposed an adaptive pull strategy that changes the manufacturing and remanufacturing speed according to various inventory levels as a management method for SSCs. Other areas of research include the location routing problem for SSCs [3] and dynamic pricing of products according to reuse rates [4]. Thus, previous studies have focused on one phase of SSCs, such as maintenance, recovery, and remanufacturing, in addition to parts supply, manufacturing, transportation, and sales. However, when SSC is actually implemented, each of these issues is not independent of the other, and it is necessary to deal with problems that occur in combination. Goltsov et al. [5] argued that it was necessary to synchronize and coordinate the three planning processes of forecasting, collection, and inventory and production control to deal with the problems that arise in SSC. To implement SSC and realize a sustainable society, we believe that an integrated SSCM (ISSCM) is necessary to synchronize and link not only the three above-mentioned processes but also the SSCMs that are being developed separately at each stage.

Synchronization and coordination of multiple SSCMs is not a simple task. For example, changing the manufacturing or remanufacturing speed will change the transportation requirements. Changing the pricing of a product will affect the profit margins of all members of the SC. Since each SSCM is intended to solve a specific problem and the modeling assumes that other elements will be omitted to some extent, synchronization and coordination can cause various conflicts. SSCMs that ignore conflicts will find it difficult to deal with even a single issue, let alone multiple issues, leading to worsening environmental impacts and economic viability, as well as loss of sustainability. If the weight of each SSCM is unbalanced, the burden may fall on certain members, and the SC may fail. Therefore, a conflict-resolving negotiation process is needed to effectively synchronize and coordinate multiple SSCMs for multiple issues.

This paper introduces the research concept of ISSCM using a multi-agent system. The manufacturers, retailers, collectors, etc., that make up the SSC are considered as agents, each with its own utility and freely changeable plan. Each agent makes planning decisions through inter-agent negotiation so that utility is not significantly impaired. We believe that using this system to provide an example in which all agents execute a plan to solve a problem while maintaining a certain level of utility will support the social implementation of SSC by real decision makers.

## 2 SSC Model Construction Using a Multi-agent System

### 2.1 Effectiveness of Multi-agent System for ISSCM

A multi-agent system (MAS) is an autonomous decentralized system in which multiple agents are aware of their own environment and make decisions and act accordingly. In general, SCM is an approach that comprehensively manages all processes from the procurement of raw materials to the provision of products and services to customers, aiming to improve efficiency, and, therefore, MAS and SCM are not, at first glance,

compatible with each other. However, several studies have suggested combining SCM with MAS. Fox et al. [6] described an integrated SCM (ISCM) architecture that divides the operational level of SCM functions from the strategic level and handles each function in an integrated, rather than an independent, manner. Each function that makes up ISCM is executed by an agent, which makes decisions through coordination with other related agents. Fox et al. assumed an SC in which multiple functions interactively influence each other and employed MAS, an autonomous decentralized system, to manage them. Lou et al. [7] adopted MAS for agile SCM, which involves rapid reconfiguration and adjustment to the SC itself, rather than the traditional line-type SC. MAS, which is more flexible and adaptable than centralized systems, is suitable for agile SCM, which aims to keep changing the constituent companies and scale quickly and appropriately to the environment.

Let us consider the characteristics of ISSCM. SSCs raise more issues than regular SCs because of factors such as recovery and remanufacturing. Since the ISSCM targeted in this study aims to deal with multiple issues at the same time, rather than a single one, it necessarily has multiple functions, requiring coordination between functions. In addition to demand forecasting, SSC involves the uncertainty of used product recovery, which requires flexibility and adaptability when considering how to deal with non-stationary demand and recovery. Therefore, this study will implement ISSCM combined with MAS.

## 2.2 SSC Model Construction

The modeling of SSCs subject to ISSCM is divided into two major steps (see Fig. 1).

Step 1: Definition of the subject of the material flow

Will new and remanufactured products be distinguished; how many echelon inventories will be assumed; and in what detail will attributes such as product quality be handled? In this way, the definition of the material flow for the target SSC is determined. This allows us to design a simulation model of the material flow.

Step 2: Determination of the subject in the information flow.

An agent is defined as an entity that receives information and manages the material flow. Each agent has the ability to recognize the state of its own environment and the simulation model and change the material flow it manages accordingly. For example, when an agent managing remanufacturers becomes aware of a high inventory of recovered products, it decides to increase the number of remanufactures so as to reduce the inventory of recovered products and increase profits. However, if the retailer receiving the remanufactured product has a large inventory, a conflict arises with the agent managing the retailer. Negotiations among agents are conducted to avoid such conflicts and to make each agent's management functions work effectively.

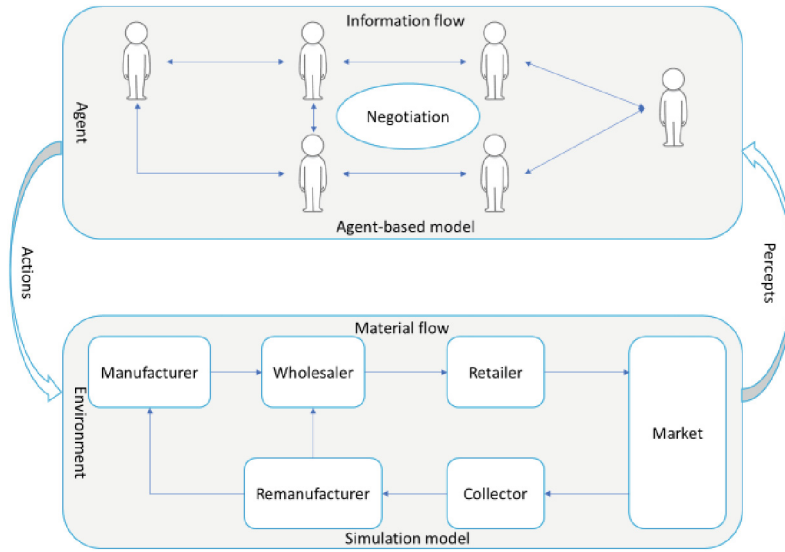


Fig. 1. Conceptual diagram of SSC model for ISSCM

### 3 Agent Decision-Making Process Through Negotiation

#### 3.1 Suriawase Process

One of the negotiated decision-making methods involving multiple negotiation participants with different levels of utility is the Suriawase process [8]. In the Suriawase process, each negotiator presents their best plan as an initial proposal, and through repeated negotiations and goal reviews, a common alternative is developed that satisfies all negotiators. The procedure to be followed is shown below.

Step 1: Each negotiator presents an initial proposal.

Step 2: All negotiators share goals.

Step 3: A solution is created from the given goals.

Step 4: If the solution in Step 3 does not satisfy all negotiators, each participant revises the goals and returns to Step 2.

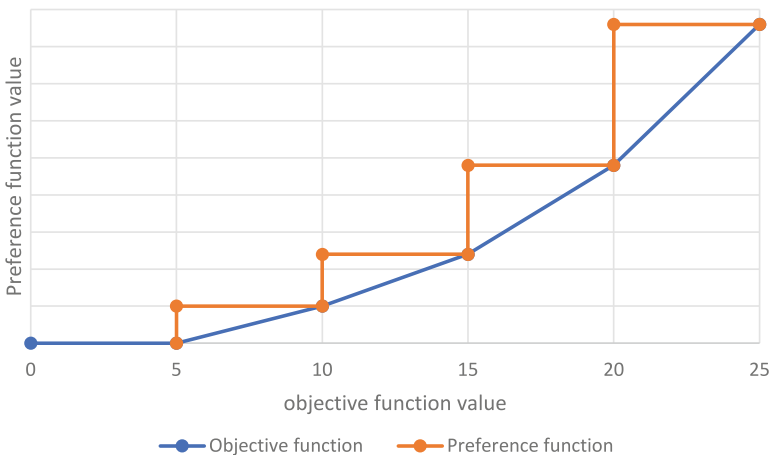
Step 5: A final alternative is determined.

There are two ways to share goals for alternative development. One is Point-based Design (PD), which presents only one reference value for the objective function to be pursued by the negotiation participants. The other is Preference Set-based Design (PSD), which presents multiple reference values as a set according to the preference level. This study's negotiation design follows the model of a PSD to be conducted between agents by using the following method.

### 3.2 Linear Physical Programming

In the Suriawase process, all participants negotiate with each other by presenting target values for their own objective functions. For successful negotiation, we focus on multi-objective optimization methods where the target value is given by each objective function. Goal programming (GP) [9] is known as a multi-objective optimization method. GP corresponds to PD in the Suriawase process. GP defines priorities for each objective and sets weighting coefficients. The optimal solution is obtained by calculating the separation of each objective from the ideal, considering the weighting coefficients, and minimizing the sum. However, it is difficult to set appropriate weighting coefficients in GP. For example, the optimal setting of the weighting coefficients for out-of-stock risk and excess inventory risk in SCM changes constantly depending on the situation. To address this weighting coefficient problem, this study uses linear physical programming (LPP) [10] as a negotiation method between agents. LPP is equivalent to PSD. LPP is characterized by its ability to derive weighted coefficients algorithmically by providing multiple target values and a preference range for each objective. This allows agents to derive weighting coefficients autonomously during negotiations.

Figure 2 shows an example of transforming an objective function for a given objective into a preference function by setting a preference range with multiple target values. LPP aims to minimize the sum of the preference functions for each objective that shows the difference from the ideal. Another feature of LPP is the OVO (One vs. Others) rule. According to this rule, it is better for all preference functions to be equal than for one objective preference function to worsen and all others to improve. This ensures that the obtained solution is balanced by the preference function among all objectives. That is, by making the LPP objective the objective function of each negotiation participant, an alternative can be developed that satisfies all negotiators.

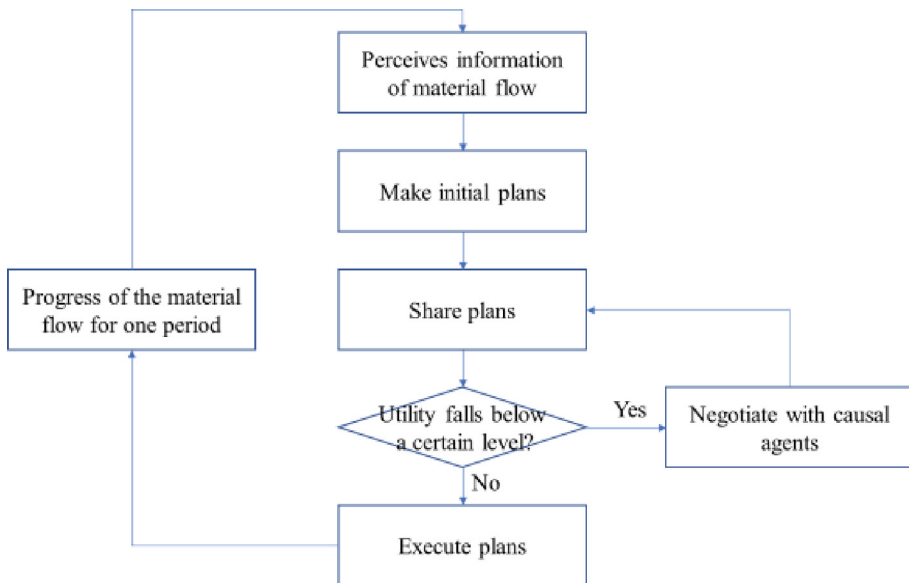


**Fig. 2.** Example of transforming objective function into preference function



### 3.3 Decision-Making Flow of Each Agent

Figure 3 shows the decision-making flow of each agent. Each agent perceives the information (e.g., amount of inventory, expected deliveries, etc.) of the entities (manufacturers, remanufacturers, etc.) in the material flow that it manages. On this basis, it formulates an optimal plan that maximizes its own utility and shares the optimal plan with the agents involved in the plan. Agents whose utility falls below a certain level due to the plans of other agents negotiate with the causal agent to adjust their plans. If, after repeated negotiations, all agents have a certain level of utility, the plan is executed, and the simulation progresses for one period with each agent's decisions reflected in the material flow. By repeating the above, it is possible to effectively combine ISSCM with MAS.



**Fig. 3.** Decision-making flow of each agent

## 4 Conclusion

This paper introduces the research concept of ISSCM using a multi-agent system. To implement SSC in the future, it is essential to operate multiple SSCM plans through an integrated approach, rather than independently. For each plan to operate efficiently, it is necessary to reduce the conflicts that occur among them. Therefore, this research concept aims to operate multiple SSCM plans simultaneously using LPP-based negotiation between agents. Through this research, we believe that we can support the social implementation of SSC by real decision makers by showing an example of execution of multiple plans for multiple tasks, while all agents maintain a certain level of utility.

**Acknowledgment.** This research was partially supported by the Japan Society for the Promotion of Science (JSPS), KAKENHI, Grant-in-Aid for Scientific Research (B), 22H01718 from 2022.

## References

1. An official website of the European Union. [https://ec.europa.eu/info/law/better-regulation/have-your-say/initiatives/12313-European-vehicle-emissions-standards-Euro-7-for-cars-vans-lorries-and-buses\\_en](https://ec.europa.eu/info/law/better-regulation/have-your-say/initiatives/12313-European-vehicle-emissions-standards-Euro-7-for-cars-vans-lorries-and-buses_en). Accessed 22.05.22
2. Souza, G.C.: Closed-loop supply chains: a critical review, and future research. *Decis. Sci.* **44**, 7–38 (2013). <https://doi.org/10.1111/j.1540-5915.2012.00394.x>
3. Zhou, L., Gupta, S.M., Kinoshita, Y., Yamada, T.: Pricing decision models for remanufactured short-life cycle technology products with generation consideration. *Procedia CIRP* **61**, 195–200 (2017). <https://doi.org/10.1016/j.procir.2016.11.208>
4. Raza, S.A.: Greening and price differentiation coordination in a supply chain with partial demand information and cannibalization. *J. Clean. Prod.* **229**, 706–726 (2019). <https://doi.org/10.1016/j.jclepro.2019.04.371>
5. Peng, H., Shen, N., Liao, H., Xue, H., Wang, Q.: Uncertainty factors, methods, and solutions of closed-loop supply chain – a review for current situation and future prospects. *J. Clean. Prod.* **254**, 120032 (2020). <https://doi.org/10.1016/j.jclepro.2020.120032>
6. Takahashi, K., Doi, Y., Hirotani, D., Morikawa, K.: An adaptive pull strategy for remanufacturing systems. *J. Intell. Manuf.* **25**(4), 629–645 (2012). <https://doi.org/10.1007/s10845-012-0710-1>
7. Goltsos, T.E., Ponte, B., Wang, S., Liu, Y., Naim, M.M., Syntetos, A.A.: The boomerang returns? Accounting for the impact of uncertainties on the dynamics of remanufacturing systems. *Int. J. Prod. Res.* **57**, 7361–7394 (2019). <https://doi.org/10.1080/00207543.2018.1510191>
8. Okuda, A., Ishigaki, A., Yamada, T., Gupta, S.M.: Modeling and analysis of a closed-loop supply chain in consideration of extra demand. *Int. J. Autom. Technol.* **12**, 469–481 (2018). <https://doi.org/10.20965/ijat.2018.p0469>
9. Ho, W., Xu, X., Dey, P.K.: Multi-criteria decision making approaches for supplier evaluation and selection: a literature review. *Eur. J. Oper. Res.* **202**, 16–24 (2010). <https://doi.org/10.1016/j.ejor.2009.05.009>
10. Inoue, M., Mogi, R., Nahm, Y.E., Ishikawa, H.: Design support for “Suriawase”: Japanese way for negotiation among several teams. *Improving Complex Syst. Today* 385–392 (2011). [https://doi.org/10.1007/978-0-85729-799-0\\_45](https://doi.org/10.1007/978-0-85729-799-0_45)
11. Yatsuka, T., Ishigaki, A., Kinoshita, Y., Yamada, T., Inoue, M.: Linear physical programming iteration method of multi-player multi-objective decision making supply chain. *Procedia Manuf.* **39**, 1649–1657 (2019). <https://doi.org/10.1016/j.promfg.2020.01.276>
12. Ghadimi, P., Toosi, F.G., Heavey, C.: A multi-agent systems approach for sustainable supplier selection and order allocation in a partnership supply chain. *Eur. J. Oper. Res.* **269**, 286–301 (2018). <https://doi.org/10.1016/j.ejor.2017.07.014>

**Open Access** This chapter is licensed under the terms of the Creative Commons Attribution 4.0 International License (<http://creativecommons.org/licenses/by/4.0/>), which permits use, sharing, adaptation, distribution and reproduction in any medium or format, as long as you give appropriate credit to the original author(s) and the source, provide a link to the Creative Commons license and indicate if changes were made.

The images or other third party material in this chapter are included in the chapter's Creative Commons license, unless indicated otherwise in a credit line to the material. If material is not included in the chapter's Creative Commons license and your intended use is not permitted by statutory regulation or exceeds the permitted use, you will need to obtain permission directly from the copyright holder.





# Designing a Reverse Supply Chain Network for Smartphones with Material-Based GHG Emissions and Costs Using Linear Physical Programming

Hiromasa Ijuin<sup>1</sup>, Takaki Nagao<sup>1</sup>, Masakuni Tsunazawa<sup>2</sup>, Kohei Sugiyama<sup>2</sup>, Kazuyuki Tasaka<sup>2</sup>, and Tetsuo Yamada<sup>1</sup> (✉)

<sup>1</sup> Department of Informatics, The University of Electro-Communications, 1-5-1 Chofugaoka, Chofu-shi, Tokyo 182-8585, Japan

{i2040014, n2130089}@edu.cc.uec.ac.jp, tyamada@uec.ac.jp

<sup>2</sup> R&D Planning Division, KDDI Research Inc., 2-1-15 Ohara, Fujimino-shi, Saitama 356-8502, Japan

{ma-tsunazawa, ko-sugiyama, ka-tasaka}@kddi.com

**Abstract.** Currently, levels of production and disposal for communication devices such as smartphones are continuing to increase. In the life cycle of a smartphone, the majority of greenhouse gas (GHG) emissions are generated in the material production stage. To recover the GHG emissions from end-of-life (EOL) products such as smartphones, manufacturers have to recycle EOL products. However, smartphones on the market undergo little recycling because costs related to recycling, transportation, and facilities are very high. Therefore, the decision maker (DM) has to design a reverse supply chain network for collecting EOL products from users and transporting them to recovery or disposal facilities not only environmentally friendly but also economically feasible. This study applies a bi-objective reverse supply chain network design to material-based GHG volumes and related costs applying a multi-criteria decision-making methods as linear physical programming (LPP) to design a reverse supply chain network in the case of smartphones. First, the reverse supply chain network is modeled for recycling EOL smartphones, and a case study based on literatures and life cycle assessment are prepared. Next, the objective functions are set and formulated to minimize the total volume of material-based GHG volume and the total cost using LPP and integer programming. Finally, numerical experiments on the reverse supply chain are conducted and evaluated.

**Keywords:** Reverse Logistics · Carbon Recovery · Multi-Criteria Decision Making · Life Cycle Assessment · Recycling

## 1 Introduction

At the present time, many communication devices such as smartphones are being produced. According to a survey conducted by IDC, the number of smartphones shipped

worldwide reached 1.35 billion in 2021 [1]. Such large-scale product distribution is not only associated with significant economic benefits, but also has a major environmental impact. According to the research of SHARP [2], the CO<sub>2</sub> emissions sometimes account for more than 90% of the CO<sub>2</sub> emissions for electric products and home appliances in supply chains consisting of parts/materials manufacturing, assembly manufacturing, and logistics stages. Therefore, the CO<sub>2</sub> emissions of original material production should be concerned, and the end-of-life (EOL) products should be recycled for a significant reduction in greenhouse gas (GHG) emissions by replacing new products with recycled ones [3].

Nevertheless, the smartphones currently on the market undergo very little recycling. For example, the smartphone recycling rate is only 17% in Japan [4]. This fact means that most of the smartphones are not recycled. One of the reasons for the low recycling rate is that manufactures require the additional costs such as recycling, transportation, and recovery facility costs to construct the reverse supply chain network. The costs of reverse supply chain are based on the network configuration, and the company decides the network for reducing costs. When the reverse supply chain network is changed, the amount of recycling or disposal EOL products is also changed. One of the reasons is that the recycling EOL smartphones is a difficult challenge because the material composition of these devices is complicated. It includes valuable metals that can be recycled but also plastics with no recycling value. The selling prices obtained from recycled materials are different depending on the material type. This makes it difficult for decision-makers (DMs) at manufacturers to design a reverse supply chain network that takes into account the costs associated with recycling processes (e.g., collection, disassembly, and transportation), and the prices (value) of each recycled material. Furthermore, recycling more EOL products and reducing cost for the reverse supply chain are in a trade-off relationship. Therefore, the DMs need to design a reverse supply chain network [5] that is not only environmentally friendly but also economically feasible by performing a complicated profit and cost calculation.

Thies et al. [6] reviewed 142 papers on sustainably assessment related products applied operations research. They showed more than 50% literatures used multi-criteria decision making methods. However, they concluded that there were few attentions for using the model of operations research to sustainability assessment of products. Aldoukhi and Gupta [7] designed a global closed-loop supply chain considering to minimize total cost a carbon emission and to maximize service level of retailers. However, they did not consider materials such as plastic and aluminum obtained from recycling EOL products. In an effort to evaluate GHG emissions from smartphones, Joshi et al. [3] investigated the GHG emissions caused by a smartphone over all its life stages. However, the economic efficiency of the reverse supply chain network was not evaluated.

In order to consider both GHG emissions and economic efficiency, Ijuin et al. [8] have applied linear physical programming (LPP) [9] to a reverse supply chain network in the case of vacuum cleaners. LPP is one of the multi-criteria decision-making methods that enable us to not only optimize the network taking into account the trade-off problem between GHG emissions and economic efficiency, but also to determine weights among objective functions by applying the LPP weight algorithm. According to Ijuin et al. [8], one of the benefits is that LPP can find one satisfied solution among multi objective

functions such as the minimizing total cost and total GHG emissions based on the preferences of the DM with a lower number of experimental trials. The limitation of the LPP approach is that alternative and multiple results from pareto solution cannot be obtained to see the trade-offs.

On the other hand, while smartphones are composed of different components, they are usually made in a single country, but the sourcing country for the components varies from smartphone to smartphone. Since the GHG emissions of components and devices in production differ among countries [10], the GHG emissions associated with a particular smartphone are different depending on the country. Therefore, the differences in the reverse supply chain network should be considered in relation to the country manufacturing the components.

This study applies a bi-objective reverse supply chain network design to the GHG volume and costs using LPP for the case of smartphones. First, the reverse supply chain network is modeled for recycling EOL smartphones, and a case study based on literatures and life cycle assessment (LCA) are prepared. Next, the objective functions are set and formulated to minimize the total GHG volume and the total cost using LPP and integer programming. Finally, numerical experiments on the reverse supply chain are conducted and evaluated.

## 2 Model and Formulation

### 2.1 Model

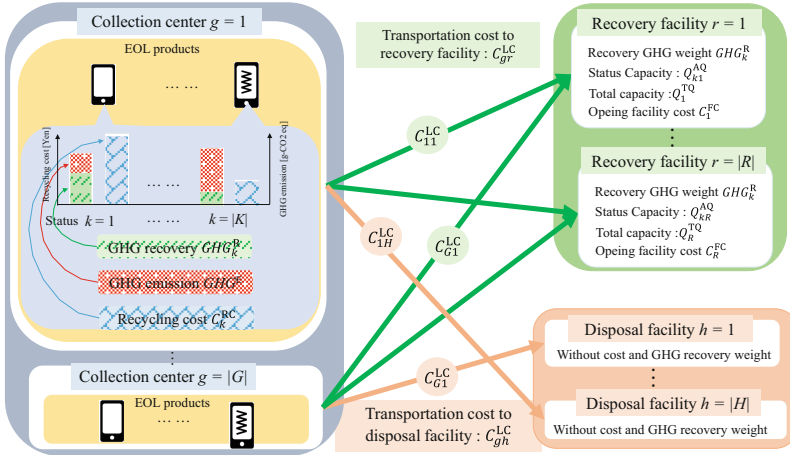
Figure 1 shows the reverse supply chain network modeled for recycling EOL smartphones. Similar to Ijuin et al. [11], the model consists of collection centers  $G$ , recovery facilities  $R$ , and disposal facilities  $H$ .

In the collection center  $g(\in \{1, \dots, |G|\})$ , EOL smartphones are collected with the status  $k(\in \{1, \dots, |K|\})$ . The status  $k$  determines the GHG recovery weight  $GHG_k^R$  and the recycling cost  $C_k^{RC}$  for recycling. The GHG recovery weight  $GHG_k^R$  refers to the GHG recovery amounts during the recycling stage. The recycling cost  $C_k^{RC}$  is the difference between the cost incurred for disassembly of the EOL product and the sales revenue made from the sale of the recovered materials.

The EOL smartphone with status  $k$  is transported from collection center  $g$  to the recovery facility  $r(\in \{1, \dots, |R|\})$  or disposal facility  $h(\in \{1, \dots, |H|\})$ , with a transportation cost of  $C_{gr}^{LC}$  and  $C_{gh}^{LC}$ , respectively. These transportation costs are determined by the distance between the collection center  $g$  and recovery facility  $r$ , or  $g$  and the disposal facility  $h$ . In the recovery facility  $r$ , the smartphone with status  $k$  is recycled with a recycling cost  $C_k^{RC}$ . This is the cost to disassemble the EOL smartphone and takes the sales price of the recycled smartphone into account. When the smartphone is recycled, the amount of GHG volume is also reduced proportional to weight  $GHG_k^R$ . In the disposal facility  $h$ , there are no recycling costs or recovery of GHG emissions.

### 2.2 Variables and Parameters

Based on Ijuin et al. [11], the GHG volume  $TGHG$  and the total cost  $TC$  as objective functions are set using integer programming [12]. The number of products with status  $k$



**Fig. 1.** Reverse supply chain network model in the case of smartphones.

transported from the collection center  $g$  to the recovery facility  $r$  and the disposal facility  $h$  is represented by  $v_{grk}$  and  $v_{ghk}$ , respectively. The binary value  $u_r$  is the decision variable to open a recovery facility  $r$ . Total cost  $TC$  is calculated by using the transportation numbers  $v_{grk}$  and  $v_{ghk}$ , and the decision variable to open recovery facilities. The number of collected EOL products at collection center  $g$  is represented by  $Q_g^{CQ}$  while the number of products with status  $k$  and recycled at the recovery facility  $r$  is represented by  $x_{kr}$ .

The total cost  $TC$  is calculated by summing the recycling cost  $C_k^{RC}$ , transportation cost  $C_{gr}^{LC}$  and,  $C_{gh}^{LC}$  for an EOL product, and the cost for opening recovery facility  $C_r^{FC}$  in the reverse supply chain network as shown in Eq. (1). The total GHG volume  $TGHG$  is calculated by subtracting the GHG recovery weight of a product with status  $k$   $GHG_k^R$  and GHG emissions  $GHG^E$ , which is the GHG emissions weight in the manufacturing stage as shown in Eq. (2).

$$TC = \sum_{g \in G} \sum_{r \in R} \sum_{k \in K} \left( C_k^{RC} + C_{gr}^{LC} \right) v_{grk} + \sum_{g \in G} \sum_{h \in H} \sum_{k \in K} C_{gh}^{LC} v_{ghk} + \sum_{r \in R} C_r^{FC} u_r \quad (1)$$

$$TGHG = \sum_{g \in G} GHG^E Q_g^{CQ} - \sum_{r \in R} \sum_{k \in K} GHG_k^R x_{kr} \quad (2)$$

To apply LPP [9] to a reverse supply chain network, two objective functions, related to the total material-based GHG volume  $TGHG$  and total cost  $TC$ , are aggregated into a single function as shown in Eq. (3). Each objective function  $i$  is divided into five limits  $t_{i,s}^+$  ( $s = 1, 2, 3, 4, 5$ ), where, based on the divided ranges, six ranges referred to as “Ideal” (Under  $t_{i,1}^+$ ), “Desirable” ( $t_{i,1}^+ \sim t_{i,2}^+$ ), “Tolerable” ( $t_{i,2}^+ \sim t_{i,3}^+$ ), “Undesirable” ( $t_{i,3}^+ \sim t_{i,4}^+$ ), “Highly Undesirable” ( $t_{i,4}^+ \sim t_{i,5}^+$ ), and “Unacceptable” (Over  $t_{i,5}^+$ ) are decided. In Eq. (3),  $\tilde{w}_{is}^+$  is the weight parameter for objective function  $i$  and range  $s$  based on each limit  $t_{i,s}^+$ . The regression value for all objective functions is multiplied by the deviation

$d_{is}^+$  and weight parameter  $\tilde{w}_{is}^+$  for each objective function.

$$\sum_{i \in I} \sum_{s=\{2,3,4,5\}} \tilde{w}_{i,s}^+ d_{i,s}^+ \rightarrow \min \quad (3)$$

As the first objective function, the 1st deviation  $d_{1,s}^+$  of the total cost  $TC$  is determined under the constraint Eq. (4), where the total cost  $TC$  needs to be lower than the limit of unacceptable (Over  $t_{1,s}^+$ ), as shown in Eq. (5). In the literature of LPP definition [9], the constraint of the derivation is mentioned as “ $s = 2, \dots, 5$ ”. Equations (4) and (6) evaluate the difference among each objective function and aspiration levels. Since  $s = 1$  means the aspiration level of ideal representing best solution range, the difference of each objective function is not required to be evaluated.

$$TC - d_{1,s}^+ \leq t_{1,s-1}^+ \quad s = 2, \dots, 5 \quad (4)$$

$$TC \leq t_{1,5}^+ \quad (5)$$

As the second objective function, the 2nd deviation  $d_{2,s}^+$  for the total GHG volume  $TGHG$  is determined from the constraint Eq. (6), where the total GHG volume  $TGHG$  needs to be lower than the limit of unacceptable  $t_{2,5}^+$ , as shown in Eq. (7).

$$TGHG - d_{2,s}^+ \leq t_{2,s-1}^+ \quad s = 2, \dots, 5 \quad (6)$$

$$TGHG \leq t_{2,5}^+ \quad (7)$$

### 3 Case Study

To design a reverse supply chain network for collecting and recycling smartphones using LPP, following assumptions are prepared based on the study of Ijuin et al. [11].

- Product example and global material scenario
  - In a material manufacturing stage, types and weight of materials are assumed within a smartphone based on a survey and material-based GHG emissions visualization tool [13]. There are mainly four materials contained in the products [14] as follows: copper (Cu), ABS, glass, and a lithium ion battery (LIB). By using the material-based GHG emissions visualization tool developed by Umata et al. [13], GHG emissions when manufacturing the materials depending on countries within smartphone’s components are estimated by life cycle assessment [15].
  - As global material scenarios, there are two global scenarios are assumed and compared depending on material manufacturing country as follows.

Scenario 1: Materials within components of a smartphone are manufactured in country A, where material-based GHG emissions are lower while procurement costs are higher than them manufactured in country B.

Scenario 2: Materials within components of a smartphone are manufactured in country B, where material-based GHG emissions are higher but procurement costs are lower than them manufactured in country A.



- In recycling stage for an EOL smartphone, three product statuses are assumed for their GHG recovery volume  $GHG_k^R$  and recycling cost  $C_k^{RC}$ , as shown in Table 1. The recycling cost  $C_k^{RC}$  is the difference between the disassembly cost and the sales revenue of the recovered material.
- Reverse supply chain example
  - Similar to Ijuin et al. [11], it is assumed that there are two collection centers ( $G = \{1, 2\}$ ), three recovery facilities ( $R = \{1, 2, 3\}$ ) and one disposal facility ( $H = \{1\}$ ) as an example of facilities.
  - Each collection center has 3,000 EOL smartphones with each status ( $K = \{1, 2, 3\}$ ), thus, total 9,000 ( $Q_g^{CQ} = 9,000$ ) EOL products exist. Each recovery facility has recyclable EOL products depending on the EOL product status.

**Table 1.** Recycling cost and GHG recovery volume for each status

Status $k \in K$	GHG recovery volume $GHG_k^R$ [g-CO <sub>2</sub> eq]		Recycling cost $C_k^{RC}$ [Yen]
	Country A	Country B	
$k = 1$ Recycling all components	53,121	77,252	269.90
$k = 2$ Recycling Cu and LIB components	53,085	77,198	169.88
$k = 3$ Recycling Cu components	90	113	72.87

## 4 Result

To evaluate the values of total GHG volume  $TGHG$  and total cost  $TC$  for a reverse supply chain network design, a numerical experiment is conducted using the LPP developed in Sect. 2 for the two scenarios described in Sect. 3.

Figure 2 shows the result of the total GHG volume and total cost on countries A and B in the case of smartphones, while Table 2 represents the obtained aspiration level for each objective function. In the case of country A, GHG emissions for components are less than the GHG emissions in country B. Even if all EOL products having status 1 are not recycled, the aspiration level for the GHG volume became “Tolerable”. Therefore, since recovery facility 1, which can recycle EOL products having status 1, is not operating, the preference level of total cost came within the “Desirable” range. In the case of country B, due to the opening of recovery facility 1, the total cost is by 94% higher than one in country A. However, the GHG volume in country B is by 8% lower than one in country A.

Additionally, the total transportation cost between countries A and B is different as shown in Fig. 2. Since material-based GHG emissions for the products manufactured in country B are higher than ones in country A, a larger number of the EOL products manufactured in country B should be collected and recycled to increase the total GHG recovery volumes. However, due to the production capacity at each facility, some of the EOL products manufactured in country B should be transported to a far recovery facility for recycling. Therefore, the transportation and recycling cost for the smartphones manufactured in country B become higher by 65% and 96%, respectively, than ones in country A.

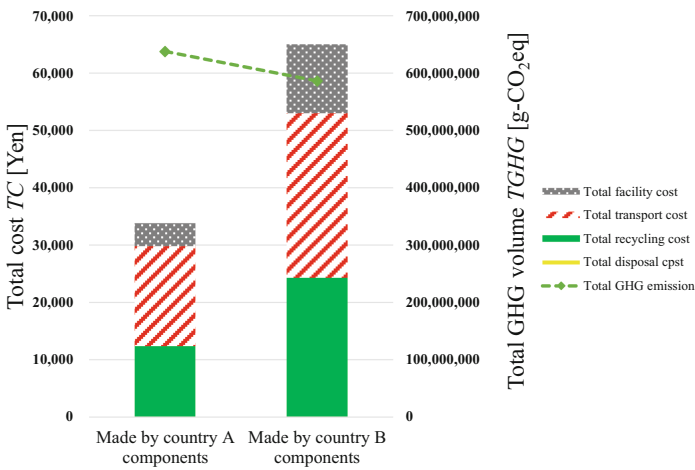


Fig. 2. Result of the total GHG volume and total cost on countries A and B

Table 2. Aspiration level for each objective function for countries A and B

Objective function	Country A		Country B	
	Value	Aspiration level	Value	Aspiration level
Total cost $TC$ [Yen]	3,382,400	Desirable	6,499,900	Tolerable
Total GHG volume $TGHG$ [g-CO <sub>2</sub> eq]	637,679,000	Tolerable	586,204,000	Tolerable

Regarding the EOL product having status 1, 74% (4,416 out of 6,000 EOL smartphones having status 1 are recycled) of EOL products manufactured solely in country B are recycled. One of the reasons is that the GHG emissions of a product  $GHG^E$  in country B are by 45% higher than ones in country A. All EOL products having status 2 are recycled in the recovery facility 2, which is closer from collection centers than the recovery facility 1. For EOL products with the status 3, only those near the recovery facility 3 are recycled from the collection center, and the others are disposed of.

## 5 Conclusion

This study applied a bi-objective reverse supply chain network design to the GHG volume and costs applying LPP to the case of smartphones. For EOL smartphones, it was found that the EOL products with high GHG emissions should be transported to a far recovery facility for recycling. One of the managerial insights is that the products manufactured in the country with low GHG emissions are economical than ones in the country with high GHG emissions when considering the recycling stage. Regarding the reverse supply chain network, the EOL products need to be recycled in a nearby facility due to transportation costs.

Future studies should consider recycling mixed products in a reverse supply chain scenario and measure the reverse supply chain network by using net present value (NPV).

**Acknowledgement.** This study was partially supported by the Japan Society for the Promotion of Science (JSPS), KAKENHI, Grant-in-Aid for Scientific Research (A), JP18H03824, from 2018 to 2023 and Grant-in-Aid for JSPS Research Fellow, 22J10329, from 2022 to 2023.

## References

1. IDC Corporation, Smartphone Shipments Declined in the Fourth Quarter But 2021 Was Still a Growth Year with a 5.7% Increase in Shipments. <https://www.idc.com/getdoc.jsp?containerId=prUS48830822>. Accessed 22 Mar 2022
2. Sharp, Environmental Report 2002. <http://www.sharp.co.jp/corporate/eco/report/backnumber/pdf/esr2002e.pdf>. Accessed 16 May 2016
3. Joshi, A., Gupta, A., Verma, S., Paul, A.R., Jain, A., Haque N.: Life cycle based greenhouse gas footprint assessment of a smartphone. In: International Conference on Sustainable Energy, Environment and Green Technologies 2021. IOP Publishing (2021)
4. PR Times Inc.: The recycling recovery rate of smartphones is 17%. To Recycle Urban Mine Smartphones. <https://prtimes.jp/main/html/rd/p/000000006.000070388.html>. Accessed 22 Mar 2022. (in Japanese)
5. Battaïa, O., Gupta, S.M.: Reverse supply chains: a source of opportunities and challenges. *J. Manuf. Syst.* **37**, 587–588 (2015)
6. Thies, C., Kieckhäfer, K., Spengler, T.S., Sodhi, M.S.: Operations research for sustainability assessment of products: a review. *Eur. J. Oper. Res.* **274**, 1–21 (2019)
7. Aldoukhi, M., Gupta, S.M.: Use of maximal covering location problem to design a closed loop supply chain network under product substitution. *Appl. Manag. Sci.* **20**, 71–96 (2020)
8. Ijuin, H., Kinoshita, Y., Yamada, T., Ishigaki, A., Inoue, M.: Designing reverse supply chain network with costs and recycling rate by using linear physical programming. *Int. J. Smart Comput. Artif. Intell.* **3**(2), 57–76 (2019)
9. Messac, A., Gupta, S.M., Akbulut, B.: Linear physical programming: a new approach to multiple objective optimization. *Int. Trans. Oper. Res.* **8**, 39–59 (1996)
10. Urata, T., Yamada, T., Itubo, N., Inoue, M.: Global supply chain network design and Asian analysis with material-based carbon emissions and tax. *Comput. Ind. Eng.* **113**, 779–792 (2017)

11. Ijuin, H., Kioshita, Y., Yamada, T., Ishigaki, A.: Designing of individual material recovery in reverse supply chains using linear physical programming at digital transformation edge. *J. Japan Ind. Manag. Assoc.* **72**(4E), 259–271 (2022)
12. Hillier, F.S., Lieberman, G.J.: *Introduction to Operations Research*, 8th edn. McGraw-Hill, New York (2005)
13. Umeta, K., Kondo, R., Kinoshita, Y., Yamada, T., Yamada, S., Inoue, T.: Development of a decision support tool for GHG emissions and procurement costs with material recommendation. *J. Japan Soc. Design Eng.* **55**(4), 277–294 (2020). (in Japanese)
14. Singh, N., Duan, H., Yin, F., Song, Q., Li, J.: Characterizing the materials composition and recovery potential from waste mobile phones: a comparative evaluation of cellular and smart phones. *ACS Sustain. Chem. Eng.* **6**(10), 13016–13024 (2018)
15. Itsubo, N., Tahara, K., Narita, N.: *Introduction of LCA*. Japan Environmental Management Association for Industry, Tokyo (2007). (in Japanese)

**Open Access** This chapter is licensed under the terms of the Creative Commons Attribution 4.0 International License (<http://creativecommons.org/licenses/by/4.0/>), which permits use, sharing, adaptation, distribution and reproduction in any medium or format, as long as you give appropriate credit to the original author(s) and the source, provide a link to the Creative Commons license and indicate if changes were made.

The images or other third party material in this chapter are included in the chapter's Creative Commons license, unless indicated otherwise in a credit line to the material. If material is not included in the chapter's Creative Commons license and your intended use is not permitted by statutory regulation or exceeds the permitted use, you will need to obtain permission directly from the copyright holder.



# **Machine Tools**



# Influence of Additivation of Bio-Based Lubricants on Sprayability and Solubility for Cryogenic Minimum Quantity Lubrication

Trixi Meier<sup>(✉)</sup>, Michael Lermer, Daniel Gross, and Nico Hanenkamp

Institute of Resource and Energy Efficient Production Systems (REP),  
Friedrich-Alexander-Universität Erlangen-Nürnberg, Dr.-Mack-Str. 81 | Technikum 1, 90762  
Fürth, Germany  
trixi.meier@fau.de

**Abstract.** The development of innovative cooling lubrication strategies is significantly driven by the need to machine materials resistant to high temperatures while taking into account both ecological and economic aspects. Cryogenic minimum quantity lubrication (CMQL) represents a compromise satisfying both efficiency and sustainability in the manufacturing process. A minimal amount of oil is added to the cryogenic medium carbon dioxide (CO<sub>2</sub>) to ensure both cooling and lubrication during tool engagement. In this context, vegetable oils, so-called triglycerides, can be used with respect to the cooling lubrication concept. The aim of this paper is to analyze various bio-based oils with regard to their solubility, spraying and flow behavior and to investigate the influence of additives on the performance. During the lubrication tests, the additives have shown no influence on the lubricating effects. Thus the chemical properties of the base oils primarily influence the properties with regard to solubility and spray behavior. Finally, the collected results were correlated with machining tests showing only a limited correlation with the aforementioned lubrication tests.

**Keywords:** CMQL · Milling · Liquid carbon dioxide · Bio-based lubricants

## 1 Introduction

In order to meet the growing demands on machining in the form of cutting high-temperature steels and alloys in the future, cooling lubrication is a central point of reference. Since conventional cooling lubrication strategies have a negative impact on economic and ecological factors as well as on the health of the user, CMQL adds a minimal amount of oil to the cryogenic medium CO<sub>2</sub> in order to ensure not only cooling of the contact zone but also sufficient lubrication. The CO<sub>2</sub>, which has a nozzle outlet temperature of  $T = -78.5$  °C, can be combined with bio-based oils, for example with triglycerides. To optimize the tribological properties of these bio-based oils, they can be mixed with additives. In order to become aware of the properties of the two media CO<sub>2</sub> and oil on the way to the tool cutting edge, selected lubricant tests will be carried out in this study. A possible influence of the lubricant additives sulphur and phosphor on the sprayability and solubility of the lubricant will also be investigated.

© The Author(s) 2023

H. Kohl et al. (Eds.): GCSM 2022, LNME, pp. 139–147, 2023.

[https://doi.org/10.1007/978-3-031-28839-5\\_16](https://doi.org/10.1007/978-3-031-28839-5_16)

## 2 State of the Art

This chapter provides a brief overview of the state of the art on bio-based lubricants and their additives. Furthermore, the solubility of bio-based oils in CO<sub>2</sub> and their benefits for CMQ are discussed in more detail.

### 2.1 Bio-Based Lubricants

Biological lubricants are a sustainable alternative to mineral-based end products. According to DIN 1607, the proportion of renewable raw materials in a lubricant must be at least 25 percent to qualify as biological. Furthermore, the biodegradability of the lubricating oils must be more than 60 percent, which is positively influenced by short carbon chain lengths, for example. In addition, it is possible to add toxic additives to bio-based oils, which do not correspond to a biological origin [1, 2].

### 2.2 Characterization of Lubricant Additives

Extreme pressure (EP) additives and anti-wear (AW) additives are the most relevant representatives of additives that act chemically on the surface. These additives consist on the one hand of a polar component, which actively contacts the surface of the workpiece, and on the other hand of a carbon chain, which determines the solubility of the additive in water [3].

EP additives were specially developed for applications involving high temperature and pressure ranges and form an additional lubricating film in the contact zone by means of chemical compounds. AW additives also bind chemically to the molecular structure of metallic surfaces and thus form a stable protective layer, which prevents premature wear [4, 5]. In the context of this publication, the two components sulphur and phosphor are added to the biological base oils and in addition, chlorine or solids are also typical lubricant additives. Sulphur belongs to the category of EP additives, whereas phosphor corresponds to an AW additive. The various components in the additives each have specific temperature ranges, referred to as activation temperatures, in which they reliably reduce friction within the contact zone. Accordingly, sulphur is active in the temperature range between 500 °C and 1000 °C, whereas phosphor effectively reduces friction between 200 °C and 900 °C [6, 7].

### 2.3 Solubility of Bio-Based Lubricants in CO<sub>2</sub>

In order to be able to understand the processes during the joint feed of the media CO<sub>2</sub> and bio-based oil, the solubility of the two media is relevant in the case of a one-channel CMQL-system. In general, the interaction between the molecules, the so-called polarity, is decisive for the solubility. Accordingly, polarity describes a charge shift within a molecule, which in the case of polar substances leads to a permanent spatial charge separation in the form of continuously acting dipoles. In summary, it can be stated that polar substances dissolve well in polar solvents and, conversely, non-polar substances dissolve well in non-polar solutions. In addition to polarity, temperature also

influences the solubility behavior. High temperatures promote the solubility of solids and liquids, but reduce the solubility of gaseous media in liquid substances. Depending on the thermodynamic state variables pressure  $p$ , temperature  $T$  or volume  $V$ , the state of the mixture can be determined as a function of the mass fractions involved. In addition to a homogeneous mixture, a miscibility gap usually occurs at certain mass fractions and temperatures. If this is the case, the two media are present as separate phases in a heterogeneous mixture [8].

The dissertation by Jörg Fahl can be mentioned as basic research in the field of solubility of various lubricants in  $\text{CO}_2$ . He recognized that the mixing behavior of the two media oil and  $\text{CO}_2$  is influenced not only by polarity and permittivity (polarizability) but also to a large extent by the structure of the lubrication oils [9].

In his publication «Media Flow Analysis of Single-Channel Pre-Mixed Liquid  $\text{CO}_2$  and MQL in Sustainable Machining», Grguras describes the application-related investigation of two lubricants (non-polar and polar) with regard to solubility in  $\text{CO}_2$ . The non-polar oil dissolved better in  $\text{LCO}_2$  than the polar oil. Also, smaller droplet size after nozzle exit could be observed with the non-polar lubricant [10].

In previous studies of the REP chair, the influence of ten bio-based base oils on sprayability and solubility with CMQL has already been investigated with the help of specially developed high-pressure cells. It was shown that the solubility is not determined by the polarity alone [11].

## 2.4 CMQL with Bio-Based Lubricant

CMQL represents a combination of cryogenic cooling and minimum quantity lubrication technology.  $\text{CO}_2$  is used as the cryogenic medium in this investigation. Together with  $\text{LN}_2$ ,  $\text{CO}_2$  represents the most common cryogenic media in machining. The starting point of  $\text{CO}_2$  for CMQL is in riser bottles in which a pressure of  $p = 57.3$  bar and room temperature prevails. This condition is below the critical point on the vapor pressure curve. Consequently, both liquid  $\text{CO}_2$  ( $\text{LCO}_2$ ) and gaseous  $\text{CO}_2$  can be identified within the feed line. During nozzle exit, another cooling effect occurs, which is known in science as the Joule-Thomson effect. This is based on the expansion of a throttled gas whereby the  $\text{CO}_2$  further loses temperature. [12].

In order to be able to feed the bio-based lubricant and the cryogenic medium  $\text{CO}_2$  to the processing zone in a single channel, a CMQL mixing unit was developed in 2015 at the REP department, which enables a single-channel hybrid supply of the two media. In his publication «Milling of Ti6Al4V with carbon dioxide as carrier medium for minimum quantity lubrication with different oils», Gross investigated eight different oils in single-channel application with  $\text{CO}_2$ . In addition to fatty alcohols, mineral oils, synthetic and natural esters were also used. With vegetable and natural esters, the longest tool life was achieved with CMQL [13]. The investigations on the use of bio-based oils for CMQL were continued in detail at the REP Chair and the influence of the oils and their additivation on drilling, milling and turning of stainless steel and roller bearing steel is examined. There is high potential in the use of natural esters for CMQL compared to conventional flood cooling with regard to tool life, wear and forces [14, 15].



### 3 Experimental Setup

In this chapter, the experimental setup for the solubility and sprayability tests is described. Furthermore, the CMQL system used and the oils investigated are explained.

#### 3.1 CMQL-System and Oils

The CMQL system, developed at the REP, consists of an HPLC pump (oil flow regulation), a coriolis sensor (CO<sub>2</sub> flow measurement) and an oil reservoir and operates at approx. 57 bar. It is described in «Hybrid supply system for conventional and CO<sub>2</sub>/MQL-based cryogenic cooling» [16]. In course of this lubricant investigations, 17 additivated test oils are compared experimentally. Eight base oils form the basis for the various additivated configurations. The base oils can be assigned to the groups: hydrocarbons (KW), natural esters (NE) and synthetic esters (SE). The natural esters used consist of rapeseed, coconut and sunflower oil. For additivation, the base oils are mixed with various proportions and types of sulphur and phosphorus additives. Table 1 (right) lists the additives involved. If a certain component of the additive is crossed twice in a column of a test oil, this indicates that two different variants of additives, based on the identical ingredient, are contained. The comparison of the additivated oils with the respective base oil from Table 1 (left) allows to identify the influence of the additivation.

**Table 1.** Characterization of base oils (left) and additivated oils (right)

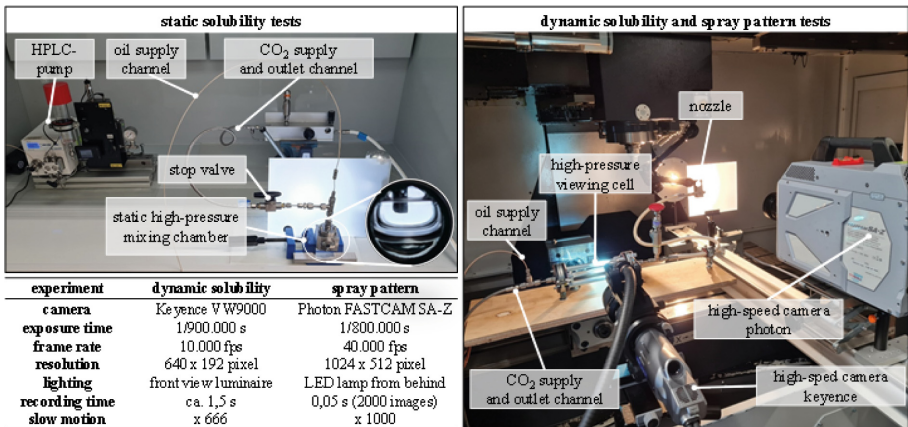
name	chemical structure	RRM content (Renewable Rawmaterial)	name	chemical structure	additives	
					sulphur	phosphor
KW 02	hydrocrackoil	0 %	KW 0201	hydrocrackoil	x	
KW 01	renewable	75 - 99 %	KW 0101	renewable	xx	x
NE 01		100 %	NE 0101		xx	x
NE 02	triglyceride	100 %	NE 0102		x	x
NE 03		100 %	NE 0103			x
SE 01		75 - 99 %	NE 0201		x	
SE 09	monoester	>50 %	NE 0202		x	x
SE 11	ester	unknown	NE 0203	triglyceride	x	x
SE: synthetic ester		KW: natural hydrocarbon	NE 0204		xx	x
NE: natural ester			NE 0205		xx	x
			NE 0206		xx	xx
			NE 0301		x	
			NE 0302		x	x
			SE 0101		x	x
			SE 0901	monoester	x	
			SE 0902		x	x
			SE 1101	ester	x	

#### 3.2 Solubility and Sprayability

With the aid of high-pressure view cells developed at the REP Institute, it is possible to investigate the solubility during a single-channel supply of the two media oil and CO<sub>2</sub> in static and dynamic state. For the visualization of dynamic miscibility and flow behavior,

the high-pressure view cell is used and investigated in a coupled experimental setup with the free jet nozzle for the investigation of the sprayability.

The static cell has a volume of  $V = 1$  ml. The sight glasses mounted on both sides allow observation and documentation of the solubility behavior within the cell. Figure 1 (left) shows the experimental setup, as well as a detailed view of the chamber. For the experiment, the cell is filled with  $V_{oil} = 0.2$  ml and the remaining volume consists of  $V_{LCO_2} = 0.7$  ml and an estimates gaseous fraction of  $V_{CO_2} = 0.1$  ml based on a filling line. A separation layer between liquid and gaseous  $CO_2$  confirms the existence of the two phases. To accelerate the dissolution process, the cell is shaken after filling for 10 s.



**Fig. 1.** Experimental setup static (left) and dynamic solubility and spray pattern test (right)

This combination of the dynamic solubility and the spray pattern test results in an increased significance of the test results, since the sprayability can be directly related to the flow behavior in the dynamic cell. Figure 1 (right) illustrates this test setup. Both subtests are documented with separate high-speed cameras. The parameters are summarized in Fig. 1. The nozzle outlet diameters are also varied ( $d_i = 0.2$  mm/0.3 mm).

## 4 Results

Finally, the results of the solubility and sprayability studies are described. After that, the results are correlated with tool life tests of a milling process.

### 4.1 Solubility and Sprayability

Complete solubility of the synthetic esters is observed in the static cell. Furthermore, a partial solubility of selected oils in  $LCO_2$  or no solubility of the two media in each other can be observed. Figure 2 (left) compares the three observed states. With the exception of SE 1101, all synthetic esters dissolve completely in  $LCO_2$ . The additivation of the base oils does not seem to exert any direct influence with regard to solubility. The

corresponding base oil is always placed in the identical category as the additivated configurations. The results from the test series with the dynamic cell are characterized by a specific phenomenon: for the test oils based on rapeseed and sunflower oil, a slower laminar boundary flow of oil was observed when the test was carried out with the nozzle  $d_i = 0.2$  mm. The boundary flow has a sawtooth shape and the tips are carried along impulsively by the passing main-flow. The additivation has no effect on this, since it occurred with identical intensity when using the related base oil. It can be stated that the test oils with the highest dynamic viscosity are also involved in this phenomenon.

During the tests with the nozzle  $d_i = 0.3$  mm, no boundary flow was observed with the lubricants concerned. Thus, it appears that not only the viscosity determines a boundary edge flow but also the flow velocity. The velocity can be increased from approx.  $v = 1$  m/s to approx.  $v = 2.5$  m/s by changing the nozzle. Figure 2 (right) compares two exemplary flows for the test with the free jet nozzle  $d_i = 0.2$  mm.

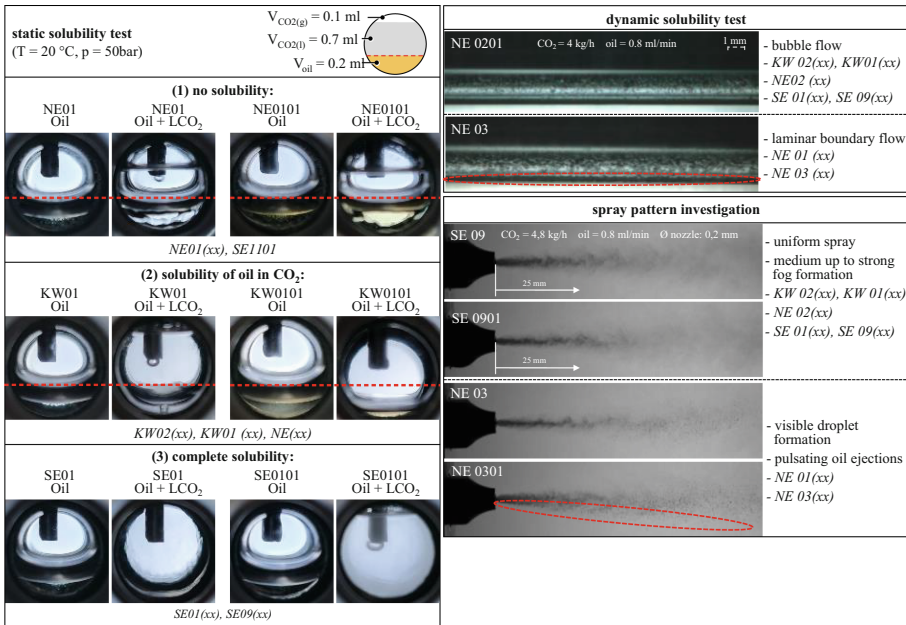


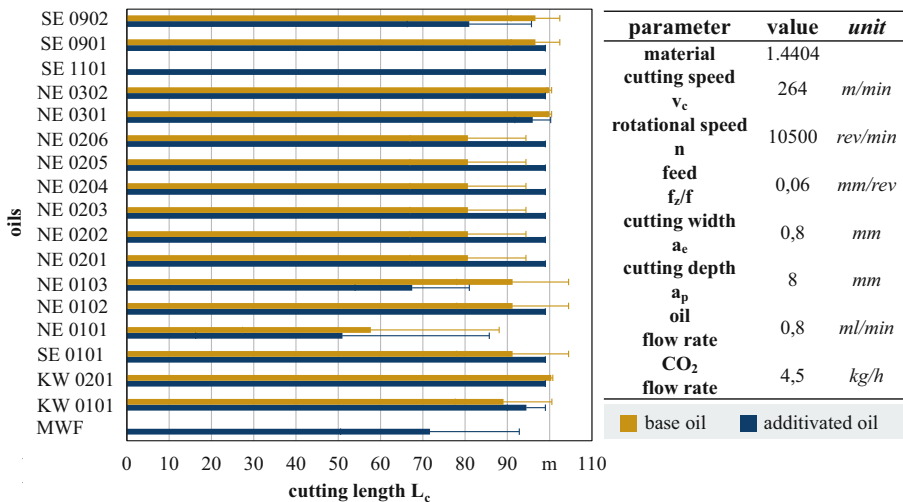
Fig. 2. Results of solubility and spray pattern investigation

The collected data can be used to classify the main jet length and the uniformity of the spray pattern for the various lubricants. Furthermore, the formation of mist behind the jet and large visible oil droplets can be used to draw conclusions about the atomization capability of a lubricant. A direct correlation between the previously discussed boundary flow in the dynamic cell and the large oil droplets falling sideways in the free jet can also be established. The oil drops, deposited at the boundary in the dynamic cell, do not mix sufficiently with the main-jet after impulsive entrainment by the main-jet up to the nozzle outlet and because of this the oil droplets fall off laterally after the nozzle outlet. Consequently, this phenomenon could not be observed in the free jet test with

nozzle with  $d_i = 0.3$  mm, since no boundary flow could be detected in the cell, it can be assumed that the flow velocity is a decisive factor for the formation of the laminar boundary flow. It repeatedly becomes clear that also with regard to the observations in the spray pattern test, no concrete influence of the additives can be determined.

## 4.2 Correlation with Milling Process

In general, it can be determined that the bio-based lubricants in combination with CMQL provide a better result than the reference test with emulsion (MWF) and flood cooling. Figure 3 shows the tool life diagram for a correlation of the lubricant tests with the machining series performed. For each additivated lubricant, the tool life achieved with the corresponding base oil is shown in yellow.



**Fig. 3.** Cutting length for CMQL Milling

The effectiveness and influence of the additives, on the other hand, cannot be clearly clarified for this process. For example, in the case of sunflower oil, a higher tool life could be achieved with the base oil (NE 03) than with the additivated configurations (NE 03(xx)). A correlation with the lubricant tests can also only be established to a limited extent. Exemplarily, the complete solubility of the synthetic esters in the static view cell does not seem to exert any direct influence on the effectiveness during machining. Thus, in the case of the synthetic esters, the polarity of the lubricant can also be discussed. This turns out to be slightly polar or polar for the lubricants treated in this study. Accordingly, a better solubility of non-polar lubricants in LCO<sub>2</sub> cannot be confirmed. With regard to machining, the solubility of the lubricant used in CO<sub>2</sub> generally does not appear to have any effect on the performance of the machining process.

## 5 Summary

Hydrocarbons (KW 01(xx), KW 02(xx)) partially dissolved in CO<sub>2</sub>. With the help of additives, the result could be improved for milling with external cooling. Natural esters based on rapeseed oil (NE 01(xx)) and sunflower oil (NE 03(xx)) provide an intensive oil application and, at low flow rates, exhibit a boundary flow of oil deposited at the edge in the dynamic cell. In contrast, lubricants from the less viscous coconut oil (NE 02(xx)) atomize very intensively. The investigated synthetic esters (SE 01(xx), SE 09(xx)) atomize just as intensively and also exhibit complete solubility in the static cell. A direct influence of the results of the spray and miscibility tests on the machining could not be determined. However, when using CMQL and especially when using bio-based lubricants, the selected process and cooling lubrication parameters have a significant influence on tool life in machining [15].

**Acknowledgments.** The results are part of the research project "Development of bio-based metalworking oils for cryogenic minimum quantity lubrication". Thanks go to the German Agency for Renewable Resources and the German Federal Ministry of Food and Agriculture for funding the joint project. The consortium consists of REP-Chair FAU Erlangen-Nuremberg, Gühring, EagleBurgmann, Schaeffler, Fuchs, Rhenus and Blaser.

## References

1. Fachagentur Nachwachsende Rohstoffe e.V. Bioschmierstoff-Kongress, Gülzow (2015)
2. Redetzky, M.: Wirkmechanismen, Eigenschaften und Leistungsfähigkeit mikrobiell basierter Kühlschmierstoffe in der spanenden Fertigung. Dissertation (2017)
3. Mang, T. (Hrsg.), et al.: Lubricants and Lubrication. Wiley-VCH Verlag, Weinheim (2017)
4. Pirro, D.M. (Hrsg.), et al.: Lubrication Fundamentals. Boca Raton, London, New York (2016)
5. Torbacke, M. (Hrsg.), et al.: Lubricants: Introduction to Properties and Performance (2014)
6. Kassack, J.F.K.: Einfluß von Kühlschmierstoff-Additiven auf Werkzeugverschleiß Zerspankraft und Bauteilqualität (1994)
7. Srivastava, S.P. (ed.): Wiley, Hoboken, NJ (2014)
8. Czeslik, C., et al.: Basiswissen Physikalische Chemie, Wiesbaden (2010)
9. Fahl, J.: Entwicklung und Erprobung von Schmierölen für Kälte- und Klimasysteme mit CO<sub>2</sub> als Arbeitsstoff. Ruhr-Universität Bochum, Fakultät für Maschinenbau (2002)
10. Grguras D., et al.: Media flow analysis of single-channel pre-mixed liquid Co<sub>2</sub> and MQL in sustainable machining. *J. Mech. Eng.* **67**, 1–2 (2021)
11. Meier, T., et al.: Comparison of sprayability and solubility of bio-based lubricants with liquid carbon dioxide. *MM Sci. J.* (2021)
12. Pursell, M.: Experimental investigation of high pressure liquid CO<sub>2</sub> release behavior Health and Safety Laboratory. In: Symposium Series, no. 158 (2012)
13. Gross, D., Blauhöfer, M., Hanenkamp, N.: Milling of Ti6Al4V with carbon dioxide as carrier medium for minimum quantity lubrication with different oils. *Procedia Manufacturing* **43**, 439–446 (2020). <https://doi.org/10.1016/j.promfg.2020.02.190>
14. Meier, T., Gross, D., Hanenkamp, N.: Investigation of lubricating oils from renewable resources for cryogenic minimum quantity lubrication. *MM Sci. J.* **2021**(5), 5069–5076 (2021). [https://doi.org/10.17973/MMSJ.2021\\_11\\_2021154](https://doi.org/10.17973/MMSJ.2021_11_2021154)

15. Meier, T., Seydaack, M., Gross, D., Hanenkamp, N.: Investigation of the influence of the additivation of a biological metalworking oil in cryogenic machining. *Procedia CIRP* **105**, 694–699 (2022). <https://doi.org/10.1016/j.procir.2022.02.116>
16. Hanenkamp, N., Amon, S., Gross, D.: Hybrid Supply system for conventional and CO<sub>2</sub>/MQL-based cryogenic cooling. *Procedia CIRP* **77**, 219–222 (2018). <https://doi.org/10.1016/j.procir.2018.08.293>

**Open Access** This chapter is licensed under the terms of the Creative Commons Attribution 4.0 International License (<http://creativecommons.org/licenses/by/4.0/>), which permits use, sharing, adaptation, distribution and reproduction in any medium or format, as long as you give appropriate credit to the original author(s) and the source, provide a link to the Creative Commons license and indicate if changes were made.

The images or other third party material in this chapter are included in the chapter's Creative Commons license, unless indicated otherwise in a credit line to the material. If material is not included in the chapter's Creative Commons license and your intended use is not permitted by statutory regulation or exceeds the permitted use, you will need to obtain permission directly from the copyright holder.





# Potential of Radar Based Measuring Systems in Hot Forging

M. Bergmann<sup>1</sup> (✉), M. Dix<sup>1</sup>, T. Wallbaum<sup>2</sup>, and R. Selbmann<sup>1</sup>

<sup>1</sup> Fraunhofer Institute for Machine Tools and Forming Technology, Reichenhainer Straße 88,  
09126 Chemnitz, Germany

markus.bergmann@iwu.fraunhofer.de

<sup>2</sup> Institute for Machine Tools and Production Processes, Chemnitz University of Technology,  
09126 Chemnitz, Germany

**Abstract.** Hot forging processes and process chains provide components, which meet highest demands due to mechanical properties. A wide range of applications in different industries like oil and gas, automotive and aviation are based on such processes. As those processes are very productive unfavorable process conditions and unnecessary reject or rework are a strong issues and still not solved for industrial scale production. One key challenge is to generate geometrical information of the workpiece. The geometrical characterization of hot forged parts is usually carried out in cold condition resulting in an extensive time delay to processing. Information about the part geometry during processing and right after processing – in hot condition -- is not accessible. An approach to address this are radar based measuring systems. Those systems have specific characteristics like sufficient accuracy and robustness which qualifies them for measuring tasks under rough conditions typically occurring during forging processes. In the paper, different use cases for the application of radar-based measuring systems are identified and analyses based on laboratory scale experiments.

**Keywords:** Radar based measuring system · Hot forging · Measuring under rough conditions

## 1 Introduction

This paper presents a systematic analysis of the potential using radar based sensors respectively systems to acquire geometric work piece data in hot forging processes. These processes should be more sustainable designed in the future. The focus criterion there is resource efficiency. Valid data is the basic requirement to optimize processes. Integrated data based optimization has the potential to: a) increase in material efficiency - detection of trends and quality defects; b) increase in efficiency and objectivity in heat measurement c) tighten tolerance of process windows and dimensions d) reduce of raw material mass and temperature e) increase transparency through data collection.

In hot forging, components with a high level of geometric complexity and highest demands on mechanical properties are produced. Forged parts are usually measured

after processing in room temperature. Hence, defect parts are identified after complete manufacturing only. Up to recognizing an error in the process, for example systematic ones (die shift, tool wear, etc.), large quantities of rejects are produced and unnecessary additional costs caused. A high potential for industrial relevant component recognition and error detection is the application of radar-based sensor systems. The sensors are characterized by thermal robustness and are able to record the geometry - over time - even in the high-temperature range. These data can be enriched e.g. with temperature information of the forgings.

Various solutions are available for detecting products in manufacturing processes. Depending on the application and the required accuracy, inductive proximity sensors, mechanical tactile solutions, laser-based or optical systems are used. In the forging industry, these solutions usually could not be used effectively due to the requirements and boundary conditions such as cycle times, thermal radiation and possible contamination of the room air with dust and vapors. Other systems focus on measuring the component after forming. Therefore, a hot measuring cell demonstrator based on laser technology is suitable. In principle, the use of laser sensor systems is established for the geometric characterization of warm components. There is a need for encapsulation of the sensors and shielding of the component environment from external influences. Contamination of the optics by dust e.g. However, dust and water vapor, for example, are also unfavorable for the laser-based measuring systems. In addition, the costs of these systems are relatively high.

Radar based technology has been significantly simplified. As a result, radar technology could expand into non-military areas. Radar sensors are increasingly being used for industrial purposes. Distance sensors based on the frequency-modeled continuous wave method (FMCW) are used for production monitoring and quality control [1]. Recent developments show that radar-based sensor systems are suitable for thickness and width measurement when used in rolling mills. Therefore integrated, housed sensors like shown in Fig. 1 are developed. This sensor is based on a SiGe radar chip (SiGe = silicon-germanium). The core component of the radar sensor is the circuit board. A shielding body and a dielectric lens are attached to this circuit carrier. The Data interface is Ethernet based. The first pilot plants are operating with reliable measurement results. Other trends are MIMO radar systems (Multiple-Input Multiple-Output) for imaging radar applications as well as imaging radar with rotating sensors, e.g. SAMMI 2.0/3.0 [2].

## 2 Procedure and Methods

As the goal of the performed work is to identify and verify the potential of radar based measuring systems the following steps are prepared and presented: 1. Identification of relevant use cases in industrial scale (for forgings and preforms); 2. Derivation of scenarios which represent the use cases; 3. Design and setting up of measurement setups; 4. Testing and analysis. A systematical screening of possible applications carried out at different representative process chains is the basis for the application scenarios. As representative processes respectively process chains are the forging processes of gears, of driveshaft flanges, of rings, and of free forged components. The measuring could be performed before, during and after processing. In a next step the identified use cases



are clustered and due to similarity of the measuring task summarized into four different scenarios. Table 1 shows the identified scenarios.

**Table 1.** Use Cases and scenarios

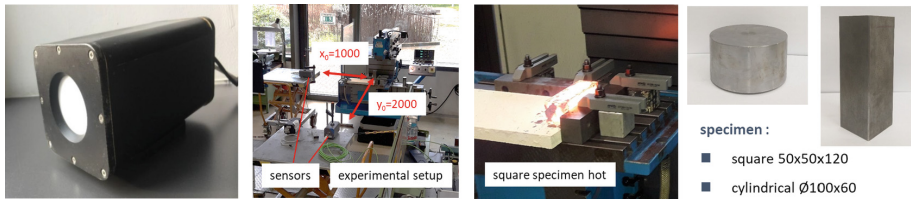
Szenario1 >>Position<<	Szenario 2 >>Distance<<	Szenario 3 >>Lines<<	Szenario 4 >>Surface<<
Position of component	Thickness measuring	Measure radii	Underfil
Position of tool (offset)	Spigot length detection	Web contour	Wear
	Characterize surfaces/openings	Diameter of components	Tool offset (part based)

Scenario 1 >>Position<< is designed to investigate and detect a position of a hot semifinished on the tool and the tool position as well. Those use cases address the verification of specimen positioning especially in hand-guided processes, setup processes and tool monitoring. Scenario 2 >>Distance<< relates to measuring of thickness of distinct spots respectively areas, the aspect of spigot length and the aspect of surface and opening detection. Scenario 3 >>Lines<< is based on movement of the sensor relatively to the specimen. It addresses the aspect of radii, the web contour and the diameter detection of components. Scenario 4 >>Surface<< is designed to detect underfil, wear and tool offset by reconstructing a full body of the forged component. For the laboratory analysis scenario 1 to 3 are selected as scenario 4 is at the time not adequately realizable. For the experimental analysis sensors which are successfully applied in hot rolling applications (hot sheet rolling) have been selected. The selected sensor are MS 122-1 FMCW radar from Mecorad like shown in Fig. 1 (left).

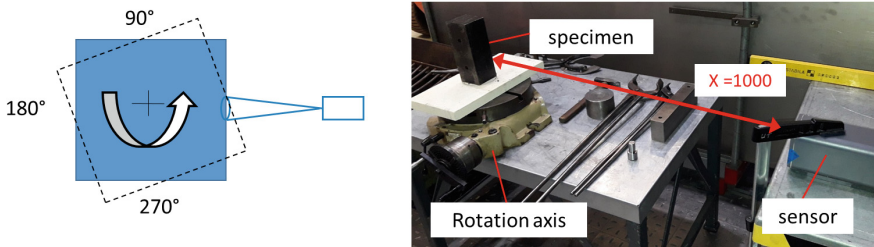
The experimental setup used for the investigation of scenario 1 and 2 is depicted in Fig. 1. The main components are two sensors, an NC-milling machine (used for positioning) and an oven. The setup is designed to move the sample in x and y direction. Positioning is determined by the machine control. The calibration of the setup is performed with a distance of app. 1000 mm in x-direction and 2000 mm in y-direction. The change of position is realized in three different increments, in separate series of measurement. Used increments are: 1 mm, 0.2 mm and 0.5 mm.

Figure 1, right shows the two used specimen and the placement of the specimen on the machine table in hot condition. For thermal decoupling an insulating panel is used for initial positioning mounting fixtures are implemented. In hot condition the specimen are heated up for 20 min at 1150 °C oven temperature. The surface temperature of the specimen is measured using a pyrometer. A temperature compensation is performed by cooling curves which are generated with the measuring setup. Therefore the specimen are heated up and measured during the cooling on air.

As the basic setup shown in Fig. 1 is used for the scenarios >>Position<< and >>Distance<< the compensation curves are used for the evaluation of both scenarios. The >>Distance<< scenario is carried out using exclusively the x-direction sensor. The distance between the sensor and the specimen is app. 1000 mm.



**Fig. 1.** Sensor, experimental setup of scenario 1 and 2; hot specimen on table, specimen



**Fig. 2.** Specimen and placement in hot and cold condition

The third investigated scenario is the >>Lines<< scenario. The experimental setup is designed and set up to investigate a rotating specimen linewise. Figure 5 shows the laboratory setup. The key components are rotation axis and a radar-sensor in a distance of app. 1000 mm to the specimen. The experiments are performed with the specimen shown in Fig. 5 as well. The sample is rotated around its own axis in 30-degree increments using a rotating device (see Fig. 2). The rotation started with the value 0°, then the test specimen was rotated in the said 30-degree steps up to 360°. The end position of 360° in turn corresponds to the start position of 0°.

### 3 Results

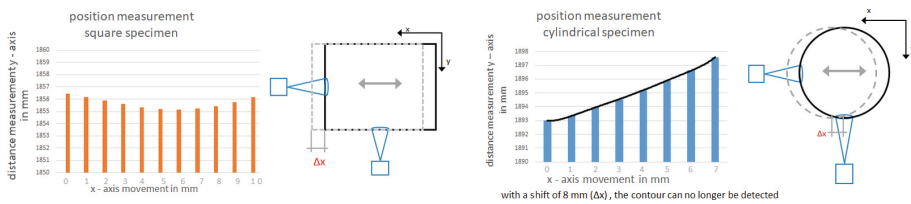
The following chapters show the results of the experimental measurements of the selected scenarios: >>Position<<; >>Distance<< and >>Line<<.

#### 3.1 Scenario 1 >>Position<<

Figure 6 shows the distance measurement in the Y direction using a sensor as a function of the displacement of the NC axis in the X direction. There was no displacement of the cuboid in the Y direction. The test evaluation of the position measurement of the side surface of the cuboid shows that this shows significantly higher deviations compared to the distance measurement. The initial value with a displacement of 0 mm represents the maximum value with a distance measurement of 1856.43 mm. The smallest value was detected with a displacement of 6 mm in the x-direction. Here the value of the distance is 1855.14 mm. Within the position measurement, the deviations are in a range of 1.284 mm. This is significantly higher than with the distance measurement. This large

systematic measurement error can be explained by the fact that the measurement spot of the radar is too large and thus echo signals were sometimes also recorded outside the measurement body in the event of a shift.

Analogous to the previous measurement, the position measurement of the cylinder lateral surface is shown in Fig. 7. It can be seen that the distance measurement value increases as the NC axis displacement increases due to the curved surface. It should also be mentioned here that a previous calibration took place before the measurement, so that the sensor detected the peak of the diameter contour with a displacement of 0 mm. It can be seen that the deviation increases as the displacement increases. One reason for this strong deviation could again be that the measuring spot was too large. This makes it possible for distance values to be recorded that are located next to the actual ideal measuring point. In addition, it should be noted that the sensor is only able to record a plausible echo signal from the lateral surface of the cylinder up to a displacement of 7 mm.

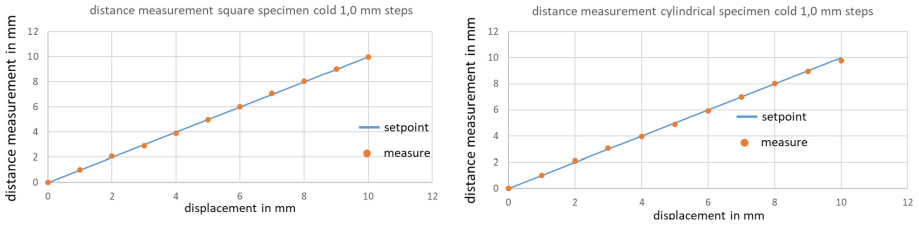


**Fig. 3.** Scenario >>Position<< Evaluation square specimen (left); round specimen (right)

From the test evaluation for the position measurement, it is deduced that the measurement of the straight as well as the curved surface is subject to a significantly higher systematic error. On one hand, this could be due to the measurement of a smaller area in the cuboid measurement, so that the measurement spot was also outside the measured area. In addition, the measurement of the curved surface shows that no echo signal is detected even with a slight inclination of the sensor axis to the test object.

### 3.2 Scenario 2 >>Distance<<

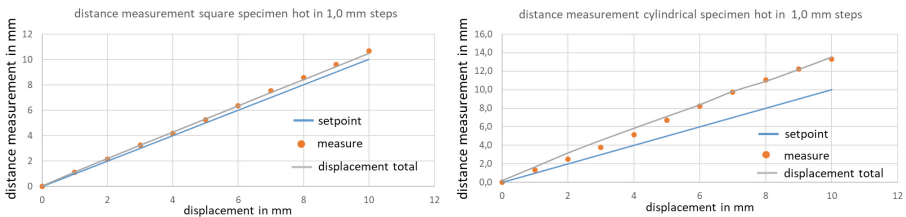
The results of the series of measurements to determine the measurement error of the radar sensor on a flat surface when cold can be seen in Fig. 4. The individual measurements of the respective increments of the position change of 1 mm are shown here. The blue line stands for the nominal value of the measurements, which corresponds to the displacement of the NC axis in the X direction. The orange dots mark the measured actual value of the displacement of the radar sensor. Here, the actual value refers to the difference between the measured distance and the measured initial value in the starting position of the tool slide. The individual measured actual values shown are again mean values, which were calculated from a set of  $n = 500$ . This means that distance measurements were carried out by the radar sensor 500 in a short time for each displacement position of the tool carriage. The results showed the largest absolute deviations in the positive and negative direction of 0.079 mm and  $-0.105$  mm with a step size of 1 mm.



**Fig. 4.** Scenario >>Distance<< - measurement square specimen cold, measurement cylindrical specimen cold

To provide the results of the cylinder lateral surface, the results are transferred to a coordinate system analogous to the other distance measurements (Fig. 3). The blue line marks the target value of the measurement and the orange dots indicate the mean value of the displacement measurement of the radar sensor in the respective position. The largest deviation between the target and actual value in the positive range is at a value of 0.149 mm. The largest deviation in the negative range has the value of  $-0.218$  mm.

As addressed in Sect. 3, when determining the displacement, the shrinkage of the cuboid and cylinder in the warm state must be taken into account. For this a shrinkage functions are derived. Based on the determined shrinkage functions and the determined temperature of the specimen, the respective influence of the shrinkage on the displacement can now be determined. Adding the displacement of the axis results in the total displacement, which corresponds to the nominal dimension. This target value is used in the same way as the measurement in the cold state in order to detect the deviations in the sensor measurement. Figure 5 (left) shows the individual results for measuring the side surface of the cuboid in the warm state. As before, the axis shift identity is labeled in blue and the readings in orange. In addition, the grey line characterizes the overall shift. With regard to the absolute deviations, it can be seen that these differ from the respective measurements and in the series of measurements with axis displacement in 1 mm increments, the target and actual values are a maximum of 0.196 mm apart.



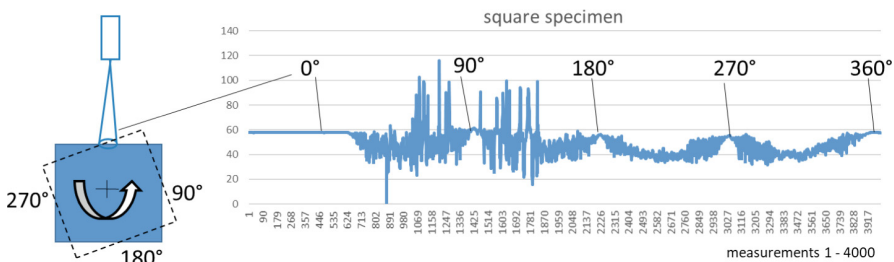
**Fig. 5.** Scenario >>Distance<< - measurement hot square (left), hot cylindrical (right)

In addition, the investigations into the measurement of the cylinder lateral surface in the warm state were evaluated using the same approach as described for the cuboid. The results are compared in Fig. 5. A similar pattern emerges here. The deviation is the smallest in increments of 1 mm, the maximum deviation here is  $-0.74$  mm. In general, it can be stated that the deviations on the cylinder are significantly larger. A plausible

reason for the higher values could be a larger error in the cylinder's contraction function. This evaluation shows that, under the given conditions, the FMCW radar sensor used can measure the straight surface with an accuracy of approx.  $\pm 0.1$  mm and the curved surface with an accuracy of approx.  $\pm 0.2$  mm when cold. This applies to all increments. For the measurement of the cuboid and the cylinder in the warm state, the accuracy of the measurement of the straight surface is approx.  $\pm 0.2$  mm and the curved surface is approx.  $\pm 0.5$  mm. Based on these results, it can be deduced that the FMCW radar sensor can detect distances to straight surfaces with higher accuracy compared to curved surfaces. This applies to the cold and warm state of the test specimen.

### 3.3 Evaluation Line Measurement

A preliminary test with square specimen was carried out to measure the lines of the side surface. A preliminary test was carried out to measure the lines of the side surface. For this purpose, the cuboid was positioned on the rotation device and then rotated around its axis while constantly recording the distance. From this preliminary test it can be deduced that the distance measurement can only measure the distances of a straight surface for small angles of rotation. As can be seen from Fig. 6, measuring a sloping surface facing the sensor, there are strong fluctuations in the measured values recorded by the radar sensor. In the positions  $0^\circ$ ,  $90^\circ$ ,  $180^\circ$ ,  $270^\circ$  and  $360^\circ$ , the surface is perpendicular to the sensor. This shows that the individual fluctuations decrease significantly.



**Fig. 6.** Scenario >>Line<< - measurement square specimen

Based on the findings that could be gained from the preliminary test, it was now determined how far the side surface of the cuboid can be twisted. The increment was one degree. The rotation takes place first in the mathematically positive and then in the negative direction of rotation. The steps were carried out until the sensor could no longer record the side faces of the cuboid with sufficient accuracy.

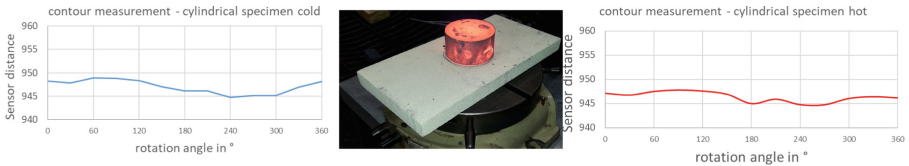
Figure 7 shows the results of the line measurement in the cold and warm state in a rotation angle range of  $-7^\circ$  to  $7^\circ$ . There is a clear tendency here that the measurements become more and more imprecise with increasing tilting. The absolute values tend to deviate strongly from the actual value, which can be determined at  $0^\circ$ . With increasing rotation angle, after evaluating the data it can also be stated that with increasing tilting (related to the radar device), the standard deviations of the measurements increase significantly in relation to the mean value of the respective individual measurements. It can be



**Fig. 7.** Scenario >>Line<< - measurement of a square surface, varying angle of inclination

derived that the measurement accuracy of the radar sensor with regard to the systematic deviation and random deviation increases significantly when a straight surface, such as the side surface of the test body used, is tilted.

In the case of the cylindrical surface, the cylinder was rotated around its own axis in 30-degree increments both in the cold and in the warm state using a rotary device. The rotation started with the value  $0^\circ$ , then the test specimen was rotated in the said 30-degree steps up to  $360^\circ$ . The end position of  $360^\circ$  in turn corresponds to the start position of  $0^\circ$ .



**Fig. 8.** Scenario >>Line<< - measurement cylindrical specimen

Figure 8 shows the mean values of the distance measurement between the sensor and the component in the cold and warm state in the respective position. The evaluation shows that after the eccentricity has been deducted, the diameter values oscillate in a range between 2.20 mm for the cold measurement and 2.14 mm for the warm measurement. Thus, under the present measurement conditions, the line measurement can be carried out equally well in the cold as well as in the warm state.

## 4 Discussion and Conclusion

Achieving clear reflection of the radar signal and a examinable signal is crucial for a proper measuring using radar based systems. Surfaces that are planar to the sensor can be reconstructed well. The parallel displacement to the sensor can be detected with high resolution for both flat and cylindrical surfaces.

The adaptation of the measuring systems for position monitoring and thickness, width, length measurement appears possible with adaptation measures. The measurement of round material is technically less demanding than billet material. When measuring contours, it has been shown that the inclination of flat surfaces to the sensor already leads to major errors from an angle of  $\pm 2^\circ$ . Inclined surfaces lead to low backscatter. Here, in-depth analyzes and changes to the evaluation algorithms of the echo signal become necessary. The detection of the contours of cylindrical geometries could already

be realized quite well. The exact alignment of the sensor to the axis of rotation must be taken into account here, since, as the position detection has also shown, a displacement of the central axis by 8% in relation to the cylinder diameter leads to incorrect signals. Possible solutions are seen here in the trajectory (sensor movement) and further investigations into signal processing steps for better results.

In principle, radar-based measurement technology appears to be suitable for forging applications. Applications are foreseeable, in particular for position detection, distance measurement and diameter measurement.

## References

1. Fritsche, P.: Umgebungsmodellierung Mit Radarsensoren und Gestörten Sichtbedingungen. Gottfried Wilhelm Leibniz Universität, Diss, Hannover (2019)
2. Nüßler, D., Jonuscheit, J.: Terahertz based non-destructive testing (NDT). Technisches Messen (2020)


**Open Access** This chapter is licensed under the terms of the Creative Commons Attribution 4.0 International License (<http://creativecommons.org/licenses/by/4.0/>), which permits use, sharing, adaptation, distribution and reproduction in any medium or format, as long as you give appropriate credit to the original author(s) and the source, provide a link to the Creative Commons license and indicate if changes were made.

The images or other third party material in this chapter are included in the chapter's Creative Commons license, unless indicated otherwise in a credit line to the material. If material is not included in the chapter's Creative Commons license and your intended use is not permitted by statutory regulation or exceeds the permitted use, you will need to obtain permission directly from the copyright holder.





# Evaluation of Thermal Error Compensation Strategies Regarding Their Influence on Accuracy and Energy Efficiency of Machine Tools

Christian Naumann<sup>1</sup> (✉) , Axel Fickert<sup>2</sup>, Lars Penter<sup>1,2</sup>, Carola Gißke<sup>3</sup>, Eric Wenkler<sup>1,2</sup>, Janine Glänzel<sup>1</sup>, Philipp Klimant<sup>1,4</sup>, and Martin Dix<sup>1,4</sup>

<sup>1</sup> Fraunhofer IWU Chemnitz, Reichenhainer Str. 88, 09126 Chemnitz, Germany

Christian.Naumann@iwu.fraunhofer.de

<sup>2</sup> Technical University Dresden – IWM, Helmholtzstr. 7a, 01062 Dresden, Germany

<sup>3</sup> Technical University Dresden – Digital Health, Münchner Platz 3, 01087 Dresden, Germany

<sup>4</sup> Chemnitz University of Technology – IWP, Reichenhainer Str. 70, 09126 Chemnitz, Germany

**Abstract.** Friction, electrical losses, cooling systems and ambient conditions influence the thermal field of machine tools and cause a significant amount of positioning inaccuracies and production errors. Compensation strategies aim to reduce the thermal error in machine tools. The global urgency for energy-efficient production also affects the selection of specific compensation strategies, especially since some of them consume significant amounts of energy while others are potential energy savers. As of today, there is no method to select the optimal compensation strategy for thermal errors in machine tools. The main reasons are that the quality of any compensation strategy depends heavily on the examined machine tool and its intended usage. Besides this, there are several, often conflicting assessment criteria.

This paper provides an overview of existing compensation strategies and presents an evaluation of their effect on the energy consumption. The investigated strategies comprise methods for reducing the heat losses, for decreasing the sensitivity of the tool center point to thermal influences, cooling strategies for removing heat from the machine tool, air conditioning and methods for controllable heat transfer and also various computational methods aimed at predicting and correcting the existing thermal positioning error in the machine tool control.

As an addition to previous research, the rating of thermal error compensation strategies was extended by their effect on energy efficiency. The authors demonstrate that accuracy and energy efficiency must be considered jointly for each individual machine tool and manufacturing task.

**Keywords:** Machine Tool · Thermal Error · Error Compensation · Energy Consumption · Efficiency · Effectiveness

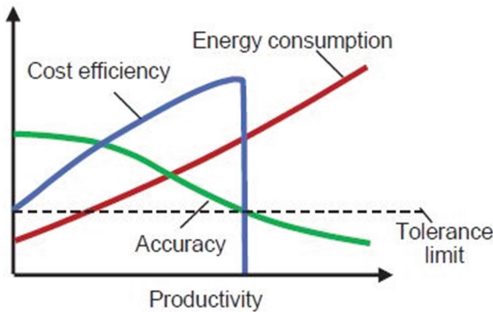
## 1 Introduction and Motivation

Machine tools are one of the central pillars of manufacturing, constituting about 70% of the total operating machines in the industry [1]. The industry has had a share of



about 45% of the global electrical energy demand in 2020. The electricity demand of the industry has risen by about 30% between 2010 and 2020 and a further rise of another 35% by 2030 is projected, surpassing even the demand of the buildings sector [2]. While an increasing amount of energy supply is generated by renewable energy sources, total electricity generation is expected to continue to increase and along with it, CO<sub>2</sub> emissions will continue to rise [3]. Reducing the energy demand in machine tools can therefore be a meaningful path to lowering the global electrical energy demand and have a positive environmental impact.

Reducing the power consumption of machine tools also reduces their operating costs and thereby gives them competitive advantages over conventional, inefficient machine tools. Operating costs are, however, only one criterion in the evaluation of machine tools. According to Schischke, machine tool users prioritize productivity, quality, accuracy, availability, service and price in the selection of machine tools with energy consumption being the least important criterion [4]. While increasing energy costs will likely make energy consumption more important in the future, energy reduction measures can only be successful in industrial applications if they do not come at significant expense of the former factors. This conflict is exacerbated by the fact that industrial applications increasingly require smaller lot sizes, a larger number of product variants and higher accuracy [5].



**Fig. 1.** Conflict between energy consumption, productivity and accuracy in machine tools

machine tools [7] and is thus significantly larger than geometric, static and dynamic errors. Moreover, the study revealed that even among the machine tool operators, the thermal error was believed to be almost as large as the other error components combined, showing that much of the thermal error is not being fully dealt with by the machine tool systems. Additionally, a significant portion of the thermal error stems from the tool and the workpiece [7].

Increasing productivity for a single cutting operation means higher feed rates and faster movements. (Above a machine-specific threshold,) this leads to larger dynamic errors and through higher waste heat also to larger thermal errors. The thermal waste heat comes mainly from friction, electric losses, hydraulic and pneumatic systems. The

Grossmann et al. have illustrated this conflict in Fig. 1 [6]. Though this chart is vastly oversimplified, it is generally true that high productivity makes it more difficult to maintain accuracy and increases the (operational) energy demand. The most significant influence on the accuracy is the thermal error. An industrial survey by Regel et al. among 75 machine tool manufacturers and users has determined that the thermal error makes up almost two thirds of the total positioning error of

use of cooling systems and air-conditioning can remove some of the waste heat from the machine tool and thereby stabilize its temperature field and reduce the thermal errors at the expense of additional electrical energy.

To summarize this, higher productivity requires more energy to both run and stabilize the manufacturing process. This oversimplified view, that one cannot have high productivity without a large energy consumption is likely the main reason why productivity is first and energy demand is last among the criteria for the selection of machine tools [4]. The reality is far more complex, however. On the one hand, higher productivity actually typically decreases the overall energy consumption. On the other hand, the thermal error can be managed through a large number of compensation strategies, many of which have only negligible effects on the energy demand. Thus, this paper aims to show how high productivity and high accuracy can be achieved by energy-efficient production systems. This will be done by reviewing and evaluating both energy-efficiency measures and thermal error compensation strategies and by explaining their possible interactions and combined uses.

Section 2 will list some ways to improve the energy-efficiency of machine tools and explain their effect on the thermal error. Section 3 gives methods for reducing the thermal error in machine tools and their effect on the energy demand. Finally, a conclusion and outlook on future research topics will be given in Sect. 4.

## 2 Energy-Efficient Manufacturing Technology

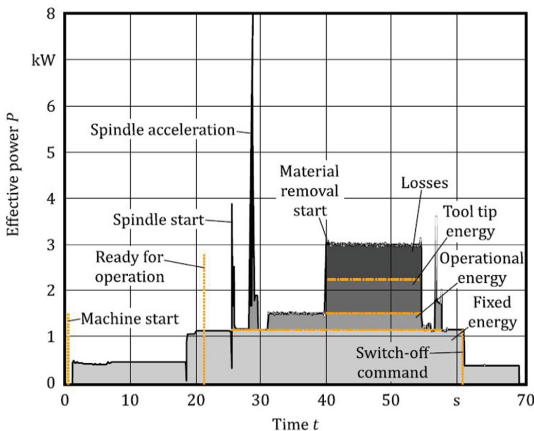


Fig. 2. Power profile of a turning process [8]

interface, evacuation and air conditioning. Thus, the most effective means of reducing the energy demand of machine tools is to increase the productivity during cutting operations to reduce the operating time and to shut off as many systems as possible during the non-productive phases.

There are a number of ways to reduce the machine tool operating time:

- Increase the feed rate and/or depth of cutting,

Figure 2 shows an example of a turning process [8] and demonstrates why most of the energy demand of machine tools is fixed, not directly correlated to the process related energy consumption. This energy is used for various support units such as the hydraulics (e.g. for cooling and lubrication, clamping or hydrostatic guides), compressed air (e.g. for bearings, pneumatics and sealing applications), chip removal, oil mist extraction, fluid preparation, machine control, human machine

- Reduce air cutting motions (i.e. optimize CAM strategies),
- Parallel processing (e.g. simultaneous NC operations, multi-spindle cutting, multiple workpieces in the workspace),
- Optimized machine tool manipulation (e.g. faster or automated loading, unloading and setup of workpieces).

Of these measures, all but the first one, actually improve the thermal behavior of the machine tool, as they generally lead to more stable temperature fields. While the increased productivity will lead to more waste heat and thus larger deformations, these are easier to deal with using cooling strategies or model based compensation methods. Increasing the feed rate or depth of cut can similarly be beneficial, but it may also increase static and dynamic errors, increase tool wear, increase the thermal error components of the tool and the workpiece and also increase scrap in general. Nevertheless, optimizing cutting parameters to maximize productivity is sensible and there are numerous methods of dealing with the aforementioned issues, e.g. predicting the thermal errors of tool and workpiece, predicting the static deflection and dynamic operating limits of the machine tool and even estimating the remaining useful tool life [9–12]. Energy optimization via improved cutting parameters was investigated and achieved, e.g., by Li et al. [13] and Han et al. [14].

Another means of improved energy efficiency is energy-optimal enterprise resource planning (ERP). This includes choosing the right machine tools for the individual cutting tasks and optimizing the order of these tasks to make the most of energy-saving shutdown cycles of machine tools [15, 16]. This approach requires some flexibility in as well as knowledge of machine tools, operators and schedules but has the potential to significantly reduce the manufacturing related energy consumption without any additional cost in resources or decrease in product quality.

One of the most important methods for reducing the energy consumption of machine tools is to use demand-oriented supply systems. In the case of the cooling system, this can, e.g. be realized by using clocked compressors instead of a bypass to shut down the compressor when the coolant temperature is acceptable [17]. This can be done in a way that maximizes the shutdown time without affecting the thermal stability of the machine tool. Another important option is to use minimal quantity lubrication (MQL) or even dry machining to reduce the energy demand for cooling and processing of the cutting fluids. However, especially dry milling significantly increases tool wear and MQL typically requires air compressors to supply the large pressures needed and can thus create even larger CO<sub>2</sub> emissions than flooded cooling (though overall MQL remains better environmentally) [18]. From a thermal point of view, flooded cooling is the most effective way to remove waste heat from the cutting process and thereby minimize the thermal errors of the machine tool, the tool and the workpiece. However, as previously stated, model based prediction algorithms can create good estimations of these deformations for MQL and dry milling and thereby eliminate most of these errors. Demand oriented bed flushing, evacuation and chip conveyor activation are likewise simple methods for improving the energy efficiency of machine tools. These measures can also affect the thermal behavior of the machine tool but their magnitude is limited and good model based compensation schemes must consider these effects in any case.

Last but not least is the energy-efficient design of machine tools and their components. This includes, e.g. using light-weight structures, using energy-efficient, demand-oriented supply systems, low-friction guides and bearings, regenerative braking, counterweights and thermo-energetic machine tool design. Using light-weight structures has a significant effect on both thermal as well as dynamic dampening, which is why they are usually rare or restricted to certain components. Additionally, they make FEM simulation based compensation algorithms significantly more difficult to model and parametrize. On the other hand, all measures that reduce friction or the energy demand for moving machine tool assemblies also reduce the waste heat influx and thereby improve both the thermal as well as the energetic behavior of the machine tool. Thermo-energetic design such as thermo-symmetry, passive cooling structures or reducing the effects of waste heat on the TCP position can also be energy-efficiency measures as they allow the reduction or down-sizing of cooling systems and may shorten or eliminate lead times after machine tool startup or after production breaks [19].

### 3 Thermal Error Compensation

Following the understanding of Großmann et al. [20] thermal error compensation can be distinguished into design based, measurement based and model based methods. Design based methods aim to change or reduce the heat flow in the machine tool so that temperature gradients and the resulting displacements are reduced. These methods include, e.g., various cooling and air conditioning strategies, light-weight structures, material property optimization, thermo-symmetric design and the use of efficient drives and supply systems.

Measurement and model based methods, aim to predict the thermally induced deviation at the TCP and eliminate it via offsets in the machine tool control. Both methods have minimal impact on the energy consumption of the machine tool. However, they have the potential to reduce the amount of cooling needed, thereby decreasing the energy consumption of the cooling system of the machine tool. This in turn can increase the overall energy efficiency of the machine tool. Most of these algorithms can be used in conjunction with the above mentioned design based methods as well as with many of the concepts listed in the previous chapter. It is, however, usually necessary to adjust these prediction algorithms to any method which significantly alters the thermal behavior of the machine tool. Algorithms based on FEM simulations or transfer functions must be expanded to include any additional heat sources and sinks and must be able to reproduce, e.g. load profiles for demand-oriented cooling strategies. Regression based algorithms may require altered load cases for model training as well. Interesting in this respect is the compensation using integrated deformation sensors, which has design based limitations in its usage but can generally handle almost all of the energy efficiency improvement measures without any adjustment or consideration [21].

In the following, two approaches will be presented that can support an energy efficient control of cooling systems. Since cooling systems account for a large part of the machine tool's energy consumption, efforts should be made to achieve demand-oriented cooling [22].

Wenkler et al. presented an approach to reduce thermal changes in the machine tool by grouping machining processes depending on their caused power losses [23]. Their

strategy is based on loss predictions for machining tasks, by analyzing the G-code of a process and predicting the machining-specific loss trajectories. These trajectories can then be arranged so that the loss jumps in the process transitions are minimal. On the one hand, the concentration of loss troughs and peaks directly reduces the thermal dynamics. On the other hand, the concentrated loss peaks can be cooled more efficiently, since the thermal gradient from machine tool to coolant is greater and there are also larger areas in which the cooling system can be switched off or its power consumption can be reduced. Their experimental results reveal a potential reduction of about 10% in thermal changes concerning the segmentation approach. The strategy is currently partially automated but could be fully automated for an industrial application in the future.

A second approach is presented by Shabi et al. [24] aimed at optimizing the cooling strategies. The investigation of two demonstrator machines has shown that the energy consumption of the cooling and lubrication systems on the DBF630 machining center amounts to 44% and on the DMU80 eVo machining center to 45% of the total energy consumption of the machine tools [25]. Thus, there is a great potential for reducing the energy consumption and increasing the efficiency of the machine tools by optimizing the operation of the fluid power systems. Because of the rather inefficient activation procedures of conventional cooling systems, the temporal concentration of cooling relevant areas can lead to a decrease in the activation number and therefore increase the overall efficiency of the cooling system while maintaining thermal stability. To use this potential, optimized fluid power system structures were developed by Shabi in 2020 [26]. Test results of the cooling system on the demonstrator DBF630 in the production process have proven that sufficient cooling capacity is available. Simulation results of the developed cooling system structures have shown that a stable temperature field can be achieved compared with the initial state. In addition, the flow supply leads to an improvement in the hydraulic performance of the pumps. The energy consumption of the pumps used with the new structures, is about 53–70.5% lower than that of the current cooling structures.

## 4 Conclusion and Outlook

The reduction of the energy demand in manufacturing can significantly impact man-made CO<sub>2</sub> emissions and thus aid in the struggle against global warming. One major contributor to production related energy consumption are machine tools, which can be viewed as the workhorse of the industry. Currently many machine tool users value productivity, accuracy and price over the energy-efficiency. There are, however, numerous ways to satisfy these key criteria while employing energy-efficient machine tool designs.

Thus far, many options for lowering the energy demand of machine tools have been suggested as well as methods to help them in dealing with thermal issues. The question of what measures specifically need to be taken to achieve energy-optimal, accurate manufacturing, remains unanswered. This is mainly because the application (workpiece, machining technology, ...) and the circumstances (new design vs. existing machine, factory conditions, ...) determine the most suitable strategies.

For existing machine tools, barring the option of a major retrofit, design alterations are not possible. Therefore, the best way to save energy will be to optimize the usage of

all available machine tools by selecting the best one for each job and keeping them shut off as much as possible. At the same time, the productivity should be maximized with high feed rates and optimized CAM paths while also employing demand-oriented supply systems to the extent that the existing hardware allows. This will definitively impact the thermal error, so that model based compensation algorithms should be employed to maintain the required accuracy. All of these solutions are purely software based and require at most additional sensors (e.g. temperature sensors).

For new machines, the full suite of measures is available and it is important to keep in mind, that changing thermal properties may impact the mechanical properties (especially dynamic behavior) and that the machine tool should be considered together with its factory and the intended process chains. In this context, the Internet of Things has much to offer, so that hardware and software interfaces are also important. Energy-efficient designs and energy-optimal components should be part of all new machine tool designs as far as they are affordable. The design choices should take thermal issues into consideration, which preferably are done via thermo-elastic FEM simulations. After that, the same methods suggested for existing machine tools, will be effective. The most relevant gap in the state of the art is the lack of interconnection between these methods. In the future, ERP, CAM and the NC control must all cooperate to maximize the effects of these energy-efficiency measures for any given workpiece.

By examining the interactions of the thermal accuracy of a machine tool with its energy efficiency, particularly via methods and devices that affect these critical goals, the authors have demonstrated many synergies between these seemingly conflicting goals and also possible solutions in cases where increased energy-efficiency truly leads to larger thermal errors, when these are not otherwise dealt with.

**Acknowledgement.** This research was funded by a German Research Foundation (DFG) grant within the Collaborative Research Centers (CRC) / Transregio (TR) 96, Project ID 174223256 – TRR96, which is gratefully acknowledged.

## References

1. Youssef, H.A., El-Hofy, H.: *Machining Technology*. CRC Press, USA (2008)
2. International Energy Agency IEA: *World Energy Outlook* (2021)
3. International Energy Agency IEA: *Electricity Market Report*, Jan (2022)
4. Schischke, D.-I.K.: *Machine tools and related machinery*. Fraunhofer Institute for Reliability and Microintegration, IZM, Berlin (2012)
5. Lay, G.: *Anforderungen an die Fertigungstechnik von morgen*. In: *Mitteilungen aus der Produktionsinnovationserhebung Nr. 37*, September, Fraunhofer ISI (2005)
6. Grossmann, K. (ed.): *Thermo-energetic Design of Machine Tools: A Systemic Approach to Solve the Conflict Between Power Efficiency, Accuracy and Productivity Demonstrated at the Example of Machining Production*. Springer (2014)
7. Regel, J., Bräunig, M., Richter, C., Putz, M.: *Industrial relevance and causes of thermal issues in machine tools*. In: *Proc. 1<sup>st</sup> Conf. on Thermal Issues in Machine Tools* (2018)
8. Denkena, B., Abele, E., Brecher, C., Dittrich, M.-A., Kara, S., Mori, M.: *Energy efficient machine tools*. *CIRP Ann. Manuf. Technol.* **69**, 646–667 (2020)

9. Semmler, U., Bräunig, M., Drossel, W.G., Schmidt, G., Wittstock, V.: Thermal Deformations of Cutting Tools: Measurement and Numerical Simulation. In: *Production Engineering – Research and Development*, no. 8, pp. 543–550 (2014)
10. Glänzel, J.: *Korrektur thermoelastischer Verformungen durch den Einsatz der adaptiven FEM*. Dissertation, TU Chemnitz (2014)
11. Liu, C., Xiang, S., Lu, C., Wu, C., Du, Z., Yang, J.: Dynamic and static error identification and separation method for three-axis CNC machine tools based on feature workpiece cutting. *Int. J. Adv. Manuf. Technol.* **107**(5–6), 2227–2238 (2020). <https://doi.org/10.1007/s00170-020-05103-5>
12. Li, Y., Meng, X., Zhang, Z., Song, G.: A machining state-based approach to tool remaining useful life adaptive prediction. *Sensors* **20** (2020). <https://doi.org/10.3390/s20236975>
13. Li, L., Liu, F., Chen, B., Li, C. B.: Multi-objective optimization of cutting parameters in sculptured parts machining based on neural network. *J. Intell. Manuf.* **26**(5), 891–898 (2015)
14. Han, F., Li, L., Cai, W., Li, C., Deng, X., Sutherland, J.W.: Parameters optimization considering the trade-off between cutting power and MRR based on linear decreasing particle swarm algorithm in milling. *J. Clean. Prod.* **262** (2020). <https://doi.org/10.1016/j.jclepro.2020.121388>
15. Vijayaraghavan, A., Dornfeld, D.: Automated energy monitoring of machine tools. *CIRP Annals* **59**(1), 21–24 (2010). <https://doi.org/10.1016/j.cirp.2010.03.042>
16. Pinedo, M.: *Scheduling*, vol. 29. Springer, Berlin, Heidelberg (2012)
17. Brecher, C., Bäuml, S., Jasper, D., Triebs, J.: Energy efficient cooling systems for machine tools. In: *Leveraging Technology for a Sustainable World*, pp. 239–244. Springer, Berlin (2012)
18. Campitelli, A., Cristobal, J., Fischer, J., Becker, B., Schebek, L.: Resource efficiency analysis of lubricating strategies for machining processes using life cycle assessment methodology. *J. Cleaner Prod.* **222**, 464–475 (2019). <https://doi.org/10.1016/j.jclepro.2019.03.073>
19. Mayr, J., et al.: Thermal issues in machine tools. *CIRP Ann. Manuf. Technol.* **61**, 771–791 (2012)
20. Großmann, K., et al.: *Thermo-Energetic Design of Machine Tools, A Systemic Approach to Solve the Conflict Between Power Efficiency, Accuracy and Productivity Demonstrated at the Example of Machining Production*. Springer International Publishing, Switzerland (2015)
21. Mitsubishi, M., Warisawa, S., Hanayama, R.: Development of an intelligent high-speed machining center. *CIRP Annals* **50**(1), 275–280 (2001)
22. Weber, J., Steiert, C., Weber, J., Shabi, L.: Investigation of the thermal and energetic behavior and optimization towards smart fluid systems in machine tools. *Proc. CIRP* **99**, 80–85 (2021)
23. Wenkler, E., Selch, S., Hellmich, A., Ihlenfeldt, S.: Process concatenation to reduce thermal changes in machine tools. In: *Int. J. of Mechatronics and Manufacturing Systems*. Special Issue: Artificial Intelligence in Advanced Manufacturing (2022)
24. Shabi, L., Weber, J., Weber, J.: Analysis of the energy consumption of fluidic systems in machine tools. In: *The 50th CIRP Conference on Manufacturing Systems*, Taiwan (2017)
25. Weber, J., Weber, J.: Thermo-energetic modelling of fluid power systems. In: Großmann, K. (ed.) *Thermo-energetic Design of Machine Tools*. LNPE, pp. 49–59. Springer, Cham (2015). [https://doi.org/10.1007/978-3-319-12625-8\\_5](https://doi.org/10.1007/978-3-319-12625-8_5)
26. Shabi, L.: *Thermo-energetisch optimierte Fluid-Systeme für*. Shaker Verlag, Düren (2020)

**Open Access** This chapter is licensed under the terms of the Creative Commons Attribution 4.0 International License (<http://creativecommons.org/licenses/by/4.0/>), which permits use, sharing, adaptation, distribution and reproduction in any medium or format, as long as you give appropriate credit to the original author(s) and the source, provide a link to the Creative Commons license and indicate if changes were made.

The images or other third party material in this chapter are included in the chapter's Creative Commons license, unless indicated otherwise in a credit line to the material. If material is not included in the chapter's Creative Commons license and your intended use is not permitted by statutory regulation or exceeds the permitted use, you will need to obtain permission directly from the copyright holder.







# Investigation of Cutting Force and Surface Quality in Frozen Wood Sawing Under Varying Influencing Factors to Improve the Energy- and Resource Efficiency of Sawing Processes

F. Schreiner<sup>1</sup>(✉), J. Schmidt<sup>1</sup>, B. Thorenz<sup>1,2</sup>, M. Voigt<sup>1</sup>, and F. Döpfer<sup>1,2</sup>

<sup>1</sup> University of Bayreuth, Chair Manufacturing and Remanufacturing Technology, Universitätsstraße 30, 95447 Bayreuth, Germany  
Florian.Schreiner@uni-bayreuth.de

<sup>2</sup> Fraunhofer IPA Project Group Process Innovation, Universitätsstraße 9, 95447 Bayreuth, Germany

**Abstract.** Wood as a renewable material plays an important role in transforming society towards sustainability and climate neutrality. However, wood is a difficult material to saw due to its anisotropic and inhomogeneous properties. Currently, the adaption of process parameters due to varying wood temperature and moisture content are solely based on operator experience. This frequently results in unfavorable settings of process parameters leading to a drastic increase in energy consumption and poor surface quality of the sawn wood. This paper investigates the cutting force when sawing frozen spruce wood with a two tooth research saw blade and the surface quality of the resulting wood samples under varying influencing factors. The material properties temperature between 20 °C and – 40 °C and moisture content as well as the kinematic factor cutting direction were observed. The results show that the cutting force of moist and wet wood increase with decreasing temperature and remain constant for dry wood. Additionally, the surface quality of wet and dry wood samples is improved when sawing wood with lower temperature values. Using these results, the operator can be supported by a data driven approach for the adaption of machining parameters, hence improving the energy- and resource-efficiency of the process.

**Keywords:** Frozen spruce wood · Wood sawing · Cutting force · Surface quality · Frozen wood · Temperature · Moisture content · Cutting direction

## 1 Introduction

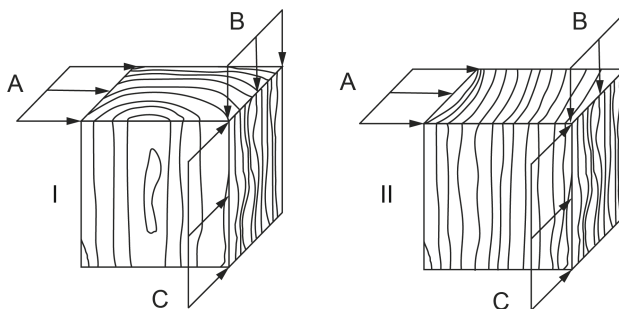
As a renewable and carbon-storing raw material, wood is becoming increasingly important in numerous industries. Taking into account dwindling resources and increasing competition between sawmills, the sawing processes themselves must become more sustainable and thus resource as well as energy efficiency are becoming increasingly important factors for the woodworking industry [1].

Particularly densely forested regions, such as Canada or Scandinavia, face the problem of temperatures dropping well below  $-40\text{ }^{\circ}\text{C}$  in winter months [2]. Due to the low temperatures, sawmills face the challenge of sawing frozen wood, which can lead to higher cutting forces and a reduction in cutting accuracy [3]. In order to keep the surface quality and process efficiency constant, the parameters of the sawing lines are usually adjusted based on operator experience. GREIGERITSCH recommends reducing the technologically possible feed speed of the sawing line by 15% when sawing frozen wood compared to sawing unfrozen wood [1]. In addition to this reduction in productivity, unfavorably set production parameters can lead to the circular sawing process being brought to a halt due to overloaded circular saw blades, which increases production downtimes and causes considerable economic damage.

## 2 State of the Art

### 2.1 Wood as a Material

The natural composite material wood is characterised by a high degree of anisotropy and inhomogeneity, which results from the cellular compound and the changing growth phases. Therefore, the directional influence must be taken into account when sawing wood. KIVIMAA was able to identify the three main cutting directions: A, B and C (see Fig. 1). The distinguishing feature for the determination of the main cutting direction is the orientation of the cutting surface and knife movement to the fibres. With cutting direction A, the cutting surface and the knife movement are perpendicular to the fibres. Cutting direction B is characterized by the cutting surface and knife movement being parallel to the fibres. Cutting direction C has the same cutting surface as B, but the knife movement is perpendicular to the fibres [4].



**Fig. 1.** Schematic representation of the three fibre cutting directions A, B, C in two cutting instances I and II [4]

### 2.2 Sawing Frozen Wood

Circular sawing of frozen wood has always represented a special challenge for sawmills throughout time. Particular attention ought to be paid to the changed physical and

mechanical properties of frozen wood. From various publications it is known that the mechanical properties of wood are influenced by wood temperature and moisture content (e.g. [5, 6]).

At temperatures below 0 °C, complex freezing processes take place within the wood. Solely the free water in the macroscopic cavities of the wood freezes thereby forming ice in these cavities. In the process, the ice expands and exerts a compressive stress on the cell walls. This supports the wood structure and makes it more rigid. The bound water in the microscopic cavities, however, remains in a liquid or liquid-like state even at temperatures below 0 °C. The reason for this is assumed to be the special bond to the cell walls, whereby the bound water is present as a supercooled liquid and strongly bound semi-fluid. Since there is a lower vapour pressure over ice than over supercooled or bound water, there is a potential difference between the microscopic and macroscopic cavities in the wood. This in turn causes moisture to migrate away from the cell walls and to freeze in the macroscopic cavities. The potential difference increases with decreasing temperature. This process leads to an internal drying of the wood, which in turn changes the mechanical properties [7, 8].

KIVIMAA has already dealt with temperature as an influencing factor. He reports that the cutting force increases linearly with decreasing temperature and shows a step at 0 °C [4]. The models of AXELSSON, LUNDBERG & GRÖNLUND and PORANKIEWICZ et al. agree with the results of KIVIMAA, but do not take into account the step change of the cutting force at 0 °C, as this was not included in the experimental design [9, 10]. The fact that sawing frozen wood requires more force and energy than unfrozen wood has been established in many studies (e.g. [11]). In contrary to the previously mentioned, ISPAS & CÂMPEAN have determined a reduction in cutting forces and energy consumption [12]. An adjusted saw blade and a low cutting height were used, which avoided the common phenomenon of large quantities of sawdust getting stuck on the lateral kerf walls, thus decreasing the frictional resistance.

### 2.3 Surface Quality of Sawn Wood

Measuring the surface quality of wood poses multiple challenges due to the properties of wood, such as inhomogeneity, anisotropy and porosity [13, 14]. Since 2019, a standardized procedure for the assessment of wood surfaces has been available in the form of VDI standard 3414 [15]. The following roughness parameters are recommended for the characterization of wood surfaces: core roughness  $Rk$  and reduced peak height  $Rpk$  as evaluation parameters and reduced valley depth  $Rvk$  as reference parameter [15]. The reduced valley depth  $Rvk$  can be understood as a measure of structural roughness, the reduced peak height  $Rpk$  as a measure of protruding fibres and the core roughness  $Rk$  as a measure of machining roughness [16]. If the condition of the surface is considered over an area and examined with 3D measuring instruments as it was done in this paper, the equivalent parameters from DIN EN ISO 25178–2 are relevant (core height  $Sk$ , reduced peak height  $Spk$ , reduced dale height  $Svk$ ) [15].

### 3 Approach and Experimental Detail

The general test set-up is shown in Fig. 2. The different wood samples are held on the machine table. The research saw blade with two exchangeable saw teeth is clamped in the sensory tool holder “spike” of the manufacturer pro-micron. The machine is a 5 axis machining centre machine DMU 50 eVolution from Deckel Maho. It guarantees an exact tool rotational speed and ensures a constant feed speed. The sensory tool holder “spike” can be used to measure various torques and forces. The cutting forces are recorded by the spike during the machining of the wood inside the machining centre and sent wirelessly to the receiver unit with antenna. This is located outside the machining centre and is connected to the measuring computer. All measured data are visualised and documented by the measuring computer.

The recorded measurement data is then processed. For this work, the decisive feature is the cutting force that the machine tool has to generate in order to machine the wood. This also includes the dynamic oscillations in the measurement signals. To map these correctly, the measurement signal is processed as follows:

- Removal of the linear drift
- Formation of the absolute value of the measured data
- Averaging of the data during the full engagement phase

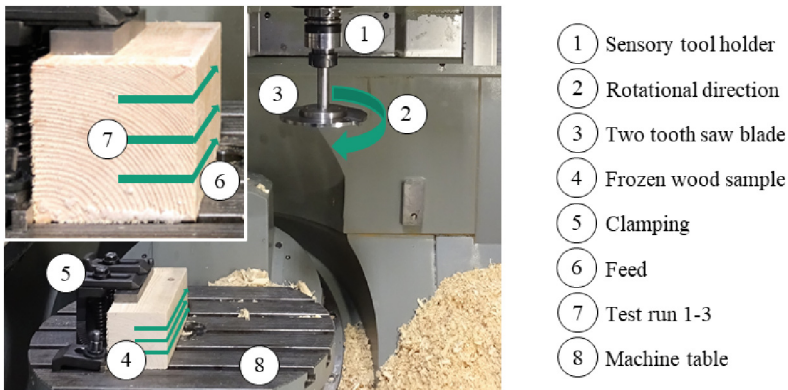


Fig. 2. General test set-up

The tests are carried out on spruce wood. The dimensions of all wood samples are  $90 \times 90 \times 180$  mm. To ensure equal conditions for the tests, the squared logs were taken from a few stems. To investigate the influence of the different moisture contents, a part of the samples was air-dried in a warm dry environment and another part was stored in water until the maximum moisture content was reached. The moisture content of the wood samples was determined using the darr method. The dry samples had an average moisture content of 4%, the green, “moist” samples a moisture content of 35% and the wet samples a moisture content of 200%.

The wood samples are machined in a laboratory environment at ten different temperature levels dry, moist and wet respectively in the three cutting directions A, B and C in counter-rotation. This is done for all samples at a tool rotational speed of  $n = 330$  rpm, a feed speed of  $v_f = 1066.88$  mm/min and a working engagement of the cutting edge of  $a_e = 40$  mm. The wood samples are sawn both at room temperature (20 °C) and at wood temperatures between 0 °C and -40 °C in 5 °C decrements. Three samples are machined per setting, with three cuts sawn into each sample. The wood samples are cooled down gradually to the next lower temperature level over a duration of at least 24 h using an adjustable heavy-duty laboratory freezer. A temperature sensor inserted into a reference wood sample is used to monitor and control the temperature of the wood samples.

The surfaces of the sawn wood samples are examined in the connection with the 3D profilometer VR-5200 from Keyence. The parameters for the examination of the surface in this work can be found in Table 1.

**Table 1.** Parameters of surface examination

Parameter	Value	Parameter	Value
Magnification	40 × (micro camera)	S-filter (low pass filter)	None
Measuring field	8 mm × 8 mm	L-filter (high pass filter)	8 mm
Filter type	Gaussian filter	F-operation (shape correction)	Secondary curved surface
End effect correction	On		

Regression lines with confidence and prediction intervals were calculated from the different measuring points between 0 °C and -40 °C. This applies to both the cutting forces and the surface parameters.

## 4 Results and Discussion

### 4.1 Cutting Force

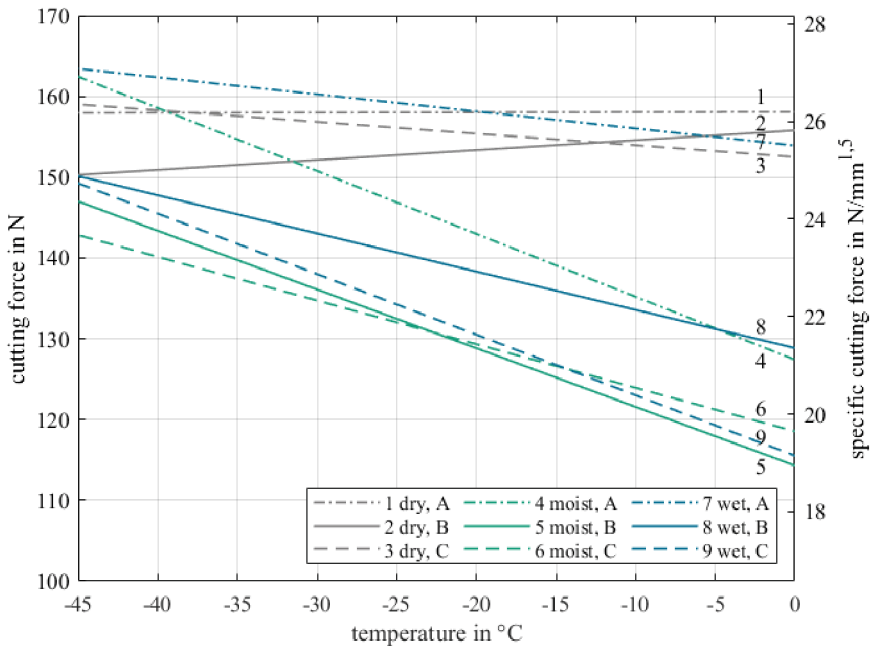
Comparing the cutting forces when machining the wood samples at 20 °C and at 0 °C (frozen), steps in the cutting force have been observed for the moist and wet wood samples. The cutting forces during machining the dry wood samples do not show any step during the transition to the frozen state.

The results of the cutting force tests (regression lines) on frozen wood are shown in Fig. 3. It can be clearly seen that the cutting force increases with decreasing temperature when machining the moist and wet wood samples, irrespective of the cutting direction. In contrast, a constant course of the cutting force can be assumed for machining the dry wood samples, whereby all three cutting directions show an approximately equal cutting force. This is consistent with the results of various investigations of the mechanical properties of wood. At low moisture levels, temperature has only a minor influence.

With increasing moisture, the effects of temperature on mechanical properties increase, with the effect being more pronounced at temperatures below 0 °C than at temperatures above 0 °C [5].

Furthermore, it is noticeable that the cutting force in cutting direction A is significantly higher than in cutting direction B and C for the moist and wet wood samples. It must be mentioned that the scatter of the measured values in cutting direction A is very high compared to cutting direction B and C. This results in large confidence intervals, which leave a lot of latitude for the actual curves of the regression lines. The large range of the cutting force in cutting direction A is already known and can vary by  $\pm 30\%$  for spruce wood [17].

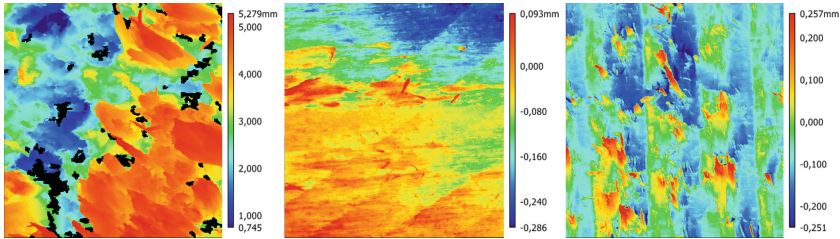
In cutting direction B it can be seen that the moist wood samples are easier to machine than the wet wood samples, which in turn are easier to machine than the dry wood samples. In cutting direction C, the cutting forces of the moist and wet wood samples are near each other. The behavior described for cutting direction B applies in cutting direction C at a temperature lower than  $-15$  °C. At temperatures above this it is easier to machine wet wood samples than moist wood samples. The lower the temperature decreases, the smaller the difference between the moisture levels becomes.



**Fig. 3.** Results of the cutting force tests of frozen wood (regression line). The cutting tests incorporate the three cutting directions A, B, and C (see Fig. 1) as well as the three different moisture contents dry, moist and wet.

## 4.2 Surface Quality

Figure 4 shows the surface topographies of wood samples which were sawn in cutting direction A, B and C.



**Fig. 4.** Surface topography of wet wood samples at  $-20\text{ }^{\circ}\text{C}$  for cutting direction A (left), cutting direction B (center) and cutting direction C (right)

In the following, the focus is on core height ( $Sk$ ), because the tests have shown that this parameter is generally more dominant than the reduced peak height ( $Spk$ ) and reduced dale height ( $Svk$ ). No significant change or step in surface quality can be detected when the wood is transitioned to the frozen state. While the surface quality of the dry and wet wood samples increases when the temperature is reduced, the surface quality of the moist wood samples deteriorates or remain approximately equal, (see Table 2). Thus, if the wood sample has a low moisture content or is completely saturated with water (wood-ice composite), the surface of the wood benefits from the changed material properties as the temperature decreases. The deviating behavior of the moist wood samples indicates that the simultaneous presence of ice in the macroscopic cavities and, with decreasing temperature, increasingly migrating (liquid or liquid-like) water in the microscopic cavities leads to a decrease in the surface quality with increasing drying of the wood fibers (internal drying).

Moreover, the wood samples machined in cutting direction B and C show significantly lower core height  $Sk$  values than the wood samples machined in cutting direction A. Basically, with the given process parameters, the machined surfaces in cutting direction A are characterized by very coarse structures with deep, exposed pores. In contrast, relatively smooth surfaces were produced in cutting direction B and C, where the knife marks were partly recognizable in the height profile.

**Table 2.** Change in surface quality between  $0\text{ }^{\circ}\text{C}$  and  $-40\text{ }^{\circ}\text{C}$  ( $(Sk_{-40} - Sk_0)/Sk_0$ )

Sample	Cutting direction A	Cutting direction B	Cutting direction C
Dry wood samples	-35,4%	-21,7%	-3,4%
Moist wood samples	+50,2%	-2,7%	+22,1%
Wet wood samples	-27,2%	-29,6%	-39,7%

## 5 Conclusion and Outlook

This paper has created a basis for a sustainable and efficient operation of circular saws and sawing lines. In general, the cutting forces when machining moist wood at temperatures below 0 °C are lower than the cutting forces when machining wet wood, and the cutting forces when machining wet wood are lower than the cutting forces when machining dry wood. The cutting forces for machining dry wood are constant for all three cutting directions. If the wood is moist or wet, the cutting forces increase in all three cutting directions as wood temperature levels are dropping. When considering the surface of the wood, a reduction in temperature for the dry and wet wood samples causes an improvement in the surface quality during machining. The moist wood samples behave in the opposite way for cutting directions A and C. In general, the cutting forces are greatest in cutting direction A and very close to each other in cutting directions B and C. The surface quality in cutting direction B and C is clearly better than the surface quality in cutting direction A. Basically, the machining roughness is more dominant than the protruding fibers and the structural roughness.

With regard to temperature and moisture content, further investigations with a higher resolution of both influencing factors may be useful. Especially for moisture content, there are still large gaps between the considered levels of 4%, 35% and 200%. Future research can also tie in by collecting, combining, evaluating and interpreting various data, for example from cutting forces, acoustic noise, current profiles and rotation position of the saw blade. Using suitable methods such as artificial intelligence or machine learning, new perspectives for the optimal operation of saw lines can be generated. The field of sensor data fusion has great potential in woodworking.

## References

1. Greigeritsch, T.: Neue Methoden zur Planung und Optimierung der Schnittholzproduktion von Nadelholzsägewerken. Gabler, Wiesbaden (2009)
2. Pfadenhauer, J.S., Klötzli, F.A.: *Vegetation der Erde*. Springer, Berlin, Heidelberg (2014)
3. Orłowski, K., Palubicki, B.: Recent progress in research on the cutting processes of wood. *Holzforschung* **63**, 181–185 (2009)
4. Kivimaa, E.: *Cutting Force in Wood-Working*. Dissertation, Finland's Institute of Technology, Helsinki (1950)
5. Gerhards, C.: Effect of moisture content and temperature on the mechanical properties of wood: an analysis of immediate effects. *Wood Fiber* **14**(1), 4–36 (1982)
6. Hernández, R.E., Passarini, L., Koubaa, A.: Effects of temperature and moisture content on selected wood mechanical properties involved in the chipping process. *Wood Sci. Technol.* **48**(6), 1281 (2014)
7. Kubler, H., Liang, L., Chang, L.: Thermal expansion of moist wood. *Wood Fiber* **5**(3), 257–267 (1973)
8. Ilic, J.: Advantages of prefreezing for reducing shrinkage-related degrade in eucalypts: general considerations and review of the literature. *Wood Sci. Technol.* **29**, 277–285 (1995)
9. Axelsson, B., Lundberg, Å., Grönlund, J.: Studies of the main cutting force at and near a cutting edge. *Holz als Roh- und Werkstoff* **51**, 43–48 (1993)
10. Porankiewicz, B., Axelsson, B., Grönlund, A., Marklund, B.: Main and normal cutting forces by machining wood of *Pinus sylvestris*. *BioResources* **6**(4), 3687–3713 (2011)



11. Schmidt, C., Westermann, H.-H., Thorenz, B., Steinhilper, R.: Sustainability of cutting frozen wood – an analysis of buzz saw blades cutting performance depending on wood temperature. *Procedia Manuf.* **25**, 263–270 (2018)
12. Ispas, M., Câmpean, M.: Experimental research on sawing frozen wood. *Bull. Transilvania Univ. Braşov* **7**(1), 51–58 (2014)
13. Sinn, G., Sandak, J., Ramanantoandro, T.: Properties of wood surfaces – characterisation and measurement. *Holzforschung* **63**, 196–203 (2009)
14. Goli, G., Sandak, J.: Proposal of a new method for the rapid assessment of wood machinability and cutting tool performance in peripheral milling. *Eur. J. Wood Prod.* **74**(6), 867–874 (2016)
15. Verein Deutscher Ingenieure e.V.: VDI 3414: Quality evaluation of wood and wood-based surfaces: Part 2 Testing and measuring methods. Beuth Verlag, Berlin (2019-02)
16. Gottlöber, C.: *Zerspanung von Holz und Holzwerkstoffen*. Carl Hanser, Munich (2014)
17. Wagenführ, A., Scholz, F. (eds.): 3rd edn. Carl Hanser, Munich (2018)

**Open Access** This chapter is licensed under the terms of the Creative Commons Attribution 4.0 International License (<http://creativecommons.org/licenses/by/4.0/>), which permits use, sharing, adaptation, distribution and reproduction in any medium or format, as long as you give appropriate credit to the original author(s) and the source, provide a link to the Creative Commons license and indicate if changes were made.

The images or other third party material in this chapter are included in the chapter's Creative Commons license, unless indicated otherwise in a credit line to the material. If material is not included in the chapter's Creative Commons license and your intended use is not permitted by statutory regulation or exceeds the permitted use, you will need to obtain permission directly from the copyright holder.





# revolPET<sup>®</sup>: An Innovative “Back-to-Monomer” Recycling Technology for the Open Loop Value Chain of PET and Polyester Composite Packaging and Textiles

Renan Louro Cardoso Franco<sup>1</sup>(✉), Carsten Eichert<sup>1</sup>, Charlotte Lücking<sup>1,2</sup>,  
Lars Biermann<sup>1,2</sup>, Mandy Paschetag<sup>2</sup>, and Stephan Scholl<sup>2</sup>

<sup>1</sup> RITTEC Umwelttechnik GmbH, Moorweide 13, 21339 Lüneburg, Germany  
{franco, eichert}@rittec.eu

<sup>2</sup> Institute for Chemical and Thermal Process Engineering (ICTV), Technische Universität  
Braunschweig, Langer Kamp 7, 38106 Braunschweig, Germany

**Abstract.** Nowadays there is a need for innovative solutions for composite materials in the packaging and textile sectors. These are formed by multilayer structures that improve technical performance however complicates recycling. Consequently, they are mostly sent to energy recovery or downgrade recycling processes. To avoid this, new recycling technologies are needed.

The innovative “back-to-monomer” recycling technology “revolPET<sup>®</sup>” represents a solution for this challenge. In the process, the polyethylene terephthalate (PET) is selectively depolymerized to recover the monomers ethylene glycol (EG) and terephthalic acid (TA) for a new PET production. By an alkaline hydrolysis, the PET reacts continuously with a strong base in a twin-screw extruder. The average residence time in the extruder is less than one minute with a process yield up to 95%. Due to the mild depolymerization conditions, the other polymers remain chemically unchanged and can be easily separated. The produced monomers are regained in virgin quality and can achieve a 33% reduction on the greenhouse gases emissions if compared with the crude oil production route.

In this contribution, the technology on a pilot scale as well as the results of the first scale-up investigations are presented and discussed with respect to technical maturity and environmental benefit.

**Keywords:** PET · Recycling · Depolymerization · Circular economy · Sustainability

## 1 Introduction

The global production of PET in the year of 2018 was about 78 million tons. Around 98% of its production was obtained from non-renewable resources and just 2% from secondary raw materials (recyclates) [1]. PET is most used in the manufacture of high-quality plastic packaging and polyester textiles. Due to its mechanical properties, this

polymer shows a good resistance against many chemicals and for this reason it meets the highest quality for food packaging. For some packaging applications, there is a need of protecting the inner content against light and air exposure. Therefore, the combination of different polymers (multilayer structure) is a viable solution for the packaging industry to fulfill specifications concerning low material consumption, high propensity against O<sub>2</sub> permeation and mechanical strength [2]. Since raw materials are primarily derived from non-renewable sources, a sustainable approach for recycling PET-containing waste is essential. Furthermore, almost all the economic value of these materials are lost in their short-lived value chain. Recycling technologies present a solution for this challenge, as they provide a secondary raw material that can substitute and thus reduce the use of non-renewable resources to produce new PET. The depolymerization products can be recovered in high quality, so that PET can be produced in novel quality, which is suitable e.g. for food-contact applications.

The most established recycling technologies for PET are mainly thermomechanical processes, which are only applicable for high purity PET feed materials. Mechanical recycling of PET composite waste is technically and economically not viable due to the required polymer separation. As a result, these materials are mostly sent to energy recovery. However, the economic value as well as the resources of the waste stream cannot be recovered, and the product comes shortly to the end of its life cycle. Targeting these “hard-to-recycle” PET materials, the company RITTEC Umwelttechnik GmbH developed the innovative “back-to-monomer recycling” (BMR) technology revolPET.

### 1.1 State of the Art (Depolymerization of PET)

Chemical methods can supplement the mechanical recycling technologies to treat the “hard-to-recycle” waste fractions. PET feedstock recycled with pyrolysis, requires mostly high operation temperatures (450 °C...900 °C) and none of the developed technologies was able to prove itself economically viable. Furthermore, PET has not become the focus of pyrolysis research because of unfavorable composition of the decomposition products (bulk petrochemicals) [3, 4]. In addition to pyrolysis, the BMR methods, based on depolymerization, offers a possible solution for the aforementioned challenge. BMR processes are focused on recovering the monomers or other constitutional repetition units of the polymer for a new PET production [5]. These processes are, regarding their reaction pathways, divided into: ammonolysis, glycolysis, methanolysis and hydrolysis [6]. This contribution will focus on the hydrolysis processes.

The hydrolysis of PET is carried out in the presence of water either utilizing catalysts, high pressure, and high temperature or with strong bases and acids [7, 8]. In presence of strong bases, the ester linkages of PET are dissolved, resulting on EG and two salts (monosodium terephthalate and disodium terephthalate (DST)) [9]. After a further treatment of DST with a strong acid, both valuable monomers EG and TA can be recovered [9, 10]. Normally, alkaline hydrolysis processes are operated with high base concentrations (up to 20 wt.%), pressures around 1.4...2.0 MPa and high temperatures (up to 250 °C) [11, 12]. These last-mentioned points combined with a batch operation make these hydrolysis processes economically unviable for the PET depolymerization.

Given the growing volumes of PET being produced, there is a great economic and environmental need of developing a sustainable process solution for the depolymerization of PET. Compared to batch processes, continuous production offers many benefits regarding energy and resource efficiency, constant product quality and scalability. Moreover, the difficulty to increase the heat transfer area on scaling batch processes leads to longer residence time and lower reaction rates [13]. The most promising continuous alkaline depolymerization process was presented by Benzaria et al. [14]. The reaction took place in a kneading extruder at 120–160 °C with a residence time of approx. 6 min with a depolymerization degree above 60%. After the implementation of a further downstream process step operating at 80...130 °C for 30 min, a higher depolymerization degree (>95%) was achieved [14].

## 1.2 The Background of the revolPET Technology

In a joint R&D activity, RITTEC Umwelttechnik GmbH together with the Institute for Chemical and Thermal Process Engineering (TU Braunschweig) developed a continuous PET depolymerization technology. The newly developed revolPET process builds on the continuous operation of a twin-screw extruder leading to a residence time below 1 min and to high depolymerization degrees [15]. Furthermore, hydrolysis depolymerization has a great advantage in comparison to other processes because the produced TA can be directly used for a new PET production without further processing [16].

## 2 Materials and Methods

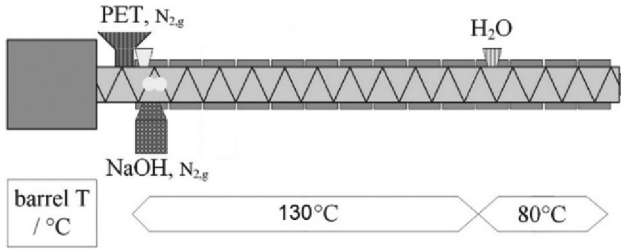
### 2.1 Process Concept and Experimental Setup

The process concept and the experimental setup were first presented in Biermann and Brepohl [15]. In a pilot plant, 6.96 kg/h PET waste material and 3.04 kg/h sodium hydroxide (NaOH) is conveyed into the twin screw extruder. The stoichiometric ratio of PET waste to NaOH is adjusted to 2.1 molNaOH/molPET calculated assuming 100% PET content on the PET waste stream.

The post-consumer multilayer PET trays were mixed with post-consumer monolayer trays and bottles. The trays were extracted from the waste stream and a second sorting was applied to extract the multilayer trays only. The stream contained a minimum 80% of multilayer trays and was ground to <3 mm in diameter. The material was processed in the extruder (ZSE 27 MAXX, Leistritz Extrusionstechnik GmbH) and NaOH (purity  $\geq 98\%$ , diameter < 3 mm) was added through a side feed in cylinder number 2. The temperature of the reaction zone was set to 130 °C, see Fig. 1.

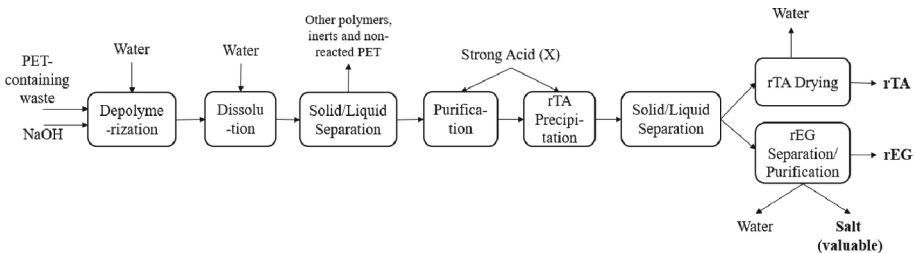
Following the depolymerization, the extruder output was conveyed in a dissolution tank where 66.9 l/h water is added. After the complete dissolution of all dissolvable materials, the suspension is sent to a filtration cascade where solid impurities are removed in a two-stage filtration. The particle free solution of DST and EG in water is purified from soluble impurities. The isolation of recycled TA (rTA) is conducted by the addition of a strong acid.

By solid/liquid separation the rTA is extracted from the product suspension and sent to the drying process. The filtrate is sent to the recycled EG (rEG) purification



**Fig. 1.** Continuous revolPET depolymerization process (adapted from [15]).

process where the water is removed and the rEG is distilled to obtain the required purity. Figure 2 presents a block diagram of the revolPET process. To date, the process has focused on recovering the monomers rTA and rEG, future technology developments will also address the sodium salt (Na-X).



**Fig. 2.** Block diagram of the revolPET process.

After the isolation, rTA and rEG were repolymerized in a lab scale experiment to test the resulting polymer quality. Up front rTA (1.98 mol), virgin isophthalic acid (IA) (0.02 mol), diethylene glycol (DEG) (0.015 mol), a polymerization catalyst and the rEG (2.4 mol) were premixed and filled into the reactor. Subsequently, the reactor has been heated up to start the polymerization. After reaching a clear prepolymer melt, the polycondensation conditions were applied to remove water from the reaction equilibrium.

## 2.2 Environmental Assessment of the revolPET Process

For the revolPET process, a Life Cycle Assessment (LCA) was conducted following a cradle-to-gate approach based on the framework of ISO 14040/44 [17]. For the LCA considerations, holistic investigations were performed to identify parameters with a strong influence on the environmental impact. As the current technology readiness level (TRL) of the process holds a lot of potential for improvement (TRL 4), various studies were conducted to identify hotspots and opportunities that must be considered in the ongoing process development. It builds on analyses of the operation of a single process step, apparatus, or unit operation and the entire process as well as the site infrastructure.

Following the approach of Wesche [18], all inputs and outputs of the process are included in the investigation, i.e. the expenditures for providing the reactants, utilities, and auxiliaries, as well as the electricity, process emissions and the waste disposal.

The system boundaries include the expenditures of the recycling process, except for impacts of service and maintenance as well as the production plant and connected infrastructure itself, since the design is still not finalized. The production of 1 kg rTA is used as the functional unit. The inventory is mainly based on primary data collected from measurements and experiments at the pilot scale regarding the continuous processing of 14 kg/h of PET/PE waste fraction, complemented with calculations. The calculation of the elementary flows for the life cycle inventory is based on generic datasets from the ecoinvent database v3.7.1 [19]. For the life cycle impact assessment (LCIA), the characterization models described in the ReCiPe method [20] were used.

### 3 Results and Discussion

#### 3.1 Process and Technology-Related Results

The PET waste material was depolymerized in the twin screw extruder as described in Sect. 2.1. Since the PET content of the waste material is unknown, no degree of depolymerization could be calculated [15]. The analytical results are displayed in Table 1 and show the obtained quality of the rTA in comparison with industrially produced purified TA (PTA) from crude oil.

**Table 1.** Comparison of the rTA and rEG (revolPET) with virgin PTA and EG.

	Unit	rTA	typical values for PTA (virgin)	Industrial specification for PTA	rEG	Typical values for EG (virgin)	Industrial specification for EG
Color L*	–	95	95		100		
Color a*	–	–0.1	–0.4		0.0		
Color b*	–	1.5	1.5		–0.2		
Moisture	%(w/w)	0.1	0.1	0.2	1.3	0.05	<0.1
4-CBA	ppm	<5	10	<25			
4-MBS	ppm	29	160	<170			
IA	%(w/w)	1.4	0				
Hazen	–	7.1	1.2	<10	1	1	<10
DEG	%(w/w)				1.0	0.03	<1.0

It is shown that the values for the color and moisture of rTA match the industrial specifications and the typical values of PTA. Furthermore, the concentration of 4-Carboxybenzaldehyde (4-CBA) and 4-Methylbenzoic acid (4-MBS) exceeds the typical values of PTA. In contrast to the PTA, the rTA is a mixture of the isomers TA and IA.

IA is commonly added during the production of PET and influences the crystallization behavior of the material. It is therefore not considered an impurity. Concerning the rEG, the industrial specifications are as well met, except for the moisture content of the material. This may be tolerable during the polymerization process because water is removed from the polycondensation reaction equilibrium of PET.

The recycled monomers were repolymerized in a lab scale experiment to assess the quality of the resulting PET. For comparison purposes, a polymerization experiment with the same reaction conditions was applied with virgin PTA and EG as reference. The results are displayed in Table 2 and show that the values deviate from the reference by 5.5 at L\*, 0.8 at a\* and by 3.1 at b\*. The IV value of the recycled PET (rPET) is with 0.599 dl/g in a comparable regime.

**Table 2.** Comparison of the rPET from the chemically recycled monomers with virgin PET under identical lab conditions.

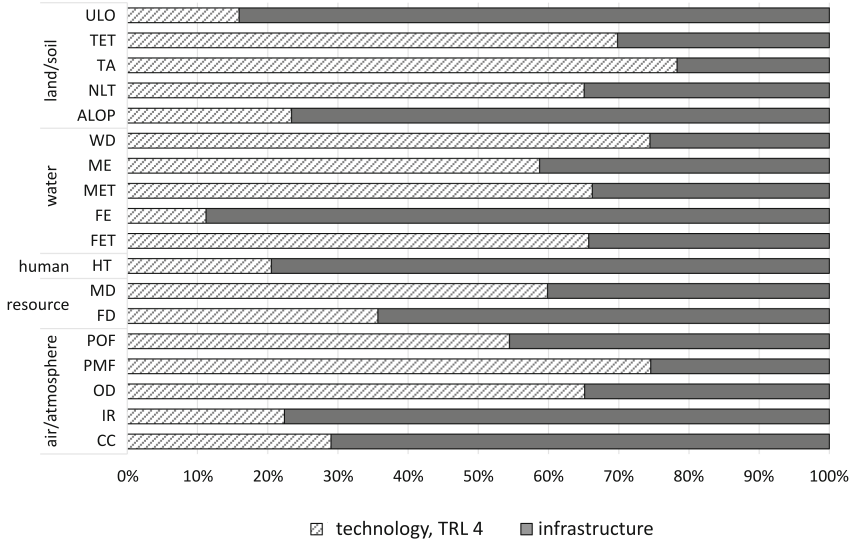
	IV/dl/g	L*	a*	b*
revolPET-PET	0.599	82.6	-0.8	8.6
Lab reference PET	0.606	88.1	-1.6	5.5

The rPET was furthermore analyzed for Non-Intended Added Substances (NIAS) by the Fraunhofer Institute of Process Engineering and Packaging. As a result, the recycled material follows the safety requirements of Article 3 of Regulation (EC) N° 1935/2004 for food-contact applications. In conclusion it was shown that mono- and multilayer food packaging can be recycled by the revolPET process to produce rTA and rEG in high quality, sufficient to produce rPET that meets the industrial requirements.

### 3.2 Environmental Assessment of the revolPET Process in the Current TRL

The results of the LCIA were subdivided in two parts: (1)-significantly influenced by the technology; (2)-mainly influenced by the type of energy supply employed, correlating with the available site infrastructure. This structure allows the presentation of the influence from TRL and the site infrastructure on the environmental assessment of the new developed recycling process. Figure 3 shows an excerpt of the LCA consideration, here the assignment of the environmental impacts with respect to the technology itself and the site infrastructure in the different impact categories.

The share of the technology part shows a variety of trends. For the impact category climate change (CC) less than 30% of the potential environmental impacts results from the process itself. The hotspot analyses also shows that the infrastructure share is largely influenced by the heat demand. The heat supply here in TRL 4 is ensured by electricity due to the existing infrastructure in the pilot plant (Braunschweig, Germany). The distribution in the category of water depletion (WD) is reversed, more than 70% of the total potential environmental impact is caused by the process, here mainly by the auxiliary materials. The results of the hotspot and the scenario analyses are used as a guidance for an environmentally beneficial process development and design. Furthermore, the influence



**Fig. 3.** Excerpt of the LCA results using the characterization models of the ReCiPe method [20].

of boundary conditions and parameters are highly dependent on the actual development stage.

Similarly, studies consider improving the TRL (TRL 4 à TRL 7) of the revolPET process as well as by changing the production site from the technical lab to an industrial park. Nevertheless, studies comparing the rTA production from the revolPET process with the fossil route are also conducted. Both, the increased TRL as well as the changed production site resulted in a significant reduction (14...34%) of the potential environmental impacts in all impact categories. The comparison of the revolPET process with the fossil production route of TA shows environmental benefits in the current development stage of the revolPET technology. For example, in a TRL 7 scenario, the potential environmental impacts in the category CC can be reduced by 33% by the revolPET process in an industrial park compared to the fossil production route.

## 4 Conclusions and Outlook

The innovative BMR revolPET technology was presented and discussed in this contribution. Regarding the process itself, revolPET presented a possible solution for PET composite materials, as the PET reacts selectively and continuously in a twin-screw extruder with depolymerization quotas up to 95% based on the PET fraction of the feed material under mild conditions (ambient pressure and 130 °C) and in less than 1 min. The produced monomers were analyzed, and it has been established that they have a similar quality as the virgin monomers. Looking at the environmental benefits of such innovative technology, the recycled monomers can reach a 33% reduction of CO<sub>2</sub>-emissions if their production in an industrial park is compared to the crude oil route. Furthermore, the caused environmental impact of the revolPET process can be reduced after scaling and optimizing the process.



For the further development of the revolPET process, a miniplant with a nominal throughput of 18 kg/h of PET composite waste is being built. It is planned to get a fully automated production, with heat and water recycling in the process, as well as the recovery of the valuable produced salt (Na-X) on his market specifications. In addition to these points, the application of the revolPET technology is being extended also for polyester composite textiles and should be addressed in following studies.

## References

1. Boon, E.: A global momentum to rethink the plastics system. In: PetCore Europe Conference (2018)
2. Kaiser, K., Schmid, M., Schlummer, M.: Recycling of polymer-based multilayer packaging: a review. *Recycling* **1**(3), 1 (2018)
3. Anuar Sharuddin, S.D., Abnisa, F., Wan Daud, W.M.A., Aroua, M.K.: A review on pyrolysis of plastic wastes. *Energy Convers. Manage.* **115**, 308–326 (2016)
4. Park, C., et al.: Pyrolysis of polyethylene terephthalate over carbon-supported Pd catalyst. *Catalysts* **10**, 496 (2020)
5. Dimitrov, N., Kratofil Krehula, L., Ptiček Siročić, A., Hrnjak-Murgić, Z.: Analysis of recycled PET bottles products by pyrolysis gas chromatography. *Polym. Degrad. Stab.* **98**(5), 972–979 (2013)
6. Lamparter, R.A., Mich, H., Barna, B.A., Las Cruces, N.M., Johnrud, D.R.: Process for recovering terephthalic acid from waste polyethylene terephthalate. United States Patent, US4542239 (1983)
7. Datye, K.V., Raje, H.M., Sharma, N.D.: Poly (ethylene terephthalate) waste and its utilisation: a review. *Resour. Conserv.* **11**(2), 117–141 (1984)
8. Yoshioka, T., Sato, T., Okuwaki, A.: Hydrolysis of waste PET by sulfuric acid at 150 °C for a chemical recycling. *J. Appl. Polym. Sci.* **52**, 1353–1355 (1994)
9. Oku, A., Hu, L.C., Yamada, E.: Alkali decomposition of poly (ethylene terephthalate) with sodium hydroxide in nonaqueous ethylene glycol: a study on recycling of terephthalic acid and ethylene glycol. *J. Appl. Polym. Sci.* **63**, 595–601 (1997)
10. Aguado, A., et al.: Chemical depolymerisation of PET complex waste: hydrolysis vs glycolysis. *J. Mater. Cycles Waste Manage.* **16**, 201–210 (2014)
11. Smuda, H.: Verfahren zur Gewinnung von Terephthalsäure und Ethyl-englykol, insbesondere aus Polyethylenterephthalat-Abfällen und Vor-richtung zur Durchführung des Verfahrens. German Patent, DE 19629042 C2 (1996)
12. Geyer, B., Lorenz, G., Kandelbauer, A.: Recycling of poly (ethylene terephthalate) – a review focusing on chemical methods. *Express Polym. Lett.* **10**, 559–586 (2016)
13. Kohlmann, D., Chevrel, M.C., Hoppe, S., Meimaroglou, D., Chapron, D., Bourson, P., et al.: Modular, flexible, and continuous plant for radical polymerization in aqueous solution. *Macromol. React. Eng.* **10**, 339–353 (2016)
14. Benzaria, J., Dawans, F., Durif-Varambon, B., Gaillard, J.B.: Method for recovery of alkali metal or alkaline-earth metal terephthalate and of alkylene glycol from polyethylene terephthalates. United States Patent, US5545746 (1995)
15. Biermann, L., Brepohl, E., Eichert, C., Paschetag, M., Watts, M., Scholl, S.: Development of a continuous PET depolymerization process as a basis for a back-to-monomer recycling method. *Green Process. Synth.* **10**, 361–373 (2021)
16. Karayannidis, G.P., Achilias, D.S.: Chemical recycling of poly (ethylene terephthalate). *Macromol. Mater. Eng.* **292**, 128–146 (2007)

17. Deutsches Institut für Normung e.V. DIN EN ISO 14044:2021-02: Umweltmanagement -Ökobilanz- Anforderungen und Anleitungen. Deutsche Fassung EN ISO 14044:2006 + A1:2018 + A2:2020. Beuth Verlag GmbH, Berlin. (2021)
18. Wesche, M., Häberl, M., Kohnke, M., Scholl, S.: Ökologische Bewertung von Produktionsprozessen in Mehrproduktbatchanlagen. *Chem. Ing. Tec.* **87**(3), 203–215 (2015)
19. Wernet, G., Bauer, C., Steubing, B., Reinhard, J., Moreno-Ruiz, E., Weidema, B.: The ecoinvent database version 3 (part I): overview and methodology. *Int. J. Life Cycle Assess.* **21**(9), 1218–1230 (2016)
20. Goedkoop, M., Heijungs, R., Huijbregts, M., De Schryver, A., Struijs, J., van Zelm, R.: ReCiPE 2008: A LCIA method which comprises harmonised category indicators at the midpoint and the endpoint level. Report I: Characterisation, 1st edn. (2013)

**Open Access** This chapter is licensed under the terms of the Creative Commons Attribution 4.0 International License (<http://creativecommons.org/licenses/by/4.0/>), which permits use, sharing, adaptation, distribution and reproduction in any medium or format, as long as you give appropriate credit to the original author(s) and the source, provide a link to the Creative Commons license and indicate if changes were made.

The images or other third party material in this chapter are included in the chapter’s Creative Commons license, unless indicated otherwise in a credit line to the material. If material is not included in the chapter’s Creative Commons license and your intended use is not permitted by statutory regulation or exceeds the permitted use, you will need to obtain permission directly from the copyright holder.





# Development of a Pneumatic Clamping System with Position and Force Control Machining

U. Ben-Hanan<sup>1</sup>(✉), U. Eckert<sup>2</sup>, M. Mende<sup>2</sup>, A. Weiss<sup>1</sup>, R. Wertheim<sup>1,2</sup>,  
and U. Azaria<sup>3</sup>

<sup>1</sup> ORT Braude College, Snunit Street 51, PO Box 78, 2161002 Karmiel, Israel  
ubenhana@braude.ac.il

<sup>2</sup> Fraunhofer IWU, 09126 Chemnitz, Germany

<sup>3</sup> Henri Azaria PAL Ltd., Tel Aviv, Israel

**Abstract.** Precision machining plays a vital role in modern, efficient, and sustainable manufacturing. Monitoring and controlling the clamping forces can influence positioning accuracy, workpiece deformation, thus improving the production outcome. The clamping force must be adapted to the cutting forces, workpiece geometry, and material properties to improve accuracy and control workpiece deformation during machining. The best devices available have a repeatability of  $\pm 1 \mu\text{m}$ , however, with limited precision and repeatability when re-clamping the workpiece. This paper presents the newly developed high-precision adaptable clamping system for controlled high-precision positioning and repositioning of a workpiece in the x-y plane with visual pattern recognition, adjustment, and controlled clamping forces. The clamping system is based on a pneumatic clamping chuck with controlled air pressure on a very accurate CNC machine. FEA calculations of thin-walled workpieces are used for designing associated jaws to ensure workpiece holding, limited forces and limited deformations. Once the workpiece has been removed and re-clamped with the defined forces, the vision device identifies the new workpiece position. Force and position data are collected and analyzed for calculating the repositioning movement in the x, y, and theta axes. The difference between the measured position after re-clamping and the reference position is calculated using a specially developed algorithm, yielding the motion commands to the x, y and theta axis. Using the vision system made it possible to identify an accuracy of  $\pm 1 \mu\text{m}$  and a repeatability of  $\pm 0.5 \mu\text{m}$ .

**Keywords:** Precision clamping · Position and force control · Pneumatic chuck

## 1 Introductions

Precision machining plays an essential role in modern and sustainable manufacturing in the automotive, aerospace, micro-machining, medical, robotics, and IT industries, including cutting, forming, and non-conventional processes. In machining, one of the challenges lies in re-clamping and repositioning the part after it has been removed and brought back to continue processing. Accurate re-clamping is a difficult task, which may require a long time to reposition and adjust the gripping force to avoid deflections and

deformations. Furthermore, often the workpiece must be held with small and accurate clamping forces to avoid deformation. However, the forces should be high enough to avoid or limit movement or deflection during machining. This paper describes the development and features of a precision pneumatic clamping solution for machining with controlled clamping forces combined with a very accurate visual position measurement device. In addition to improved quality, the new sustainable system provides shorter set-up times, simplicity in positioning and re-clamping, better control and selection of machining conditions, and fewer defective products and waste. The developed system allows for clamping force adjustment along the process chain, considering the machining conditions, thus improving quality, saving time, and reducing cost.

## 1.1 State of the Art

A high-precision method for machining flexible and accurate components using a pneumatic chuck is presented in [1], including the development of a unique tilting device to control inclination. Monitoring and controlling the clamping forces can influence positioning accuracy, workpiece deformation, thus improving the production outcome [2, 3]. In some cases, hybrid micro-machining techniques are implemented to achieve better performance [4]. A combination of work holding devices with sensing technologies and actuation systems is described in [5]. Different types of sensors, such as foils, piezoelectric devices, and strain gauges, can be used to measure and control the clamping forces [6]. In the current investigation, the calibration and experiments were carried out with strain gauges and piezo-electric sensors on a high-precision pneumatic chuck with three jaws for milling, produced by Henri Azaria, PAL, Israel [7]. The utilized machine vision technology is similar to the two CCDs used to measure tool positioning errors and compensation [8]. The limitations of position repeatability for workpiece re-clamping are based on geometrical tolerances, deformations, and clamping elements [9].

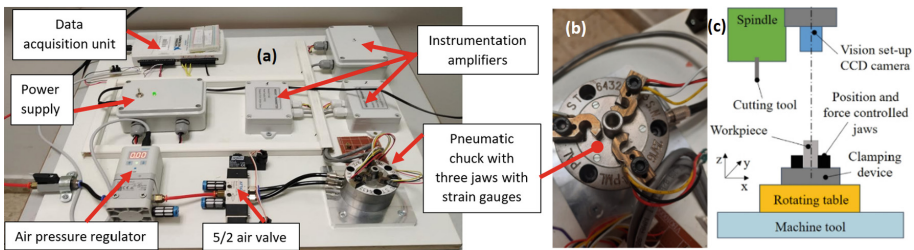
## 1.2 Definition of Goals

This investigation aims to define, simulate, develop, and analyze a clamping solution with controlled forces and a high-precision positioning device, especially for small and/or thin-walled workpieces. The new adaptive clamping system uses a pneumatic chuck with force-controlled jaws corresponding to the air-controlled pressure, combined with a visual pattern recognition device enabling repositioning of the workpiece to ensure high positioning repeatability when re-clamping and during machining operations. The developed visual method for position recognition includes special and unique algorithms for position assignment and controlled motion of the machine table to provide accuracy and repeatability of  $\pm 1 \mu\text{m}$ . The x and y motions are combined with table rotation and can use the method and inclination device for the z axis positioning [1] and z motion of the cutting tool.

## 2 The Developed Position and Force-Controlled Clamping System

### 2.1 Features and Functions

The high-precision system is designed to enable clamping and re-clamping with very accurate positioning of up to  $\pm 1 \mu\text{m}$ . It is essential to adjust the clamping force to avoid deflections and deformations of the workpiece. The workpiece position after the first clamping is identified and measured using a high-precision vision device with a CCD camera. Force and position data are collected and analyzed for calculating the repositioning and the motion of the machine's  $x$  and  $y$  axes. Once the workpiece has been removed and re-clamped with the defined forces, the vision device identifies the new workpiece position. The difference between the measured position after re-clamping and the reference position is calculated, yielding the motion command to the  $x$ ,  $y$ , and rotation axes.

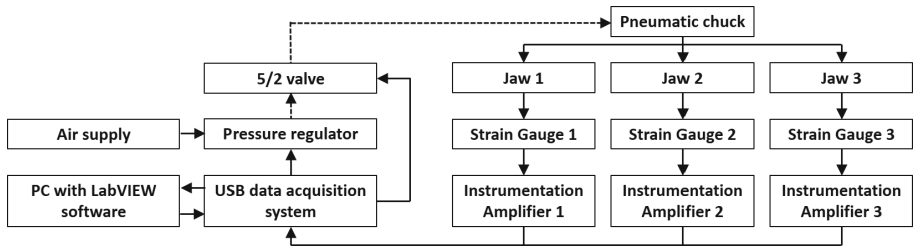


**Fig. 1.** The high-precision clamping system, (a) Experimental set-up for force measurement and force control, (b) Pneumatic chuck with three jaws equipped with strain gauges, (c) Clamping system on the machine tool with the vision set-up.

Figure 1 shows the experimental set-up of the newly developed system with the pneumatic chuck, the vision set-up for position recognition, and the jaws with strain gauges for clamping forces measurement. The device is mounted onto a high-accuracy rotating table for angular positioning, which in turn is mounted on the highly accurate CNC machine tool table (Fig. 1 (c)).

### 2.2 Force and Pressure Control of Clamping Forces

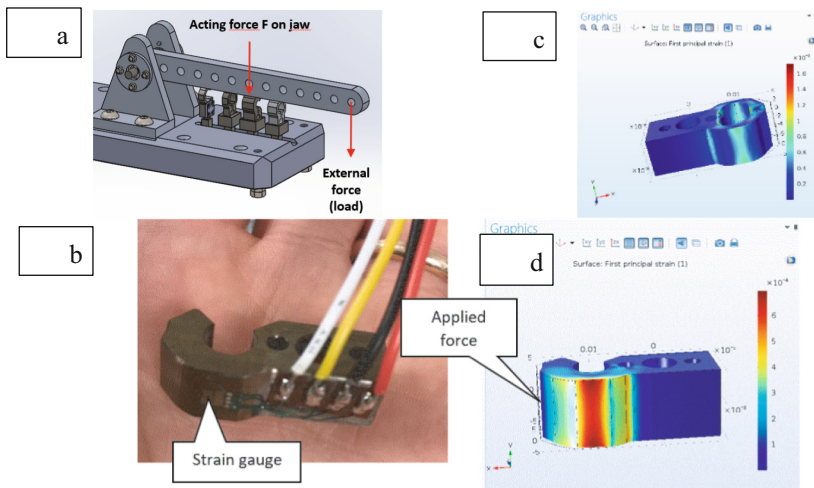
Figure 2 shows a block diagram depicting the architecture of the force and pressure-controlled pneumatic chuck. The high-precision clamping system enables adaptive workpiece holding and repositioning with force-controlled clamping jaws. The air pressure is supplied from an external source while controlling the pressure regulator and flow direction using a 5/2 valve (Fig. 1 (a)). The three jaws are equipped with strain gauges to control the clamping forces (Fig. 1 (b)). The force signals are transferred to a USB data acquisition system controlled by a PC with LabView Software. Based on the principle of identical pressure and clamping forces on all three jaws, it is sufficient to control the force on only one jaw in industrial applications. If the clamping force values are directly



**Fig. 2.** Block diagram of the pneumatic chuck with controlled clamping forces and air pressure.

proportional to the air pressure and can be used in a wider range, force control can be maintained.

The clamping forces for the three jaws with strain gauges are measured and controlled during the experiments. The jaws' design, material, and features should correspond with the range of the clamping forces, the workpiece properties, and the machining conditions. Different types and structures of jaws are designed and calibrated on the device shown in Fig. 3 (a). The deformation under variation of clamping forces is simulated using FEA (Fig. 3 (c) and 3 (d)). The jaws are equipped with force sensors to control the applied forces during clamping motion to secure minimum holding forces, avoid overloading, and secure clamping forces under machining conditions. The strain gauges are glued onto the zone with maximum deformation to obtain precise results and high resolution (Fig. 3 (b)). After preliminary tests with various materials (plastic, aluminum, steel), jaws made of steel are selected for testing the pneumatic chuck.



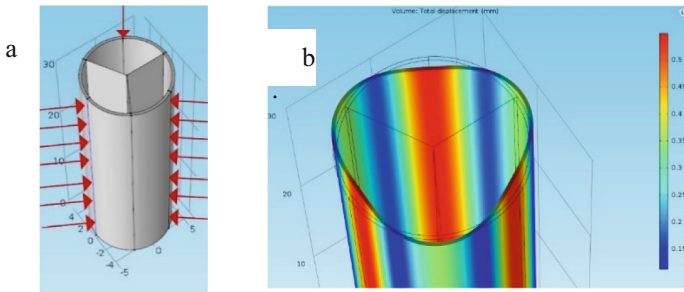
**Fig. 3.** (a) The force calibration device, (b) Steel jaws, with glued strain gauge, (c), Deformation of a closed profile jaw using FEA, (d) Deformation of an opened profile jaw using FEA.

The required gripping force range is  $F < 300$  N, evaluated using FEA of thin-walled tubes and low to medium cutting forces. The calculated and measured deformation with

closed profiles is too low compared to the opened profile. The tests are evaluated with 800 N and a maximum strain of  $600 \mu$ .

### 2.3 FEA of Thin-Walled Workpiece

The developed system is designed to eliminate overloads to limit or control the deformation of the workpiece. Strains and stresses over a certain value may result in plastic deformation and inaccuracies of the finished product. Machining when the component is under elastic deformations will result in inaccuracies of the finished component. Therefore, it is essential to minimize and control the clamping force. Figure 4 presents an example of an FEA model, calculating the maximum deformation of a 0.2 mm thin-walled aluminum tube. When using 300 N clamping force on each jaw, the maximum calculated deformation is 0.5 mm.

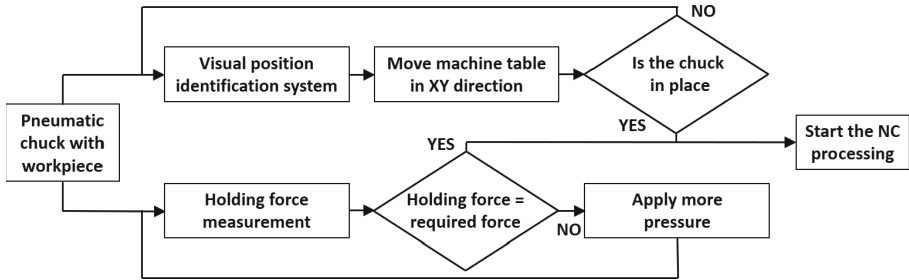


**Fig. 4.** Deformation of a cylindrical tube using FEA, (a) Clamping forces of the three jaws pneumatic chuck, (b) Calculated deformation of an aluminum tube using FEA.

### 2.4 Combination of Force Control, Vision Device and Motion Control Algorithm

The block diagram in Fig. 5 describes the workpiece movement procedure to the reference position, controlled by the vision device for position identification and by the clamping forces, using the high-precision CNC machine tool and an adjusted algorithm developed during this investigation.

The clamping system combines the pneumatic chuck for holding the workpiece within a defined holding force range and the visual position identification system for identifying the workpiece position and providing data to move and/or rotate the workpiece with the chuck in the x-y plane.



**Fig. 5.** Block diagram depicting the algorithm for visual position identification, moving the workpiece to the required position, and controlling clamping forces using the air pressure.

### 3 Test Procedure and Test Results

The selected jaws are calibrated with strain gauges at Braude College in Israel and with a force cell using a piezo-electric device at Fraunhofer IWU in Germany. The visual identification method is tested on the high-precision CNC machine tool with HV indentation marks. Investigations are carried out regarding the accuracy and repeatability of workpiece position, combined with the vision system, and the correlation between air pressure and clamping forces.

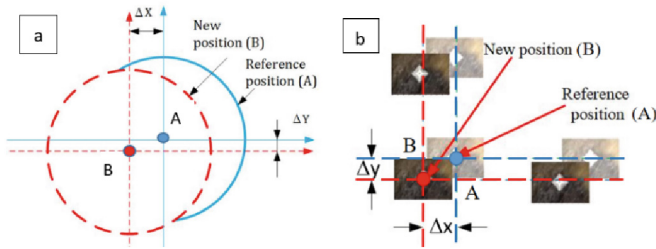
#### 3.1 The Vision Device for Position Recognition and Repositioning

The vision device has a very high resolution of  $0.002 \mu\text{m}$  in the  $x$  and  $y$  direction,  $0.05 \mu\text{m}$  in the  $z$  direction, and a resulting repeatability of  $0.1 \mu\text{m}$ .

The digital CCD image of the three indentations on the clamped demonstrator identified and presented the pattern location in  $x$ ,  $y$ , and  $z$  coordinates with a pixel resolution of  $1 \mu\text{m}$ . A subpixel resolution of the pattern recognition uses the light intensity with 8-bit information for a position accuracy of  $0.1 \mu\text{m}$ . The camera for pattern identification of the HV pattern center point uses image contrast information, depending on the illumination and surface reflection in confocal microscopy.

Preliminary testing of the vision recognition device, its accuracy, and repeatability are carried out on a demonstrator equipped with three HV (Hardness Vickers) indentations. Figure 6 shows the patterns of the three HV indented marks, the reference position A and the new position B after re-clamping ( $\Delta x$  and  $\Delta y$ ). The position identification after re-clamping is used to calculate the required machine tool movement relative to the reference point. After repositioning the reference point, the workpiece with the chuck can rotate to ensure the repositioning of the additional two points. The center points of the indentation patterns in the optical coordinates are transferred to the coordinate corrective values in the  $x$  and  $y$  directions and to the motion axes drives. Finally, the pattern center point of the new position is moved to the reference point using the  $x$  and  $y$  axes of the machine coordinate system. The complex position identification is characterized by a very high repeatability of less than  $1 \mu\text{m}$  for pattern identification.

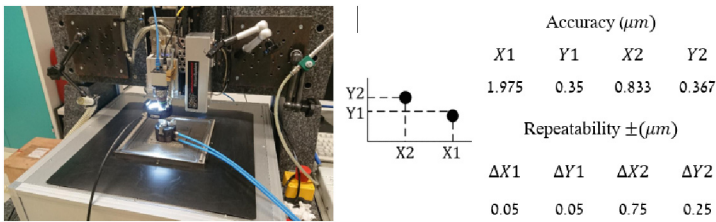




**Fig. 6.** (a) Motion of the demonstrator from the reference (blue lines) position to the new position, (b) Identifying the new and reference positions with three HV indentations.

**3.2 Accuracy and Repeatability of the CNC Machine Tool**

Tests are carried out on the CNC machine tool without re-clamping the workpiece to define the accuracy and repeatability of the new clamping device. Figure 7 (a) shows the tested high-precision machine developed at Fraunhofer IWU with the pneumatic chuck and the CCD camera. Figure 7 (b) presents an example of the accuracy and repeatability of two points (1, 2). The machine tool is moved a few times from the (0:0) position, measured with the vision system, and back to the reference position. The accuracy values are high, mostly <math>< 1 \mu\text{m}</math>, with few exceptions, and the repeatability values are very high, <math>< 1 \mu\text{m}</math>.



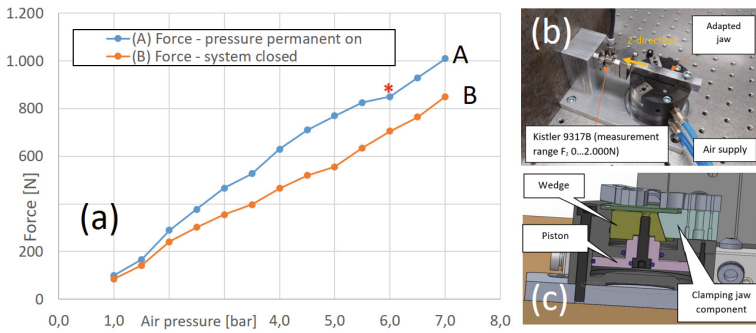
**Fig. 7.** (a) The high-precision CNC machine with the pneumatic chuck, (b) Accuracy and repeatability results.

**3.3 Force Measurements with a Kistler Device as a Function of Air Pressure**

The investigations are carried out on the pneumatic clamping chuck with simultaneously moving jaws. The tests checked the correlation between the air pressure and the clamping force. In this case, it is sufficient to measure the clamping force on one of the jaws. Figure 8 (b) shows the measurement set-up using a Kistler 9317B. The air supply inlet pressure varies from 1.0 to 7.0 bar.

Three repetitions are performed for every pressure step showing a constant increase with the pressure (Fig. 8 (a)). The blue line A is measured with permanent pressure without stopping the pump; the red line B illustrates force values measured after stopping the pump but without releasing the pressure, which means that the clamping forces are

reduced by approx. 10%. When decreasing the inlet air pressure, the clamping forces will not drop immediately due to the chuck's design and friction conditions.



**Fig. 8.** (a) Forces as a function of air pressure level (\*identical to manufacturer's specification). (b) Force measurement set-up for a single jaw. (c) The pneumatic chuck with central piston and wedge acting on the three jaws.

Figure 8 (c) demonstrates the area between the wedge and the three clamping jaws influencing the friction forces; thus, the clamping forces are also influenced. After clamping, these friction forces eliminate the immediate release of the jaws with decreasing air pressure. Therefore, the air inlet pressure can only be used as a clamping force sensor during increasing air pressure but is limited as a parameter during pressure release. Using a force measurement on one jaw can provide higher accuracy and should be preferred.

## 4 Conclusions and Further Developments

This paper presents a new adaptable clamping system for controlled high-precision positioning and repositioning of a workpiece in the x-y plane with visual pattern recognition, adjustment, and controlled clamping forces. Reproducible position correction and clamping of workpieces with a pneumatic chuck were investigated, evaluated, and combined, forming the new adaptive workpiece clamping device to ensure high positioning repeatability during re-clamping operations, and different machining processes.

The clamping device's position corrections and force control are based on a vision system and accurate force control. The design of the associated jaws is based on FEA to ensure workpiece holding, limited forces, and limited deformations. The visual pattern recognition is tested with a pneumatic clamping chuck on a high-precision CNC machine tool, providing very high accuracy and excellent repeatability. The authors are currently developing a new device with three piezo-electric motors for micro-machining with lower forces and very high accuracy.

**Acknowledgment.** This research project was performed under the EUREKA program, supported by the Israeli Innovation Authority, project number 59410, and AiF GmbH for BMWi Project funding SmartClamp by ZIM Project ZF4016224AT7.

## References

1. Ben-Hanan, U., et al.: Lecture, Position controlled pneumatic chuck for high precision machining, Euspen (2021)
2. Denkena, B., Dahlmann, D., Kiesner, J.: Production monitoring based on sensing clamping elements. *Procedia Technol.* **26**, 235–244 (2016)
3. Jantzen, S., et al.: Microclamping principles from the perspective of micrometrology—A review. *Precis. Eng.* **50**, 538–550 (2017)
4. Gross, S., Eckert, U., Edelmann, J.: New sequential manufacturing process for micro and finishing machining. *Procedia CIRP* **46**, 559–562 (2016)
5. Gameros, A., Lowth, S., Axinte, D., Nagy-Sochacki, A.: State-of-the art in fixture systems for the manufacture a component: a review. *Int. J. Mach. Tools Manuf* **123**(2017), 1–21 (2017)
6. Komi, E.R., Roberts, J.R., Rothberg, S.: Evaluation of thin, flexible sensors for time-resolved grip force measurement. *Proc. Inst. Mech. Eng. C J. Mech. Eng. Sci.* **221**(12), 1687–1699 (2007)
7. Azaria Udi – Catalogue & Manuel, Henri Azaria, PAL Ltd, Maker of PML, Tel Aviv, Israel
8. Wang, S.-M., Lin, J.-J.: On-machine volumetric-error measurement and compensation methods for micro machine tools. *Int. J. Precis. Eng. Manuf.* **14**(6), 989–994 (2013)
9. Schubert, A., Koriath, H.-J., Schneider, J., Blank, G.: Highest precision milling and process-adjusted drive control. In: 8th CIRP International Workshop on Modeling of Machining Operations, pp. 447–452 (2005)

**Open Access** This chapter is licensed under the terms of the Creative Commons Attribution 4.0 International License (<http://creativecommons.org/licenses/by/4.0/>), which permits use, sharing, adaptation, distribution and reproduction in any medium or format, as long as you give appropriate credit to the original author(s) and the source, provide a link to the Creative Commons license and indicate if changes were made.

The images or other third party material in this chapter are included in the chapter's Creative Commons license, unless indicated otherwise in a credit line to the material. If material is not included in the chapter's Creative Commons license and your intended use is not permitted by statutory regulation or exceeds the permitted use, you will need to obtain permission directly from the copyright holder.





# Initial Period of Chip Formation: Observations Towards Enhancing Machining Sustainability

Y. Alammari<sup>(✉)</sup>, J. Saelzer, S. Berger, I. Iovkov, and D. Biermann

Institute of Machining Technology, TU Dortmund University, Baroper Street 303,  
44227 Dortmund, Germany  
youssef.ammari@tu-dortmund.com

**Abstract.** In machining, high mechanical and thermal loads are exerted on a small area of the tool where it interacts with the workpiece. Despite limited interaction space, extensive use of cutting fluids (CFs) is inefficiently used to improve the machining process and increase productivity. In order to minimize CFs' negative impact on health, environment and financial burden, various strategies have been developed and studied to optimize their use including minimum quantity lubrication. In this research, initial period of chip formation (IPCF), that occurs during a narrow window of space and time at the beginning of the cut, is closely investigated in an orthogonal machining setup. During IPCF, low mechanical loads were observed. The existence of IPCF is further investigated under interrupted cutting process at prescribed intervals in order to sustain its positive effects. In addition, 2D numerical chip formation friction model is proposed. The numerical model comprises a friction criterion dependent on tool temperature that is observed to be associated with a transient friction regime.

**Keywords:** Initial period of chip formation · Interrupted machining · MQL · Simulation · Sustainability

## 1 Introduction

In processing materials by machining, cutting fluids (CFs) are commonly used to improve product quality and enhance productivity. CFs extensive use imposes increased risk to health and environment [1]. Therefore, eliminating or minimizing their application has been a subject for many researchers. Despite their limited requirement in time and space, superfluous volumes are being supplied, e.g. in flood strategy.

Dry machining can be the best way to sustain health and environment. However, it cannot be realized in many machining applications due to poor product quality outcomes, increased tool wear and reduced productivity. Therefore, rational consumption and optimization of CFs have been researched. For instance, minimum quantity lubrication (MQL) has been successful in many machining applications where very low consumption of CFs can be realized [2].

While it is important to observe the effectiveness of CFs for enhancing machinability in terms of machined surface quality and improved material removal rate, it is quite

essential to understand and fundamentally explore the physical and chemical limitations that bound their effectiveness. In particular, the theory of varying contact conditions within tool-chip interface (i.e., sticking and sliding zones) [3–5] can shed the light into better understanding where CFs can provide lubrication and/or cooling. High thermal and mechanical loads, which exist between tool and workpiece, work against proper CFs access to the contact areas where it is most needed. For instance, high normal and shear stresses, located close to the cutting edge, squeeze the lubricant film out of the contact area leaving it to as minimum as the average height of the asperities [6]. Moreover, high temperatures that may reach up to the melting point of the workpiece leave no chance for CFs to provide almost any lubrication action.

It has been observed that interrupted machining can enhance the machinability of low thermal conductivity materials such as stainless steels, titanium or nickel-base alloys (e.g. Inconel 718) [7, 8]. These difficult-to-cut materials require relatively low cutting speeds to avoid high temperatures caused by poor heat dissipation out of the tool-chip interface that is rather carried away with the removed chips. In continuous machining operations such as turning or drilling, the cutting tool is intimately engaged with the workpieces for long period of time. As a result, CFs' actions are restricted or even absent after a short distance of cutting. Lubricant effect supplied in pockets along the cutting path was investigated by Saelzer et al. [9]. Significant reduction in mechanical loads lasted a finite period of cutting time after exposure to the lubricant. Itoigawa et al. [6] investigated the effect of MQL in interrupted machining of an aluminum alloy where transient reduction of feed forces was observed at the beginning of cutting intervals. For efficient application of CFs, it is still necessary to fundamentally investigate the boundaries of interrupted machining characteristics in relation to machining setup and environment.

In this study, initial period of chip formation (IPCF), where low tool-chip contact may occur within a finite cutting length, is closely investigated in an orthogonal machining setup. Mechanical loads were observed and the existence of IPCF is further investigated under interrupted cutting process at different intervals. Moreover, 2D numerical chip formation model is proposed to better understand IPCF mechanisms.

## 2 Methodology

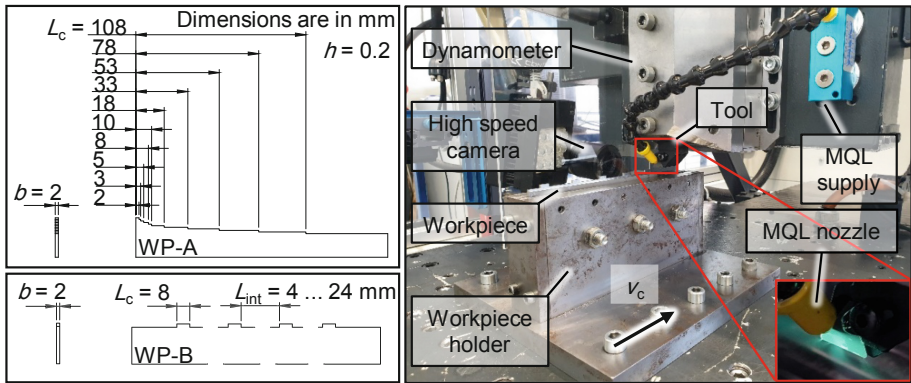
In order to investigate the contact condition at the start of the cut, stepped workpieces allowing for variable cutting lengths were prepared, as shown in Fig. 1. The evolution of contact as appears on the tool is examined. The total tool-chip contact length  $l_c$  on the rake face of the tool was measured until the end of adhesion marks taking into account the development of sticking and sliding zones that appear progressively on the rake face. Moreover, slotted workpieces were prepared to investigate the influence of interrupted cutting on sustaining IPCF. IPCF effect was modelled using 2D chip formation simulations with modified friction model.

### 2.1 Tools and Materials

The machine tool used was a custom-built CNC machine that allows fundamental analysis of chip formation in orthogonal cutting, see Fig. 2. A three-axis piezoelectric

dynamometer type 9263 (Kistler AG) was used to monitor process forces during machining. Synthetic MQL oil Vascomill MMS HD 1 (Blaser Swisslube AG) was applied on the rake face using air brush prior to the cutting occurrence during continuous cut and supplied as MQL during interrupted cutting trials. Optical microscope VHX5000 (Keyence GmbH) was used for taking rake images and quantifying tool-chip contact zones.

As workpiece material, austenitic stainless-steel alloy X8CrNiS18-9 (1.4305) was used. The specimens were separated from a round workpiece, using waterjet machining. The workpieces had a width of  $b = 2$  mm. Stepped workpiece (WP-A) with cutting lengths  $L_c = 2 \dots 108$  mm were prepared. Additionally, slotted workpieces (WP-B) were prepared with cutting length  $L_c = 8$  mm and different interruption lengths  $L_{int} = 4 \dots 24$  mm.



**Fig. 1.** Workpieces geometry (left) and experimental Setup (right)

Tool holder CTFPL2525M16 with uncoated tungsten carbide (WC) inserts TPGN160308H13A from manufacturer Sandvik were used. The cutting insert has a triangular shape with cutting edge radius measured at  $r_\beta = 8 \mu\text{m}$ . Uncut chip thickness was kept constant for all trials at  $h = 0.2$  mm, as well as the rake angle of  $\gamma_0 = 6^\circ$  and the clearance angle of  $\alpha_0 = 5^\circ$ . The cutting speed was varied in the range of  $v_c = 30, 60$  and  $90$  m/min.

## 2.2 2D Chip Formation Simulations

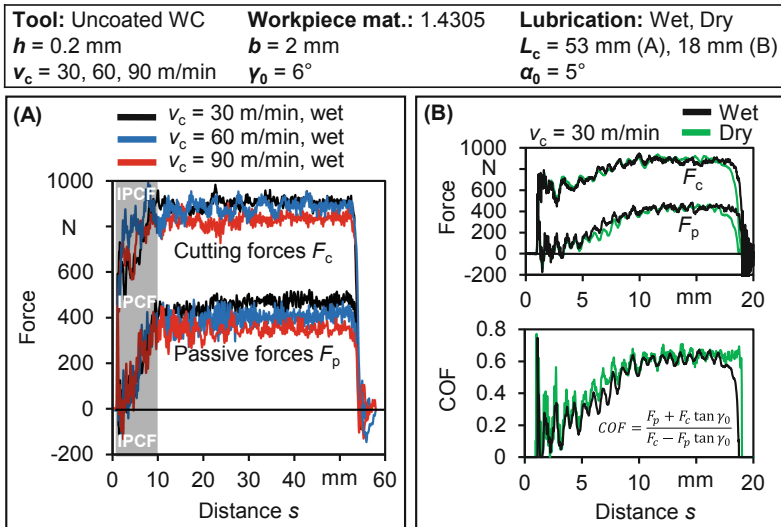
Two-dimensional (2D) numerical chip formation simulations were carried out using DEFORM 2D V12.0. Adaptive meshing was provided in both bodies to enable an efficient calculation and the detailed resolution of the effective zones. Minimum element size was set at  $6 \mu\text{m}$  and the maximum element size was set at  $50 \mu\text{m}$ . For the flow stress modeling, a Johnson and Cook model was used, see Fig. 5. Model parameters were obtained from Lee et al. [10] for comparable stainless-steel alloy AISI 304. For simulating serrated chips, a Cockcroft-Latham damage criterion was considered to have a critical value at 150 and the flow stress reduces to 35% of the original flow stress value. Tool thermal conductivity was a function of temperature according to Vornberger et al. [11].

Tool-workpiece friction was modeled as hybrid friction, where the friction is considered as shear friction within sticking zone and as Coulomb friction within sliding zone. Coulomb friction coefficient varies between two values depending on tool temperature. The maximum and minimum values were selected at  $\mu_{\min} = 0.15$  and  $\mu_{\max} = 0.5$  analogues to dry and lubricated conditions, respectively. The transition temperature was set at  $T_{\text{crit.oil}} = 200$  °C corresponding to lubricant flash point according to manufacturer literature. In the simulation, the friction occurs in element level. Hence, the increase in overall friction changes gradually to a plateau when the temperature of tool elements in-contact exceeds  $T_{\text{crit.oil}}$ .

### 3 Results and Discussions

#### 3.1 Initial Chip Formation and Correlated Low Tool-Chip Contact

Chip formation undergoes complex physical evolution during machining process. In particular, at the start of the cutting interval, a transient behavior appears to exhibit an interesting behavior where low mechanical loads can be observed. It is quite important to understand how such development occurs, its limiting criteria and influencing factors. Figure 2 shows mechanical loads and calculated coefficient of friction during orthogonal cutting.

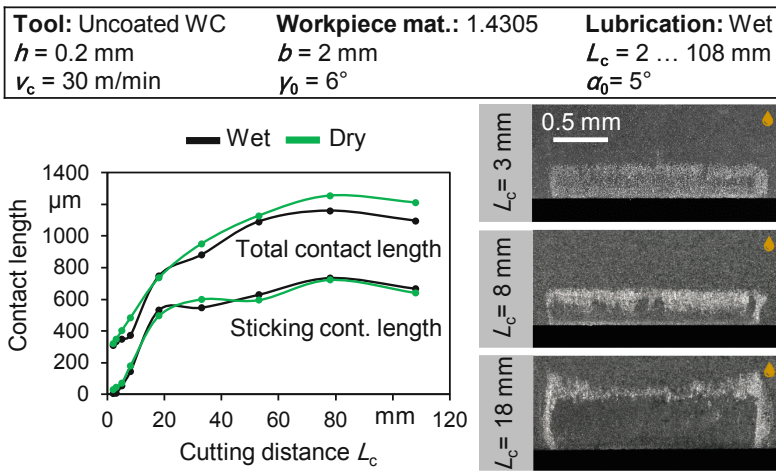


**Fig. 2.** Mechanical loads during IPCF (A) using different speeds (B) Mechanical loads at  $L_c = 18$  mm and  $v_c = 30$  m/min and calculated coefficient of friction (COF)

The passive force  $F_p$  is affected to large extent by the friction in the secondary shear zone where the rake side of the tool contacts the forming chip. Contaminants (e.g. lubricants and oxides) and tool surface characteristics such as roughness and coatings are main factors that determine contact behavior within tool-chip interface.

When observing mechanical loads at IPCF, low forces were detected with more reduction associated with the passive force  $F_p$ . The reduction in measured forces occurs only at the beginning of the cut. The transient region appears to reach a plateau at specific cutting length irrespective of the cutting speed. This observation may indicate possible temperature-related phenomenon that promotes adhesion and severe friction.

To investigate the history of the contact during IPCF, adhesion on the rake face resulting after machining different cutting lengths was examined. An area of intimate contact that is located towards the cutting edge, where no adhesion marks, is considered as the sticking zone while the region with adhesion marks is considered the sliding zone. Figure 3 summarizes measured contact lengths.



**Fig. 3.** Tool-chip contact zones measured as appears on tool's rake face

The sticking zone develops gradually as cutting progress reaching a stable value after some cutting length. Qualitatively, the development of sticking area is analogous to observations related to cutting forces. The full contact might have been delayed by contaminants that exist during initial chip formation.

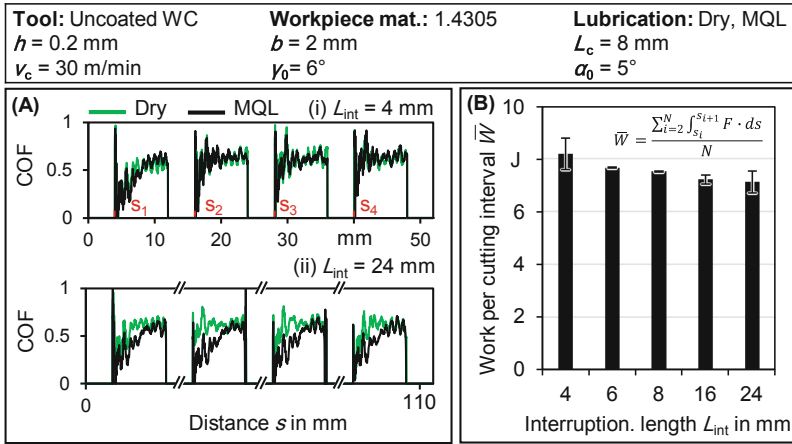
IPCF appears to result lower mechanical load and lower chip-tool contact. However, to this point, IPCF analysis has been applied to single cutting occasion. Since the effects of IPCF are temporary, the goal is to maintain the favorable effects through interrupting the cutting process.

### 3.2 Interrupted Machining

As can be noticed from previous section, the effects associated with IPCF are transient and cannot be sustained after finite cutting distance. Therefore, interrupted cutting can offer an opportunity to sustain the favorable effects associated with IPCF. During cutting interruption, spatial and temporal windows can offer a potential to cool the tool down and restore contamination layer (e.g. lubricant film).



Cutting length was fixed, to be within IPCF range, at  $L_c = 8$  mm. Interruption length  $L_{int}$  was varied within range  $L_{int} = 4 \dots 24$  mm. Each workpiece has a constant interruption length  $L_{int}$ . Figure 4 (A) illustrates calculated COF  $= (F_p + F_c \tan\gamma_0)/(F_c - F_p \tan\gamma_0)$  of four consecutive cutting intervals for two outermost cases at  $L_{int} = 4$  and  $L_{int} = 24$  mm. The average work of single cutting intervals  $\bar{W}$  after the first interruption of different interruption lengths was calculated and summarized in Fig. 4 (B).



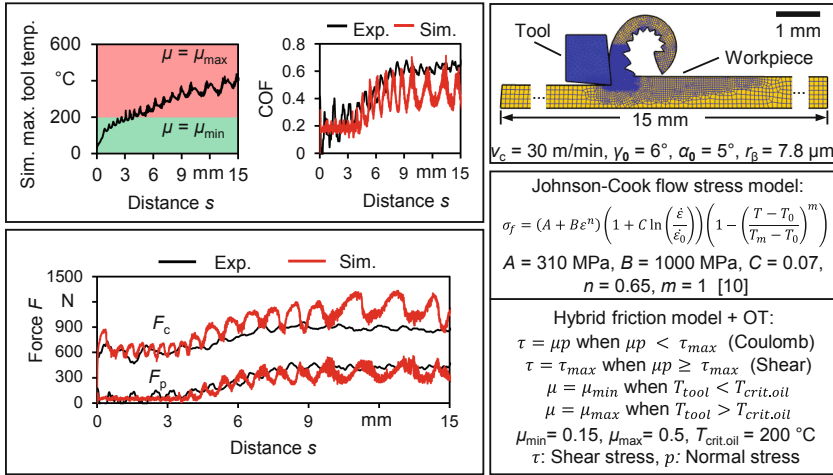
**Fig. 4.** Interrupted cutting under MQL with varying interruption length

Interruption can be rather important for sustaining the effects of IPCF. At short interruption length limited chance is available to clear the chips, cool down the tool and restore contamination layer. On the other hand, as interruption duration increases by means of interruption length, subsequent cutting intervals exhibit repeatable behavior comparable to the first cutting interval. Average work per cutting interval continues to decrease as interruption length increases in a direct correlation to interruption effectiveness. It is still important to investigate which physical characteristics contribute the most into IPCF. Hence, 2D chip formation model is proposed in the next section.

### 3.3 2D Chip Formation Simulations

2D chip formation finite element (FE) simulation model is proposed consisting of a modified hybrid friction model that includes a transition friction coefficient as a function of tool temperature  $T_{tool}$ . The transition temperature was selected to be lubricant flash point at  $T_{crit.oil} = 200$  °C. Selected simulation parameters, force, COF and maximum simulated tool temperature are shown in Fig. 5.

The modified friction model was able to reveal a transition range, characterized by passive force, representing initial chip formation that is very close to experimental results. In simulation, total tool-chip contact was 0.28 mm and 0.50 mm at 2 mm and 10 mm cutting distance, respectively, which are within comparable magnitude to experimental results shown in Fig. 2.



**Fig. 5.** IPCF 2D FE chip formation simulation with oil temperature (OT) friction criterion

However, there were issues concerning force levels. On average, the cutting force appeared 20% higher and the passive force was 12% lower. A possible cause might be related to fundamental limitations of Johnson-Cook flow stress model at high temperatures in combination with high strain rates [12]. Also, force fluctuation range due to serrated chip formation both at low and high friction regimes appeared different than experimental results. That could be attributed to tool-workpiece dynamics that were not included in the present model. Improvements about flow stress model and system dynamics are still required to achieve better simulations results.

## 4 Conclusion

Initial period of chip formation (IPCF), which occurs at the start of the cutting process, was observed to exhibit reduction in mechanical load and low tool-chip contact in comparison with steady state condition. Characterization of IPCF can be beneficial for improving continuous machining processes by introducing interruptions along the cutting path. Cutting fluids (CFs) working action can be improved during IPCF leading to targeted and efficient CFs application and improved sustainability.

The present investigations indicate a finite cutting length where transient IPCF effects do exist before diminishing at steady state. In order to maintain IPCF, adequate cutting-free period is required. There seems to be a relationship between adhesion on the rake face of the tool and the end of IPCF. The sticking contact appears to develop gradually within IPCF until it reaches a final size. This delay indicates an apparent relationship between contaminants resistant to ablation and mechanical loads. Enhanced performance of MQL under interrupted cutting within IPCF was observed. The repeatability of IPCF is affected by interruption size. IPCF appears to be insensitive to cutting speed and a finite cutting length can be identified. The proposed modification in the friction model in FE simulations was capable of producing a transition period analogue to IPCF.

More investigations are required to study IPCF of different materials particularly with different thermal properties. Opportunities exist for improvements about IPCF modeling considering tool-workpiece dynamics and enhancing flow stress and friction models.

**Acknowledgements.** The authors would like to thankfully appreciate the financial support from Qassim University in Saudi Arabia provided as a PhD scholarship.

## References

1. Fernando, W.L.R., Karunathilake, H.P., Gamage, J.R.: Strategies to reduce energy and metal-working fluid consumption for the sustainability of turning operation: a review. *Cleaner Eng. Technol.* **3**, 100100 (2021)
2. Weinert, K., Inasaki, I., Sutherland, J.W., Wakabayashi, T.: Dry machining and minimum quantity lubrication. *CIRP Ann.* **53**, 511–537 (2004)
3. Finnie, I., Shaw, M.C.: The friction process in metal cutting. *Trans. Am. Soc. Mech. Eng.* **78**, 1649–1653 (1956)
4. Trent, E.M.: Metal cutting and the tribology of seizure: i seizure in metal cutting. *Wear* **128**, 29–45 (1988)
5. Childs, T.H.C.: Friction modelling in metal cutting. *Wear* **260**, 310–318 (2006)
6. Itoigawa, F., Takeuchi, D., Nakamura, T., Childs, T.H.C.: Experimental study on lubrication mechanism in MQL intermittent cutting process. *Mach. Sci. Technol.* **11**, 355–365 (2007)
7. Karaguzel, U., Olgun, U., Uysal, E., Budak, E., Bakkal, M.: Increasing tool life in machining of difficult-to-cut materials using nonconventional turning processes. *The Int. J. Adv. Manuf. Technol.* **77**(9–12), 1993–2004 (2014)
8. Alammari, Y., Iovkov, I., Saelzer, J., Wolf, T., Biermann, D.: Adhesion of inconel 718 on uncoated tungsten carbide inserts in interrupted orthogonal machining under MQL. *Procedia CIRP* **103**, 194–199 (2021)
9. Saelzer, J., Alammari, Y., Zabel, A., Biermann, D., Lee, J., Elgeti, S.: Characterisation and modelling of friction depending on the tool topography and the intermediate medium. *Procedia CIRP* **102**, 435–440 (2021)
10. Lee, S., Barthelat, F., Hutchinson, J.W., Espinosa, H.D.: Dynamic failure of metallic pyramidal truss core materials—experiments and modeling. *Int. J. Plast* **22**, 2118–2145 (2006)
11. Vornberger, A., et al.: Influence of cemented carbide composition on cutting temperatures and corresponding hot hardnesses. *Materials* **13**, 4571 (2020)
12. Warnecke, G., Oh, J.-D.: A new thermo-viscoplastic material model for finite-element-analysis of the chip formation process. *CIRP Ann.* **51**, 79–82 (2002)

**Open Access** This chapter is licensed under the terms of the Creative Commons Attribution 4.0 International License (<http://creativecommons.org/licenses/by/4.0/>), which permits use, sharing, adaptation, distribution and reproduction in any medium or format, as long as you give appropriate credit to the original author(s) and the source, provide a link to the Creative Commons license and indicate if changes were made.

The images or other third party material in this chapter are included in the chapter's Creative Commons license, unless indicated otherwise in a credit line to the material. If material is not included in the chapter's Creative Commons license and your intended use is not permitted by statutory regulation or exceeds the permitted use, you will need to obtain permission directly from the copyright holder.





# Influence of Carbon Dioxide Temperature on Sprayability and Solubility in Cryogenic Minimum Quantity Lubrication with Bio-Based Lubricants

Trixi Meier<sup>(✉)</sup>, Michael Lermer, Daniel Gross, and Nico Hanenkamp

Institute of Resource and Energy Efficient Production Systems (REP),  
Friedrich-Alexander-Universität Erlangen-Nürnberg, Dr.-Mack-Str. 81 | Technikum 1, 90762  
Fürth, Germany  
trixi.meier@fau.de

**Abstract.** Cryogenic minimum quantity lubrication (CMQL) represents a compromise satisfying both efficiency and sustainability in many manufacturing processes. In previous series of experiments a variation of the thermodynamic state of the cryogenic medium taken from riser bottles could be observed. Consequently, the aim of this study was to specifically control the thermodynamic state of the CO<sub>2</sub> and, associated with this, the density after removal from the riser bottles. To achieve this objective conventional cooling was implemented for the CO<sub>2</sub> after withdrawal from the riser bundle in order to have a constant liquid state of the CO<sub>2</sub> during feeding. The density of the cryogenic medium could be raised from  $\rho = 550 \text{ kg/m}^3$  to over  $800 \text{ kg/m}^3$  at a mass flow rate of  $\dot{m}_{CO_2} = 5 \text{ kg/h}$  with the applied cooling method and can also be stabilized regarding the density pulsation. Subsequently, the effects of temperature-controlled CO<sub>2</sub> on the sprayability and solubility in CMQL were examined and resulted in increased atomization of the oils and widening of the spray corridor with a greater main spray length and intensity. In addition stable conditions for the CMQL-supply to the manufacturing process were achieved by a lower pulsation of the CO<sub>2</sub>-oil mixture.

**Keywords:** CMQL · Liquid carbon dioxide · Bio-based lubricants

## 1 Introduction

Continuous development of cooling lubricants and cooling lubrication strategies is necessary in order to be able to meet the growing requirements for the machining of high-temperature materials and alloys in the future. In addition, the goal of sustainable design of manufacturing processes must be pursued. Based on these requirements, cryogenic minimum quantity lubrication (CMQL) has been developed in recent years. To investigate the properties of the two media CO<sub>2</sub> and oil during the joint feed to the tool cutting edge, selected lubricant experiments are carried out to investigate the influence of temperature-controlled carbon dioxide on sprayability and solubility in CMQL. A conventional cooling is implemented for the CO<sub>2</sub> after withdrawal from the riser bundle in order to guarantee a constant liquid state of the medium during the supply.

© The Author(s) 2023

H. Kohl et al. (Eds.): GCSM 2022, LNME, pp. 202–210, 2023.

[https://doi.org/10.1007/978-3-031-28839-5\\_23](https://doi.org/10.1007/978-3-031-28839-5_23)

## 2 State of the Art

In this chapter, the bio-based CMQL and the physical and chemical properties of CO<sub>2</sub> are explained in more detail.

### 2.1 Cryogenic Minimum Quantity Lubrication with Bio-Based Oils

In CMQL, a minimal amount of oil is added to the cryogenic medium (liquid CO<sub>2</sub> (LCO<sub>2</sub>) or liquid nitrogen (LN<sub>2</sub>)) to ensure sufficient lubrication in addition to cooling of the contact zone. Thus, the advantages of the two cooling lubrication strategies MQC and cryogenic cooling can be used synergetically. The CMQL-supply can be divided into an external supply to the machining zone or an internal supply through the machine spindle and tool. Furthermore, the two media can be fed separately using a so-called two-channel solution or as a mixture in a one-channel system. The solubility and flow characteristics of a multiphase mixture do not have to be taken into account when the media are supplied separately. In addition bio-based oils can be used to increase the sustainability of the CMQL. A bio-based lubricant can be declared as such, if its proportion of renewable raw materials is at least 25 percent and its degradability is more than 60 percent. Triglycerides can be cited as examples of bio-based lubricants. These are esterified glycerol to which three fatty acids are bound. The configuration of the fatty acids and their state of saturation determine the chemical and physical properties of the lubricant. [1].

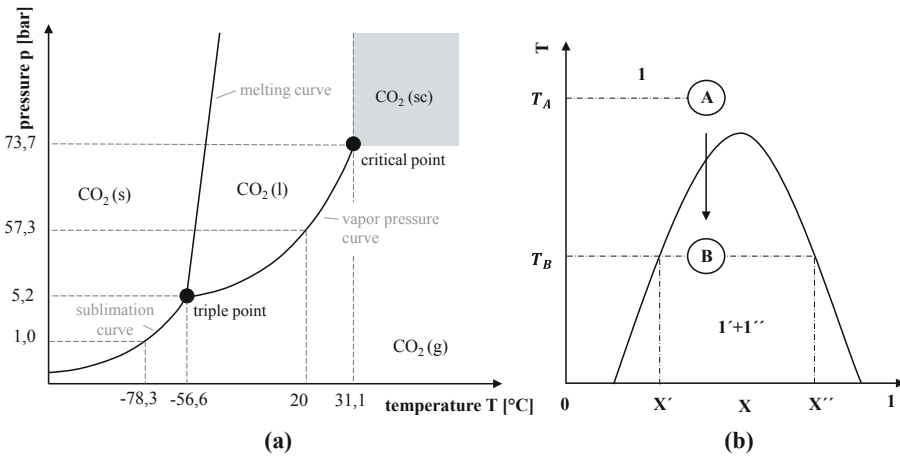
A one-channel CMQL system was developed in 2015 at the REP-chair [2]. Extensive research on the use of bio-based oils for CMQL has already been carried out with this system. The influence of fatty alcohols, mineral oils, synthetic and natural esters on the milling of Ti6Al4V compared to conventional flood cooling resulted in the highest tool life when using and natural esters with CMQL [3]. Further investigations on the influence of bio-based base oils and additive oils on the solubility and sprayability and on drilling, milling and turning of stainless steel and roller bearing steel confirm the high potential using natural esters for CMQL compared to conventional flood cooling with regard to longer tool life and reduction of wear and forces [4, 5]. This results in economic and ecological advantages, while increasing the process efficiency.

### 2.2 Properties of Carbon Dioxide

Carbon dioxide exists in four states: solid (s), liquid (l), gaseous (g) and supercritical (sc), see p-T diagram in Fig. 1a. At the triple point, the three phases (s, l and g) are in thermodynamic equilibrium. At ambient pressure (1.013 bar), the temperature of CO<sub>2</sub> is  $T = -78.5\text{ }^{\circ}\text{C}$ . In this state, CO<sub>2</sub> exists in a solid aggregate and is known as dry ice. In the range of these pressure and temperature regions, solid CO<sub>2</sub> changes directly into the gaseous phase during phase transformation and sublimates afterwards. Several scientific studies have already dealt with the thermodynamic processes during cryogenic cooling. Krämer investigated the thermodynamic process of carbon dioxide within the feed and the nozzle and Pursell investigated the exit mechanism of carbon dioxide after the nozzle in more detail, defining the mechanisms that occur [6, 7]. Since the cooling effect of CO<sub>2</sub> is primarily generated by the sublimation of solid into gaseous phase, too high proportion of gaseous CO<sub>2</sub> can reduce the cooling effect. Another cooling effect occurs

immediately after exiting the nozzle. This phenomenon is known as the Joule-Thomson effect. According to this, a throttled pressurized gas expands once it has left the nozzle, losing additional temperature in the process [8].

When assessing the solubility of two substances, the principle “like dissolves in like” often applies. This refers to interactions between molecules, which are described with the aid of the polarity of a substance. In general, a mixture is understood as a substance formed from two pure substances. In a heterogeneous mixture, the two substances are in separate phases (multiphase), and in a homogeneous mixture, the two media have mixed completely at the molecular level and the state corresponds to a single-phase aggregate state. The physical properties of the mixture are determined by the respective proportions of the mixed media.



**Fig. 1.** a. CO<sub>2</sub>: p-T diagramm. b. T-x diagramm (right).

Depending on the thermodynamic state the variables pressure, temperature or volume, and the composition of the mixture can change. This is usually represented in a T-x diagram, where the temperature T is plotted against the proportion x of the mixture partners involved. The value range of the diagram is divided into the states heterogeneous and homogeneous mixture, for example, with the aid of a parabolic line. With a T-x diagram, it is now possible to determine, those mixture configurations consisting of temperature T and substance fractions x in which either complete mixing (1) is possible or two separate phases (1' + 1'') occur. The area enclosed by the segregation curve is therefore also referred to as the mixing gap. Figure 1b shows, for example, a change in state of a mixture from A to B when the temperature is lowered. In this case, state A describes a homogeneous mixture, and if the temperature is lowered from T<sub>A</sub> to T<sub>B</sub>, the phases separate when the area enclosed by the segregation curve is reached.

The aim of this investigation is to influence the thermodynamic conditions in order to be able to realize a process-safe and thus low-pulsation feed of the CO<sub>2</sub>-oil mixture into the process zone which is more independent of the initial state of the CO<sub>2</sub>, e.g. with

regard to fluctuating densities. Furthermore, the influence on sprayability and solubility will be investigated as a process property of CMQL for machining.

### 3 Experimental Setup

In this chapter, the experimental boundary conditions are considered. The cryogenic mixing system with temperature-controlled carbon dioxide through pre-cooling, the oils investigated and the setup for the sprayability and solubility tests are explained.

#### 3.1 Cryogenic Mixing System with Temperature-controlled Carbon Dioxide

The temperature and pressure conditions during the feed of the two media illustrate the changes of the  $\text{CO}_2$  aggregate state within the CMQL-system developed at the REP chair [2], see Fig. 2. The system consists of an HPLC-pump, a coriolis sensor and an oil reservoir. The  $\text{CO}_2$  taken from the riser bottles is pre-compressed at  $T = 20\text{ }^\circ\text{C}$  with a pressure of  $p = 50.37\text{ bar}$ . The  $\text{CO}_2$  remains in this state until it enters the nozzle (1). Inside the nozzle (2), the atmospheric pressure outside the nozzle causes a pressure equalization. The pressure drops to  $p = 5.18\text{ bar}$ , at a temperature of  $T = -56.6\text{ }^\circ\text{C}$ . At the triple point the  $\text{CO}_2$  is present in the three aggregate states: gaseous, liquid and solid. At the nozzle outlet (3) prevails directly atmospheric pressure of  $p = 1.013\text{ bar}$ . The  $\text{CO}_2$  reaches its minimum temperature of  $T = -78.5\text{ }^\circ\text{C}$  and dry ice is formed, which sublimates as it equals the ambient temperature.

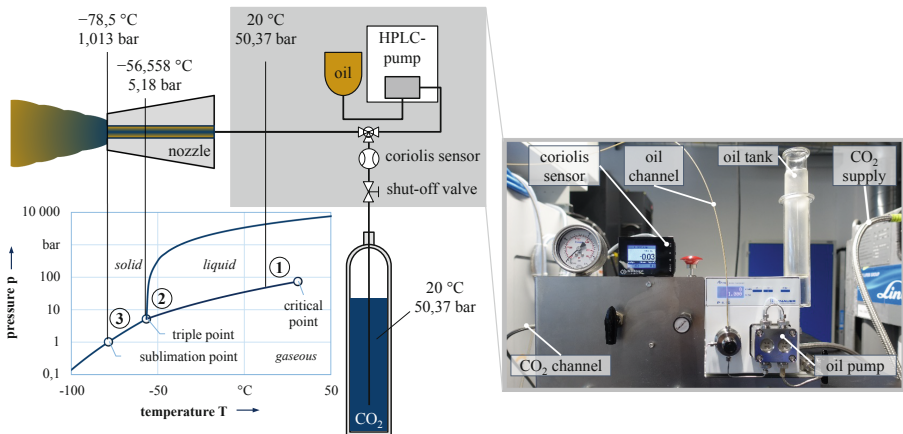


Fig. 2. Cryogenic mixing system REP chair [9]

For a safe application of the system with low pulsation, the  $\text{CO}_2$  must be in a stable liquid state at the system inlet. Changes in ambient conditions, e.g. lower temperature, low  $\text{CO}_2$  level or defects in the riser bottles, can lead to an increasing gas phase ratio and a lower  $\text{CO}_2$  density. A pre-study was carried out at the chair to increase the density by cooling the  $\text{CO}_2$  supply line. Figure 3a describes the experimental setup where cooling



is achieved by means of a cooling circuit in which a water tank ( $V = 50$  l) is cooled to a constant temperature of  $T = 4$  °C and the  $\text{CO}_2$  is fed through a pipe with a length of  $l = 6.5$  m. The aim of  $\text{CO}_2$  cooling is to maximize the liquid ratio of  $\text{CO}_2$  arriving at the mixing valve of the one-channel CMQL system. Since the cooling effect of the  $\text{CO}_2$  is primarily generated by sublimation, this can be optimized by subsequent liquification of the  $\text{CO}_2$  in the feed. The  $\text{CO}_2$ -temperature (with a mass flow rate of  $\dot{m}_{\text{CO}_2} = 5$  kg/m) was reduced from  $T = 21$  °C to  $T = 14.84$  °C and the density was increased from  $550$  kg/m<sup>3</sup> to over  $800$  kg/m<sup>3</sup>. The thermodynamic relationships are explained using the T-s diagram, see Fig. 3b. Initial state 1 ( $T = 21$  °C,  $p = 57.3$  bar,  $\rho = 500$  kg/m<sup>3</sup>) characterizes the  $\text{CO}_2$  as it exits the bundle and describes a state within the wet steam region. If a cooling effect is exerted on the  $\text{CO}_2$  at constant pressure, the density increases as the temperature decreases (state 2). This causes a shift of the  $\text{CO}_2$  state to the boiling line, and a stable liquid state is achieved.

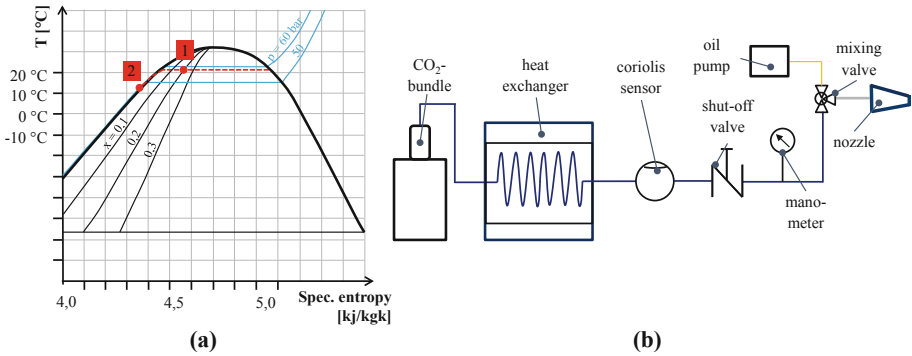


Fig. 3. a. T-s diagram  $\text{CO}_2$ . b. experimental setup.

### 3.2 Base Oils

In previous test series, it was shown that the properties of the base oil are decisive for the mixing and spraying behavior in CMQL. The three base are hydrocarbons, natural esters and synthetic esters. The chemical structure and RRM content is shown in Table 1.

Table 1. Examined oils

name	chemical structure	RRM content (Renewable Rawmaterial)
KW 01	renewable	75 – 99 %
NE 03	triglyceride	100 %
SE 09	monoester	>50 %

KW: natural hydrocarbon; NE: natural ester; SE: synthetic ester

### 3.3 Dynamic Solubility and Spray Pattern Tests

The solubility processes during the single-channel feed of the two media oil and CO<sub>2</sub> can be investigated with the aid of a high-pressure viewing cell. The cell developed at the REP chair is used in a coupled experimental setup with the free jet nozzle to investigate the spray pattern. This combination of the dynamic solubility test and the spray pattern test results in an increased significance of the results, since the processes in the free jet can be put into a direct relation to the flow behavior in the cell. The two high-speed cameras used each document a partial test. The recording parameters and the experimental setup of the nozzle with lighting and camera are summarized in Fig. 4.

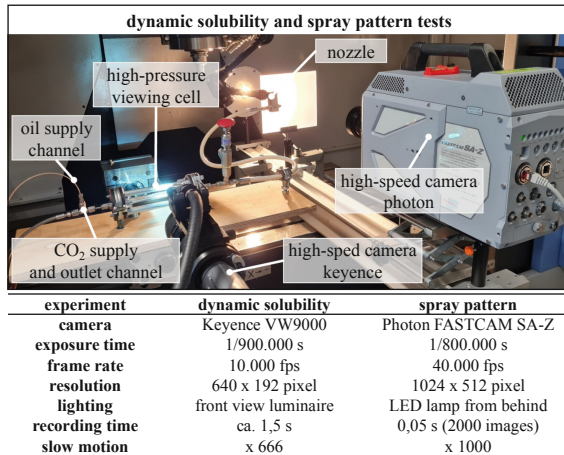


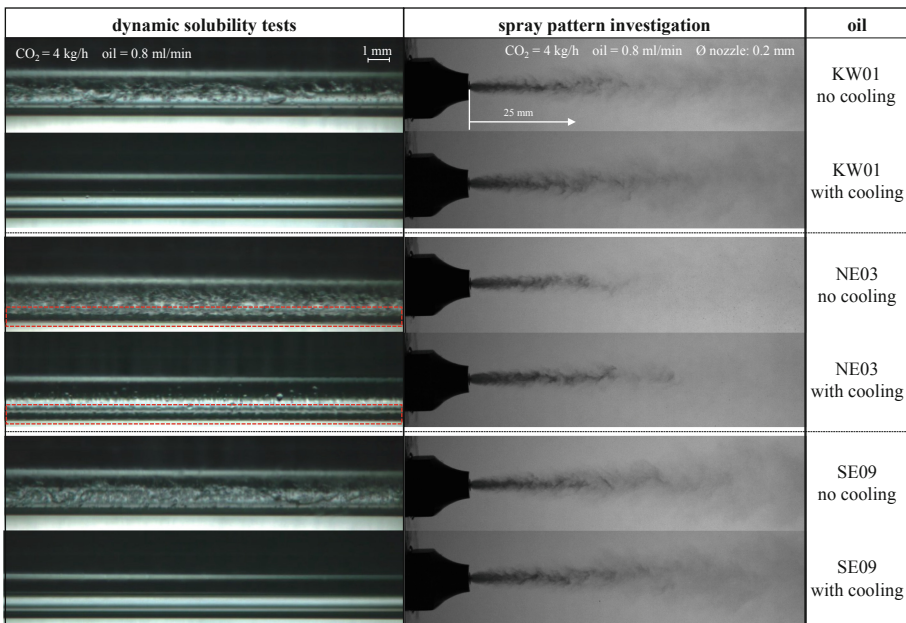
Fig. 4. Experimental setup dynamic solubility and spray pattern tests

## 4 Results

The video material of the dynamic viewing cell is evaluated with regard to the assessment of the tested oils with the aid of the “laminar boundary flow” criterion. This is the phenomenon of a laminar boundary flow with a sawtooth shape forming in the lower part of the viewing area during the flow process in the case of NE03 base oil, which flows more slowly than the rest of the CO<sub>2</sub>-oil mixture. This occurrence is marked with a red box in Fig. 5. This event occurs in all additivated variants of this base oil. In this study, as already mentioned, only the pure base oils will be discussed in detail.

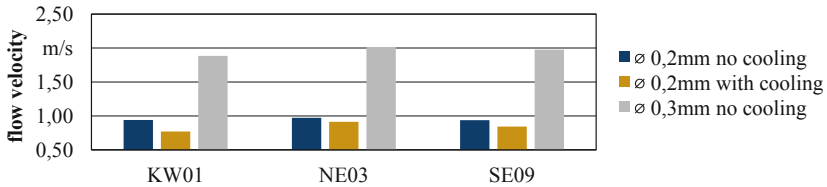
When the experiment is carried out with variation of boundary conditions by CO<sub>2</sub> cooling, the contents of the viewing cell become much clearer with cooling of the CO<sub>2</sub> and are characterized by fewer visible individual particles, see Fig. 5. Using the base oil NE03 as an example, significantly fewer detectable CO<sub>2</sub> particles are evident at higher density. Complementary, a lower pulsation in the mass flow of LCO<sub>2</sub> was detected with pre-cooled CO<sub>2</sub>. The density is also characterized by higher stability during the feed. Laminar boundary flow, typical for the NE 03 oil with high viscosity, cannot be

prevented by cooling. The density of the CO<sub>2</sub> does not seem to have any influence on this phenomenon. In further series of experiments it was shown that the flow velocity of the CO<sub>2</sub>-oil mixture does have an influence on the laminar boundary flow. With increasing flow velocity in the pipe, the laminar boundary flow decreases or does not occur at all. In this test setup, the influence of pre-cooled CO<sub>2</sub> on the spraying behavior was investigated for a nozzle diameter of  $d_i = 0.2$  mm. It was shown that due to the higher density of the CO<sub>2</sub>, which was demonstrably achieved with the cooling, the spraying behavior changes. The main jet gives a focused impression which is also superior in length to that without CO<sub>2</sub> cooling. Cooling the CO<sub>2</sub> increases the atomization of the oils and widens the spray corridor with a greater main jet length and intensity. A finer and wider oil application results. Process stability in terms of pulsation of the CO<sub>2</sub>-oil mixture at nozzle exit can be significantly improved.



**Fig. 5.** Results of dynamic solubility and spray pattern tests

Using the VW-9000 motion analyzer program, the videos of the dynamic view cell can be evaluated using particle tracking. The tracking tool must be calibrated to the inner diameter of the line of sight. Subsequently, a CO<sub>2</sub> or oil particle is selected and tracked over the entire line of sight. Finally, the tracked distance can be evaluated with respect to the absolute velocity. The velocities of the different oils, depending on nozzle diameter and CO<sub>2</sub> cooling, are summarized in Fig. 6.



**Fig. 6.** Flow velocity depending on nozzle diameter and CO<sub>2</sub> cooling

As expected, particles moving with a greater nozzle diameter of  $d_i = 0.3$  mm without cooling are much faster than those moving with  $d_i = 0.2$  mm without cooling. Cooling of CO<sub>2</sub> reduces the flow velocity within the feed due to higher density. When implementing CO<sub>2</sub> cooling in practical applications for machining operations, this influence must be taken into account. The influence of the lower flow velocity with simultaneously stronger atomization of the lubricant on the oil application and cooling of the contact zone of tool and workpiece must be investigated in further investigations.

## 5 Summary

In summary, the following influences of temperature-controlled carbon dioxide on sprayability and solubility in CMQL with bio-based lubricants can be determined. The cooling of the CO<sub>2</sub> increases the atomization of the oils and widens the spray corridor with a greater main spray length and intensity. The process stability in terms of pulsation of the CO<sub>2</sub>-oil mixture at nozzle exit can be significantly improved with an increase in density from 550 kg/m<sup>3</sup> to over 800 kg/m<sup>3</sup>. By cooling the CO<sub>2</sub>, the cell content appears transparent due to completely liquid state and flow velocity is slowed down. NE03 provides a slower boundary flow of oil deposited at the outer edge of the viewing cell, even during cooling. This is in agreement with the results of previous investigations of the REP chair which showed that the boundary flow disappears at a higher flow velocity. In addition to the investigation of the influence of lower flow velocity with simultaneously stronger atomization of the lubricant on the machining, further factors of the cooling method must be investigated in detail. These include the influence of cooling at higher flow rates and velocities, but also the components of the cooling system in terms of cooling capacity, cooling length and the materials used.

**Acknowledgments.** The results are part of the research project “Development of bio-based metalworking oils for cryogenic minimum quantity lubrication”. Thanks go to the German Agency for Renewable Resources and the German Federal Ministry of Food and Agriculture for funding the joint project. The consortium consists of REP-Chair FAU Erlangen-Nuremberg, Gühring, EagleBurgmann, Schaeffler, Fuchs, Rhenus and Blaser.

## References

1. Behr, A., Seidensticker, T.: Einführung in die Chemie nachwachsender Rohstoffe: Vorkommen, Konversion, Verwendung. Springer, Berlin, Heidelberg (2018)
2. Hanenkamp, N., et al.: Hybrid supply system for conventional and CO<sub>2</sub>/MQL-based cryogenic cooling. *Procedia CIRP* **77**, 219–222 (2018)
3. Gross, D., et al.: Milling of Ti6Al4V with carbon dioxide as carrier medium for minimum quantity lubrication with different oils. *Procedia Manuf.* **43**, 439–446 (2020)
4. Meier, T., et al.: Investigation of lubricating oils from renewable resources for cryogenic minimum quantity lubrication. *MM Sci. J.* **2021**(5), 5069–5076 (2021)
5. Meier, T., et al.: Investigation of the influence of the additivition of a biological metalworking oil in cryogenic machining. *Procedia CIRP* **105**, 694–699 (2022)
6. Pursell, M.: Experimental investigation of high-pressure liquid CO<sub>2</sub> release behaviour: Health and Safety Laboratory. In: Symposium Series NO. 158 (2012)
7. Krämer, A.: Gestaltungsmodell der kryogenen Prozesskühlung in der Zerspanung. Dissertation. Aachen (2015)
8. Verein Deutscher Ingenieure. VDI-Wärmeatlas: Mit 320 Tabellen. Berlin (2013)
9. Gross, D.: Untersuchungen zur kohlenstoffdioxidbasierten kryogenen Minimalmengenschmierung. Dissertation. Erlangen (2021)

**Open Access** This chapter is licensed under the terms of the Creative Commons Attribution 4.0 International License (<http://creativecommons.org/licenses/by/4.0/>), which permits use, sharing, adaptation, distribution and reproduction in any medium or format, as long as you give appropriate credit to the original author(s) and the source, provide a link to the Creative Commons license and indicate if changes were made.

The images or other third party material in this chapter are included in the chapter's Creative Commons license, unless indicated otherwise in a credit line to the material. If material is not included in the chapter's Creative Commons license and your intended use is not permitted by statutory regulation or exceeds the permitted use, you will need to obtain permission directly from the copyright holder.





# Sustainability Enhancement of the Coal Based Direct Reduction of Iron Premised on a Rotary Kiln

Ratidzo Yvonne Nyakudya and Michael Ayomoh<sup>(✉)</sup>

University of Pretoria, Private Bag X20, Hatfield, Pretoria, South Africa  
michael.ayomoh@up.ac.za

**Abstract.** Sustainability of steel manufacturing industries in most under developing economies around the globe has become an issue of concern bothering around both environmental and systemic sustainability. The principles of circular economy (CE) in systems thinking (ST) have been proposed in this paper as a measure towards augmenting the sustainability of coal based Direct Reduction of Iron (DRI) process. The DRI approach for steel production is preferred for economic reasons in most low-income countries, even though it is an inevitably dirty process, emitting gaseous and solid wastes in large quantities. The pollution level of the DRI process violates the United Nations sustainable development goal no. 13 which focuses on climate action. The concept of CE in ST has been presented as a comprehensive measure that is capable of reducing and aiding with the recovery of wastes in the DRI process through effective tracing, tracking and control within an integrated network.

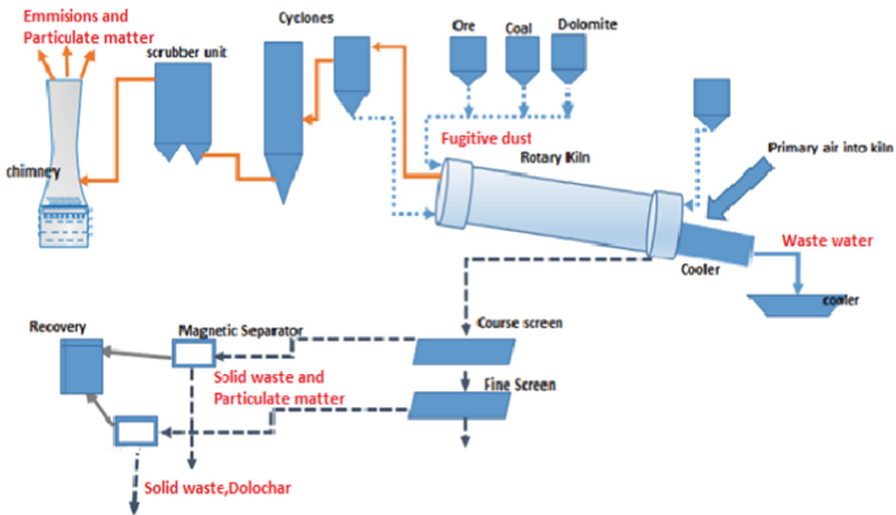
**Keywords:** Direct Reduction of Iron · Sponge Iron · Wastes · Sustainability · Circular Economy · Systems Thinking

## 1 Introduction

Sustainability has become increasingly important amongst industries worldwide over the past decade. Organizations are directing their resources towards the minimization of environmental impact of their products and operations [1]. Coal based Direct Reduction (DRI) of Iron is one sector that needs attention on environmental sustainability as it has greatly expanded over the past decade [2]. Sponge Iron has gained more use in the steel making industries in the (EAF) Electric Arc furnace due to its high iron content, less availability of high-quality scrap and the increasing cost of scrap metals [3, 4]. Coal is an abundantly available resource in many developing countries and is used to power energy intensive industrial processes [5]. The use of electricity and natural gas is limited in powering these processes because of the cost associated with it. Globally, India has been the largest producer of sponge iron up to 2018, and 80% of DRI plants in India are coal powered [6].

### 1.1 The DRI Process

Sponge Iron or Direct Reduction Iron (DRI) refers to a porous metallic substance that is produced by the direct reduction of iron ore, where oxygen is removed from the iron oxide using coal or natural gas as reductants and dolomite as a desulphurizing agent [7]. Raw materials are fed into the rotary Kiln by a conveyor to generate fugitive dust and particulate matter. The kiln has 2 zones, the preheating zone is responsible for moisture removal from the raw materials at temperatures ranging 900 °C-1000 °C and thermal decomposition of coal takes place releasing hydrocarbons and hydrogen. The metallization zone is where the final reduction to metallic iron takes place with most CO<sub>2</sub> reduced to CO. A lot of emissions are generated during this stage from combustion reactions in the kiln [2]. After the reduction process, a mixture of sponge iron and char is discharged from the kiln into the cooler where cooling takes. Water is sprayed at the cooler shell to indirectly cool the material from about 1000 °C to 120 °C. Coal based DRI units are critically air polluting in nature emitting high concentration of particulate matter from point sources [2, 4]. Figure 1 shows a schematic diagram of the DRI process including the various waste outlets.



**Fig. 1.** Schematic process flow diagram of DRI, showing sources and exit points for wastes

Raw material utilization and waste generation for the DRI suggest that 1.6 tonnes of ore, 1.2 tonnes of non-coking coal and 0.05 tonnes of dolomite are needed to produce 1 tonne of sponge iron and 0.2 tonnes of solid wastes [2, 5]. This implies that for every 10 tonnes of sponge iron produced, almost 2 tonnes of solid wastes are produced in the form of semi-processed iron and coal char. Most DRI plants are medium scale producers, with a capacity of 100 tonnes per day (100TPD). Such plants have the potential of disposing up to 20 tonnes of solid waste into the environment, thus causing environmental degradation. CE principle helps to recover waste by recycling and giving it a second life as a new product.

## 2 Circular Economy in Systems Thinking for Sustainability of the DRI Process

The concept of Circular Economy (CE) depicts the life cycle of a system from conception to completion and utmost disposal or recycling. Systems Thinking (ST) is a holistic approach to understanding a systemic problem and the interrelationship that exists amongst the members of a system. The European Commission [8] stated that CE is a concept premised on five monitorable processes [9] namely: i) system input, ii) design & development, iii) production and deployment, iv) operations and/or consumption, and v) discard or recycle. CE in ST allows for a much broader utilisation of a ST network diagram to not only understand the problem comprehensively, but to proffer an integrated solution comprising all stakeholder in the DRI production process. The sustainability of any system such as the DRI, is premised on the proffering of a holistic solution to identified problems. Several system networking and mapping tools can be utilised for a comprehensive integration and exploration of a system's elements. In this paper, the VENSIM software was deployed for the ST network of elements. This was used to demonstrate how the elements of the DRI process interact to enable circularity of the system. From Fig. 2, both negative and positive interactions can be identified and mitigated as deemed necessary for sustainability of the DRI system. The output of one systemic element serves as an input to another element in a looped network depicting circularity from raw material acquisition through the processing phases and stages to disposal. Stakeholders responsible for the facilitation of the different activities in the network are known prior. Negative activities within the network can be easily traced and tracked. Also, effective control measures can be easily disseminated amongst the stakeholders in the circular system for sustainability.

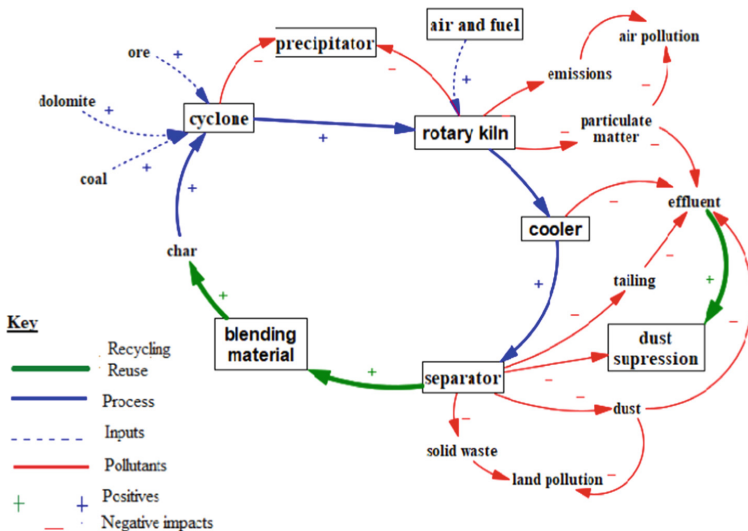


Fig. 2. Systems map for the DRI process



The developed map enables visualization of the impacts of the DRI process and how they contribute to pollution and land degradation. The concept of CE in ST aids decision makers and stakeholders to have a much clearer perspective of the sustainability measure of the DRI system throughout its life cycle. The ST map can also be used to generate a causative tree diagram for the problematic processes with a view towards optimizing the process through visualization of the displayed quantities of the causative factors. Circularity of the DRI process can be achieved by reusing and recycling waste products back into the process. From the systems map, it is seen that waste dolochar can be blended with other materials in the cyclones and used as feed in the rotary kiln. Up to 20 tonnes of dolochar can be recycled back into the system for a 100TPD capacity plant, and this cuts on the cost of raw materials utilised. Wastewater from the cooler can be used for dust suppression, though some academics argue that mineral elements can be leached into the soil from this process.

### 3 Wastes from Coal Based DRI Process

The Sponge Iron production is critically air polluting in nature emitting high concentration of particulate matter from point sources and from several secondary sources. The three main types of wastes generated are solid wastes, liquid wastes, and gaseous emissions.

#### 3.1 Wastewater

Wastewater is generated from scrubbers, After Burning Chamber (ABC) and coolers, it is processed in the classifier which is used for the removal of coarse, heavy, and suspended particles [10]. Total wastewater per tonne of sponge iron is  $2.88 \text{ m}^3$ , this comes from the ABC, clarifier, wet scrubber, and the dust suppression system. Overflow of the clarifier goes to the cooling tower while underflow of the clarifier goes to the sludge pond. Water is continuously sprinkled over the rotary cooler shell and is allowed to fall on a setting tank located below the rotary cooler. The water requirement varies from 5-6 kl/h 100 TPD DRI [11]. Wastewater can be treated and recycled in the system for dust suppression.

#### 3.2 Dust and Particulate Matter

Major sources of fugitive dust generation in coal based DRI plants are the raw material handling yard (unloading, stacking, reclaiming operations), product discharge system (cooler discharge conveyors, transfer points), junction house, screens, magnetic separators, storage silos. The summation of these waste adds to 0.13 tonnes/tonne of DRI produced [11] The main raw materials, coal and iron need to be crushed to a size between 0–20 mm, sizing of raw materials involve the crushing, screening, and conveying operation. During these processes, fines are generated, and micron size dust is dispersed in the air. Particulate matter (PM) consists of particles that, based on their size are classified in coarse (diameter  $< 10 \text{ }\mu\text{m}$ ; PM10), fine (diameter  $< 2.5 \text{ }\mu\text{m}$ ; PM2.5) and ultrafine ( $0.1 < \mu\text{m}$ ; PM0.1) [12].

### 3.3 Gaseous Emissions

Emissions or pollutants into the air results in undesirable changes to the climate and this degrades the environment. A lot of emissions are produced during the DRI process because of the various reactions of carbon from coal thus producing a lot of carbon derived emissions. Principal air emissions include particulate matter (PM, or dust), Sulphur dioxide (SO<sub>2</sub>), nitrogen oxides (NO<sub>x</sub>), carbon dioxide (CO<sub>2</sub>), carbon monoxide (CO), lead and ozone [12]. The process of employing coal as a reducing agent produces a lot of CO<sub>2</sub> and CO from the reactions between the carbon and iron oxide inside the kiln. [13].

### 3.4 Solid Waste, Coal Char and Dolochar

Studies on characterization of dolochar suggests that the dolochar samples from various dump sites consist of quartz (free as well as locked), free lime, aluminum silicate, Fe particles, and Ca or Mg and or Ca + Mg + Fe oxide phases [14]. Proximate analysis indicates that the dolochar fine samples contain more fixed carbon than the dolochar lump samples [5]. The concentration of heavy metals is also more in case of fine samples than the lump samples. The (Fe) content is invariably the same in both lump and fine dolochar samples. Dolochar or solid waste contributes to the highest volume of waste generated, the quantity ranges from 0.2–0.3 tonnes/tonne of DRI produced.

### 3.5 Impact of Waste from Sponge Iron Production

Wastes generated from the DRI process have adverse effect on the environment and human life. Wastewater from this process contains metals, suspended solids, benzene, and fluorides. These degrades the soil and water bodies as the sludge is disposed in the environment [14]. Effluent discharge also alters water quality and PH, thus resulting in hard water formation. Emissions such as (SO<sub>2</sub>), NO<sub>x</sub>, CO<sub>2</sub>, CO, cause a number of diseases such as increased pulse rate, cardiovascular disease, throat irritation, bronchitis, eye irritation, chest pain, drowsiness, headache, nausea, stupor, coma, disorientation [15]. GHGs contributes to global warming and acid rain while dust and particulate matters cause stunted plant growth and soil contamination from dissolved metals leached from deposited dust. In humans, pulmonary health problems such as black lung disease and bronchitis are associated with inhaling particulate matters [16].

## 4 Pollution Drivers in Sponge Iron Production

In a bid to manage and enhance sustainability of the DRI process, the following pollution drivers as listed in Table 1 would need to be kept at the barest minimum. Different researchers have in the past deployed diverse but specific strategies per pollutant type as presented in Table 1 towards their minimization. These specific strategies can be assessed and deployed within the ST and CE integrated approach.

**Table 1.** Pollutants and specific control strategies

Pollutant	Strategy
CO <sub>2</sub>	Use of wood char as a reductant instead of coal, to reduce the amount of CO <sub>2</sub> produced [17] Optimisation of the DRI process through multiscale process modelling to reduce CO <sub>2</sub> emissions [6, 18]
Particulate matter	Application of EPA air pollution dispersion model ISCST-3 to predict the impact of the sponge iron industry emissions on ambient air quality [19]
Dust and Particulate matter	Gas Cleaning Plant (GCP) based on Venturi Scrubbers for the treatment of DRI gases [11]
Dolochar	Recycling of solid wastes e.g., dolochar can be used as a low cost and highly efficient adsorbent for phosphate removal from aqueous solution [20]
Char	Recycling, char mixed with coal fines can be used as fuel in Fluidized Bed Combustion Boilers (FBC) [2] Reuse of char as an element for denitrification in wetlands [21]

## 5 Conclusion

The Integration of Circular Economy and Systems thinking has a great potential in the enhancement of sustainability of different processes as this enables holistic understanding of the problem domain coupled with the proffering of an integrated solution. The Coal based DRI processes can be sustained over time if proper holistic strategies are deployed to monitor and control the network of activities. This would minimize the overall cost of the production process and negative impact on the environment. The 3Rs (Reduce, Reuse and Recycle) for sustainability would certainly be achievable if an integrated approach such as CE in ST is adopted.

## References

1. Kaebernick, H., et al.: “No 主観的健康感を中心とした在宅高齢者における健康関連指標に関する共分散構造分析Title. In: Proceedings 13th CIRP International Conference Life Cycle Engineering LCE 2006, vol. 1, no. 1, pp. 1–15 (2015). <https://doi.org/10.4314/ijest.v2i7.63754>
2. Sengupta, N., Mitra, S., Agrawal, K.M.: Environmental performance evaluation of sponge iron industries in India - an overview. In-dian J. Environ. Prot. **36**(10), 860–873 (2016)
3. NPC: Best Practices Manual for Reducing GHG Emissions in Iron & Steel (Sponge Iron) Sector of India, p. 95. <http://www.npcindia.gov.in/wp-content/uploads/2014/07/GHG-Manual-Iron-Steel-Final.pdf> (2017)
4. Dattagupta, N.: Environmental sustainability assessment of sponge iron industries in West Bengal using DEA. Int. J. Res. Anal. Rev. **5**(4), 171–174 (2018)
5. Dwari, R.K., Rao, D.S., Swar, A.K., Reddy, P.S.R., Mishra, B.K.: Characterization of dolochar wastes generated by the sponge iron industry. Int. J. Miner. Metall. Mater. **19**(11), 992–1003 (2012). <https://doi.org/10.1007/s12613-012-0660-9>

6. Ramakgala, C., Danha, G.: A review of ironmaking by direct reduction processes: quality requirements and sustainability. *Procedia Manuf.* **35**, 242–245 (2019). <https://doi.org/10.1016/j.promfg.2019.05.034>
7. Dutta, S.K., Sah, R.: Direct Reduced Iron: Production. In: Colás, R., Totten, G. E. (eds.) *Encyclopedia of Iron, Steel, and Their Alloys*, pp. 1082–1108. CRC Press (2016). <https://doi.org/10.1081/E-EISA-120050996>
8. European Commission EU-report on critical raw materials and the circular economy SWD 2018, pp. 1–68 (2018)
9. Elia, V., Gnoni, M.G., Tornese, F.: Measuring circular economy strategies through index methods: a critical analysis. *J. Clean. Prod.* **142**, 2741–2751 (2017). <https://doi.org/10.1016/j.jclepro.2016.10.196>
10. Sarna, S.K., et al.: Environmental performance evaluation of sponge iron industries in India – An overview. <http://Ispatguru.Com>, vol. 5, no. 164. Pp. 364–369. <http://ispatguru.com/direct-reduced-iron-and-its-production-processes/> (2006)
11. Moharana, H.S., Mohanty, B.B.: The environmental pollution and control- solution in sponge iron industries. *Int. J. Appl. Res. Mech. Eng.* **2**(1), 37–39 (2012). <https://doi.org/10.47893/ijarme.2012.1059>
12. Sun, W., Zhou, Y., Lv, J., Wu, J.: Assessment of multi-air emissions: case of particulate matter (dust), SO<sub>2</sub>, NO<sub>x</sub> and CO<sub>2</sub> from iron and steel industry of China. *J. Clean. Prod.* **232**, 350–358 (2019). <https://doi.org/10.1016/j.jclepro.2019.05.400>
13. Runkana, V.: Modelling and optimisation of direct reduction of iron ore by coal in a rotary kiln Optimal glucose control View project Digital Twins View project (2010)
14. Samal, S.K., Sahoo, P.K., Behera, D.K.: Physico-chemical Characterization of Sponge Iron Solid Waste of Maithan Steel Plant - A Case Study, vol. 6, no. 10, pp. 683–688 (2017)
15. Chattopadhyay, K., Chattopadhyay, C., Kaltenthaler, E.: Health-related quality-of-life of coal-based sponge iron plant workers in Barjora, India: a cross-sectional study. *BMJ Open* **4**(9), e006047–e006047 (2014). <https://doi.org/10.1136/bmjopen-2014-006047>
16. Smargiassi, A., et al.: Associations between personal exposure to air pollutants and lung function tests and cardiovascular indices among children with asthma living near an industrial complex and petroleum refineries. *Environ. Res.* **132**, 38–45 (2014). <https://doi.org/10.1016/j.envres.2014.03.030>
17. Gupta, R.C.: Woodchar as a sustainable reductant for iron-making in the 21<sup>st</sup> century. *Miner. Process. Extr. Metall. Rev.* **24**(3–4), 203–231 (2003). <https://doi.org/10.1080/714856822>
18. Rami, B., Hamadeh, H., Mirgoux, O., Patisson, F.: Optimization of the Iron Ore Direct Reduction Process through Multiscale Process Modeling, pp. 1–18 (2018) <https://doi.org/10.3390/ma11071094>
19. Rao, P.S., Kumar, A., Ansari, M.F., Pipalatkhar, P., Chakrabarti, T.: Air quality impact of sponge iron industries in central India. *Bull. Environ. Contam. Toxicol.* **82**(2), 255–259 (2009). <https://doi.org/10.1007/s00128-008-9519-1>
20. Rout, P.R., Bhunia, P., Dash, R.R.: Effective utilization of a sponge iron industry by-product for phosphate removal from aqueous solution: a statistical and kinetic modelling approach. *J. Taiwan Inst. Chem. Eng.* **46**, 98–108 (2015). <https://doi.org/10.1016/j.jtice.2014.09.006>
21. Si, Z., et al.: Untangling the nitrate removal pathways for a constructed wetland- sponge iron coupled system and the impacts of sponge iron on a wetland ecosystem. *J. Hazard. Mater.* **393**, 122407 (2020). <https://doi.org/10.1016/j.jhazmat.2020.122407>



**Open Access** This chapter is licensed under the terms of the Creative Commons Attribution 4.0 International License (<http://creativecommons.org/licenses/by/4.0/>), which permits use, sharing, adaptation, distribution and reproduction in any medium or format, as long as you give appropriate credit to the original author(s) and the source, provide a link to the Creative Commons license and indicate if changes were made.

The images or other third party material in this chapter are included in the chapter's Creative Commons license, unless indicated otherwise in a credit line to the material. If material is not included in the chapter's Creative Commons license and your intended use is not permitted by statutory regulation or exceeds the permitted use, you will need to obtain permission directly from the copyright holder.





# The Influence of the Rake Angle on the Cutting of Low-Lead and Lead-Free Brass Alloys

Magdalena S. Müller<sup>(✉)</sup>  and Knut Sørby 

Department of Mechanical and Industrial Engineering, Norwegian University  
of Science and Technology, 7491 Trondheim, Norway  
`magdalena.s.muller@ntnu.no`

**Abstract.** Components manufactured from brass alloys are widely used in plumbing systems. Traditionally, lead is added to the alloy to improve the machinability. In recent years, the use of lead has been restricted due to health and environmental concerns. New lead-free and low-lead alloys were developed. These alloys usually show a higher cutting force compared to traditional lead-containing brasses. This paper investigates the influence of different rake angles and tool coating on cutting force and chip formation. The two lead-free brass alloys, CW511L and CW724R, are compared to the low-lead brass CW625N.

**Keywords:** Lead-Free Brass · Cutting Tool · Machinability

## 1 Introduction

Due to its favorable properties, brass is widely used in different applications, for example in couplings for drinking water supply systems. Brass is electric-conductive, antibacterial, and nonmagnetic. Different elements added to brass can change the properties of the alloy. In general, lead is known to enhance chip breakability and reduce cutting forces. This is commonly explained by the non-solubility of lead in brass, which causes the precipitation of lead particles around the grain boundaries, and the low melting point of lead compared to brass. Johansson et al. compared a lead-containing and a lead-free brass alloy. The tool-chip contact length was significantly shorter, and the friction coefficient was lower when machining lead-containing brass. By studying chip roots, it was found that lead in brass acts as a crack initiation point, contributing to discontinuous chips. However, no evidence was found for lead melting during the machining process [5]. However, lead can be toxic to humans and the environment. For this reason, many countries restrict the use of lead, such as the EU, the United States, Japan, and Canada. The restrictions are likely to tighten in the future [4]. As a result of this, new low-lead and lead-free brass alloys were developed. To compensate for the missing lead and its favorable effects, different elements were added. A widely studied lead-free brass is the silicon-alloyed special brass CW724R. CW724R shows increased cutting forces compared to lead-alloyed brass, but lower cutting forces than other lead-free alloys [10]. These are probably caused

by the brittle  $\kappa$ -phase, which is precipitated during solidification and as a result of silicon. In addition to the different alloying elements, the cutting forces can also be influenced by the tool geometry, the tool coating and the cutting conditions. Nobel et al. investigated the influence of tool geometry on chip breaking in the cutting of brass. In general, the rake angle had a lower influence compared to the chip-breaking geometry. A negative rake angle leads to increased cutting forces and average chip breakability in cutting CW511L [8]. In another study, Nobel et al. concluded that a TiAlN-coated carbide tool showed the lowest tool wear, a multilayer chemical vapor deposition (CVD)-diamond-coated carbide tool showed the lowest adhesion of carbide tools, and a polycrystalline diamond (PCD) tool had the best overall performance for the cutting of brass [6]. In general, for the more ductile copper-base alloys without lead addition, tools with a higher rake angle between  $10^\circ$  and  $20^\circ$  are recommended [3]. A higher rake angle will lead to a higher shear angle and thereby to lower cutting forces. On the other hand, a higher rake angle gives a smaller wedge angle. Thus, the tool is weakened and might wear out more quickly. Therefore, high rake angles are usually only used in difficult to machine high-ductility materials [7].

The goal of this paper is to investigate the influence of the rake angle and a AlTiN tool coating on the cutting forces and the tool wear in cutting of low-lead and lead-free brass. The alloys investigated are CW724R, CW511L, and CW625N. In the next section, the methods used in this paper are described, followed by the results and a discussion of the results, and a conclusion.

## 2 Materials and Methods

This study investigates and compares the cutting forces in the lead-free brass alloys CW511L and CW724R with the low-lead brass alloy CW625N. All alloys were supplied as extruded rods. LG123L1-0600-BG H13A carbide inserts from Sandvik Coromant were used. In preparation, the inserts were ground by the toolmaker company DanSpecial, and half of the inserts were coated. Four different rake angles  $0^\circ$ ,  $8^\circ$ ,  $16^\circ$ , and  $24^\circ$  and clearance angles of  $6^\circ$  to  $8^\circ$  were prepared. As a coating, the AlTiN-based FerroCon coating by CemeCon was applied by high-power impulse magnetron sputtering. According to Klocke et al. this coating gave slightly reduced cutting forces compared to uncoated tungsten carbide [6]. Investigations on a tribometer by Nobel et al. showed also lower friction for this coating compared to uncoated tungsten carbide with brass as counter body [9]. To minimize the influence of the tool nose in the cutting tests, in preparation, 5 mm wide grooves were cut in the rods, resulting in 2 mm wide disks. Cutting tests were performed on a Weiler Commodor 230 VCD open lathe under dry cutting conditions to measure cutting forces. A Kistler dynamometer was used to measure the cutting forces, and a LabView application was utilized. A constant cutting speed of 150 m/min was used, the width of cut was 2 mm as the disks. The feed was varied in four levels: 0.05, 0.1, 0.16, and 0.2 m/min. All tests were repeated three times. The chips were collected after each cut.

The geometry of the tool edge was analyzed on an Alicona InfiniteFocus microscope using focus variation prior to the cutting tests. The shape of the tool

edge was analyzed using a 10x magnification and the integrated edge measurement software tool. Measurements were taken at three different positions, and the average was calculated. According to the results, all the tools had a form factor  $K$  of 1, and the cutting edge segments were symmetric. The edge rounding  $r$  varied from 7 to 18  $\mu\text{m}$  depending on the tool, and the profile flattening  $\Delta r$  of the tools varied from 4 to 23  $\mu\text{m}$ , for detailed information, see Table 1.

Furthermore, the surface roughness of the coated and uncoated  $0^\circ$  rake angle tool was measured on the rake face and the clearance face in both the radial and transverse directions. A Mahr Perthometer M2 was used with a sampling length of 0.25 m/min. The average results of the five repetitive measurements can be found in Table 2.

**Table 1.** Measurements of the tool geometry.

Rake angle $\gamma$ [°]	Condition	Wedge angle $\beta$ [°]	Edge rounding $r$ [ $\mu\text{m}$ ]	Cutting edge segment on flank face $S_\alpha$ [ $\mu\text{m}$ ]	Cutting edge segment on rake face $S_\gamma$ [ $\mu\text{m}$ ]	Profile flattening $\Delta r$ [ $\mu\text{m}$ ]
0	Uncoated	84	7	9	9	4
0	Coated	84	16	19	19	8
8	Uncoated	75	16	23	23	13
8	Coated	76	13	21	21	12
16	Uncoated	66	14	23	23	13
16	Coated	68	17	28	28	15
24	Uncoated	60	18	36	36	23
24	Coated	60	17	31	31	18

**Table 2.** Surface roughness measurements of the rake face and clearance face.

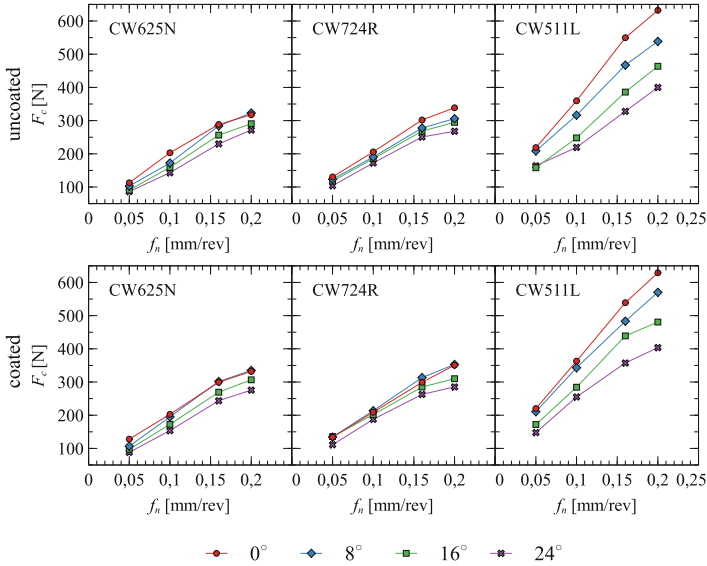
Tool	$Ra$ rake face, radial [ $\mu\text{m}$ ]	$Ra$ rake face, transversal [ $\mu\text{m}$ ]	$Ra$ clearance face, radial [ $\mu\text{m}$ ]	$Ra$ clearance face, transversal [ $\mu\text{m}$ ]
$0^\circ$ , uncoated	0.013	0.011	0.103	0.206
$0^\circ$ , coated	0.049	0.05	0.237	0.238

### 3 Results and Discussion

From the three repetitive force measurements, the average was calculated. Figure 1 shows the calculated average main cutting force  $F_c$  plotted over the feed values  $f_n$  used for the different tools and workpiece materials. The main cutting force was the highest in the CW511L alloy, on average around 70% higher than in the CW625N alloy. This difference was higher for lower rake angles and decreased with increasing the rake angle. Also, it was slightly lower for the coated tools. The main cutting force in the CW724R alloy was approximately



10% higher than in CW625N. Here, the difference was slightly higher for the coated tools. Furthermore, the difference increased with increasing rake angle and was the highest for the tool with a rake angle of 16° but decreased slightly for the rake angle of 24° for coated and uncoated tools.



**Fig. 1.** Average main cutting force against feed for different tools and alloys.

Furthermore, it is visible in Fig. 1 that the main cutting force increases with increasing feed. From the comparison of the linear trend line, it is visible that this effect is the strongest for CW511L but decreases with increasing rake angle. For CW724R and CW625N, the slopes are relatively similar and slightly decreasing with increasing rake angle. When comparing the different rake angles with the 0° rake angle tool, overall, the cutting force decreased more for the uncoated tools than for the coated tools. The decrease in cutting forces increased with increasing rake angle for both coated and uncoated tools and all materials. The achievable reduction was the highest for CW511L and the lowest for CW724R, but even the minimum cutting forces for a particular feed in CW511L are still higher than the highest cutting forces for the same feed in CW724R or CW625N. Overall, the coating has only a minor effect on the cutting forces, as it increases the cutting force on average by 6%, 7%, and 5% for CW625N, CW724R, and CW511L, respectively.

To further interpret the data, an ANOVA was performed using Minitab software. According to the results, all four factors: rake angle, feed, material, and coating, had a statistically significant impact. Additionally, the interactions between rake angle and material, feed and material, and rake angle and coating were statistically significant. The fit of model was  $R^2 = 99,40\%$ . Figure 2 shows

the main effect plot. A Turkey-pairwise comparison revealed that there are no significantly different means for the combinations of 0° rake angle and no coating with 0° rake angle and the coating, 8° and coated with 0° and uncoated, and 16° coated with 8° uncoated. Also, means were not significantly different for a feed of 0.2 mm/rev and CW625N compared to a feed of 0.1mm/rev and CW511L. For the combination of rake angle and material, 0° in CW724R and 8° in CW724R, 8° in CW724R and 0° in CW625N, 0° in CW625N and 16° in CW724R, and 24° in CW724R and 16° in CW625N showed no significantly different means. The results show that CW625N should be cut with a high rake angle and a low feed rate to achieve the lowest possible cutting force. On the contrary, cutting CW511L at a high feed rate and a low rake angle leads to the highest cutting forces. The coating condition has only a minor influence on the cutting force.

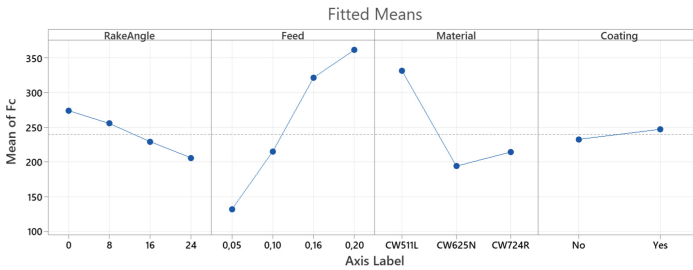
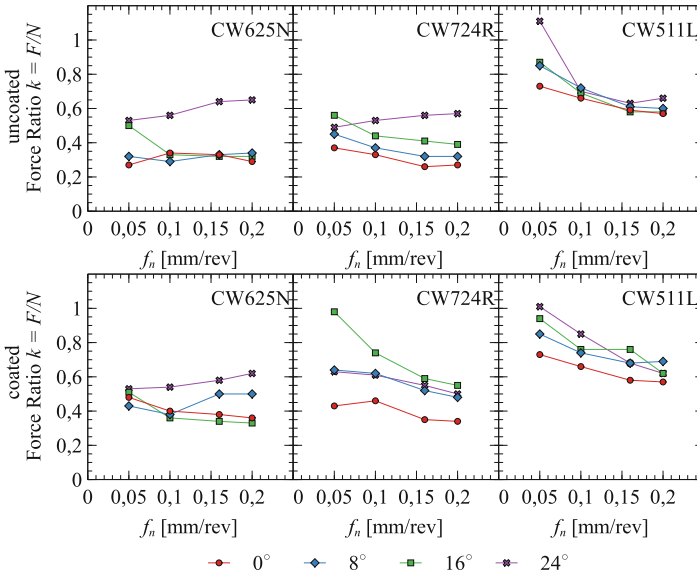


Fig. 2. Main effects plot for  $F_c$ .

The cutting forces are measured in machine coordinates. To calculate the forces parallel and normal to the rake face, the machine coordinates must be rotated with the rake angle. Thus, the friction force  $F$  and the normal force  $N$  to the friction force can be calculated from the measured cutting and feed force. These two components are often used to calculate a friction coefficient. That does not seem to reflect reality but rather a force ratio  $k = F/N$ , which nevertheless depicts the friction conditions [1,6]. When considering tool edge geometry, Albrecht concluded that the coefficient of friction is no longer increasing with the rake angle [1]. However, the force ratios for the different materials and tools are plotted against the feed in Fig. 3. As a general trend, it is noticeable that the force ratios are highest in CW511L and lowest for CW625N. A possible explanation is differences in the chemical composition and the microstructure of the alloys. In CW625N, the lead might act as an internal lubricant in the cutting zone and reduces friction [6]. Although in CW724R there is brittle  $\kappa$ -phase present, which increases the breakability of the chip and reduces the adhesion to the tool, CW511L consists mainly of soft  $\alpha$ -phase and therefore shows the highest cutting force ratios, and thus the highest friction in the cutting zone [6]. Surprisingly, the force ratios increased for the coated tools compared to the uncoated tools. In turning tests in wet conditions, Klocke, Nobel, and Veselovac measured slightly decreased force ratios [6]. That might be due to the influence

of the cutting fluid used. However, due to the increased hardness of the coating, lower force ratios and lower friction also are expected in dry conditions. That is supported by Nobel et al., who performed friction tests in dry conditions with uncoated and TiAlN coated tungsten carbide on CW511L and observed a reduction in friction with the application of the coating [9]. A possible explanation for the higher force ratios measured in this study is the two to four times higher roughness values for the coated tools compared to the uncoated tools; see Table 2.



**Fig. 3.** Cutting force ratio  $k$  for different tools and materials.

The shape and length of the chips have an impact on the stability and reliability of the process, especially in automated machining. Long, unbroken chips can wrap around the tool or workpiece and damage the newly generated surface. On the contrary, extremely small chips can damage the machine tool by clogging the filter system for the cooling lubricant. For the transport of the chips, they must be neither too long nor too short. In general, chip forms like ark chips, elemental chips, or short tubular and helical chips are favorable, while long spiral or helical chips, snarled chips, and needle chips, are unfavorable. The chip form can be influenced by several factors, such as the geometry of the tool, the cutting parameters, or the use of cooling lubricant and their combined effects [2]. The chips produced during this investigation were spiral, needle, loose arc or elemental, and snarled chips. Table 3 shows the chips formed for each alloy, tool, and feed tested. For the CW625N alloy, the chips will become shorter at lower rake angles. The coating appears to increase chip breakability at lower rake angles,

while decreasing it at higher rake angles. For the uncoated tool, 8° at feed rates of 0.16 and 0.2 mm/rev or 16° and 24° at feed rates of 0.05 and 0.1 mm/rev seem favorable regarding chip breakability. Chip formers or cooling lubricants might enhance the chip breakability at high rake angles. Taking into account the slightly increased cutting forces and predominantly unfavorable chip forms, the use of AlTiN to cut CW625N cannot be recommended. Alloy CW724R shows good chip breakability for both tools, but the coating leads to unfavorable needle chips at a rake angle of 0°, and the three highest feeds tested. Overall, CW511L exhibited the worst chip breakability. The uncoated tools with the two lower rake angles exhibited acceptable chip breakability at low feed rates, while the two higher rake angles produced only snarled chips. The AlTiN coating appears to increase chip breakability, so the coating may be beneficial for the CW511L cutting process, although a slight increase in cutting force was measurable compared to the uncoated tools.

**Table 3.** Chip forms for different alloys, feeds, and rake angles. ×: Spiral chips, +: Loose/Elemental chips, ○: Needle chips, -: Snarled chips.

		CW625N				CW724R				CW511L				
		$\alpha$ in [°]												
		0	8	16	24	0	8	16	24	0	8	16	24	
uncoated	$f_n$ in [mm/rev]	0.05	×	○	+	+	+	×	×	×	+	+	-	-
		0.1	○	○	+	+	+	+	+	+	-	-	-	-
		0.16	○	+	×	×	+	+	+	+	×	-	-	-
		0.2	○	+	×	×	+	+	+	+	×	×	-	-
coated	$f_n$ in [mm/rev]	0.05	○	+	×	×	+	×	×	×	+	×	-	-
		0.1	○	×	×	×	○	+	+	+	+	+	+	-
		0.16	○	○	×	×	○	+	+	+	+	×	-	×
		0.2	○	○	×	×	○	+	+	+	+	×	-	-

### 4 Conclusion

A larger rake angle reduces the cutting forces but can have a negative effect on the chip form. This study showed that an AlTiN tool coating slightly increases the cutting forces compared to an uncoated tool. This could be due to increased friction in the cutting zone due to the higher roughness of the coated tools. However, this is contrary to studies by Nobel et al., who demonstrated slightly reduced friction when cutting the alloys CW724R and CW511L with an AlTiN-coated tool [9]. In future investigations on the rake angle and the tool coating, the impact on tool life should be considered. An increased rake angle will reduce the edge angle and potentially weaken the tool, so the tool wears out faster. On

the other hand, the decrease in cutting forces could be more eminent than a slightly reduced tool life. To improve the chip breakability, especially at higher rake angles, the use of a chip breaking geometry or high-pressure cooling should be investigated. The influence of the rake angle on the residual stresses should be investigated in further research.

**Acknowledgements.** The authors thank the Research Council of Norway for supporting this work through the research project *LOBUS - Low Lead Brass for Sustainable Community Development*.

## References

1. Albrecht, P.: New developments in the theory of the metal-cutting process: Part I. the ploughing process in metal cutting. *J. Manufact. Sci. Eng. Trans. ASME* **82**(4), 348–356 (1960). <https://doi.org/10.1115/1.3664242>, [http://asmedigitalcollection.asme.org/manufacturingscience/article-pdf/82/4/348/6494579/348\\_1.pdf](http://asmedigitalcollection.asme.org/manufacturingscience/article-pdf/82/4/348/6494579/348_1.pdf)
2. Carmignato, S.: Chip-forms, chip breakability, and chip control. In: Laperrière, L., Reinhart, G. (eds.) *CIRP Encyclopedia of Production Engineering*, pp. 245–260. Springer, Cham (2019). [https://doi.org/10.1007/978-3-662-53120-4\\_6394](https://doi.org/10.1007/978-3-662-53120-4_6394), [https://link.springer.com/referenceworkentry/10.1007/978-3-662-53120-4\\_6394](https://link.springer.com/referenceworkentry/10.1007/978-3-662-53120-4_6394)
3. Davis, J.R.: *ASM International Handbook Committee: Copper and Copper Alloys*. ASM International (2001)
4. Estelle, A.A.: Drinking water lead regulations: impact on the brass value chain (2016). <https://doi.org/10.1080/02670836.2016.1220906>
5. Johansson, J., Alm, P., M'Saoubi, R., Malmberg, P., Ståhl, J.E., Bushlya, V.: On the function of lead (Pb) in machining brass alloys. *Int. J. Adv. Manufact. Technol.* (2022). <https://doi.org/10.1007/s00170-022-09205-0>
6. Klocke, F., Nobel, C., Veselovac, D.: Influence of tool coating, tool material, and cutting speed on the machinability of low-lead brass alloys in turning. *Mater. Manufact. Process.* **31**(14), 1895–1903 (2016). <https://doi.org/10.1080/10426914.2015.1127944>, <http://www.tandfonline.com/doi/full/10.1080/10426914.2015.1127944>
7. Kuyucak, S., Sahoo, M.: A review of the machinability of copper-base alloys. *Can. Metall. Q.* **35**(1), 1–15 (1996). [https://doi.org/10.1016/0008-4433\(95\)00023-2](https://doi.org/10.1016/0008-4433(95)00023-2)
8. Nobel, C., Hofmann, U., Klocke, F., Veselovac, D.: Experimental investigation of chip formation, flow, and breakage in free orthogonal cutting of copper-zinc alloys. *Int. J. Adv. Manufact. Technol.* **84**(5), 1127–1140 (2015). <https://doi.org/10.1007/s00170-015-7749-z>
9. Nobel, C., Hofmann, U., Klocke, F., Veselovac, D., Puls, H.: Application of a new, severe-condition friction test method to understand the machining characteristics of Cu-Zn alloys using coated cutting tools. *Wear* **344–345**, 58–68 (2015). <https://doi.org/10.1016/j.wear.2015.10.016>
10. Nobel, C., Klocke, F., Lung, D., Wolf, S.: Machinability enhancement of lead-free brass alloys. *Procedia CIRP* **14**, 95–100 (2014). <https://doi.org/10.1016/j.procir.2014.03.018>

**Open Access** This chapter is licensed under the terms of the Creative Commons Attribution 4.0 International License (<http://creativecommons.org/licenses/by/4.0/>), which permits use, sharing, adaptation, distribution and reproduction in any medium or format, as long as you give appropriate credit to the original author(s) and the source, provide a link to the Creative Commons license and indicate if changes were made.








The images or other third party material in this chapter are included in the chapter's Creative Commons license, unless indicated otherwise in a credit line to the material. If material is not included in the chapter's Creative Commons license and your intended use is not permitted by statutory regulation or exceeds the permitted use, you will need to obtain permission directly from the copyright holder.



# **Materials**



# Towards Making Polymer Food Packaging Suitable for the Circular Economy: Cleanliness is Next to Godliness

Elliot Woolley<sup>1</sup>  , Mala Sian<sup>1</sup>, Samsun Nahar<sup>1</sup> , Nikki Clark<sup>2</sup> ,  
Fiona L. Hatton<sup>3</sup> , Ryan Larder<sup>3</sup> , Rhoda Trimmingham<sup>2</sup>, and Garrath T. Wilson<sup>2</sup> 

<sup>1</sup> Electrical and Manufacturing Engineering, Wolfson School of Mechanical, Loughborough University, Leicestershire LE11 3TU, UK

e.b.woolley@lboro.ac.uk

<sup>2</sup> School of Design and Creative Arts, Loughborough University, Leicestershire LE11 3TU, UK

<sup>3</sup> Department of Materials, Loughborough University, Leicestershire LE11 3TU, UK

**Abstract.** Single use plastic packaging and its environmental impacts have received much attention over the last few years from governments, businesses and consumers. One option to reduce plastic packaging waste and its associated environmental impacts is to shift towards circular business models, supplying reusable packaging options that are used many times before being recycled. One technical barrier to the implementation of plastic food packaging reuse is the need to effectively clean the packs and provide cleaning assurance to prevent the possibility of product crossover. This research investigated the feasibility of using Ultraviolet Fluorescence imaging to optically detect residual food fouling and thus assuring cleanliness in the case example of margarine spread tubs. Processing of obtained images was carried out using MATLAB® applying Otsu's thresholding method. It was established that for the current setup the minimum detectable quantity of fouling was of the order  $10^{-4}$  g/mm<sup>2</sup>. The assessment process was correlated against that of Adenosine Triphosphate assay, an industry-standard process for assessing the cleanliness of food contact surfaces. The implications of the investigated technique overcome one barrier to plastic food packaging reuse on an industrial scale. Fast and reliable fouling evaluation of every pack will underpin business and consumer trust in such a circular material flow. The established technique has the potential to form part of the wider reuse system for polymer packaging. Implications on optical detection optimization, packaging design, and suitability for automation are discussed alongside wider food supply chain considerations.

**Keywords:** Plastic waste · Product reuse · Circular supply chains · Quality assurance · Ultraviolet fluorescence imaging · Optical sensors

## 1 Introduction

Polymers are an extremely versatile range of materials and have become almost ubiquitous in life of much of the world's population. Its low cost, high strength, longevity and manipulability make it a primary choice for many applications. However, plastic waste

© The Author(s) 2023

H. Kohl et al. (Eds.): GCSM 2022, LNME, pp. 231–239, 2023.

[https://doi.org/10.1007/978-3-031-28839-5\\_26](https://doi.org/10.1007/978-3-031-28839-5_26)



has become one of the most recognized and maligned environmental impacts associated with modern consumerism and has led to a range of policies designed to reduce plastics manufacture and use (e.g. [1, 2]).

Plastic packaging represents a substantial challenge to be addressed; it is responsible for over a quarter of all plastics produced globally [3], and has a short use cycle, after which 95% of its value is lost. Although recycling is an option to retain some of the material value, the European Union has estimated that at end-of-life, less than 30% of plastic waste is recycled, 31% goes to landfill and 39% is incinerated [4] whilst other studies have reported average recycling rates as low as 20% [5]. Resources dedicated to plastics production, transport miles and residual utility are also effectively lost from premature disposal. Within the UK alone, some 2.3 Mt of plastics are used for packaging each year, of which almost 0.5 Mt are consumer pots, tubs and trays (PTT) [6] which are often used to package food products.

An option to reduce plastic waste and its associated environmental impacts is to enable and promote the reuse of polymer products. For the food packaging industry, this requires the need for new circular business models and supply chains, including reverse logistics, cleaning, cleanliness and quality assurance, and both supply chain and consumer incentives [7]. Establishing a circular economy where packaging is returned at its end-of-use, cleaned, and then refilled with new product for resale could provide a solution to resource use and waste production. Food packaging reuse systems already exist (e.g. Loop, Modern Milkman) but packaging materials are typically limited to aluminum and glass. For any reuse system to work for packaging, it is essential to have effective cleaning and quality assurance processes in place.

One technical barrier to the implementation for the circularity of plastic food packaging is the need to effectively clean the packs and provide cleaning assurance to prevent the possibility of product crossover. Such cross-contamination between uses presents the hazard of foodborne illness to consumers which would seriously undermine any potential environmental benefits from such a system. Despite the importance of the cleaning stage, suitable standards, and guidance for cleaning of reusable packing is currently non-existent. It is perhaps difficult to provide such guidance for polymer-based packaging since oft-recommended sanitizing rinse temperatures for food contact surfaces are typically above 70 °C, which is very near the glass transition temperature of polyethylene terephthalate (PET) and hence may lead to material warping, for example. Also, the added complexity of circular use systems means it could be more difficult to track and control outbreaks of contamination and hence recall dangerous products [8].

The research presented in this paper investigated the feasibility of using ultraviolet (UV) fluorescence imaging to optically detect residual food fouling and thus assuring cleanliness in the case example of margarine tubs. The technique has previously been demonstrated for other food contact surfaces [9], but not for polymer packaging. The paper justifies the use of subject materials before describing the physical and procedural experimental design. Importantly the optical illumination, image capture and image processing are detailed and the results processed and analyzed to provide contextual importance. The optical results are compared against those obtained via an adenosine triphosphate (ATP) swab technique to demonstrate suitability of the process. The UV

detection technique is discussed in the context of industrial application within a system for a circular economy for plastic food packaging.

## 2 Methods and Materials

Within this study two stages of investigation were undertaken to determine, under controlled conditions, the feasibility of using UV fluorescence to detect margarine-like spread fouling on polypropylene (PP) surfaces. The objective was to determine the lowest level of residual fouling that could be detected and to compare this with industrial standards.

### 2.1 Testing Regime and Sample Preparation

The subject of the studies in this research was Flora® spread, a margarine-type product, retailed in the UK, across Europe and worldwide. Margarine contains ample fluorophores that under suitable excitation of UV light, fluoresce in the green part of the electromagnetic spectrum (~500 to 570 nm) and hence can be imaged. Primarily supplied in PP tubs, the spread was used as an example product that has a high-fat content making it difficult to clean from surfaces and could potentially be supplied in refillable packs. Notably, PP has an advantage for reusable packaging over the more common polyethylene terephthalate (PET) in that it is more resilient to high temperatures required for cleaning.

#### Critical Detection

The first test conducted sought to determine the critical (minimum) quantity of food residue detectable on a PP substrate. Different dilutions of Flora® spread were created by mixing via agitation with water within beakers placed over a warm water bath. Dilutions were prepared according to those described in Table 1. Using a micropipette, 1 ml of dilution was evenly distributed over a 30 mm diameter test area on uncoloured PP slides of dimension 50 × 50 mm. Samples were left to completely dry in the laboratory ambient atmosphere (typically overnight) before being imaged.

#### On-Pack Detection

Assessment of fouling levels on an actual pack form was undertaken to determine the suitability of the system for a more realistic assessment scenario. Empty Flora® 500 g PP tubs were utilised in this study. Before each sample preparation, tubs were cleaned manually using detergent and warm water before being rinsed and dried. The inner base and walls of the tubs were individually fouled with 5.0 g, 1.0 g and 0.5 g of Flora® taken from a melted sample and manually distributed near-evenly using a spatula: to provide more realistic distribution of fouling, homogenous distribution was not intended in this study.

**Table 1.** Solution concentrations investigated. Spread density assumed to be 0.96 g/ml.

Sample	Mass of spread (g)	Quantity of distilled water (ml)	Mass of spread per 1 ml of solution (g)	Distribution of deposited spread ( $\text{g mm}^{-2}$ )
A	5.0	14.1	0.259	$3.66 \times 10^{-4}$
B	5.0	23.6	0.174	$2.45 \times 10^{-4}$
C	5.0	35.4	0.123	$1.74 \times 10^{-4}$
D	1.0	14.1	0.066	$9.34 \times 10^{-5}$
E	1.0	28.3	0.034	$4.82 \times 10^{-5}$

## 2.2 Image Acquisition and Processing, and ATP Assay

An optically isolated stainless-steel box was utilized to allow a controlled experimental campaign of digital image acquisition under excitation by UV light, provided via a dual 18W 370nm (nominal) fluorescent lamp (UV18W BLDTU, UV Light Technology Limited, UK). Image acquisition utilised a Basler® (Germany) ace acA1920-150uc 2-megapixel (MP) camera. The camera was mounted in a bespoke holder outside the stainless-steel box at an aperture to ensure stability and positioning. Focus and lens aperture were manually adjusted to optimize image clarity. Once selected, these settings remained constant for the duration of investigation.

Captured images were processed using MATLAB®. The acquired red-green-blue (RGB) image appears as a 2 MP image x 3 elements matrix, where the third dimension represents the three colour channels red, green and blue respectively. Fluorescing fouling appears as a cyan coloured object within the image and can be isolated by extracting the green channel yielding a 2 MP image represented in greyscale.

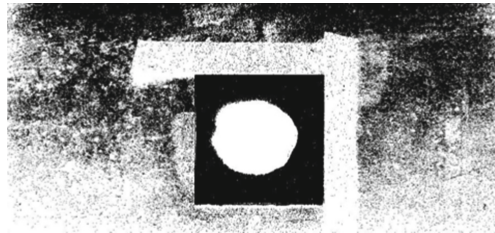
To distinguish fouling from non-fouled areas, thresholding is required. For this stage, Otsu's method [10] was investigated and implemented using the *'multithresh'* function in MATLAB® (MathWorks®, 2021). Otsu's thresholding method assumes the pixel intensities follow a bi-modal distribution and defines the threshold by minimizing the variance of the values within each of the two classes of pixels it defines. In doing so, the variance between the two classes is maximized [11] are referred to as 'positive' and 'negative' classifications respectively. Generally and ideally, the number of pixels in the positive area of the image define the amount of detected fouling.

For comparison against an industrially relevant assessment process diluted fouling samples were also assessed using an ATP swab test method (Hygiena® SystemSURE® Plus™ luminometer with UltraSnap® swab). For laboratory practice reasons, separate samples to those investigated via UV fluorescence were prepared for ATP assay albeit with slightly varying dilutions of fouling, but this does not hinder comparison between the techniques. ATP assay is considered the best available technique routinely used in the food industry for evaluating food contact surfaces. Manufacturers guidance for the ATP swabs used recommend a  $100 \times 100$  mm swab area but this was not possible for the concentration studies due to the sample size. In these cases the full slide was swabbed. As recommended by the Hygiena®, swabs were removed from the refrigerator 10 min before being used. For the particular ATP device used the measurement range is 0–9999

RLU (relative light units). A reading of 30 or above is classed as a fail (i.e. unacceptably fouled).

### 3 Results

For the majority of samples, the image process provided a clear indication of the location of fouling, however noise in the visible part of the spectrum from the reflected illumination source on the base of the dark box made it difficult for the thresholding procedure to differentiate the true fouling from this background signal (see Fig. 1). To address this, images were manually cropped at the border of the sample slide to disregard any area that was not under direct consideration.



**Fig. 1.** Thresholded image of sample C. The base of the dark box provides false positive pixels.

The number of pixels identified through image processing as fouling is shown in Table 2 in comparison to the deposited fouling concentration. The threshold required to differentiate the fouled area from the background was significantly lower for the dilute concentrations (i.e.  $9.34 \times 10^{-5}$  and  $4.82 \times 10^{-5}$ ) and hence the increased pixel count for the positive regions in these images indicate the difficulty in distinguishing the fouled area from the background noise on the substrate. Hence it is found that the minimum detectable quantity of fouling for this setup and using this image processing procedure lies between  $1.74 \times 10^{-4}$  and  $9.34 \times 10^{-5}$  g/mm<sup>2</sup>.

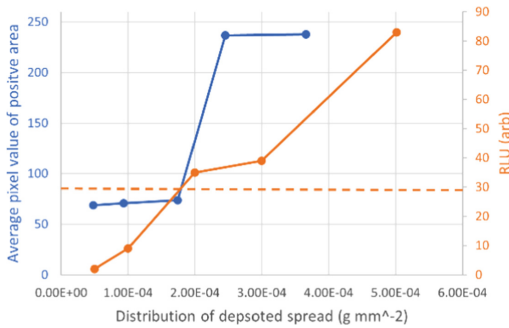
The average intensity of the pixels in the positive region of the images also indicates a good sensitivity to concentrations as low as  $1.74 \times 10^{-4}$  g/mm<sup>2</sup> (Fig. 2) whilst the low intensities of more dilute fouling suggests the inability of the detection system to reliably differentiate those areas from background noise.

Figure 2 also shows the result of ATP assay for the fouling samples prepared over a similar range of dilutions. In this investigation assessment of fouling via ATP swabbing yields a more gradual relationship with respect to the fouling level and hence could be perceived to be more reliable. However, although not proven conclusively here, the optical detection approach appears to be able to detect fouled/non-fouled regions to the degree required to determine if a surface is ‘clean enough’: a reading of 29 RLU from the ATP assay. Of course, a significant advantage of the optical technique is that it is a non-contact assessment, has no real operational cost and could be performed at high speed in a continuous production environment, unlike ATP assay.

The thresholded images of the PP pack fouled with varying amounts of Flora® spread (Fig. 3) have falsely categorized the inside of the dark box (corners of images)

**Table 2.** Numerical output of image processing for investigated fouling dilutions

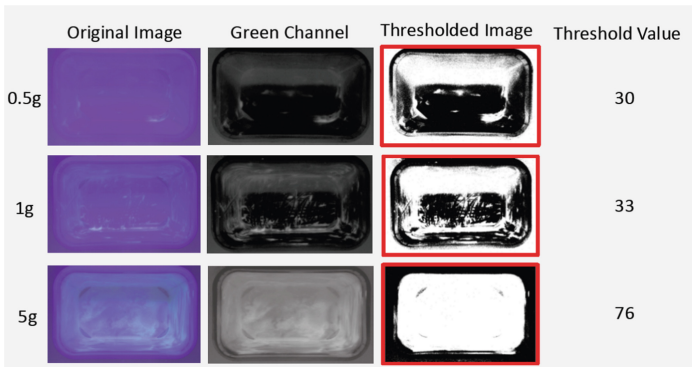
Distribution of deposited spread (g mm <sup>-2</sup> )	No pixels in positive area	Threshold value from Otsu’s method
$3.66 \times 10^{-4}$	79707	140
$2.45 \times 10^{-4}$	73340	138
$1.74 \times 10^{-4}$	71348	129
$9.34 \times 10^{-5}$	345520	42
$4.82 \times 10^{-5}$	341955	47



**Fig. 2.** The average pixel intensity (blue) from optical processing and ATP response (orange) for a range of Flora® spread dilutions on PP. The orange dashed line represents the pass threshold for ATP assay. The pixel value axis has been scaled to pass the ATP threshold at a similar location to the ATP response for more realistic comparison.

as positive for the 1.0 g and 0.5 g fouling levels. This poses the possibility that other areas within the tub may also be categorized as false positives. The tub fouled with 5.0 g of spread shows a more realistic representation of the fouled area in the image but contains negatively classified areas at the corners of the tub base. These are locations where no external printing is present on the semi-transparent polymer. Hence the colour and opacity of the packaging influences the detectability of the fluorescence from the fouling.

Another pertinent observation from the processed images in Fig. 3 is the impact of shadowing on fluorescence of fouling. In the described experimental setup, the camera is positioned directly above the pack forms, but the illumination is offset causing darker regions on one of the longer edges of each tub. Variation in illumination intensity makes a significant difference to the signal obtained from different areas of a fouled surface. The issue is likely to be complicated further by the increased complexity of the pack form. For example, the lids of Flora® tubs, which fasten via an interference fit, have an overhang which makes line-of-sight difficult for optical imaging.



**Fig. 3.** Raw and processed images obtained from investigating on-pack fouling.

## 4 Concluding Discussion

A new application of UV fluorescence imaging has been demonstrated to be a potentially suitable technique for the application of cleaning assurance for reusable PP food packaging. In its current form the technique performs to a degree of accuracy commensurate with that of the industry standard for food contact surfaces, ATP assay, albeit the potential for some conditions to lead to false classifications needs to be better understood. The optical detection technique has distinct advantages over ATP assay in that it is rapid, non-contact (hence does not contaminate the surface), has negligible operational costs and does not produce consumable waste (swabs). There are however several potential improvements that should be made to improve sensitivity, reliability and suitability for direct industrial application.

On the one hand, improvements to the detection system such as increased and more homogeneous light intensity could yield improved images, as could a detection system with improved quantum efficiency (for the current camera this is 54%) and filtering to improve signal-to-noise. In terms of image processing Otsu's thresholding method is highly sensitive to distributions of intensities and hence it is possible to fail to detect small areas or low levels of fouling. A two-stage process may be better: rapid detection for obvious fouling, then a different process, for example hysteresis thresholding, to detect lower levels of fouling. Intelligent definition of the region of interest to determine the location and orientation of packs would remove the likelihood of false positive classification from irrelevant areas of the image.

With respect to packaging design to support detection of cleaning success (and also improve the cleaning process), complex geometries, particularly partially enclosed spaces and tight corners, should be avoided. Wide and shallow containers with low draft angles are preferable for improved visibility and to support more uniform illumination. These practices should be shared across all packaging suppliers and indeed the Ellen MacArthur Foundation [12] has suggested that reusable packaging should be standardized to allow for better system design and reliability.

A circular system for polymer packaging is a potential solution to plastic consumption but demands changes to current industrial supply chains. Packaging manufacturers

would need to become packaging system providers, onboarding reverse logistics, cleaning, and quality assurance processes. The cleanliness assurance method investigated in this work, although not fully developed, indicates that it could form part of the technological solution to reusable plastic packaging. Increasing assurance of food safety is likely to remove one barrier to consumer and industrial acceptance of such a radical and beneficial transition.

## References

1. WRAP, The UK Plastics Pack Report 2018/19 (2019). <https://archive.wrap.org.uk/sites/files/wrap/The-UK-Plastics-Pact-report-18-19.pdf>. Accessed 13 May 2022
2. UNEP, End plastic pollution: Towards an international legally binding instrument, United Nations Environment Programme, UNEP EP/EA.5/L.23/Rev.1. (2022)
3. Ellen MacArthur Foundation, The New Plastics Economy, Rethinking The Future of Plastics, (2016). [https://www.mckinsey.com/~media/McKinsey/dotcom/client\\_service/Sustainability/PDFs/The%20New%20Plastics%20Economy.ashx](https://www.mckinsey.com/~media/McKinsey/dotcom/client_service/Sustainability/PDFs/The%20New%20Plastics%20Economy.ashx). Accessed 13 May 2022
4. European Commission, A European Strategy For Plastics In A Circular Economy. 1st ed. (2018) Brussels: European Commission. [https://eur-lex.europa.eu/resource.html?uri=cellar:e0649735-a372-11eb-9585-01aa75ed71a1.0001.02/DOC\\_1&format=PDF](https://eur-lex.europa.eu/resource.html?uri=cellar:e0649735-a372-11eb-9585-01aa75ed71a1.0001.02/DOC_1&format=PDF). Accessed 23 Apr 2022
5. OECD, Improving Markets for Recycled Plastics – Trends, Prospects and Policy Responses, OECD Publishing, Paris, (2018)
6. Statista, Plastic Waste in the UK, Statista, did-51904–1, (2018)
7. Wilson, G.T., Clark, N., Hatton, F.L., Trimmingham, R., Woolley, E.: Perpetual plastic for food to go: a design-led approach to polymer research. *Polym. Int.* **71**(12), 1370–1375 (2022)
8. McDowell, D.A., Food hygiene challenges in replacing single use food service ware with reusable food service items, (2020). <https://www.eppa-eu.org/uploads/Bestanden/FINAL%20EPPA%20Report%20-%20Professor%20David%20McDowell.pdf>. Accessed 22 July 2021
9. Simeone, A., Deng, B., Watson, N., Woolley, E.: Enhanced clean-in-place monitoring using ultraviolet induced fluorescence and neural networks. *Sensors* **18**(11), 3742 (2018)
10. Otsu, N.A.: Threshold selection method from Gray-level histograms. *IEEE Trans. Syst. Man. Cybern.* **9**, 62–66 (1979)
11. Carabias, D., Analysis of image thresholding methods for their application to augmented reality environments ePrints (2012). [https://eprints.ucm.es/id/eprint%20/16932/1/Tesis\\_Mas\\_ter\\_Daniel\\_Martin\\_Carabias.pdf](https://eprints.ucm.es/id/eprint%20/16932/1/Tesis_Mas_ter_Daniel_Martin_Carabias.pdf). Accessed 13 May 2022
12. Ellen MacArthur Foundation Reuse Rethinking Packaging (2019). <https://www.ellenmacarthurfoundation.org/assets/downloads/Reuse.pdf>. Accessed 04 May 2022

**Open Access** This chapter is licensed under the terms of the Creative Commons Attribution 4.0 International License (<http://creativecommons.org/licenses/by/4.0/>), which permits use, sharing, adaptation, distribution and reproduction in any medium or format, as long as you give appropriate credit to the original author(s) and the source, provide a link to the Creative Commons license and indicate if changes were made.

The images or other third party material in this chapter are included in the chapter's Creative Commons license, unless indicated otherwise in a credit line to the material. If material is not included in the chapter's Creative Commons license and your intended use is not permitted by statutory regulation or exceeds the permitted use, you will need to obtain permission directly from the copyright holder.







# CO<sub>2</sub> Footprint of Machine Elements Made of Fiber-Reinforced Polymer Concrete Compared to Steel Components

Kim Torben Werkle<sup>(✉)</sup>, Michelle Engert, and Hans-Christian Möhring

Institute for Machine Tools, University of Stuttgart, Holzgartenstr. 17, 70174 Stuttgart, Germany  
kim.werkle@ifw.uni-stuttgart.de

**Abstract.** Energy efficiency and resource economizing are the drivers for the development of new types of material-hybrid design approaches for machine tools. Polymer concrete has been used for machine beds in machine tool design for many years. The good thermal and dynamic properties of the material are particularly convincing in this context. The good damping properties for structural components are also interesting, as this reduces for example tool wear and at the same time the high damping compared to steel structures has a positive effect on the surface quality of the machined workpiece. Current research in the field of structural dynamics is dealing with the substitution of steel and cast components with hybrid, actively preloaded polymer concrete parts. This allows the use of the positive damping properties of polymer concrete and the positive tensile strengths of the integrated fiber-reinforced structures for dynamically loaded machine components such as machine arms or machine stands. The focus of the study is to replace the arm of a bed-type milling machine, which is currently a welded design, with a component made of prestressed carbon fiber-reinforced polymer concrete. Based on the first results of the volume ratios of the structures, conclusions are drawn about the life cycle assessment (cradle to gate) of the components. The results will contribute to a design recommendation for the carbon fiber reinforcement in the polymer concrete arm to achieve a better structural efficiency on the one hand and a better life cycle assessment on the other.

**Keywords:** CO<sub>2</sub> emission · Composite materials · Design optimization

## 1 Advantages and Disadvantages of Polymer Concrete for Machine Elements

The selection of materials used in machine tool design is always based on the occurring load collectives. This is especially true for approaches to structural optimization, which aim to reduce the component mass while optimizing stiffness but should not change the basic properties of the component. Because of its properties, such as very good damping and low thermal expansion [1], polymer concrete offers the best prerequisites for use as a material for highly stressed components in machine tools. Polymer concrete, also known as mineral cast or reactive resin concrete, is a composite material consisting of

inorganic mineral filler particles and stone particles (quartz, granite, basalt) of up to 93% by volume and a binder, mostly epoxy resin or unsaturated polyester resin, of approx. 10% by volume [2, 3]. In moving components or structures that are exposed to high, possibly even alternating loads, especially in tension or bending, mineral casting quickly reaches the load limit [3]. But the properties of polymer concrete are dependent on several criteria: Binder, mineral aggregates, type of reinforcement and mass proportions of the individual components.

The chosen approach aims at the development of methods for prestressing such polymer concrete components with the help of textile reinforcement structures, in order to be able to permanently withstand occurring tensile loads. The enormous potential of high-performance fibers, which are successfully used in conventional plastic composites, has not yet been systematically exploited in polymer concrete. Nevertheless, fiber reinforcement is not a fundamentally new concept: fibers made of glass and carbon [4, 5], have already been used in the form of filler material or as reinforcement bars [6] with a low volume fraction.

In addition, it has been shown that the use of polymer concrete also offers advantages regarding the mass of components due to its lower density and thus has a direct influence on the energy required to move the components through lightweight design approaches [7]. The tensile strength of the material, however, is too low for use in places that are exposed to high and changing loads. Therefore, a hybrid approach of mineral casting and carbon fibers can be a target-oriented solution in lightweight design for machine tools. This opens new application possibilities for mineral casting in machine tool design and a step forward in the development of a general reduction of CO<sub>2</sub> emissions in manufacturing and the use of machine tools. Within the scope of this paper, a first investigation of the substitution of a welded steel boom against a carbon fibre-reinforced polymer concrete boom is examined regarding the CO<sub>2</sub> balance in the manufacturing process of the components. Based on an estimation of the volume-% of the different ingredients, the advantages, and disadvantages of fibre-reinforced polymer concrete with regard to CO<sub>2</sub> savings are discussed.

## **2 Optimization of the Machine Component “Extension Arm” Through Topology-Optimized Fiber-Reinforced Polymer Concrete**

In this example, the extension arm of a machine in console bed design is considered. The extension arm currently consists of welded 4-sided steel tubes with a total weight of 28 kg. The steel framework is mounted on the movable frame and the spindle via two 20 mm thick flange plates. Figure 1 shows the current structure of the machine. The load spectrum used as a boundary condition for the redesign of the machine cantilever is based on a pocket milling process in aluminium AlMg<sub>1</sub>. According to Victor-Kienzle, a cutting force  $F_c$  of 1318 N results for a cutting depth  $a_e$  of 12 mm with full engagement of an end mill with 8 mm diameter and 3 cutting edges. A total force of 2000 N is assumed as a safety factor for the further design. The resulting moments  $M_1$  and  $M_2$  are time-variable depending on the force application vector and are applied in the FE simulation over several load steps.

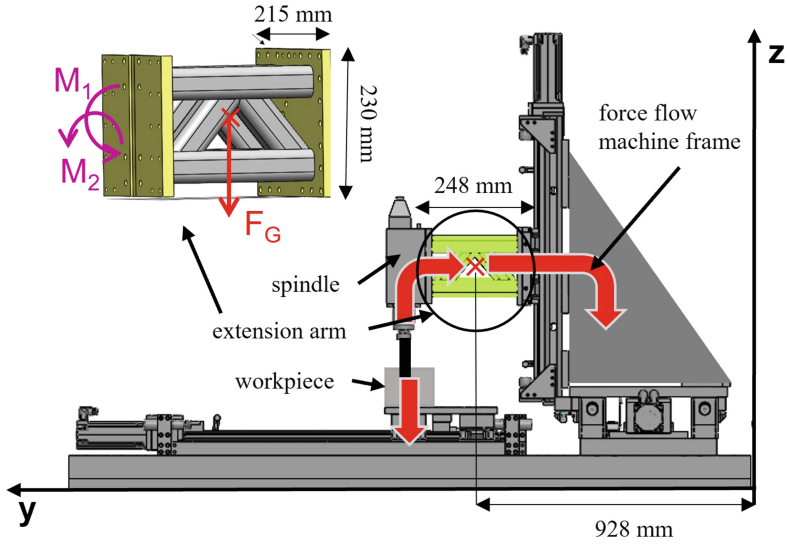


Fig. 1. Force directions of a machine arm in a machine tool in console bed design

The integration of the estimated possible damping constants via harmonic analysis is used as a further boundary condition for the design of the machine component. To achieve the general goal of minimizing the compliance of the system component, a topology optimization of the extension arm is carried out. The material-specific parameters for the analysis were taken from the manufacturer’s specifications of Rampf EPUMENT 130/3 A3 as well as the carbon fibers of the manufacturer Mitsubishi Chemical Carbon Fiber and Composites - GRAFIL 34–700.

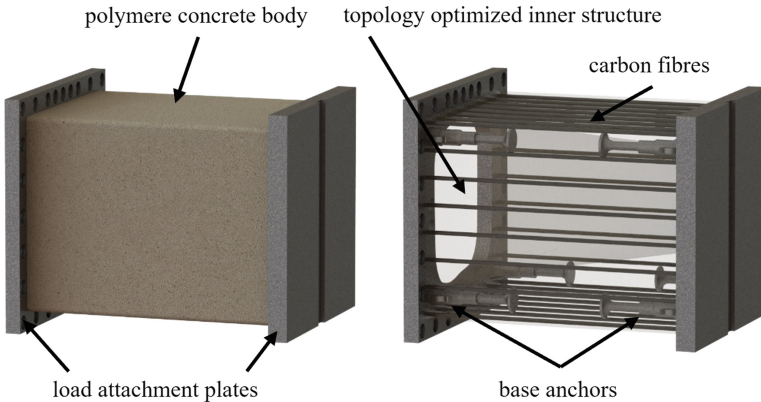
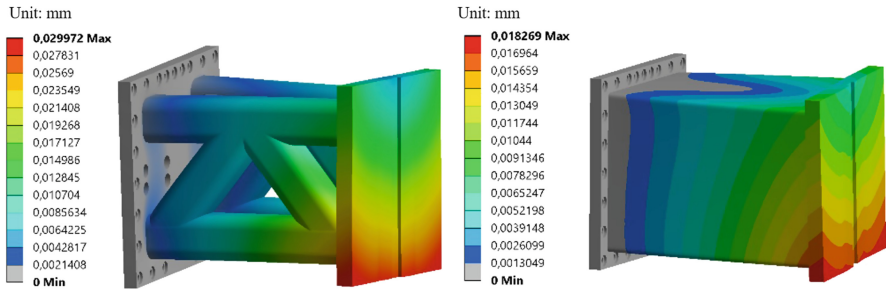


Fig. 2. Topology-optimized, fiber-reinforced machine extension arm

By analyzing the resulting force paths, it is possible to pre-tension the Carbon fibers in the loaded direction. Figure 2 shows the results of topology optimization and weight

minimization with a Carbon fiber content of only 1.58%. With a total weight of the polymer concrete extension arm of 23.33 kg, this corresponds to a total fiber weight of 368 g divided into 28 fiber bundles. Figure 3 shows a comparison of the results of the maximum displacement of the steel extension arm compared to the reinforced polymer concrete extension arm. The optimized fiber-reinforced polymer concrete arm has a 60% lower displacement under load than the steel body.



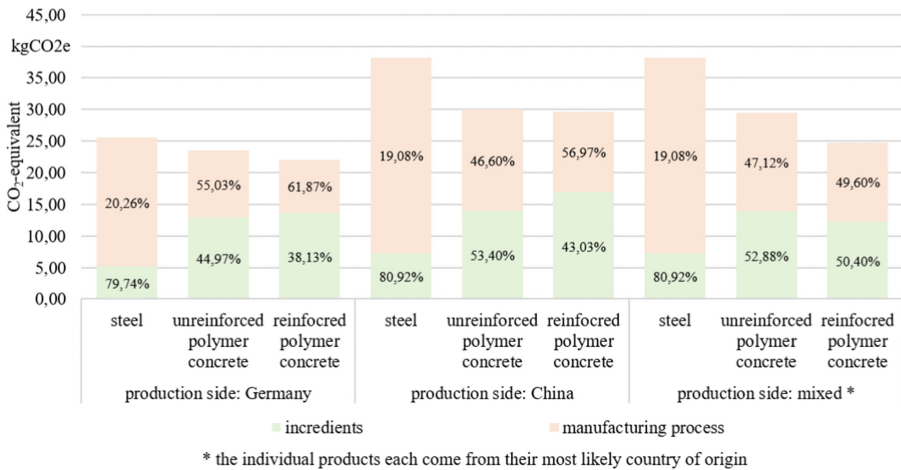
**Fig. 3.** Displacement of the steel extension arm on the left and the prestressed polymer extension arm on the right when loaded in negative x-direction during pocket milling

With the objective of making the manufacturing of a polymer concrete arm even more efficient, the amount of carbon fibers was reduced further in a second step. With an average value of 15, 5 kgCO<sub>2</sub>e/kg, carbon fibers cause very high CO<sub>2</sub> emissions in their manufacturing process. With the help of a parameter study, the used amount of carbon fibers was reduced until the polymer concrete extension arm achieves the same theoretical compliance as the steel extension arm. This reduced the volume of fibers to 0.58%, corresponding to 135 g of carbon fibers. For further consideration of the CO<sub>2</sub> footprint, the calculated mass proportions of the steel extension arm, a polymer concrete extension arm without carbon fibers and the structurally optimized polymer concrete extension arm with carbon fibers are summarized in Table 1.

**Table 1.** Overview of the mass ratios of the extension arms

	steel extension arm	polymer concrete extension arm	fiber-reinforced polymer concrete extension arm
steel	27,86 kg	13,40 kg	10,80 kg
polymer concrete	-	16,35 kg	12,40 kg
carbon fibers	-	-	0,13 kg
total weight	27,86 kg	29,75 kg	23,33 kg

### 3 Carbon Footprint Analysis



**Fig. 4.** Carbon footprint of steel, polymer concrete and fiber-reinforced polymer concrete extension arms by country of production

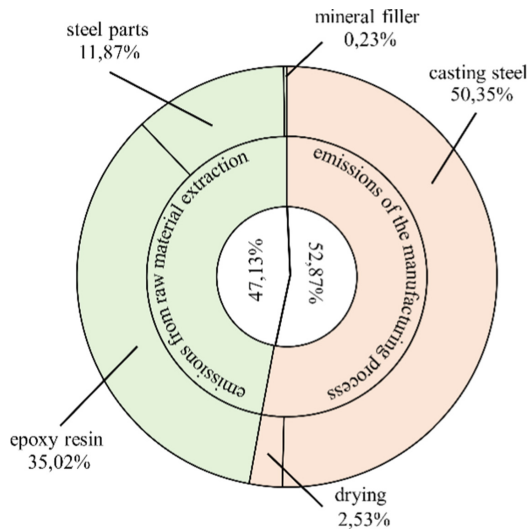
To compare the three components, a carbon footprint calculation was carried out (cf. Fig. 4). The results show that in all cases the manufacturing of the raw materials of steel cause lower CO<sub>2</sub> emissions than those of polymer concrete. The manufacturing process of steel, however, causes high CO<sub>2</sub> emissions due to the required high energy input [8]. Polymer concrete is advantageous here due to its low primary energy demand and can thus reduce CO<sub>2</sub> emissions by up to 35%.

For all extension arms, Germany as a production site shows itself to be the most favourable regarding the CO<sub>2</sub> footprint, especially for the steel arm. In this case, the CO<sub>2</sub> footprint of the steel arm is with 25.57 kgCO<sub>2</sub>e only 9% higher than the extension arm made of unreinforced polymer concrete and 15% higher than the fiber-reinforced polymer concrete.

Due to its high energy-related CO<sub>2</sub> emissions of 555 gCO<sub>2</sub> /kWh [8] (compared to 366 gCO<sub>2</sub>/kWh in Germany [9]), China is the most unfavorable production site for all versions of the extension arms. For the steel extension arm, there is a 49% increase in the CO<sub>2</sub> emissions compared to the manufacturing site in Germany. The extension arm made of fiber-reinforced polymer concrete shows an increase of 34% and achieves almost the same CO<sub>2</sub> balance for the production site China as the heavy extension arm made of solid polymer concrete.

For a realistic comparison of the three components, the most likely countries of origin are determined for all individual parts. It turns out that China is the largest supplier of steel products [10], and the USA is the main supplier of carbon fibers with a market share of 30% [11]. Following manufacturers' information, Germany assumed to be the production location for polymer concrete [8]. When comparing the extension arms under these assumptions, the arm made of fiber-reinforced polymer concrete has the best CO<sub>2</sub> balance with 24.82 kgCO<sub>2</sub>e. The steel extension arm achieves the highest CO<sub>2</sub> emissions with 38.2 kgCO<sub>2</sub>e. It is shown that the use of fiber-reinforced polymer concrete as a material for the extension arm can reduce CO<sub>2</sub> emissions by up to 35% compared to steel.

In the following, the CO<sub>2</sub> emissions of the extension arms made of unreinforced polymer concrete in Fig. 5 and fiber-reinforced polymer concrete in Fig. 6 will be analyzed in more detail, assuming a mixed country of origin.



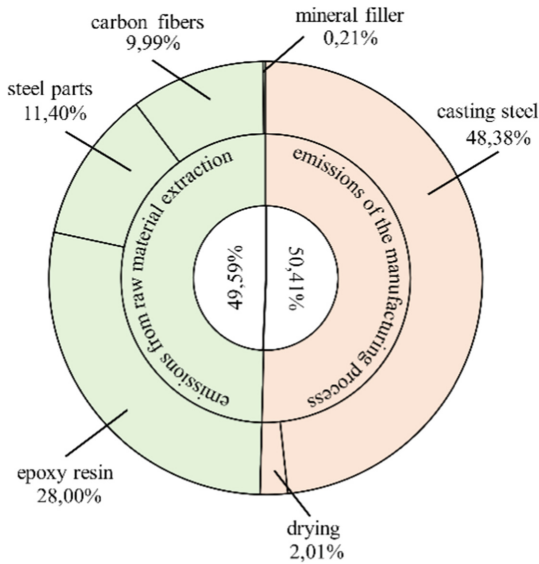
**Fig. 5.** Carbon footprint composition of an extension arm made of polymer concrete (production country: Germany, production country for the steel parts: China)

For the polymer concrete extension arm (Fig. 5), 53% of the carbon dioxide emitted can be attributed to the manufacturing process. The casting of the integrated steel parts is the largest part of this process (95%). This also represents the largest part of the overall balance. Other items are the drying of the minerals and the mixing of minerals, resin and hardener. The casting process does not produce any CO<sub>2</sub> emissions.

A look at the CO<sub>2</sub> balance of the ingredients shows that the epoxy resin provides the largest share here. The steel parts represent the second largest share. The mineral fillers contribute only slightly to the overall balance with 0.07 kgCO<sub>2</sub>e.

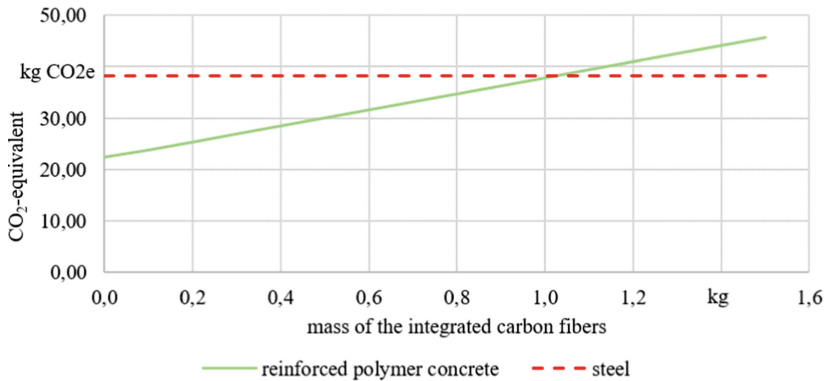
The carbon footprint for the fiber-reinforced polymer concrete extension arm in Fig. 6 is made up almost equally of the carbon dioxide produced in the manufacturing process and the carbon dioxide produced in the production of the ingredients. Like with the unreinforced extension arm, the production of the steel parts represents the largest share.

Among the ingredients, epoxy resin is again the largest component in the CO<sub>2</sub> footprint. With a mass share of 4.4%, it accounts for over 50% of the ingredient-related greenhouse gas balance. The mass-related CO<sub>2</sub> equivalent for the material is 5.9 kgCO<sub>2</sub>e/kg. Among the materials considered here, only carbon fibers have a higher mass-related CO<sub>2</sub> equivalent of 15.5 kgCO<sub>2</sub>e/kg.



**Fig. 6.** Carbon footprint composition of a extension arm made of fiber-reinforced polymer concrete (production site: Germany, production site for the steel parts: China, production site for the carbon fibres: USA)

If the aim in the design of the extension arm made of fiber-reinforced polymer concrete is to achieve a better CO<sub>2</sub> balance than with the steel extension arm, the maximum quantity of carbon fibers is limited due to the high mass-related CO<sub>2</sub> equivalent. As Fig. 7 shows, the extension arm made of fiber-reinforced polymer concrete achieves with a mass of 1.02 kg of carbon fibers the same CO<sub>2</sub> balance as the steel arm.



**Fig. 7.** CO<sub>2</sub>-equivalent of the extension arm made of fiber reinforced polymer concrete depending on the mass of carbon fibers compared to the CO<sub>2</sub>-equivalent of the steel extension arm

## 4 Conclusion

In this paper, it was shown that replacing a steel extension arm with a fiber-reinforced polymer concrete arm can improve the carbon footprint in the manufacture of machine tools while maintaining the same or even a better compliance. It was also shown that adding more carbon fibers can further improve the mechanical properties of the fiber-reinforced extension arm. As long as the mass of the carbon fibers remains below 1.02 kg (4, 2% of the total weight), the carbon footprint of the extension arm is 34% better than the steel extension arm.

## References

1. Putz, M., Ihlenfeldt, S., Wittstock, V., Regel, J., Richter, C., Noffke, F.: Auswirkungen lokaler Erwärmung von Mineralguss. *wt Werkstatttechnik online*, Jahrgang **104**(9), 602–607 (2014)
2. Jackisch, U.-V.: *Mineralguss für den Maschinenbau: Herstellung und Eigenschaften eines modernen Werkstoffs für hochpräzise Maschinengestelle*. Verlag Moderne Industrie (2002)
3. Möhring, H.-C., Brecher, C., Abele, E., Fleischer, J., Bleicher, F.: Materials in machine tool structures. *CIRP Ann. Manuf. Technol.* **64**, 725–748 (2015)
4. dos Reis, J.M.L.: Fracture toughness of fiber reinforced polymer concrete. In: Marcílio, A., da Costa Mattos, H.S. (eds.) *ABCM Symposium series in solid mechanics – Mechanics of Solids in Brazil 2007*, vol. 1. Brazilian Society of Mechanical Sciences and Engineering (2007). ISBN 978-85-85769-30-7, <https://doi.org/10.13140/2.1.3743.7760>
5. dos Reis, J.M.L.: Mechanical characterization of fiber reinforced polymer concrete. *Mater. Res.* **8**(3) (2005). ISSN 1516–1439, <https://doi.org/10.1590/S1516-14392005000300023>
6. Tavares, C.M.L.; Ribeiro, M.C.S.; Ferreira, A.J.M.; Guedes, R.M.: Creep behaviour of FRP-reinforced polymer concrete. *Compos. Struct.* **57**(1–4), 47–51 (2002), ISSN 0263–8223, [https://doi.org/10.1016/S0263-8223\(02\)00061-2](https://doi.org/10.1016/S0263-8223(02)00061-2)
7. Misch, S., Nguyen, L.T., Möhring, H.-C.: Grading curve of hollow sphere composites. In: *5th Cellular Materials CellMAT 2018*, Bad Staffelstein, Germany, 24–26 October 2018
8. *Developmentscout – Online Magazin für industrielle Konstruktion und Entwicklung: Niedrigenergieproduktion von schwingungsdämpfenden Maschinenbetten* (2020). <https://www.developmentscout.com>



- [developmentscout.com/industrie/werkstoffe-verfahren/3d-druck/9563-niedrigenergieproduktion-von-schwingungsaempfindenden-maschinenbetten-und-gestellbauteilen](https://developmentscout.com/industrie/werkstoffe-verfahren/3d-druck/9563-niedrigenergieproduktion-von-schwingungsaempfindenden-maschinenbetten-und-gestellbauteilen). Accessed 27 Apr 2022
9. Kejun, J.: Brown to Green: The G20 transition towards a net-zero emissions economy, China (2019)
  10. Statistisches Bundesamt: Jährliche Produktionskapazität von Kohlenstofffasern nach Ländern weltweit im Jahr 2018. <https://de.statista.com/statistik/daten/studie/660034/umfrage/produktionskapazitaet-von-kohlenstofffasern-nach-laendern/>. Accessed 27 Apr 2022
  11. Statistisches Bundesamt: Entwicklung des CO<sub>2</sub>-Emissionsfaktors für den Strommix in Deutschland in den Jahren 1990 bis 2020. <https://de.statista.com/statistik/daten/studie/38897/umfrage/co2-emissionsfaktor-fuer-den-strommix-in-deutschland-seit-1990/>. Accessed 27 Apr 2022
  12. Statistisches Bundesamt: Wichtigste Länder weltweit nach Rohstahlproduktion im Jahr 2020. <https://de.statista.com/statistik/daten/studie/311503/umfrage/wichtigste-laender-nach-rohstahlproduktion/>. Accessed 27 Apr 2022
  13. Sturm, J.C.: Energie- und Rohstoffeinsparung durch konsequente Nutzung der Gießprozesssimulation. *Giesserei* **98**(06), 82–98 (2011)

**Open Access** This chapter is licensed under the terms of the Creative Commons Attribution 4.0 International License (<http://creativecommons.org/licenses/by/4.0/>), which permits use, sharing, adaptation, distribution and reproduction in any medium or format, as long as you give appropriate credit to the original author(s) and the source, provide a link to the Creative Commons license and indicate if changes were made.

The images or other third party material in this chapter are included in the chapter's Creative Commons license, unless indicated otherwise in a credit line to the material. If material is not included in the chapter's Creative Commons license and your intended use is not permitted by statutory regulation or exceeds the permitted use, you will need to obtain permission directly from the copyright holder.





# Evaluation of Material Properties of Spruce Wood Samples to Improve the Development Process for More Sustainable Sawing Processes

J. Schmidt<sup>1</sup>(✉), F. Schreiner<sup>1</sup>, B. Thorenz<sup>1,2</sup>, and F. Döpfer<sup>1,2</sup>

<sup>1</sup> University of Bayreuth, Chair Manufacturing and Remanufacturing Technology,  
Universitätsstraße 30, 95447 Bayreuth, Germany  
Julian.Schmidt@uni-bayreuth.de

<sup>2</sup> Fraunhofer IPA Project Group Process Innovation, Universitätsstraße 9, 95447 Bayreuth,  
Germany

**Abstract.** The processing of wood as a renewable and sustainable material is steadily gaining in importance. However, sawing processes in sawmills are characterized by high electrical energy consumption. Improving the geometry of the saw teeth is an option to make sawing processes more energy efficient and sustainable. Since the industrial sawing processes in sawmills are rather inflexible, the development of new saw tooth geometries takes place in smaller experimental setups. However, the inhomogeneous and anisotropic properties of wood make it difficult to compare different material samples and saw teeth on the basis of measured values. This leads to untapped potentials regarding energy efficiency and sustainability in industrial sawing processes. This paper discusses material properties of spruce wood samples, depending on their place of extraction from the tree trunk. The measured variables considered are the wood moisture content, strength properties and the cutting force occurring during the sawing process. The results show that the measured values vary to different degrees within a tree trunk and between different tree trunks. Based on the results the validity of comparison measurements in the tool development process can be improved and thus increase the efficiency and sustainability of industrial sawing processes.

**Keywords:** sawing · material properties · wood

## 1 Introduction

Wood is becoming increasingly attractive as the most important renewable raw material. Particularly as a raw material, construction material and energy source. Wood can act as an effective carbon store, since it consists of half carbon. This is especially true when it is used in durable products, where carbon remains sequestered harmlessly to the climate. Furthermore, finite and climate-damaging fossil raw materials can be replaced by wood. Less carbon is released than when fossil fuels are used, resulting in a positive CO<sub>2</sub> balance [1].

The demand for more environmentally friendly solutions also poses new challenges for wood technology. Rising energy costs and scarce resources must lead to further development of woodworking processes. This also applies in particular to the machining of wood-based materials. Although wood is one of the oldest materials used by mankind, it still presents people with major challenges [2]. Especially when machining wood, a lot of experience and also knowledge about the material behavior is essential. And although individual sub-areas are known, an exact prediction regarding all influencing variables during the machining process is not possible [3]. Problems arise mainly from the fact that wood is a natural material with hygroscopic and anisotropic properties [4]. In addition, there is a high degree of scatter in terms of material behavior and measurable values both within a wood species and within a single trunk. [5]. Each tree has its own history due to its location and the climatic conditions prevailing there, which has an influence on the structure of the tree [6]. New developments and improvements can therefore only be realized through deeper knowledge of wood as a material and the fundamentals of processing methods [2].

One way to improve the process is to optimize the cutting tool. In this way, target parameters of the cutting process such as cutting force, wear and energy consumption can be positively influenced. In order to obtain meaningful testing results for newly developed tools, the scatter of material properties on the samples must be kept as low as possible. The results of this paper help to better assess the influence of the location of wood sampling from the trunk. Thus, the results from comparative tests can be interpreted more accurately in the context of saw tooth development.

## 2 State of the Art

Wood is a complex and flexible material. It consists of numerous substances that are organized in different ways, resulting in an irregular structure. This allows its use for various product areas [6]. Wood is a non-uniform, inhomogeneous material consisting of different types of cells [4]. This material can be regarded as a complex, porous fiber composite material. It consists of long rectified natural polymeric tubes embedded in a natural polymer matrix [7]. The main components of wood are cellulose fibres (43%–46%), hemicellulose (27%–37 %), lignin (20%–27 %) and accompanying components such as organic extractives and inorganic minerals (0,5%–10 %) [8].

The structural composition of wood can be divided into the three structural levels fiber structure, cell structure and macrostructure. The fiber structure is predominantly crystalline and is interrupted by amorphous areas. The cellulose bundles are enclosed by hemicellulose and lignin. The entire bundle is called a microfibril [9].

The cell structure is the next higher structural level. The elongated cells usually have mostly a length-diameter ratio of more than 100 [4]. All wood cells are structured according to the same scheme. The cell walls consist of four wall layers (middle lamella, primary wall, secondary wall, and tertiary wall) formed from microfibrils. The individual layers are concentric around the cavity of the cells, the lumen [7]. In coniferous wood, a distinction is made exclusively between two cell types (tracheids and parenchyma cells). The cells are capable of performing different functions. The quantitatively superior tracheids serve for water conduction and mechanical stability. They die shortly after

their formation. The significantly shorter parenchyma cells are found in the wood rays and resin canals, among other places [8].

The macrostructure is determined by a radial structure of several layers. Running from the outside of the tree inward are outer bark, inner bark, cambium, sapwood, heartwood, and pith [4]. The outer bark, or bark, serves as the outer protective layer of the tree. Directly below it is the inner bark, which is called the bast. The next layer is called the cambium. The cambium is responsible for the thickness growth of the tree [10]. In regions where division activity is dormant due to climatic conditions, wood forms in annual growth periods [11]. The cells formed in spring have a larger diameter than those formed in late summer and autumn. The wood formed at the end of the growing season has higher density and thicker cell walls due to the smaller cell diameter. The succession of early and late wood produces the clearly visible annual rings [4, 10]. This is followed by the sapwood, which contains living cells. The cells in the sapwood transport water and store nutrients. The heartwood forms the inner zone of the tree and serves exclusively for the mechanical stability of the trunk. In the middle is the pith [7].

### 3 Approach and Experimental Detail

#### 3.1 Sample Collection

For the investigations carried out in this paper, wood samples were taken from a total of five spruce tree trunks. Spruces represent the most common tree species in Germany [12] and are also mainly processed in the sawmill where the preparation of the tree trunks was carried out.

The tree trunks have a length of 12 m and are between 200 and 250 years old. Their diameter at breast height is at least 49 cm each. Samples are taken from the lower, middle and higher section of each tree trunk. The following Fig. 1 shows the dimensions and sampling graphically.

Radial samples are taken from each test package. For the shear tests, the bending tests and the kiln-drying tests, two samples per cardinal direction are taken. The samples for all types of tests and with the same sample number should have the same distance to the pith. For the cutting tests, only one sample per cardinal direction is cut out due to the necessary sample size.

#### 3.2 Measurement of Cutting Force

The cutting force  $F_c$  has a direct influence on the energy consumption of the sawing process [13] and is therefore considered in this paper. The saw operations were performed on a DMU 50 eVolution five axis machining center using an insertable two teeth circular sawblade developed for experimental setups. A total of 60 wood samples with the dimensions 80 mm × 90 mm × 180 mm were examined at a tool rotational speed  $n = 330$  rpm and a feed speed of  $v_f = 1066.88$  mm/min. The sawing operation was carried out along the fibre direction, which corresponds to the cutting direction B according to KIVIMAA [14] as well as the direction in which the wood is processed in a sawmill. Three cuts were made in each wood sample with a cutting depth  $a_e$  of 40 mm. The cutting force  $F_c$  is measured with a sensoric tool holder with a sampling rate of 1,600 Hz.

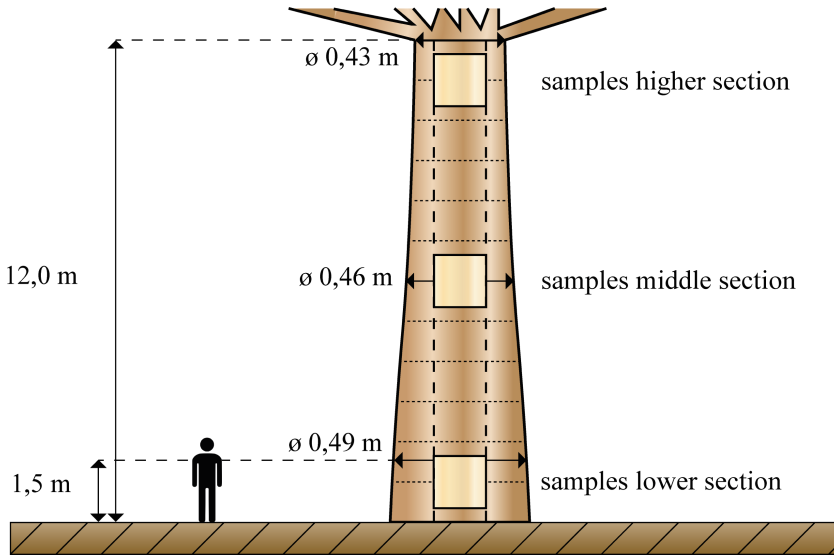


Fig. 1. Original tree trunk dimensions and location of the extracted wood sample packages

### 3.3 Measurement of Wood Moisture

The wood moisture content has a significant influence on the cutting force  $F_c$ , as it exerts a major influence on the general strength of the wood [14]. The moisture content  $\omega$  of the wood samples is determined using the kiln-drying method according to DIN EN 13183-1 [15]. A total of 120 kiln-dried samples with dimensions of 20 mm  $\times$  20 mm  $\times$  20 mm were examined. After the first weighing, the kiln samples were dried in a Memmert UF-55 drying oven at 103 ( $\pm 2$ ) °C until the weight difference between two measurements ( $m_1 - m_0$ ) was less than 0.1%. The wood moisture content  $\omega$  can be determined by the following Eq. 1:

$$\omega = \frac{m_1 - m_0}{m_0} \cdot 100 \quad (1)$$

### 3.4 Measurement of Strength Properties

Due to the inhomogeneity and anisotropy of wood, one characteristic value is not sufficient to describe its strength property [2], which is why both bending and shear strength were investigated. Both the bending strength  $f_v$  and the shear strength  $\tau_{||}$  are measured according to the corresponding standards DIN 52186 and DIN 52187 [16, 17]. Both tests are performed on a Zwick Z0150 universal machine, which was extended by a shear fixture for the shear tests. The following Table 1 lists the test conditions under which the measurements were carried out.

**Table 1.** Experimental setup for the measurement of strength properties

Test condition	Three-point bending test	Shear test
Measured property	bending strength $f_v$	shear strength $\tau_{  }$
Standard	DIN52186	DIN52187
Number of samples	120	120
Sample dimension $l \times w \times h$ [mm]	$360 \times 20 \times 20$	$50 \times 50 \times 50$
Feed force $F_{max}$ [N]	10	20
Force direction	transverse to fibre	parallel to fibre
Testing speed $v$ [mm/min]	20	10

The bending strength  $f_v$  and the shear strength  $\tau_{||}$  are determined according to the following Eqs. 2 and 3 with the parameters max. Force  $F_{max}$ , sample length  $l$ , sample width  $w$ , sample height  $h$  and shear area  $A$ :

$$f_v = \frac{3 \cdot F_{max} \cdot l}{2 \cdot w \cdot h^2} \quad (2)$$

$$\tau_{||} = \frac{F_{max}}{A} \quad (3)$$

## 4 Results and Discussion

The mean moisture content  $\omega$  of all wood samples is 17.6%, whereby the variation coefficient  $V$  is very low at 0,07 for all kiln-dried samples. However, no dependence of the wood moisture  $\omega$  on the sample location can be proven. The measured values are lower than expected. This difference can be attributed to several factors. On the one hand, the samples could not be weighed immediately enough after cutting. Secondly, the trees were felled in late autumn, when they have a lower moisture content than in spring or summer [18].

The following Fig. 2 shows that the bending strength  $f_v$  has a clear trend depending on the location of sample collection.

While the averaged values for samples on the lower section of the trunk are the highest at 45.57 N/mm<sup>2</sup>, they are lowest for samples from the upper section of the trunk at 36.92 N/mm<sup>2</sup>. This can be explained by the fact that density in tree trunks decreases with increasing trunk height [19]. The scatter of the data behaves in the opposite way, which is shown by the coefficient of variation  $V$  of 0.197 for low-, 0.233 for middle-, and 0.269 for high-section samples.

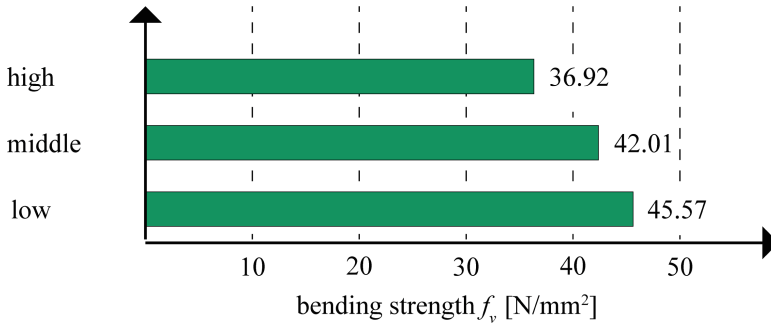


Fig. 2. Bending strength  $f_v$  depending on the location of sample collection

For the shear strength  $\tau_{||}$ , increased values could be measured for samples taken from the middle section of the trunk, compare Fig. 3 below.

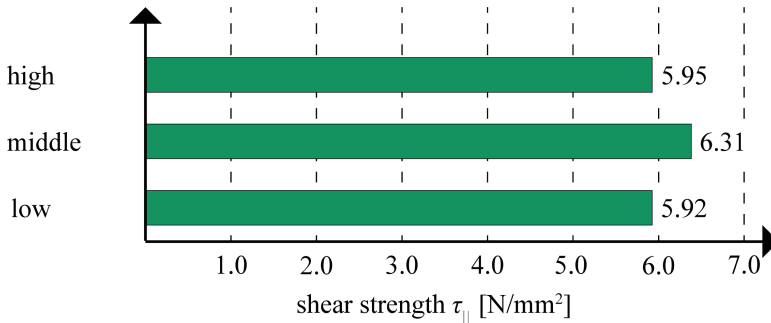
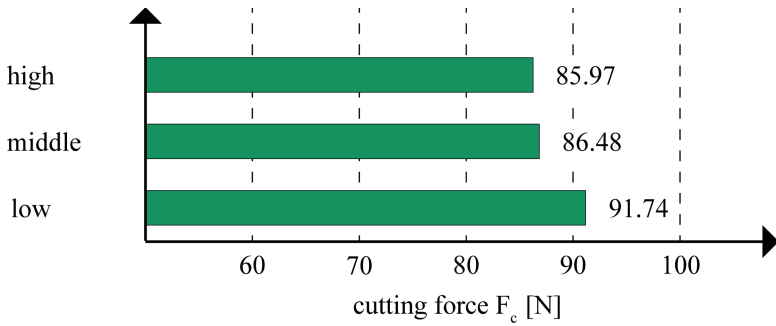


Fig. 3. Shear strength  $\tau_{||}$  depending on the location of sample collection

At 6.31 N/mm<sup>2</sup>, the mean shear strength  $\tau_{||}$  was 6.0% higher than for samples from the upper section and 6.4% higher than for samples from the lower section of the trunk. The scatter of the values is smaller than for the bending strength  $f_v$ , which is shown by the coefficient of variation  $V$  of 0.149 for low-, 0.128 for middle-, and 0.149 for high-section samples.

The following Fig. 4 shows that the cutting force  $F_c$  has a slight trend depending on the location of sample collection.

While the averaged values for samples on the lower section of the trunk are the highest at 91.74N, they are lowest for samples from the upper section of the trunk at 85.97 N. The scatter of the data behaves in the opposite way, which is shown by the coefficient of variation  $V$  of 0.384 for low-, 0.370 for middle-, and 0.380 for high-section samples. Thus, both for the measured values and their scatter, a direct correlation between the bending strength  $f_v$  and the required cutting force  $F_c$  can be concluded.



**Fig. 4.** Cutting Force  $F_c$  depending on the location of sample collection

Finally, the following Table 2 compares the scatter of the measured values within a trunk and based on the sample location using the averaged coefficients of variation. It is shown that the scatter of the measured values is at a similar level, but slightly lower within a trunk for all properties. The scattering of measured values between individual strains can be attributed to different growth locations and the resulting variation in growth conditions, such as light conditions.

**Table 2.** Average variation coefficients  $V$  within a trunk and within a sample location

Property	Variation coefficient $V$ within a trunk	Variation coefficient $V$ depending on sample location
Moisture content	0.068	0.072
Bending strength	0.210	0.233
Shear strength	0.136	0.142
Cutting force	0.372	0.378

## 5 Conclusion and Outlook

It has been shown that the location of spruce wood sampling within a trunk has significant effects on the mechanical properties measured. While moisture content  $\omega$  varied only slightly in the samples tested, increased shear strength  $\tau_{||}$  was shown for wood samples taken from the middle section of a trunk. Furthermore, it was shown that the bending strength  $f_v$  decreases with increasing log height and that this effect is also reflected in the required cutting force  $F_c$  in the sawing tests.

In order to interpret test results correctly in the context of developing more efficient and more sustainable sawing processes, these results must be taken into account in any case. However, it could also be shown that the variation of measured values between individual trunks is on a similar level as the variation based on different locations where samples have been extracted from the trunk. If possible, both factors should be considered



and samples should be taken from a specific area of a single trunk. If this is not possible, samples from a single tree promise slightly more stable measurement results than from the same trunk area of several trunks.

Starting points for further research are, for example, the investigation of further tree species or the consideration of further mechanical properties.

## References

1. Bundesministerium für Ernährung und Landwirtschaft: Unser Wald – Natur aus Försterhand. Druck- und Verlagshaus Zarbock GmbH & Co. KG, Frankfurt am Main (2018)
2. Gottlöber, C.: Zerspanung Holz und Holzwerkstoffen – Grundlagen – Systematik – Modellierung – Prozessgestaltung. Hanser Verlag, München (2014)
3. Rehm, K.: Untersuchung zur Modellierung des Qualitätsbildungsmechanismus beim Fräsen unter Berücksichtigung der Mehrachsbearbeitung. TU Dresden, Dresden (2002)
4. Kollmann, F.: Technologie des Holzes und der Holzwerkstoffe, vol. 1, 2nd edn. Springer Verlag, Berlin (1951)
5. Steiger, R.: Mechanische Eigenschaften von Schweizer Fichten-Bauholz bei Biege-, Zug-, Druck- und kombinierter M/N Beanspruchung: Sortierung von Rund- und Schnittholz mittels Ultraschall. ETH Zürich, Zürich (1996)
6. Zobel Bruce, J., van Buijtenen, J.P.: Wood Variation: Its causes and control. Springer Verlag, Berlin (1989)
7. Askeland, D.R.: Materialwissenschaften. Spektrum Akademischer Verlag, Heidelberg (1996)
8. Wagenführ, A., Scholz, F.: Taschenbuch der Holztechnik, 2nd edn. Hanser Verlag, Leipzig (2012)
9. Nutsch, W., Eckhard, M.: Fachkunde Holztechnik. Verlag Europa Lehrmittel, Haan-Gruiten (2007)
10. Trendelenburg, R.: Das Holz als Rohstoff. J.F. Lehmann, München, Berlin (1939)
11. Ross, R.J.: Wood Handbook – Wood as an Engineering Material. Forest Products Laboratory, Madison WI, USA (2010)
12. Bundesministerium für Ernährung und Landwirtschaft. Der Wald in Deutschland – Ausgewählte Ergebnisse der dritten Bundeswaldinventur. 3rd edn., Berlin (2018)
13. Degner, W., et al.: Spanende Formung: Theorie – Berechnung – Richtwerte, 17th edn. Hanser Verlag, München (2015)
14. Kivimaa, E.: Cutting Force in Wood-Working. TH Helsinki, Helsinki (1950)
15. Din Deutsches Institut Für Normung E.V.: 2002. EN, D. 13183–1. „Feuchtegehalt eines Stückes Schnittholz. Teil I: Bestimmung durch Darrverfahren“. Deutsche Fassung EN ISO 13183-I:2002. Beuth Verlag GmbH, Berlin (2002)
16. Din Deutsches Institut Für Normung E.V., 1978 EN, D. 52186. Prüfung von Holz; Biegeversuch“. Beuth Verlag GmbH, Berlin (1978)
17. Din Deutsches Institut Für Normung E.V., 1979 EN, D. 52187. Prüfung von Holz; Bestimmung der Scherfestigkeit in Faserrichtung. Beuth Verlag GmbH, Berlin (1979)
18. Niemz, P., Sonderegger, W.: Holzphysik – Physik des Holzes und der Holzwerkstoffe. Hanser Verlag, Leipzig (2017)
19. Kollmann, F.: Schwankungen von Wachstum, Zuwachs und spezifischer Masse (Rohdichte und Raumdichte) bei Hölzern. Holz als Roh- und Werkstoff **36**, 111–119 (1978)

**Open Access** This chapter is licensed under the terms of the Creative Commons Attribution 4.0 International License (<http://creativecommons.org/licenses/by/4.0/>), which permits use, sharing, adaptation, distribution and reproduction in any medium or format, as long as you give appropriate credit to the original author(s) and the source, provide a link to the Creative Commons license and indicate if changes were made.

The images or other third party material in this chapter are included in the chapter's Creative Commons license, unless indicated otherwise in a credit line to the material. If material is not included in the chapter's Creative Commons license and your intended use is not permitted by statutory regulation or exceeds the permitted use, you will need to obtain permission directly from the copyright holder.





# Liquid Desiccant Dehumidification Systems: Jet Cross-Talking Effect in Multi-electrosprays

Winnie Mutenhabundo<sup>1</sup>, Tawanda Mushiri<sup>1,4(✉)</sup>, Timothy Gutu<sup>2</sup>,  
and Patson Zvandasara<sup>3</sup>

<sup>1</sup> Department of Industrial and Mechatronics Engineering, University of Zimbabwe,  
Mt Pleasant,

P.O Box MP167, 263 Harare, Zimbabwe  
tawanda.mushiri@gmail.com

<sup>2</sup> Department of Physics, University of Zimbabwe, Mt Pleasant, P.O Box MP167, 263 Harare,  
Zimbabwe

<sup>3</sup> Department of Obstetrics and Gynecology, University of Zimbabwe, Mt Pleasant, P.O Box  
MP167, 263 Harare, Zimbabwe

<sup>4</sup> Biomedical Engineering and Healthcare Technology (BEAHT) Research Centre,  
Faculty of Health Sciences, University of Johannesburg, Johannesburg, South Africa

**Abstract.** When liquid desiccant systems are employed to dehumidify air electro-spraying technique helps to increase the surface area of the liquid. Multiplexing of the jets by introducing several emitters for increased efficiency is commendable but, there is a tendency of the jets to cross talk with each other due to electrical shielding. Cross talking of jets will result in the failure of the jets to break properly into droplets for effective dehumidification. This piece of work analyzed the conditions for electrical shielding among jets which results in efficient electrospray. To evaluate how cross talking affects multiple emitter nozzles, the mathematical model was built by superimposing the electric potentials of one emitter in an array of emitters. A Computational Fluid Dynamics simulation model was developed to investigate the conditions for electrical shielding among jets during electrospray process with glycerol as the working substance. In flow modelling, Ansys Fluent with Volume of Fluid and the Taylor Dielectric model were involved. The flow rate that guarantees stability in the electrospray was determined together with the optimum voltage resulting in a spray current which reduces electrical shielding. An analysis on the electrical conductivity of the liquid to ensure stability and efficiency in electrospray was done. The pressure contours of the nozzle were determined together with velocity of the desiccant against density. Emitter spacing, applied voltage, flow rate and the electrical conductivity plays a pivotal role on the prevention of cross talking of jets during the electro-spraying process.

**Keywords:** Electrospray · Multiple Emitters · Electrical Shielding · CFD Model

## 1 Introduction

If air is to be conditioned, control is given to sensible load as well as latent load. The use of vapour compression based refrigeration systems to condition air has been condemned

of their significant reliance on electricity [1]. This is so because the sensible and latent heat load are controlled by cooling air below dew point which at times may require reheating to achieve required temperature which is an energy intensive effort, [2, 3] Evaporative cooling is an energy efficient technology which can be used in place of conventional vapour compression systems [4–6].

Nevertheless, in humid climates the use of evaporative cooling based air conditioning systems is ineffective due to high levels of humidity in the unprocessed air. The use of desiccant dehumidification in handling the latent load in such air is commendable, [7–10]. Both solid and liquid desiccants can be employed, however, the use of liquid desiccants is advantageous over that of solid desiccants, [11]. When using liquid desiccant to dehumidify, water removal rate is mainly determined by the size of the contact surface [3]. In order to ensure an increased surface contact between the desiccant and the air to be processed, droplet diameter reduction is fundamental. Reducing the diameter of the droplet drastically increases the efficiency of the dehumidification process [12].

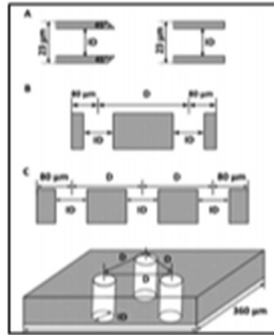
Among other droplet reducing mechanism, research shows that the electrospray process is a capable, energy efficient process which produces a fine spray, [3, 12–16]. The meniscus is exposed to a heavy electric field so that the liquid desiccant is converted into a cone-jet by the electrostatic force, [17]. When there is a balance between the external electric forces and the surface tension forces, the electrically charged droplet becomes unstable resulting in the emission of a liquid jet, [18]. The process allows blending of electrical, rheological and geometric properties of the liquid jet as it flows from the electrically-charged orifice, [14]. This process is studied in a discipline called electro-hydrodynamics, (EHD [19]).

The electrospraying method has found use in various areas for the creation of monodisperse sprays of very fine drops in industry [20, 21]. It is possible to use a single emitter or to have a number of emitters during the process, [17]. In the event that a jet is produced by a single emitter, the solo emitter offers advantages of elimination of cross talking of jets, nonetheless, the solo emitter have low flow rates thus its use compromises the electrospray process and the resultant dehumidification, [3, 12, 21].

If multiplexing is allowed by running several emitters simultaneously at high operating voltages, there will be an increase in dehumidification process efficiency because of the increased surface area, [12, 17]. Nevertheless, space charge becomes significant attributable to the cloud of charged droplets in the multiplexed emitters, [21]. Electrical shielding will then occur causing cross talking of jets which is basically the obstruction of the electric field neighboring the surface of some conical menisci hindering proper formation of the required Taylor cone, [22]. This electrical shielding results in reduced stability and effectiveness of the overall electrospray process, [23]. Cross talking of jets will result in the failure of the jets to break properly into droplets for effective dehumidification. The interaction problem between the jets in multiplexed spray presents a need to analyze this shielding effect in liquid desiccant dehumidification process, [14, 18].

## 2 Theory

The configuration of emitters in a multi-electrospray set up can be as presented in Fig. 1 where there is a representation of a mono-hole system whose tip can be levelled or pointed, a double and a triple-hole emitter, [12].



**Fig. 1.** Emitter configuration in multi-electrospray[12]

Several researches have been done to analyse the interaction problem in multiplexed jets during electro-spray, [13, 21]. It has been found that the factors that affect jet behavior include the operating voltage, flow rate and emitter spacing in an array of emitter [12]. If one emitter is in operation and the distance between the emitters is reduced, more potential is needed to produce cone jet which is stable because of shielding effect [13]. The required potential decreases at a very close spacing. When an electrical potential exists, the forming of a cone-jet which can decompose into equally-sized droplets is fundamental [12]. Several configurations like coaxial and parallel flows can be produced from the electro-spray.

Flow rate is an important aspect to guarantee stability and efficiency of the electro-spray. When the flow rate is approximately 6 mL/min or more, 2D, rotating 2D, and 3D spray forms will be observed. At low flow rates of ~ 6 mL/min or lower, there is no change in the discharge current with respect to flow rate across the liquids [21]. Flow rate in stable electro-spray systems is always small. The applied voltage does influence the magnitude of the flow rate through the jet of the electro-spray due to the variation in cone surface area with applied voltage [18].

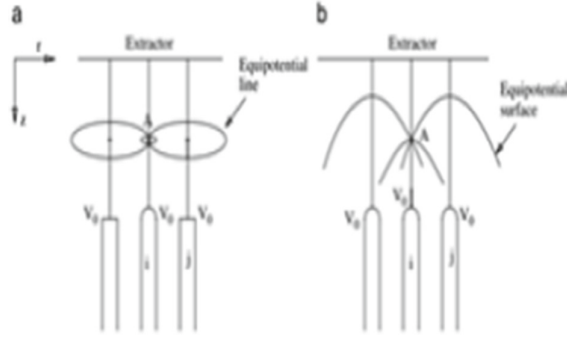
Electrical forces mainly controls the velocity of droplets in wide range of dispersed liquid conductivity [14]. The diameter of the liquid is also determined by the electrical conductivity, the higher the liquid electrical conductivity the smaller the diameter [22]. More so, applied voltages strongly affects the diameter of droplet, and droplet diameter decreases with an increase in applied voltage which is of very high electric fields of several kilovolts, up to 30 kV. In a multiplex set up, spacing of emitters has a pivotal part in jet formation as there tends to be interference.

### 3 Mathematical Model

Figure 2 shows progression of equipotential lines where there is single and multiple jetting.

Therefore, the potential at point A of the *i*th emitter,  $V_i$ , can be obtained as follows by using Eq. (1) and superposing the electric potential values from every emitter:

$$V_i(z) = \sum_{j=1}^N A_j V_{ij}(z, d_{ij}), \quad i = 1 \dots N \tag{1}$$



**Fig. 2.** a) Central emitter jetting and (b) Three emitters jetting [21].

where  $A_j$  is a fraction of the electric potential contributed by  $j$ th emitter,  
 $V_{ij}$  is the potential at A of the  $i$ th emitter.

The maximum electric field can be represented as:

$$E_0(z_0 + z_a) = -V_0 \sum_{J=1}^N B_J \frac{dV_{ij}}{dz} (z_0 + z_a, d_{ij}) \quad (2)$$

where

$$\frac{dV_{ij}}{dz} (z_0 + z_a, d_{ij}) = \frac{-\sigma}{4\pi d \epsilon_0} \left[ \frac{1}{\{d_{ij}^2 + (2z_0 + z_a)^2\}^{\frac{1}{2}}} + \frac{1}{\{d_{ij}^2 + z_a^2\}^{\frac{1}{2}}} \right] \quad (3)$$

Then the final equation for the operating voltage becomes

$$V_{i0} = - \frac{E_0(z_0)}{\sum_{j=1}^N B_J \left( \frac{dV_{ij}}{dz} \right) (z_0, d_{ij})} \quad (4)$$

From these equations we can obtain the quantitative result for onset voltage using the required local electric field strength,  $E_0$ , but this solution is only valid when  $d_{ij}$  is larger than  $2r_c$  to avoid overlapping of capillaries.

## 4 Simulation Model

The CFD simulations in this piece of work were done with the commercially available software package, ANSYS Fluent v16. The liquid spray is taken as laminar flow with the solid capillary subjected to huge electric potential. Glycerol (C3H8O3) was used as the jetting liquid, with density =  $1.261 \text{ gcm}^{-3}$ , viscosity =  $1.412 \text{ cP}$  (at  $25^\circ\text{C}$ ), surface tension =  $63.4 \text{ mN/m}$ , electrical conductivity =  $0.05 \text{ } \mu\text{S/cm}$ , [3].

An axis-symmetric multi-hole nozzle geometry was created using Design modeler of Ansys Fluent. Designer modeler is a built in geometry and grid creation system with CAD functions to create and manipulate whole geometries with a subsequent meshing.

For better accuracy and better visualization of flow behavior of the desiccant falling film during numerical modeling, grid points after meshing were fine near the nozzles since there will be larger electric potential gradients and be coarse for areas afar. This will ensure accuracy with minimal computational effort since coarseness decreases accuracy whilst fineness increases time. A Cartesian mesh was applied to achieve this.

After setting up the geometry, the solver settings were chosen in Ansys Fluent the EHD was combined with other modules to allow simultaneous simulation of different physical domains at the same time. A pressure based solver based on transient time and an absolute velocity formulation was used. The Eulerian approach of the two phases of volume of fluid were used in the multiphase model. The Eulerian method was adopted instead of the Lagrangian because it works well for flow in a continuous phase. The primary phase was set to air, while the secondary phases were set to glycerol. The material properties of all phases were set to values that have been established in literature. An implicit velocity fraction parameters with an enhanced near wall treatment was adopted. The standard and non-equilibrium wall functions of near wall treatment work with a coarse mesh and they don't provide details about velocity whilst the enhanced wall treatment needs a fine mesh giving a velocity profile which is more accurate and well predicted even in the viscous and buffer layers.

Boundary conditions were then defined so as to solve equations discussed in previous sections. The inlet was considered as having a constant velocity back flow fraction of glycerine whilst outlets had glycerine jets produced. A velocity specification method was used which is normal to the boundary and after passing the zero-voltage plane at constant velocity. To ensure a no-slip shear condition, a stationary wall was assumed [15].

For the flow solution, the equations were then solved numerically giving a full representation of the flow using a PISO solver. A transient formulation was employed with hybridization to improve accuracy was used together with compressive volume fraction for fluid flow and free surface, [12, 14, 18]. Standard initialization was used with a variable time step method and a reference frame relative to the cell zone.

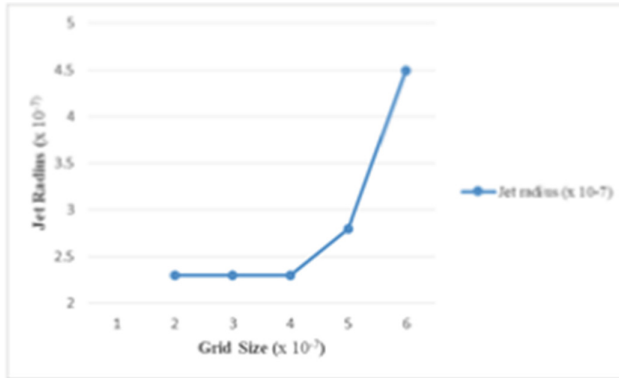
## 5 Results and Discussions

### 5.1 Mesh Sensitivity Test

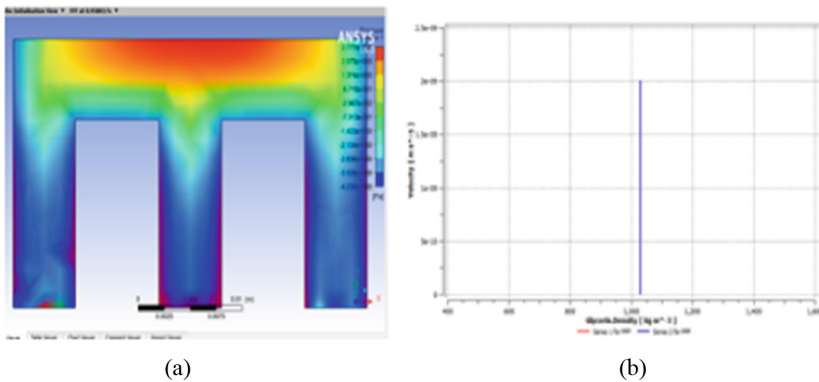
Outcome of convergence study is as in Fig. 3 having jet radius as a function of minimum cell size, [15]. The size of the mesh was of  $2 \times 10^{-7}$  m. It can be deduced from Fig. 3 that the jet radius is independent of grid size when its size is less than  $0.24 \mu\text{m}$  in the center line and it is related to the 761462 total mesh numbers.

### 5.2 Electrostatic Atomization

The presence of an electric body force allowed the liquid to produce a conical shape termed as Taylor cone and a thin jet was produced from its apex. Formation of a stable Taylor cone is possible with flow rate in the range of 3–10 ml/hr. And a constant electrical conductivity of  $0.04 \text{ K(S/cm)}$ . For a single emitter, the tapered emitter design resulted in



**Fig. 3.** Mesh Convergence study



**Fig. 4.** a.) Pressure contours on the nozzle b.) Velocity of the desiccant against density.

an effective Taylor cone which promotes stable electrospray process whilst maintaining constant fluid velocity charge density jet radius and electric field, Fig. 4

From the simulations, it can be seen that the kinetic energy was increasing as the Taylor cone was generated. Increasing flow rate at a constant voltage resulted in an increase in Taylor cone size. An attempt to further increase voltage results in a decrease in droplet size, however, very high voltage could not enable jet formation as the jets became too thin, breaking up leading to the loss of stability and this is in agreement with the literature. From the simulation results, it showed that a thicker jet will be produced due to the larger cone.

Apart from the operating voltage and liquid flow rates, jet formation was seen to be affected by the distance between the nozzles. Repulsive forces were experienced when emitters are close to each other (that is  $60 \mu\text{m}$  apart), this will result in the jets exerting a force that will separate the jets. The results from these simulations agree with the experimental results reported in literature [3].



Designing a wide range of emitters which are spaced help in preventing cross talking whilst maintaining electrospray efficiency. The dehumidification section must be working continuously without changing the frequency to ensure improved efficiency with it knowing when to start and stop.

## 6 Conclusions

Ansys fluent has aided to successfully model the electrical shielding effect among jets using 3 emitters to allow multiplexing. The emitter spacing, voltage, flowrate and liquid conductivity plays a pivotal role on the prevention of cross talking of jets during the electrospraying process. The model is essential in atomization of liquid desiccant for moisture removal in air for air conditioning purposes using evaporative cooling technology. Future work needs to look at the possibility of spray blockages at the menisci due to electrical shielding in multiplexed jets in electrospray and allow the dehumidification section must be working continuously without changing the frequency to ensure improved efficiency with it knowing when to start and stop.

## References

1. Mariotti, M., Moro, L.: Indirect evaporative cooling combined with dehumidification in a MVHR system for radiant cooling. *Energy Procedia* **101**(September), 448–455 (2016)
2. Rafique, M.M., Gandhidasan, P., Bahaidarah, H.M.S.: Liquid desiccant materials and dehumidifiers – A review. *Renew. Sustain. Energy Rev.* **56**, 179–195 (2016)
3. Salazar, M.G., Jiménez, R.Z., Loscertales, I.G., Reyes, A.H.: Electrospray technique to produce fine sprays of desiccant liquids. Application to moisture removal from air. *Energy Build.* **162**, 187–197 (2018)
4. Cao, G., Storås, M.C.A., Aganovic, A., Stenstad, L.I., Skogås, J.G.: Do surgeons and surgical facilities disturb the clean air distribution close to a surgical patient in an orthopedic operating room with laminar airflow? *Am. J. Infect. Control* **46**(10), 1115–1122 (2018)
5. Tao, W., Yimo, L., Lin, L.: A novel 3D simulation model for investigating liquid desiccant dehumidification performance based on CFD technology. *Appl. Energy* **240**, 486–498 (2019)
6. Pomianowski, M., Andersen, C.H., Heiselberg, P.: Technical potential of evaporative cooling in Danish and European condition. *Energy Procedia* **78**, 2421–2426 (2015)
7. Arandara, K.P., Attalage, R.A., Jayasinghe, M.T.R.: Thermal comfort with evaporative cooling. *Int. Conf. Sustain. Built Environ. Kandy* (2014)
8. Dai, Y.J., Wang, R.Z., Zhang, H.F., Yu, J.D.: Use of liquid desiccant cooling to improve the performance of vapor compression air conditioning. *Appl. Therm. Eng.* **21**(12), 1185–1202 (2001)
9. Jain, S., Dhar, P.L., Kaushik, S.C.: Evaluation of liquid desiccant based evaporative cooling cycles for typical hot and humid climates. *Heat Recovery Syst. CHP* **14**(6), 621–632 (1994)
10. Fakhraadi, F., Kowsary, F.: Optimal design of a hybrid liquid desiccant-regenerative evaporative air conditioner. *Energy Build.* **133**, 141–154 (2016)
11. Rafique, M.M., Gandhidasan, P., Rehman, S., Al-Hadhrani, L.M.: A review on desiccant based evaporative cooling systems. *Renew. Sustain. Energy Rev.* **45**, 145–159 (2015)
12. Wu, X., Oleschuk, R.D., Cann, N.M.: Characterization of microstructured fibre emitters : in pursuit of improved nano electrospray ionization performance. *Analyst* **137**(18), 4150–4161 (2012)

13. Jaworek, A., Sobczyk, A., Krupa, A., Lackowski, M., Czech, T.: Electrostatic deposition of nanothin films on metal substrate. *Bull. Polish Acad. Sci.: Tech. Sci.* **57**(1), 63–70 (2009)
14. Najjaran, A., Ebrahimi, R., Rahmanpoor, M., Najjaran, A.: Numerical simulation of electrohydrodynamic(EHD) atomization in the cone-jet mode. *Appl. Mech. Mater.* **327**(June), 180–185 (2013)
15. Rahmanpour, M., Ebrahimi, R., Pourrajabian, A.: Numerical simulation of two-phase electrohydrodynamic of stable Taylor cone–jet using a volume-of-fluid approach. *J. Braz. Soc. Mech. Sci. Eng.* **39**(11), 4443–4453 (2017). <https://doi.org/10.1007/s40430-017-0832-7>
16. Borra, J.: Review on water electro-sprays and applications of charged drops with focus on the corona-assisted cone-jet mode for High Efficiency Air Filtration by wet electro-scrubbing of aerosols To cite this version : HAL Id : hal-02415646 (2019)
17. Parhizkar, M., et al.: Performance of novel high throughput multi electro spray systems for forming of polymeric micro/nanoparticles. *Mater. Des.* **126**(April), 73–84 (2017)
18. Rahmanpour, M., Ebrahimi, R.: numerical simulation of electrohydrodynamic spray with stable Taylor cone-jet. *Heat Mass Transf.* **52**(8), 1595–1603 (2015)
19. Pozniak, B.P., Cole, R.B.: Perspective on electro spray ionization and its relation to electrochemistry. *J. Am. Soc. Mass Spectr.* **26**(3), 369–385 (2015)
20. Thompson, J.W., Eschelbach, J.W., Wilburn, R.T., Jorgenson, J. W.: Investigation of Electro spray Ionization Using a Three-Dimensional Electro spray (2005)
21. Quang, B., Si, T., Byun, D., Lee, S.: “Experimental and theoretical study of a cone-jet for an electro spray microthruster considering the interference effect in an array of nozzles. *J. Aerosol Sci.* **38**(9), 924–934 (2007)
22. Bocanegra, R., Galán, D., Márquez, M., Loscertales, I.G., Barrero, A.: Multiple electro sprays emitted from an array of holes. *J. Aerosol Sci.* **36**(12), 1387–1399 (2005)
23. Wang, J., Jansen, J.A., Yang, F.: Electro spraying : possibilities and challenges of engineering carriers for biomedical applications — a mini review. *Front. Chem.* **7**, 1–9 (2019)

**Open Access** This chapter is licensed under the terms of the Creative Commons Attribution 4.0 International License (<http://creativecommons.org/licenses/by/4.0/>), which permits use, sharing, adaptation, distribution and reproduction in any medium or format, as long as you give appropriate credit to the original author(s) and the source, provide a link to the Creative Commons license and indicate if changes were made.

The images or other third party material in this chapter are included in the chapter’s Creative Commons license, unless indicated otherwise in a credit line to the material. If material is not included in the chapter’s Creative Commons license and your intended use is not permitted by statutory regulation or exceeds the permitted use, you will need to obtain permission directly from the copyright holder.





# High Strength and Electrical Conductivity of $\alpha$ -Al-CNTs + GAgNPs Nanocomposites

Victor Sunday Aigbodion<sup>1,2,3</sup> 

<sup>1</sup> Faculty of Engineering and Built Environment, University of Johannesburg, Auckland Park, P. O. Box 534, Johannesburg, South Africa

victor.aigbodion@unn.edu.ng

<sup>2</sup> Africa Centre of Excellence, ACESPED University of Nigeria, Nsukka, Nigeria

<sup>3</sup> Department of Metallurgical and Materials Engineering, University of Nigeria, Nsukka, Nigeria

**Abstract.** The development of new advanced material of  $\alpha$ -Al- carbon nanotubes (CNTs) and green synthesis silver nanoparticles (GAgNPs) superconductor nanocomposites was studied. Green synthesis silver nanoparticles (GAgNPs) was used for the decoration of CNTs. The composites were by modified spark plasma sintering (SPS). The microstructure, strength and electrical conductivity of the nanocomposites were determined. The formation of sub-grain in the Al-4% CNTs + 2% GAg.NPs composite generates more dislocation density. The addition of GAgNPs to Al-CNTs significantly enhanced the ductility mode of fracture associated with the AlAg<sub>3</sub>(110) and AlAg<sub>2</sub>(100) phases and the small sub-grain formed at the surface. It can be concluded that a higher strength, electrical conductivity can be made from the developed nanocomposite.

**Keywords:** Cashew leaves · electrical conductivity · strength · stress analysis · microstructure

## 1 Introduction

Effort has been made by the researcher to develop an aluminum conductor that has high strength and electrical conductivity [1]. A carbon nanotube (CNTs) is one of the nanoparticle's electrical conductive reinforcement that attracts researchers' attention due to the high electrical conductivity of CNTs on aluminum [2]. The mechanical properties, microstructure, and corrosion of Al-CNTs produced by spark plasma sintering were investigated by Ujah et al [3]. They observed higher strength overhead transmission conductor. Ujah et al [4] reported the electrical conductivity, thermal, wear properties, and microstructure of Al-CNTs produced by spark plasma sintering. They observed high wear resistance; electrical conductivity and thermal properties of overhead transmission conductor. Mansoor and Shahid [5] used the induction melting method to developed Al-CNTs. They observed 77 and 52% enhancement in yield and tensile strength.

Although with the high electrical conductivity and thermal of CNTs there is a dispersion of entanglement of the CNTs during the production and the high cost of CNTs limits

their use in electronic devices [6]. A great shear force is usually needed to help disperse CNTs and avoid entanglement in the metal matrix [7]. This limitation is still a challenge in the development of Al/CNTs composites. Ultrasonic cavitations, wet mixing, and metallic nanoparticles have been used to enhance the dispersion of CNTs in aluminum by decreasing the Van der Waals and hydrogen bond interactions. The addition of silver nanoparticles (AgNPs) [8] has been successful used with CNTs to produced conductive composites. Saif et al [9] reinforced on Al-1%CNTs with 0, 1, 2, 3,4% AgNPS and Cu. From the review above on the improvement of the electrical conductivity of Al/CNTs using AgNPs, it was cleared that AgNPs have a great potential in enhancing the properties of Al/CNTs. But the high demand and cost of AgNPs have been a major problem, which reduced the wide application of AgNPs to improves the properties of Al/CNTs [10–13]. However, in this work attempt was made to produce AgNPs using the biosynthesis method (Cashew leaves extract) to lower the cost of AgNPs used in the production of Al/CNTs.. Researchers [10, 11] have shown that the leaves extract from Cashew has anacardic acids which have been used as antibacterial agents (Ag+ to Ag) in the production of AgNPs [10]. The utilization of leaves extract from Cashew to produce Ag-nanoparticles will be less costly and environmentally friendly. Spark plasma sintering (SPS) was used in the production of the advanced composites. The choice of SPS in this work is regarding the ability to obtain high densification, save time, energy, and elimination coarse grain size [3, 4].

## 2 Methodology

The aluminum powder was purchased in Lagos Nigeria. The aluminum powder has 99.98% purity. A multi-walled CNTs with a diameter of 10–40 nm and length 10–20  $\mu$ m used in this work was obtained from Hongwu Company in China. Cashew leaves extract was put inside ethanol (100 ml) for one (1) hour and then 100 ml of AgNO<sub>3</sub> was then added to the ethanol solution and left for 30 min for reaction to take place. The samples and the solution were heated to a temperature of 100 °C under constant stirring of speed (2000 rpm). The centrifuge was then used to obtain the solid GAgNPs [10]. The particle size of the GAgNPs was 45 nm. Al-CNTs+2%GANPs were ball milled using a high-speed vibrating ball mill. The ball milling machine contains fifty (50) tungsten balls of 10mm diameter. The production of the advanced composites was done by a spark plasma sintering machine (SPS) (model: SPS10-3). A composite of Al-x%CNTs ( $x = 1, 2, 3, 4$ ) and constant 2%GAgNPs were produced. Kaise insulation test (model SK5010) was used to determine the electrical conductivity measurement of the composites. The microstructure obtained in the composites was determined using scanning electron microscope (SEM) model: A VEGA 3 TESCAN. The tensile test was done by ASTM D3039 using a Testometric universal testing machine.

## 3 Results and Discussion

The electrical conductivity of the samples is displayed in Figure 1. It was observed that there was a significant improvement in the electrical conductivity of Al-CNTs and Al-CNTs + GAgNPs. A linear increment in the electrical conductivity as the % of

CNTs and GAgNPs increases in the formulation was observed. The increment in the electrical conductivity of Al-GAgNPs+CNTs than Al-CNT was attributed to the higher electrical conductivity of GAgNPs [10] than that of the CNTs. The GAgNPs+CNTs can be used as a conducting reinforcement with a high aspect ratio with lower contact resistance at CNTs junctions. The electrical conductivity of the  $\alpha$ -Al has been enhanced from  $2.18 \times 10^7$ S/cm to  $2.35 \times 10^7$  S/cm for Al-4%CNTs and  $4.21 \times 10^7$  S/cm for Al-4%CNTs-2%GAgNPs respectively. A 7.8% and 93.11% raise in the electrical conductivity achieved at Al-4%CNTs and Al-4%CNTs-2%GAgNPs over that of Al-matrix. The work had shown a higher electrical conductivity than the work of Ujah et al [4] that reported  $2.27 \times 10^7$ S/cm for Al-4%CNTs composite. The addition of 2%GAg.NPs to Al-4%CNTs can be used in the production of high-tension transmission conductors.

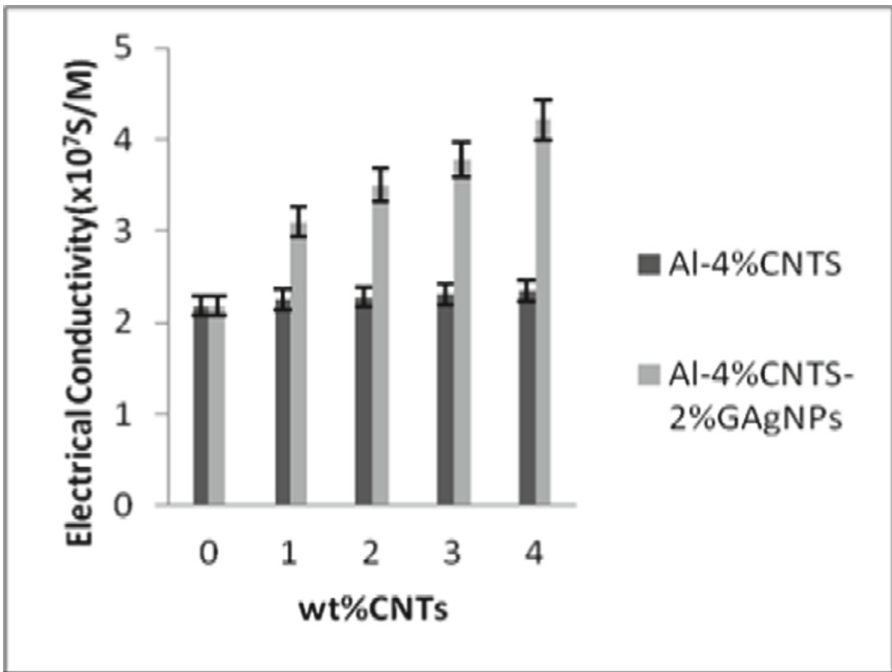
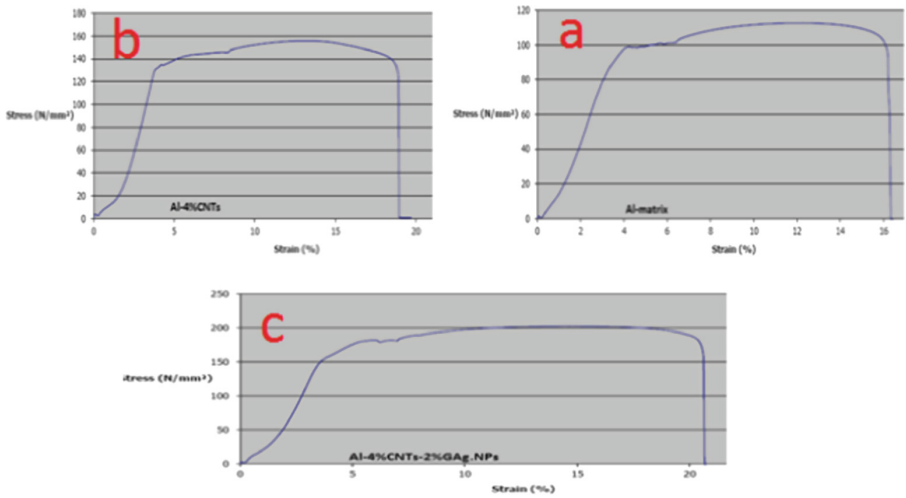


Fig. 1. Electrical Conductivity with percentage of CNTs

The stress-strain curves were obtained for the Al-matrix, Al-4%CNTs, Al-4%CNTs+2%GAgNPs are displayed in Fig. 2. In Fig. 2, it was evident that the pure Al has the lowest region under the stress-strain curve than the composites (compared Fig. 2a with Fig. 2b-c). That means that the nanocomposites have higher toughness than the pure Al as revealed by the values of energy absorbed before fracture and percentage of strain (Table 1). The stiffness of Al-matrixes was enhanced as a result of the addition of CNTs +GAgNPs. Al-4%CNTs+2%GAgNPs have a higher strength of all the samples. For example, a tensile strength of 113.43, 157.70, and 206.60MPa were obtained for the

Al-matrix, Al-4%CNTs, Al-4%CNTs+2%GAgNPs, respectively. An 82.14% enhancement in tensile strength was recorded at Al-4%CNTs+2%GAgNPs over pure Al. The fracture mechanism of the tensile strength was done by SEM analysis. From the SEM images displays in Figure 3, it was revealed that the fracture mechanism of the  $\alpha$ -Al consists of a mixture of both brittle-ductile fractures with transgranular cleavage and tear with ridges (Figure 3a). The nanocomposites have a different mode of fracture from the  $\alpha$ -Al. The nanocomposite carbon particles with intercrystalline, without delamination of the particles at interfaces were observed for the Al-4%CNTs nanocomposite (Figure 3b). The addition of 2%GAgNPs to Al-4%CNTs significantly enhances the ductility mode of fracture (Figure 3c).

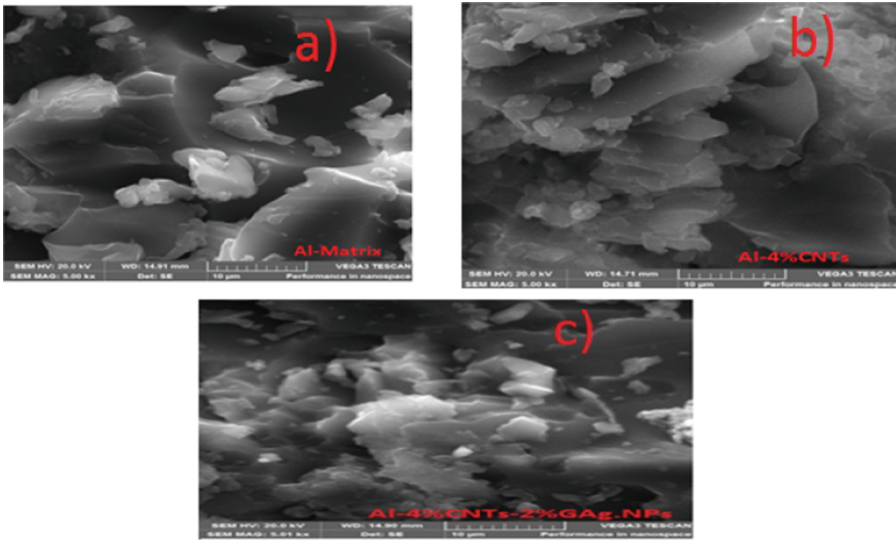


**Fig. 2.** Variation of stress versus strain of the samples a) pure aluminum b) Al-4%CNTs c) The addition of Al-4%CNTs + 2%GAgNPs.

**Table 1.** Results of the tensile properties.

Samples	EM(MPa)	YS(MPa)	TS(MPa)	SB(%)	EB(N.M)	ELB(mm)
Al-matrix	2891.34	98.57	113.43	16.46	356.89	28.45
Al-4%CNTs	3987.21	143.56	157.70	19.70	598.26	35.68
Al-4%CNTs-2%GAg.NPs	4890.35	198.50	206.80	20.78	639.56	38.89

EM: elastic modulus, YS: yield strength, TS: tensile strength, SB: strain at break, EB: energy at break, ELB: elongation at break.



**Fig. 3.** Fracture surface of the tensile samples: a) pure aluminum b) Al-4%CNTs c). The addition of Al-4%CNTs + 2%GAgNPs

## 4 Conclusions

A new nanocomposites Al-CNTs + GAgNPs was developed using the biosynthesis AgNPs from Cashew leaves extract to decorated CNTs. it can be concluded that: Al-GAgNPs + CNTs can be used to conduct reinforcement with a high aspect ratio with lower contact resistance at CNTs junctions. 7.8% and 93.11% raises are obtained the electrical conductivity of Al Al-4%CNTs and Al-4%CNTs + 2%GAgNPs composites. An 82.14% enhancement in tensile strength was recorded et al.-4%CNTs + 2%GAgNPs over pure Al. High tension conductor application can be made with these materials since the values of strength and factor of safety are within the recommended standard.

## 5 Disclosure Statement

*Conflict of Interest:* The authors declare that there are no conflicts of interest.

**Acknowledgement.** The author hereby appreciates and acknowledge the Africa Centre of Excellence for Sustainable Power and Energy Development, ACE-SPED, University of Nigeria, Nsukka, Energy materials research group, University of Nigeria, Nsukka, Nigeria, Faculty of Engineering and Built Environment, University of Johannesburg, Auckland Park, South Africa for their support.

## References

1. Park, S.H., et al.: Modeling the electrical resistivity of polymer composites with segregated structures. *Nature Commun.* **10**, 2537 (2019). <https://doi.org/10.1038/s41467-019-10514-4>
2. Bandaru, P.R.: Electrical properties and applications of carbon nanotube structures. *J. Nanosci. Nanotechnol.* **7**, 1239–1267 (2007). <https://doi.org/10.1166/jnn.2007.307>
3. Ujah, C.O., Popoola, A.P.I., Popoola, O.M., Aigbodion, V.S.: Influence of CNTs addition on the mechanical, microstructural, and corrosion properties of Al alloy using spark plasma sintering technique. *Int. J. Adv. Manuf. Technol.* **106**, 2961–2969 (2020). <https://doi.org/10.1007/s00170-019-04699-7>
4. Ujah, C.O., Popoola, A.P.I., Popoola, O.M., Aigbodion, V.S.: Enhanced tribology, thermal and electrical properties of Al-CNT composite processed via spark plasma sintering for transmission conductor. *J. Mater. Sci.* **54**, 14064–14073 (2019). <https://doi.org/10.1007/s10853-019-03894-x>
5. Mansoor, M., Shahid, M.: Carbon nanotube-reinforced Aluminum composite produced by induction melting. *J. Appl. Res. Technol.* **14**, 215–224 (2016). <https://doi.org/10.1016/j.jart.2016.05.002>
6. Mohammed, S.M., Chen, D.L.: Carbon nanotube-reinforced Aluminum matrix composites. *Adv. Eng. Mater.* **22**, 1901176 (2020). <https://doi.org/10.1002/adem.201901176>
7. Zhang, X.M., Yang, X.L., Wang, K.Y.: Electrical conductivity enhancement of epoxy by hybrid carbon nanotubes and self-made silver nanoparticles. *Fibers Polym.* **20**(7), 1480–1485 (2019). <https://doi.org/10.1007/s12221-019-8640-6>
8. Saif, S.S., Ahmed, S.R., Annaz, A.A.: Mechanical performance of micro-Cu and Nano-Ag reinforced Al-CNT composite prepared by powder metallurgy technique. *Mater. Res. Express* **6**, 105071 (2019)
9. Sharma, M., Pal, H., Sharma, V.: Electrical conductivity and thermal expansion measurement of Nanocrystalline aluminum reinforced with functionalized multiwall carbon nanotubes. *Int. J. Chem. Tech. Res.* **6**, 2057 (2014)
10. Aritonang, H.F., Koleangan, H., Wuntu, A.D.: Synthesis of silver nanoparticles using aqueous extract of medicinal plants' (impatiens Balsamina and Lantana Camara) fresh leaves and analysis of antimicrobial activity. *Int J Microbiol* **2**, 8642303 (2019)
11. Hemlata Meena, P.R., Singh, A.P., Tejavath, K.K.: Biosynthesis of silver nanoparticles using Cucumis Prophetarum aqueous leaf extract and their antibacterial and Antiproliferative activity against cancer cell lines. *ACS Omega* **5**, 5520–5528 (2020)
12. Ashok Gandhi, R., Jayaseelan, V., Palani Kumar, K., Raghunath, B.K., Krishnaraj, S.: Effect of carbon nano tubes (CNT) on hardness of polypropylene matrix. In: Lakshminarayanan, A., Idapalapati, S., Vasudevan, M. (eds.) *Advances in Materials and Metallurgy. Lecture Notes in Mechanical Engineering*, pp. 261–270. Springer, Singapore. [https://doi.org/10.1007/978-981-13-1780-4\\_26](https://doi.org/10.1007/978-981-13-1780-4_26)
13. Gandhi, R.A., Jayaseelan, V., Raghunath, B.K., Palanikumar, K., Ramachandran, S.: Nano indentation hardness testing of PP-CNT Composites. *Mater. Today: Proc.* **16**, 1372–1377 (2019)



**Open Access** This chapter is licensed under the terms of the Creative Commons Attribution 4.0 International License (<http://creativecommons.org/licenses/by/4.0/>), which permits use, sharing, adaptation, distribution and reproduction in any medium or format, as long as you give appropriate credit to the original author(s) and the source, provide a link to the Creative Commons license and indicate if changes were made.

The images or other third party material in this chapter are included in the chapter's Creative Commons license, unless indicated otherwise in a credit line to the material. If material is not included in the chapter's Creative Commons license and your intended use is not permitted by statutory regulation or exceeds the permitted use, you will need to obtain permission directly from the copyright holder.





# Material Recycling of End-of-Life Tires: The Influence of Recyclates on the Processing of Rubber Compounds

Stefan Hoyer<sup>1</sup>(✉) and Lothar Kroll<sup>1,2</sup>

<sup>1</sup> Chemnitz University of Technology, 09126 Chemnitz, Germany

stefan.hoyer@mb.tu-chemnitz.de

<sup>2</sup> Opole University of Technology, 45-271 Opole, Poland

**Abstract.** The paper focuses on the recycling of end-of-life tires (ELTs) by admixing ELT recyclates to rubber compounds. It deals with the physical and chemical interactions resulting from the admixture of finely ground powder from end-of-life tires to a sulfur-cured rubber compound. Using exemplary rubber recipes, the effects of viscosity increase, accelerated crosslinking and stiffness decrease are quantified and the underlying reasons are explained.

**Keywords:** circular economy · elastomer · sulphur migration · accelerated scorch

## 1 Introduction

End-of-life tires (ELTs) are a waste stream of high relevance in terms of quantity. Today, only a very small portion is recycled into new tires. The average share of ELT recyclates across all components of a tire is about 3% [1, 2]. In addition to being used to modify bitumen for road construction or thermal recovery, ELTs are granulated and pressed with adhesives to form molded parts. Polyurethane is often used as a binder. Processing is relatively simple, but such materials achieve only moderate mechanical properties. The highest-quality form of recycling appears to be the admixture of finely ground ELT recyclate to rubber compounds. Here, it is often possible to achieve characteristic properties equal to those of primary raw materials. However, this route is rarely used today, especially because a number of interactions occur in the process. The diffusion of chemicals between the recyclate and the rubber compound is the major factor to be mentioned here. This influences the crosslinking reaction and thus both the processing behavior and the crosslinking density of the resulting materials. These systemic interactions are often unpredictable even for experts in the field and pose high hurdles for the utilization of ELT recyclates in the rubber industry. The research question of the work presented here was the qualitative and quantitative influence of ELT recyclates on rubber compounds. In this paper, these effects are presented and quantified using exemplary natural rubber compounds crosslinked with  $\alpha$ -sulfur and a sulfenamide accelerator. The intent is to demonstrate the unusual effects to experts in compound development and process engineering and to facilitate targeted introduction of recycling applications.

## 2 General Influence on Material Behavior

First, an overview of the basic influence of the ELT material on the material behavior of rubber compounds will be given. Different amounts of rubber powder as well as different grain sizes were admixed to a rubber compound and the material behavior was characterized by means of crosslinking curves.

The ELT material was provided by Mülsener Rohstoff- und Handelsgesellschaft MRH (Table 1). It originates from truck tires, produced by ambient (suffix “W”) respectively cryogenic grinding (“K”). The material differs by its particle size (mesh size). The ratio of surface area to mass is calculated based on an idealized spherical shape and a density of  $1.15 \text{ g/cm}^3$ . It is only a rough approximation, because ELT material typically shows fractal surfaces and ambient and cryogenic ground materials differ in their specific surface area, which is usually larger for ambient ground material [3].

**Table 1.** Overview of the ELT materials used

ELT material	Mesh size [ $\mu\text{m}$ ]	Average size [ $\mu\text{m}$ ]	Average mass [mg]	Average surface area [ $\text{mm}^2$ ]	Area per mass [ $\text{cm}^2/\text{g}$ ]
K0204	200–400	300	0.0163	0.283	173.9
W0610	600–1000	800	0.308	2.011	65.2
W0520	500–2000	1250	1.176	4.909	41.7

The basic rubber compound into which the ELT material was incorporated is a sulfur-cured, sulfenamide-accelerated natural rubber (Table 2). Soluble  $\alpha$ -sulfur was applied for all experiments. Tests with insoluble  $\mu$ -sulfur did not yield to any significant differences. The mixtures were named according to the mass content  $w_P$  of ELTs. The preparation of mixtures was carried out with a laboratory kneader Brabender Plasticorder (rotor N50, temperature  $50 \text{ }^\circ\text{C}$ , rotor speed 50 rpm, filling degree 0.75). The crosslinking was measured approximately 21 h after mixture preparation with a moving die rheometer (MDR, MonTech D-RPA 3000) at a temperature of  $150 \text{ }^\circ\text{C}$ , a frequency of 1.67 Hz and an amplitude of  $0.5^\circ$ .

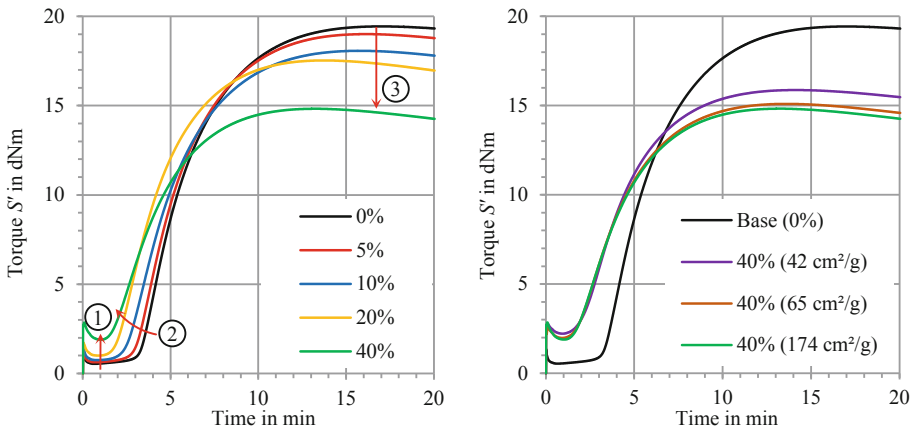
Figure 1, left, shows crosslinking curves at various content of cryogenic ground ELTs (K0204). Three characteristic changes in the rubber compounds result, which are more pronounced with increasing ELT content:

1. The minimum elastic torque  $S'_{min}$  increases, thus the viscosity rises.
2. The crosslinking reaction starts earlier without significantly affecting the crosslinking time until the maximum torque  $S'_{max}$ .
3. The maximum elastic torque  $S'_{max}$  decreases. This is due to a lower elastic shear modulus of the rubber and, above all, a result of a lower crosslink density.

**Table 2.** Recipe of the rubber mixtures. Indication in phr (per hundred rubber)

Component	0%	5%	10%	20%	40%
NR SVR CV 50	100	100	100	100	100
SPHERON® 6-LP	30	30	30	30	30
Stearic acid	3	3	3	3	3
Zinc oxide	5	5	5	5	5
CBS	1	1	1	1	1
Sulphur (90/95)	4	4	4	4	4
ELT material	0	7.5	16	36	95

Figure 1, right, shows the influence of different mesh sizes of the ELT recyclates at a mass fraction  $w_P$  of 40%. There is a tendency for both the minimum (1) and the maximum torque (3) to rise slightly with increasing mesh size.



**Fig. 1.** Crosslinking behavior as a function of ELT content (K0204, 174 cm<sup>2</sup>/g) (left) and particle size at an ELT content of 40% (right)

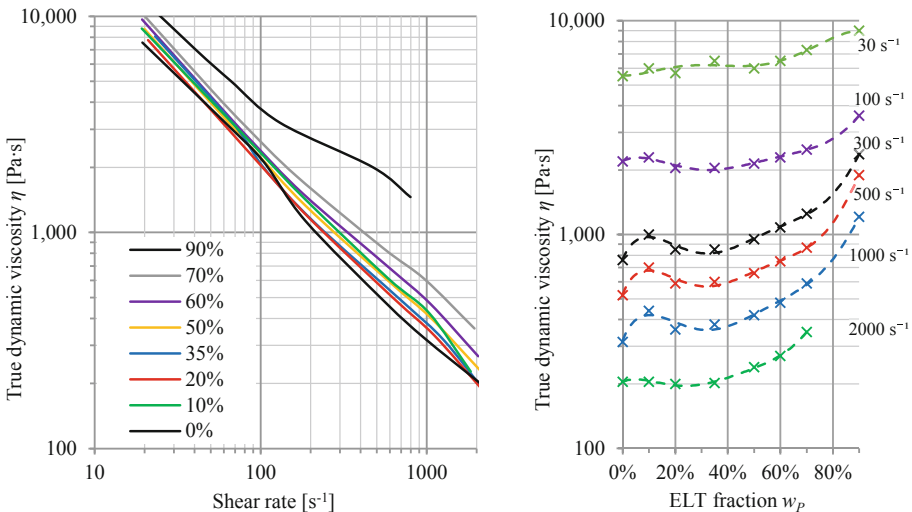
### 3 Increase of Viscosity

As shown by (1) of Fig. 1, left, the viscosity of rubber compounds increases when ELT particles are admixed. This is particularly relevant for the processability with calendering, injection molding or extrusion. A sharp increase in viscosity, for example, often leads to high, pulsating pressure and temperature peaks during extrusion.

In order to exemplarily quantify the influence of ELT material on the flow behavior, the shear rate  $\dot{\gamma}$  dependent viscosity  $\eta$  was measured. Therefore, different proportions of ELT material were admixed to an unfilled natural rubber (type “first latex crepe”

provided by Wagu Gummitechnik GmbH). The ELT material was K0204 according to Table 1 and was admixed in proportions of 10 to 90% to the matrix. The measurement of the true dynamic viscosity  $\eta$  was carried out with a high-pressure capillary viscometer (HPCV) GÖTTFERT Rheograph RG25 at a temperature of 80 °C. The measurements were adjusted by the Bagley and the Weissenberg-Rabinowitsch correction.

Figure 2 illustrates the influence of ELT powder (K0204, 200–400  $\mu\text{m}$ ) on the true dynamic viscosity  $\eta$ . On the left, the viscosity is shown as a function of shear rate for various ELT contents up to 90%. On the right, viscosity is shown as a function of ELT content for selected shear rates, relevant for calendering, extrusion and injection molding. The viscosity rises with increasing recycle content, which is more pronounced at higher shear rates (the divergence of the 10% curve was confirmed by a double measurement). According to Fig. 2, right, the increase as a function of ELT content is approximately exponential. In practice, the increase in viscosity is frequently already so pronounced at 30% recycled content that problems or productivity reductions can occur during calendering or extrusion. However, the compound retains some flowability up to and including 90% ELTs.



**Fig. 2.** True dynamic viscosity of ELT/caoutchouc compounds at 80 °C as a function of shear rate for variable ELT content  $w_p$  (left) and ELT content for selected shear rates (right)

## 4 Accelerated Scorch and Reduction of Crosslink Density

### 4.1 Preliminary Consideration

As shown in (2) and (3) of Fig. 1, left, with increasing ELT content, the maximum torque decreases and the crosslinking reaction starts earlier. Both phenomena are most likely due to a mutual diffusion of chemicals. It can be assumed that these effects do not

necessarily occur in every case, but depend on the formulation of the rubber compound and in particular on the crosslinking system used. However, the effects described were observed in varying degrees in many of the author's tests to date.

#### 4.2 Decrease of Maximum Torque Due to Sulfur Migration

Once ELT material is admixed into a rubber compound, sulfur diffuses from the rubber compound into the ELT particles [4]. Basically, a diffusion of sulfur from higher to lower concentration takes place, whereby the sulfur bound in crosslink bridges in the ELT material no longer seems to be relevant at that point. Furthermore, in the case of the presence of different caoutchouc types, the chemicals migrate more quickly to the phase with the lower glass transition temperature. This diffusion leads to a depletion of sulfur in the rubber compound and a corresponding reduction in the crosslink density. As a result, the vulcanizate shows a lower elastic shear modulus, which is reflected in the form of a lower maximum of the elastic torque ( $S'_{\max}$ ).

**Compensation of Sulfur Migration.** To counteract sulfur migration, the content of sulfur (S) and accelerator (CBS) in the base rubber compound should be increased [5]. Figure 3 shows the crosslinking and deformation behavior of rubber compounds with 40% ELT material at different levels of S and CBS. When ELT material is admixed to the base compound without any change in its S and CBS content (1), the elastic shear stiffness (maximum torque  $S'_{\max}$ ) drops. This is also associated with a decrease in SHORE hardness from 65 to 57 SHORE A.

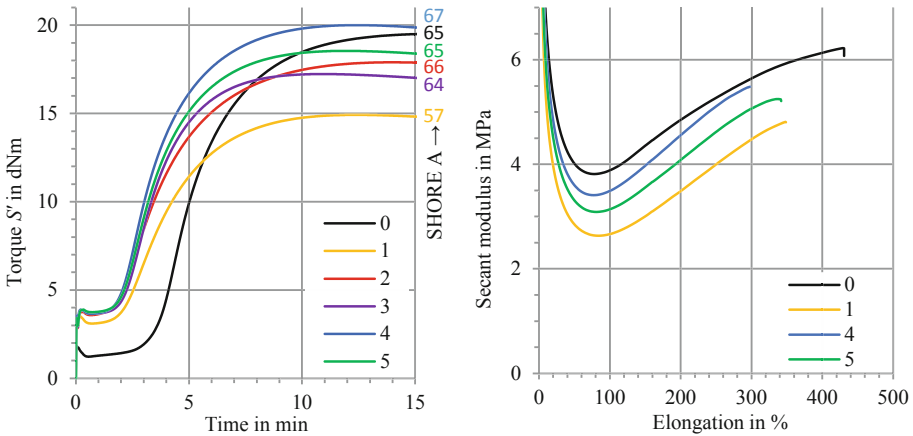
In this context, it is occasionally recommended in literature to take the caoutchouc content of the ELT material into account when dimensioning the crosslinking system [6]. The average caoutchouc content of ELTs is about 45%. Therefore, with 100 phr caoutchouc in the base compound and an admixture of 100 phr ELT, S and CBS would have to be increased to 1.45 times. This is the case for mixture (4) of Table 3. For mixture (2), only S was increased accordingly, and for (3), only CBS. For (5), S and A were increased only by half of that, thus to 1.23 times.

Figure 3 shows the influence of increasing the S and CBS content. On the left side crosslinking curves are shown, which were determined analogously to Chapter 2. On the right side, the stiffness (secant modulus) of selected samples is displayed (measured according to DIN 53504, S2, 200 mm/min). It is found that both  $S'_{\max}$  and SHORE hardness can be raised back to the level of the initial mixture (base) in this way.

However, looking at mixture (4), the following can be observed: This mixture has a slightly higher SHORE hardness and  $S'_{\max}$  than (base). According to Fig. 3, right, the material nevertheless shows a lower stiffness in tensile test when compared to mixture (base). In consequence, this implies that even this compensation does not necessarily achieve the identical material behavior of the initial compound. A comprehensive empirical optimization is usually required to bring ELT/rubber compounds into the target window, and it is necessary to focus on one specific parameter, such as SHORE hardness or stiffness. Furthermore, even with identical formulations of the base compound and the recyclates, it must be assumed that, as a result of sulfur migration and the potential additional crosslinking of the recyclates, such compounds might always possess two phases with different stiffness characteristics [7].

**Table 3.** Recipe of the rubber mixtures. Indication in phr (per hundred rubber)

Component	Base	1	2	3	4	5
NR SVR CV 60	100	100	100	100	100	100
SPHERON® SO-LP	40	40	40	40	40	40
Stearic acid	2	2	2	2	2	2
Zinc oxide	5	5	5	5	5	5
CBS C	1	1	1	1.45	1.45	1.23
Sulphur (90/95)	3	3	4.35	3	4.35	3.68
ELT material (K0204)	0	100	100	100	100	100
SHORE A	65	57	66	64	67	65

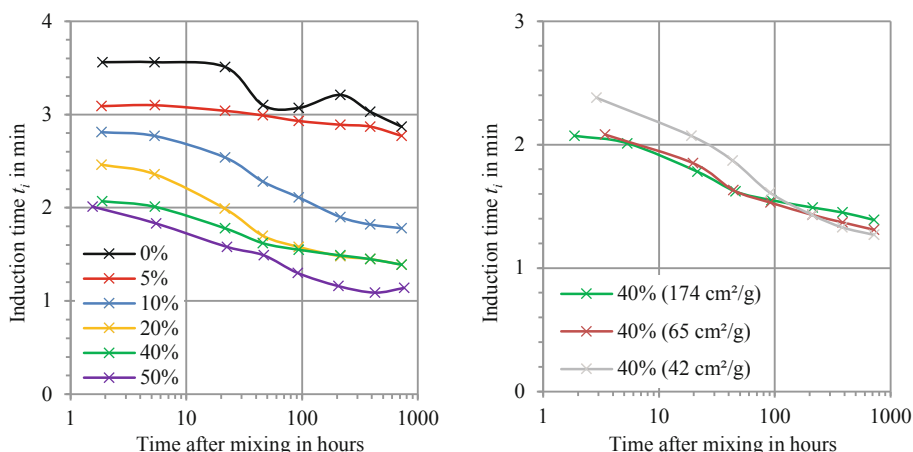
**Fig. 3.** Influence of the sulfur and accelerator content for 40% ELT content on the crosslinking behavior (left) and the secant modulus (DIN 53504, S2, 200 mm/min) (right)

### 4.3 Accelerated Scorch

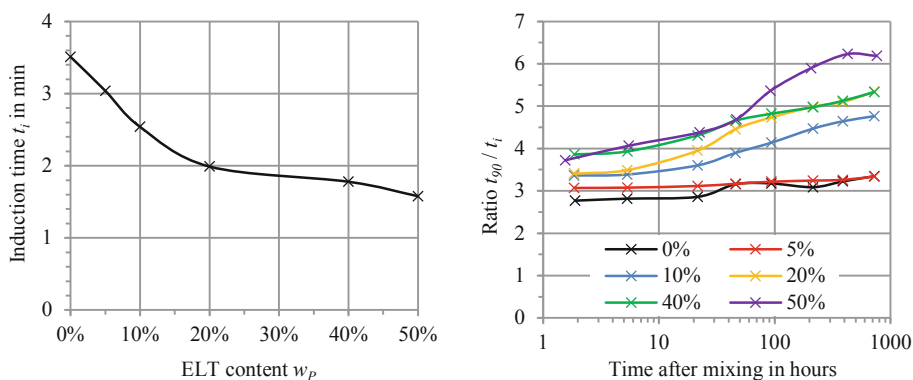
The induction phase is the time prior to actual crosslinking and is therefore crucial for the processing time at a specific temperature. Before crosslinking begins, the complexes important for sulfur transfer are formed during the induction time (scorch phase). Sulfenamide accelerators react with zinc oxide and sulfur to form an active sulfur-accelerator complex, which determines the duration of the induction phase. This is followed by the transfer of the sulfur to the rubber. In this context, it seems plausible that such sulfur-accelerator complexes diffuse from the ELT material to the rubber matrix and lead to a premature start of crosslinking [7].

Figure 4, left, shows the influence of the amount of rubber powder (K0204) on the accelerated scorch of the mixtures according to Table 2. The right side shows the influence of different particle sizes at a filling ratio  $w_P$  of 40%. The reduction in induction time occurs immediately after mixing, and there is an additional time-dependent decrease.

This time dependent decline can also be observed for the compound (base). However, for the ELT compounds, the ratio of the time  $t_{90}$ , required to reach 90% of  $S'_{\max}$ , over the induction time  $t_i$  deteriorates significantly (see Fig. 5, right). The crosslinking reaction thus starts earlier, but without significantly influencing the overall crosslinking time. The processing window thus becomes smaller without significantly reducing the total cycle time. An influence of the particle size is present at the beginning (Fig. 4, right), but equalizes after about 100 h. This supports the hypothesis that these are diffusion processes which require a prolonged time for longer diffusion paths or low specific surface area. Finally, Fig. 5, left, shows the induction time 21 h after mixing as a function of  $w_p$ .



**Fig. 4.** Induction time at 150 °C as a function of storage time after mixing with various ELT content (K0204) (left) and various particle size for an ELT content of 40% (right)



**Fig. 5.** Induction time of rubber compounds at 150 °C, 21 h after mixing, as a function of ELT content (K0204) (left) and ratio of the time  $t_{90}$  required to reach 90% of  $S'_{\max}$  over the induction time  $t_i$  as a function of the time elapsed after mixing (right)



#### 4.4 Summary

A number of physical and chemical interactions occur when end-of-life tire recyclates are admixed to sulfur-cured rubber compounds.

In practice, the increase in viscosity often leads to reduced productivity in extrusion. The financial benefits of ELT recyclates, which would be the main consideration in many applications, are therefore often outweighed. Additional flow additives therefore have to be used in many cases, which also has a negative impact on costs.

Sulfur migration has to be counteracted at higher ELT contents by increasing the sulfur and accelerator content in the base compound. However, this results in a considerable increase in the total sulfur content of the elastomers. Furthermore, materials are produced with two phases of potentially different stiffness and with a partially altered deformation behavior, which is increasingly determined by the properties of the tire compounds as the ELT content increases.

If accelerated scorch is problematic in the given manufacturing process, it can be counteracted by lowering the crosslinking temperature. However, this results in increasing cycle times. Even the use of retarders can only compensate for this effect to a very limited extent. Initial preliminary tests showed very limited efficiency and were not considered in this paper.

## 5 Conclusions

The addition of recyclate to rubber compounds leads to atypical changes in processing characteristics, often surprising even to the expert. Their systemic correlations pose a challenge for material development and involve a considerable amount of work. In order to expand the material recycling of elastomers, it therefore appears appropriate to study the effects described here in depth and to systematize them in order to ultimately facilitate the implementation of recycling in existing rubber compounds and to initiate the development of new compounds that are unaffected by such effects.

## References

1. Röthemeyer, F., Sommer, F.: *Kautschuktechnologie*, vol. 3, p. 1221. Auflage, München (2013)
2. Kleemann, W.: *Mischungen für die Elastverarbeitung*, p. 282. VEB Deutscher Verlag für Grundstoffindustrie, Leipzig (1982)
3. Hoyer, S., Kroll, L., Sykutera, D.: Technology comparison for the production of fine rubber powder from end of life tyres. *Procedia Manuf.* **43**, 193–200 (2020)
4. Herrmann, V., et al.: Untersuchungen zur diffusion des Schwefels in Rezyklat-Kautschukmischungen. In: *GAK Gummi Fasern Kunststoffe*, vol. 71, pp. 340–349 (2018)
5. Phadke, A.A., Bhowmick, A.K., De, S.K.: Effect of cryoground rubber on properties of NR. *J. Appl. Polym. Sci.* **32**(3), 4063–4047 (1986)
6. Schieling, E.: *Altgummimehl enthaltende Kautschukvulkanisate hoher Rissbeständigkeit*. Patent DE 2137891 A (1973)
7. Hoyer, S.: *Neuartige Warmmahltechnologie zum Recycling von Elastomeren und Analyse prozessbedingter Eigenschaften*. Dissertation, Chemnitz (2014)

**Open Access** This chapter is licensed under the terms of the Creative Commons Attribution 4.0 International License (<http://creativecommons.org/licenses/by/4.0/>), which permits use, sharing, adaptation, distribution and reproduction in any medium or format, as long as you give appropriate credit to the original author(s) and the source, provide a link to the Creative Commons license and indicate if changes were made.

The images or other third party material in this chapter are included in the chapter's Creative Commons license, unless indicated otherwise in a credit line to the material. If material is not included in the chapter's Creative Commons license and your intended use is not permitted by statutory regulation or exceeds the permitted use, you will need to obtain permission directly from the copyright holder.



# **Additive Manufacturing**



# Potential Analysis for the Use of Bio-Based Plastics with Natural Fiber Reinforcement in Additive Manufacturing

Andreas Friedel<sup>(✉)</sup>  and Stefan Junk 

Offenburg University of Applied Sciences, Campus Gengenbach, Klosterstr 14,  
77723 Gengenbach, Germany  
andreas.friedel@hs-offenburg.de

**Abstract.** Plastics are used today in many areas of the automotive, aerospace and mechanical engineering industries due to their lightweight potential and ease of processing. Additive manufacturing is applied more and more frequently, as it offers a high degree of design freedom and eliminates the need for complex tools. However, the application of additively manufactured components made of plastics have so far been limited due to their comparatively low strength. For this reason, processes that offer additional reinforcement of the plastic matrix using fibers made of high-strength materials have been developed. However, these components represent a composite of different materials produced on the basis of fossil raw materials, which are difficult to recycle and generally not biodegradable.

Therefore, this paper will explore the potential for new composite materials whose matrix consists of a bio-based plastic. In this investigation, it is assumed that the matrix is reinforced with a fibrous material made of natural fiber to significantly increase the strength. This potential material should offer a lightweight yet strong structure and be biodegradable after use under controlled conditions. Therefore, the state of the art in the use of bio-based materials in 3D printing is first presented. In order to determine the economic boundary conditions, the growth potentials for bio-based materials are analyzed. Also, the recycling prospects for bio-based plastics will also be highlighted. The greenhouse gas emissions and land use to be expected when using bio-based materials are also estimated. Finally, the degradability of the composites is discussed.

**Keywords:** Additive manufacturing · Fiber reinforcement · Natural fibers · Degradability · Bio-based plastics

## 1 Introduction

Alongside metals and minerals, plastics are the most commonly used materials in additive manufacturing. The main advantages are their ease of processing, moderate material costs and low weight [1]. However, the areas of application for additively manufactured components made of plastics have so far been limited due to their comparatively low strength. For this reason, processes that offer additional reinforcement of the plastic

matrix with short and long fibers made of high-strength materials (e.g. glass or carbon fibers) have been used for some time. Very high strengths can be achieved in particular by inserting long fibers made of carbon [2]. This makes it possible to additively manufacture highly resilient and at the same time lightweight components that are used, for example, in vehicle and aircraft construction. However, these components represent a composite of different materials produced on the basis of fossil raw materials, which is difficult to recycle and generally not biodegradable.

Therefore, the question arises as to how these conventional materials can be replaced by bio-based and biodegradable materials? In particular, it must be clarified which material properties the biomaterials can offer? In addition, it is of great interest which economic and ecological consequences the use of biomaterials has?

In this contribution, the potential of a new composite material is investigated, the matrix of which consists of a bio-based plastic. In this investigation, it is assumed that the matrix is reinforced with a fiber material made of natural fibers to significantly increase the strength. Both short and particularly long fibers can be used. The goal is to determine the technical, economic, and environmental potential for developing a bio-based composite material for additive manufacturing. This potential material should have a lightweight yet strong structure and be biodegradable after use under controlled conditions. In addition to the economic potential, the environmental impacts that may arise with the industrial use of bio-based materials will be investigated. In particular, land grabbing in subtropical and tropical wetlands and the associated reduction in biodiversity as well as competition with food cultivation are to be contrasted with the saving of fossil resources and the reduction of the greenhouse effect.

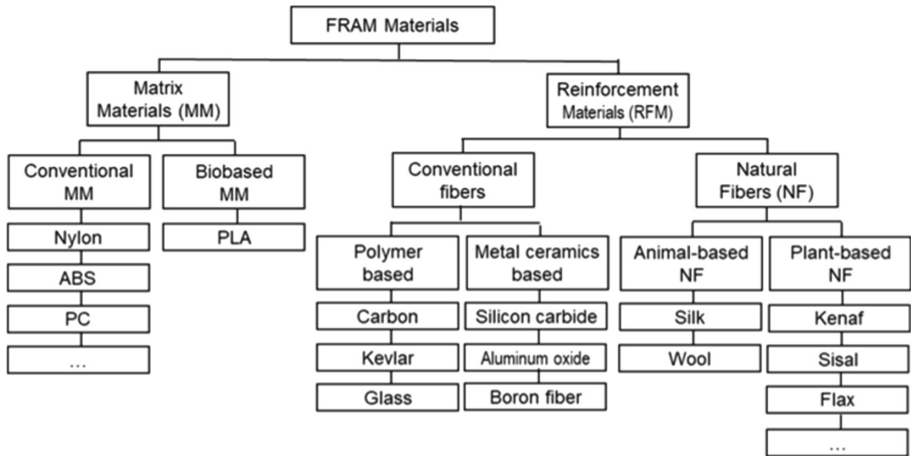
## 2 Investigation of Potential Composite Materials

Composites based on plastics and fibers open up great potentials, since the properties of the individual components can be surpassed in the composite of a plastic and a fiber. The fibers represent the load-bearing component embedded in the plastic [3]. The matrix material plays an important role in the composite by holding the fibers in place, transferring stresses between the fibers, protecting the fibers from adverse environmental conditions, preventing surface abrasion, and supporting the fibers under compressive loads [4]. The combination of Additive Manufacturing and fiber reinforcement opens up a new field of fiber-reinforced Additive Manufacturing (FRAM). The materials used in this process are shown in Fig. 1.

### 2.1 Matrix Materials

When selecting the matrix material, attention should be paid to compatibility with the reinforcing fibers. For thermal compatibility between matrix and fibers, it is important that the thermal expansion coefficients are relatively similar so that cracks or delamination between matrix and fibers do not occur during temperature fluctuations. A good bond between fiber and matrix is the basis for physical compatibility. Similarly, mechanical stress should not cause the two composite partners to separate. If the two materials do not react chemically, there is also chemical compatibility over a long period of time.

This ensures that both materials retain their desired properties over the entire life of the component [4]. On the one hand, composites offer many possible combinations of different plastic and fiber materials, and on the other hand, material properties such as strength and stiffness can be specifically adjusted by the quantity, position, length and orientation of reinforcements fibers. The highest reinforcement is achieved when the fibers are continuous and run in the direction of the load (long fibers). Therefore, material properties can vary not only between components but also within a component [3].



**Fig. 1.** Overview of possible matrix and reinforcement materials in fiber-reinforced additive manufacturing (FRAM) (based on [4])

## 2.2 Potential Reinforcement Materials

Basically, fibers used for reinforcement should be thin and flexible to allow easy insertion into the matrix material. In addition, they must also have high strength and elasticity in order to be able to compensate for the shortcomings of the matrix material. For many years, glass fibers and carbon fibers have been used for this purpose because they offer extremely high strength. In addition, natural fibers (NF) have also been incorporated for some years. These include both animal-based natural fibers (e.g. wool or silk) and plant-based fibers (e.g. kenaf, sisal, etc.), which are the focus of this contribution. Both types of NF offer some advantages over conventional fibers, such as low cost and good recyclability [5]. Natural fiber can also offer some advantages in processing, such as significantly reduced abrasion of nozzles in additive manufacturing. Possible disadvantages of natural fibers include limited strength and low melting point, as well as possible moisture absorption, which can limit processability [6]. To overcome the disadvantages, some treatment methods for natural fibers have already been developed. These include, for example, bleaching of the fibers to improve the mechanical properties [6, 7].

### 3 Additive Manufacturing Using Reinforcing Fibers (FRAM)

A high degree of flexibility in production is provided by Additive Manufacturing (AM). These processes are characterized by the fact that components are manufactured generatively in layers and directly without tools. This enables the individual design of components with a wide range of geometric complexity [4]. The fused filament method (FLM) has proven to be a particularly simple and robust process, which is also significantly more cost-effective than laser-based processes. In AM, conventional materials such as ABS or nylon are primarily used. In addition, bio-based materials such as PLA are also used, which can also be used as a matrix material in a composite material. The processing of continuous fibers within the FLM process is a new approach in AM, which has so far been used commercially primarily for the incorporation of conventional fibers. Different technologies are used, which differ mainly in how the strands of continuous fibers are impregnated and how these fibers are processed with the matrix materials [8]. Currently, the most common way to process short fibers with the FLM process is to incorporate the fibers into the filament of the matrix material. All axes of the 3D printer are driven by stepper motors. While the X and Y axes and thus also the print head move according to the paths calculated by the slicer software, the filament with the matrix material is feed in the nozzle, melted and deposited on the building platform. This builds up the component layer by layer. If a long fiber is to be processed in addition to the filament, another motor is used to convey the fiber. First a layer of plastic is extruded and then the fiber is laid over it in the desired orientation. [9].

### 4 Economic and Environmental Considerations

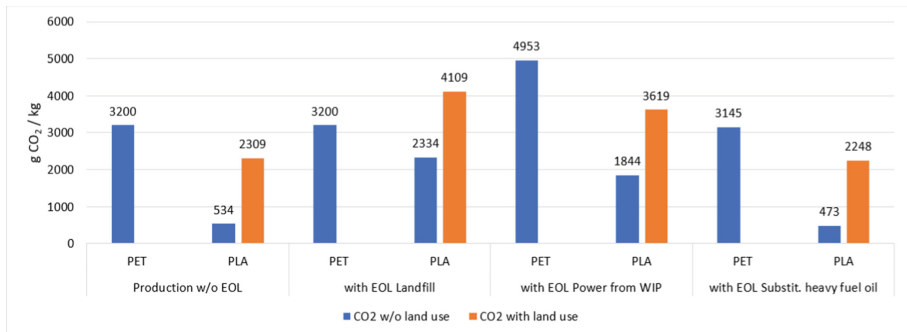
The total global market for composite plastics in 2021 was 12.1 million tons, almost back to the level of 2018 [10]. The share of thermoplastic composites is over 50%. The European market has a share of approx. 25%. The share of biodegradable bio-based plastics in the overall plastics market is still below 1% [12]. Production capacities for PLA are estimated to have tripled since 2016 [4]. At the same time, a market survey forecasts an 8-fold growth in ten years to over 9 billion USD in 2028 for the additive manufacturing market with fiber-reinforced plastics [13]. Both developments, as well as the existing use of bio-based PLA as a filament and of conventional glass and carbon fibers for AM with conventional plastics, indicate an enormously fast-growing market for bio-based and plant-fiber-reinforced plastics.

#### 4.1 Matrix Materials

With an increasing market share, the production and life cycle of biodegradable bio-based plastics have been investigated for some time with regard to their environmental impact. PLA, which is already being additively processed, dominates as a plastic. The production routes from maize and sugar cane have been evaluated by Life Cycle Assessments (LCA) with regard to various environmental categories [14, 15]. The production of PLA from sugar cane with 2,334 gCO<sub>2</sub>/kg causes approx. 27% less GHG emissions than PET from fossil raw materials, which can also be additively processed, with 3,200 gCO<sub>2</sub>/kg. If the

bound CO<sub>2</sub> of 1,800 g/kg PLA is considered, the GHG emissions are approx. 84% lower. This contrasts with the significantly higher land use of 1,775 m<sup>2</sup> per ton of PLA. This land use can be considered for on the basis of the annual storage capacity of forests of 10 t CO<sub>2</sub>/ha by a missing annual CO<sub>2</sub> storage of 1,775 gCO<sub>2</sub>/kg PLA (see Fig. 2). For the disposal of biodegradable plastics, studies show that, similar to conventional plastics, mechanical recycling and incineration are preferable to composting or landfilling [16, 17]. Without accounting for land use, GHG emissions are lower for PLA than for PET in all three EOL scenarios: landfilling, power from WIP (Waste Incineration Plant) and heavy oil substitution in high temperature processes. When land use is considered, Fig. 2 shows that apart from mechanical recycling (not shown), only the addition of heavy oil substitutes in high-temperature processes is more climate-friendly than the landfilling of PET.

This is in contrast to the extremely low degradation rate of PET and the accumulation of microplastics in the environment during wild dumping. Considered for one year of product life cycle, the use of PLA instead of PET is always advantageous, except for the EOL scenario landfilling. Extrapolated to the annual global plastic consumption in glass fiber reinforced plastics of approx. 5 million tons, approx. 8,875 km<sup>2</sup> of arable land would be required in warm, humid regions. In return, 13.5 million tons of CO<sub>2</sub> could be saved, which corresponds to the annual binding by approx. 13,500 km<sup>2</sup> of forest and significantly overcompensates for land use.



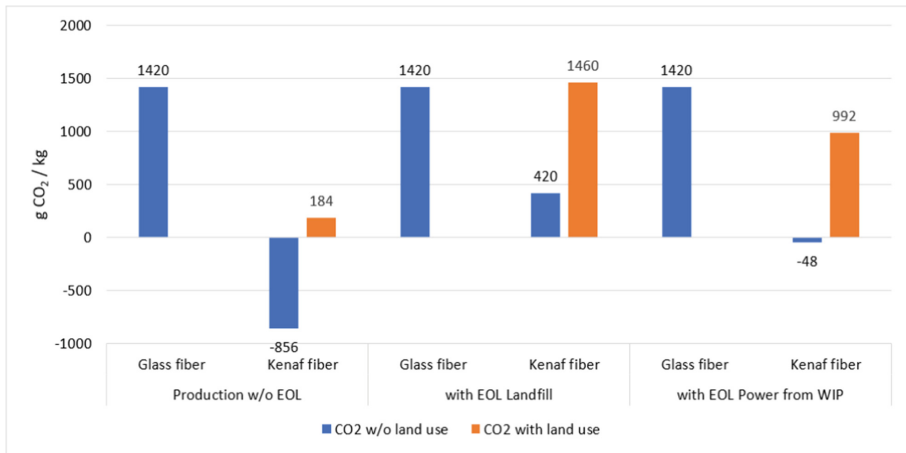
**Fig. 2.** Comparison of CO<sub>2</sub> emissions of PET and PLA without and with accounting for land use as missing CO<sub>2</sub> storage for 1 year.

## 4.2 Fiber Materials

Similar to bio-based plastics, studies on life cycle assessments have primarily shown savings in fossil energy and greenhouse gas emissions and comparatively higher land use [18–20]. The production of natural fiber using the example of kenaf consumes comparatively less than 10% of fossil energy and generates about 30% of greenhouse gas emissions without considering CO<sub>2</sub> storage [18]. This corresponds to the EOL scenario of landfilling, where the stored CO<sub>2</sub> is released (see Fig. 3). The land use of 1,040 m<sup>2</sup> of arable land per ton of kenaf can again be converted into a missing annual storage capacity



of 10 t/ha of forest [19]. As a result, the EOL scenario Landfill is slightly advantageous for fiber, while Power from WIP is only possible for kenaf and shows clear advantages. Again, extrapolated to the annual global glass fiber consumption in plastics of about 5 million tons, this would require about 5,200 km<sup>2</sup> of farmland. In return, 7.3 million tons of CO<sub>2</sub> would be saved in the EOL scenario Power from WIP, which corresponds to the annual binding by approx. 5,400 km<sup>2</sup> of forest.

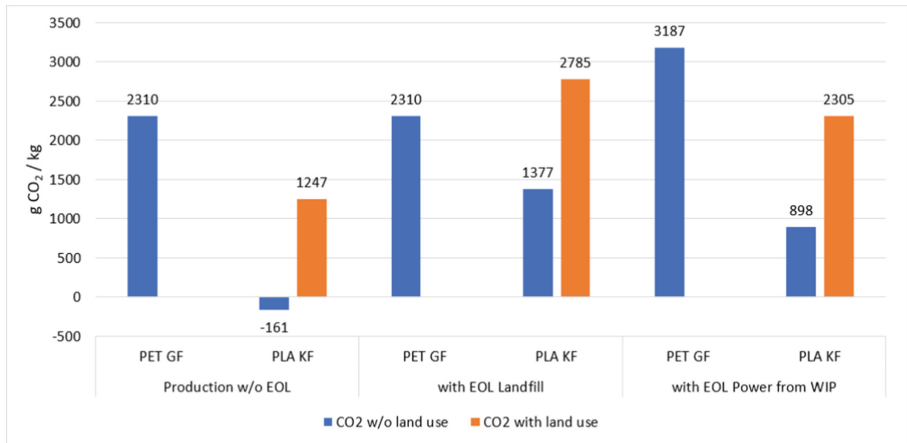


**Fig. 3.** Comparison of CO<sub>2</sub> emissions of glass fiber and kenaf fiber without and with accounting for land use as a missing CO<sub>2</sub> reservoir for 1 year.

### 4.3 Fiber-Reinforced Polymer Materials

The comparison of polymers and fiber materials with regard to greenhouse gas emissions without and with consideration of land use in the form of missing CO<sub>2</sub> storage capacity now leads to a comparison of glass fiber reinforced PET (PET GF) with PLA reinforced with kenaf fiber (PLA KF), which has 70–90% of the tensile strengths. Both composites are considered with a realistic 50% weight share of fiber material. Without taking land use into account, PLA KF causes about 60% of the greenhouse gas emissions of PET GF with the EOL scenario Landfill and about 30% with the EOL scenario Power from WIP (see Fig. 4). If land use in the form of lost forest storage capacity is included, PLA KF is significantly above PET GF with the EOL scenario Landfill, while the EOL scenario Power from WIP leads to 72% of the GHG emissions. The most climate-friendly EOL scenario here is also mechanical recycling, whereby fiber shortening during shredding leads to lower strength. The contribution of the use of natural fiber-reinforced degradable biopolymers to climate protection with the inclusion of land use is mainly determined by the EOL scenarios for a product lifetime of one year. If the product lifetime doubles, the influence of land use on the CO<sub>2</sub> balance is halved. Composting or landfilling lead to the release of the stored CO<sub>2</sub>, whereas with PET GF this lack of effect leads to a better balance. Nevertheless, the biodegradability of composites made of biopolymer and

natural fibers reduces the environmental impact of wild dumping. Microplastic emissions are estimated at 5–18 million tons of plastic worldwide [21]. The share of thermoplastic emissions for Germany is estimated at 38% in the same study. For conventional plastics, a degradation time of 2,000 years is assumed, which leads to the already visible and problematic accumulation in the environment.



**Fig. 4.** Comparison of the CO<sub>2</sub> emissions of PET GF and PLA KF without and with the inclusion of land use as a missing CO<sub>2</sub> reservoir for 1 year.

## 5 Conclusion

The present analysis shows that the use of composites based on bio-based and biodegradable materials is possible. Suitable matrix materials as well as reinforcing materials in the form of natural fibers are available for this purpose. The feasibility of these bio composites has already been extensively demonstrated. Additive manufacturing in the form of FFM is particularly suitable for implementation, as the insertion of fibers can be excellently integrated here. The economic and ecological analysis shows that the use of biomaterials makes a significant contribution to climate protection compared to conventional materials, if the products are used for a long time and recycled for materials or energy after use. However, these potentials are not yet being exploited on a large scale, as natural fibers are hardly available for additive manufacturing. In contrast to conventional composites, there is also a lack of suitable manufacturing systems that allow simple and safe processing of natural fibers in conjunction with bio-based matrix materials.

## References

1. Wohlers, T., Campbell, R.I., Diegel, O., Kowen, J., Mostow, N.: Wohlers report 2021. 3D printing and additive manufacturing: global state of the industry. Wohlers Associates, Fort Collins, Colorado (2021)

2. Gibson, I., Rosen, D., Stucker, B., Khorasani, M.: Additive Manufacturing Technologies. Springer eBook Collection, Cham (2021)
3. Domm, M.: Additive Fertigung kontinuierlich faserverstärkter Thermoplaste mittels 3D-Extrusion. IVW-Schriftenreihe, Band, no. 138 (2020)
4. Fidan, I., et al.: The trends and challenges of fiber reinforced additive manufacturing. *Int. J. Adv. Manuf. Technol.* **102**(5–8), 1801–1818 (2019). <https://doi.org/10.1007/s00170-018-03269-7>
5. Wambua, P., Ivens, J., Verpoest, I.: Natural fibers: can they replace glass in fiber reinforced plastics? *Compos. Sci. Technol.* (2003)
6. Mangat, A.S., Singh, S., Gupta, M., Sharma, R.: Experimental investigations on natural fiber embedded AM-based biodegradable structures for biomedical applications. *RPJ* **24**, 1221–1234 (2018)
7. Balla, V.K., Kate, K.H., Satyavolu, J., Singh, P., Tadimeti, J.G.D.: Additive manufacturing of natural fiber reinforced polymer composites: Processing and prospects. *Compos. Part B: Eng.* **174**, 106956 (2019)
8. Pandelidi, C., Bateman, S., Piegert, S., Hoehner, R., Kelbassa, I., Brandt, M.: The technology of continuous fiber-reinforced polymers: a review on extrusion additive manufacturing methods. *Int. J. Adv. Manuf. Technol.* **113**, 3057–3077 (2021). <https://doi.org/10.1007/s00170-021-06837-6>
9. Junk, S., Dorner, M., Fleig, C.: Additive manufacturing of continuous carbon fiber-reinforced plastic components. In: Scholz, S.G., Howlett, R.J., Setchi, R. (eds.) *Sustainable Design and Manufacturing 2020*. SIST, vol. 200, pp. 149–159. Springer, Singapore (2021). [https://doi.org/10.1007/978-981-15-8131-1\\_14](https://doi.org/10.1007/978-981-15-8131-1_14)
10. Witten, E., Mathes, V.: Der Markt für Glasfaserverstärkte Kunststoffe (GFK) 2020 (2022). [https://www.avk-tv.de/files/20201111\\_avk\\_marktbericht\\_2020.pdf](https://www.avk-tv.de/files/20201111_avk_marktbericht_2020.pdf). Accessed 11 April
11. Umweltbundesamt: Biobasierte und biologisch abbaubare Kunststoffe (2020). <https://www.umweltbundesamt.de/biobasierte-biologisch-abbaubare-kunststoffe#haufig-gestellte-fragen-faq>. Accessed 20 Dec 2021
12. SmarTech Publishing: New SmarTech Report: 3D Printed Composites Market Taking Off with Part Production Driving Global Revenues to Nearly \$10 Billion by 2028 (2017). <https://www.mcadcafe.com/nbc/articles/1/1637105/New-SmarTech-Report-3D-Printed-Composites-Market-Taking-Off-with-Part-Production-Driving-Global-Revenues-Nearly-10-Billion-by-2028>. Accessed 17 Dec 2021
13. Vink, E.T.H., Davies, S.: Life cycle inventory and impact assessment data for 2014 Ingeo™ Polylactide production. *Ind. Biotechnol.* **11**, 167–180 (2015)
14. Morão, A., de Bie, F.: Life cycle impact assessment of Polylactic Acid (PLA) produced from sugarcane in Thailand. *J. Polym. Environ.* **27**(11), 2523–2539 (2019). <https://doi.org/10.1007/s10924-019-01525-9>
15. Schulz, C.: Marktzahlen & Marktentwicklung biobasierter/bioabbaubarer Kunststoffe (2018). [https://www.ifbb-hannover.de/files/IfBB/downloads/webinarreihe/20180118\\_Webinar\\_16\\_Marktzahlen.pdf](https://www.ifbb-hannover.de/files/IfBB/downloads/webinarreihe/20180118_Webinar_16_Marktzahlen.pdf). Accessed 21 Dec 2021
16. Rossi, V., et al.: Life cycle assessment of end-of-life options for two biodegradable packaging materials: sound application of the European waste hierarchy. *J. Cleaner Prod.* **86**, 132–145 (2015)
17. Deng, Y.: Life Cycle Assessment of biobased fiber-reinforced polymer composites (2014)
18. Rezvani Ghomi, E., et al.: The life cycle assessment for Polylactic acid (PLA) to make it a low-carbon material. *Polymers* **13**, 1854 (2021)
19. De Beus, N., Carus, M., Barth, M.: Carbon Footprint and Sustainability of Different Natural Fibers for Biocomposites and Insulation Material (2019). <http://eiha.org/media/2019/03/19-03-13-Study-Natural-Fiber-Sustainability-Carbon-Footprint.pdf>. Accessed 11 April 2022

20. La Rosa, A., Grammatikos, S.: Comparative life cycle assessment of cotton and other natural fibers for textile applications. *Fibers* 7, 101 (2019)
21. Bertling, J., Hamann, L., Bertling, R. (Eds.): *Kunststoffe in der Umwelt. Kurzfassung der Konsortialstudie*, Fraunhofer-Institut für Umwelt-, Sicherheits- und Energietechnik (2018)

**Open Access** This chapter is licensed under the terms of the Creative Commons Attribution 4.0 International License (<http://creativecommons.org/licenses/by/4.0/>), which permits use, sharing, adaptation, distribution and reproduction in any medium or format, as long as you give appropriate credit to the original author(s) and the source, provide a link to the Creative Commons license and indicate if changes were made.

The images or other third party material in this chapter are included in the chapter's Creative Commons license, unless indicated otherwise in a credit line to the material. If material is not included in the chapter's Creative Commons license and your intended use is not permitted by statutory regulation or exceeds the permitted use, you will need to obtain permission directly from the copyright holder.





# Development of Magnetic Sheets for CO<sub>2</sub> Efficient Electric Drives Using an Additive Manufacturing Approach

Alexander Schmidt<sup>1,2</sup>(✉), Marco Ziegler<sup>2</sup>, Jörg Franke<sup>2</sup>, and Alexander Kuehl<sup>2</sup>

<sup>1</sup> Siemens AG, Otto-Hahn-Ring 6, 81739 Munich, Germany  
alexander-schmidt@siemens.com

<sup>2</sup> Institute for Factory Automation and Production Systems (FAPS),  
Friedrich-Alexander-Universität Erlangen-Nürnberg (FAU), Fuerther Strasse 246B,  
90429 Nuremberg, Germany

**Abstract.** Climate change and its negative consequences for the environment are the greatest challenge of the current era. Electric machines are considered key both for the generation of regenerative electricity and as a substitute for fossil fuels in industry and fossil engines in the transportation sector. Resource-efficient manufacturing and operation of electric machines are therefore of high importance. The central component of every electric machine is the soft magnetic core. The manufacturing process and material selection are influencing the iron losses during operation. This paper presents a novel technology for manufacturing magnetic sheets and lamination cores for carbon dioxide efficient electric drives using an additive manufacturing approach. The potential of the technology is explained and the challenges in process development are highlighted.

**Keywords:** Additive Manufacturing · Magnetic Sheets · Electrical Steel · Sustainable Manufacturing · Electric Motor · New materials

## 1 Introduction

The emission of greenhouse gases from fossil fuels are responsible for climate change. Therefore, different measures are necessary to reduce greenhouse gas emissions and slow down climate change with its negative consequences. The European Union (EU) agreed the European Green Deal in 2021. This intends a reduction in net greenhouse gas emissions of 55% in 2030 compared to 1990. By 2050, net greenhouse gas emissions are even to be reduced to zero. The transport and the industrial sector are major drivers of the emissions to be reduced, each accounting for 25% of the EU's total energy consumption. Therefore, electrification of these sectors with simultaneous supply of energy from renewable sources is indispensable for the success of the strategy [1, 2].

There are various electric machines such as electric drives for battery electric vehicles (BEV) or generators for wind turbines. In these, losses occur during energy conversion. This results in heating of the machine and the heat must be dissipated. Iron losses, which

can be reduced by using laminated FeSi electrical sheets, are a fundamental contributor to the total losses. Conventional electrical steel sheets are produced in complex multi-stage forming and heat treatment procedures and then processed into rotor or stator laminations [3]. The minimum thickness of the sheets to be processed is limited, as thinner sheets must be cold rolled more frequently. This increases brittleness until the magnetic sheet can no longer be further processed, e.g. punched. Standards for thin electrical sheets are classified between 0.2 and 1.0 mm according to DIN EN 10106 [4]. Also even thinner grades are under development. The application in electric machines is highly limited [5, 6]. Furthermore, material utilization during the forming of the stator and rotor sheets is about 50%, so that a large percentage of the unused material must be reprocessed expensively [7].

Due to the disadvantages of the conventional manufacturing process of electrical steel sheets for electric machines, new technologies and more efficient manufacturing processes need to be identified. This paper presents a concept for a novel additive manufacturing approach. In addition to flexibility and degree of freedom of the design, this approach enables a further reduction of the sheet thickness and thus of the eddy current losses. On the other hand, the material utilization in manufacturing phase can be maximized. First, a holistic process chain is established, starting with the iron powder, and ending with the stacked sheet package. Subsequently, the main potentials and challenges of this technology are shown and discussed.

## 2 State of the Art

In this part the different types of losses in electric machines are shown. Subsequently, the process chains for the conventional production of electrical steel and the process chain for the additive manufacturing of magnetic sheets are presented.

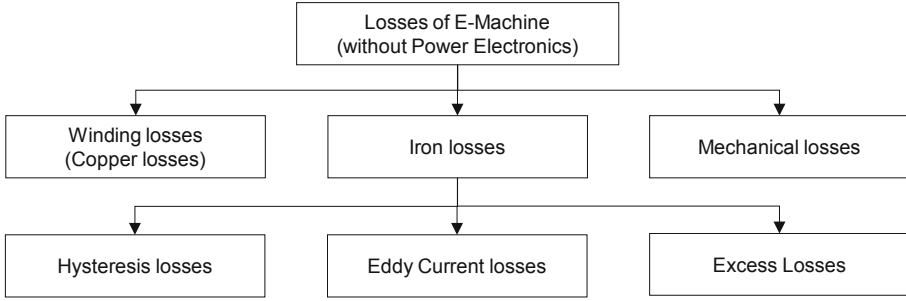
### 2.1 Losses in Electric Machines

The losses of electric machines vary within the torque-speed characteristic field. At constant torques, the ohmic losses in the windings of the stator determine the efficiency of the electric machine, since torque and current are proportional. In the medium speed range, the iron losses dominate, while the efficiency at high speeds is defined by the eddy current losses. In addition, mechanical losses such as friction occur during operation. Figure 1 classifies the loss components of electric machines [8].

The iron losses are divided into hysteresis, eddy current and excess losses [9]:

$$P_{Iron} = p_{hyst} + p_w + p_{exc} \quad (1)$$

The losses depend on the material density  $\rho$ . Hysteresis losses are the losses which arise due to wall movements in Weiss domains during the magnetization reversal process. This loss component is proportional to the area of the hysteresis loop traversed by the B-H diagram, characterized by maximum and minimum induction  $B$ . It is proportional to the frequency  $f$  of magnetic reversal and approximately proportional to the product



**Fig. 1.** Categorization of loss types in electric machines

of the axis intercept of the field strength, i.e. the coercivity  $H_c$  and the amplitude of the induction  $B_{max}$ :

$$p_{hyst} = k_H \times \frac{4H_c}{\rho} \times B_{max} \times f \quad (2)$$

The eddy current losses are calculated according to Maxwell's equations for the magnetic flux parallel to sheet direction with  $\sigma$  as electric conductivity and  $d$  as sheet thickness by:

$$p_w = \frac{\pi^2 \times \sigma \times d^2}{6\rho} B_{max}^2 \times f^2 \quad (3)$$

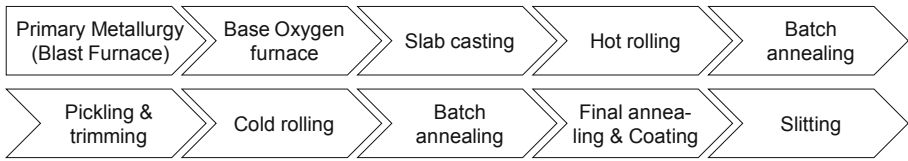
Since the loss contribution is reduced proportional to the square of the thickness  $d$ , any technology lowering the thickness fits to this task. In addition to global eddy current losses, local eddy current losses in the magnetic domain structure, known as excess losses, occur. These losses are attributed by Bertotti to the energy demand that arises during the displacement of the Bloch walls [9]:

$$p_{exc} = \frac{C_{exc}}{6\rho} B_{max}^{3/2} \times f^{3/2} \quad (4)$$

## 2.2 Conventional Manufacturing Process of Electrical Sheets

A distinction is made between grain-oriented (GO) electrical steel and not-grain-oriented (NO) electrical steel. GO electrical sheets have a preferred magnetic direction and therefore they are used in transformers, for example, because of the direction-dependent magnetization and the high importance of lowest hysteresis losses. Due to its isotropic properties, NO electrical sheets are more suitable for rotating machines such as electric drives as in these no magnetic preferred direction is desired [10].

NO electric steel is also distinguished between two manufacturing routes. One is semi-finished annealed electric steel. In this variant, the magnetic properties are finally adjusted after the sheet stacking process. In this way, manufacturing influences, for example by the stamping process, can be subsequently reduced. In this study, however, the fully finished NO electrical steel, which is frequently used in European industry and in the automotive sector, is considered. The manufacturing process for finally annealed NO electrical steel is summarized in Fig. 2, [10].

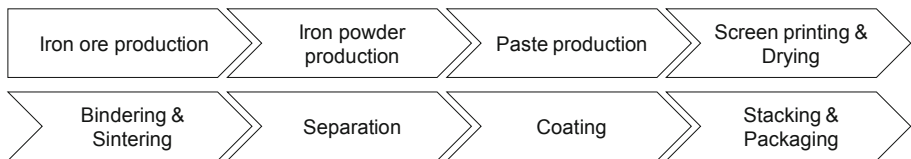


**Fig. 2.** Process chain for manufacturing of NO electrical steel coils for electric drives

### 2.3 Process Chain of Additive Manufactured Magnetic Sheets

The additive manufacturing approach to produce magnetic sheets is fundamentally different from conventional electrical steel production. There are various additive manufacturing processes to produce stators and rotors. These includes Selective Laser Melting (SLM) and Fused Deposition Modeling (FDM) as well as screen printing, which is selected in this case [11].

The starting point of the process chain is iron ore production, followed by iron powder production. Thus, it is not a strip material but a powder metallurgical process that is considered. To make the iron powder usable in screen printing, the paste rheology and in particular the viscosity of the paste must be adjusted with the aid of various solvents and binders. In addition, sintering additives are alloyed into the paste to allow optimum thermal processing of the magnetic sheet after printing. After sintering, the sheets are electrically insulated, stacked, and packaged. Figure 3 summarizes the process.



**Fig. 3.** Process chain for manufacturing of printed magnetic sheets for electric drives

In iron ore and iron powder production, there are no differences to standard powder metallurgical processes. Therefore, these steps will not be considered in more detail. The paste production for the screen printing includes the sub process steps weighing and mixing of its components. The paste is composed of iron powder, solvent, binder, and sinter additives. The ingredients are mixed until a homogeneous mass is obtained. Then the paste is applied to the screen-printing screen and printed on substrate carrier. Screen printing uses a squeegee to press printing paste through a fine-mesh texture onto a substrate. It is classified as a through-printing processes.

The green parts printed on the carrier are immediately dried to fix the geometry. In the next step, thermal processing is prepared. Therefore, a separation layer is applied to the magnetic sheets, and they are stacked. This intermediate step serves to better utilize of the furnace volume and is followed by debinding and sintering. In this thermal process the magnetic, mechanical and geometric properties are determined. After sintering, the stacks are separated, electrically insulated and then further processed into the final stack of sheets.



### 3 Potential Benefits and Challenges of Additive Manufactured Magnetic Sheets

This chapter highlights the various advantages and disadvantages of the additive manufacturing approach of magnetic sheets compared to the conventional rolling process. A distinction is made between technological, economic and sustainability aspects.

#### 3.1 Technology Evaluation

In the technological evaluation, simple and effective manufacturing processes on the one hand low iron losses and high magnetic permeability as well as high efficiency in the utilization phase of the electric machine are essentially. In this context the additive manufacturing of magnetic sheets offers various advantages. In the screen-printing process, the sheet thickness can be varied and reduced as required [12]. Lower sheet thicknesses reduce eddy current losses during operation of the electric machines. The higher the frequency in the application, the greater the effect of the sheet thickness on the total losses. Even the hysteresis losses can be positively influenced. During the printing and sintering process, tailored microstructures can be achieved, which are not possible in a cold rolling process. [10] In this way, the desired magnetization processes can be achieved, thus reducing the hysteresis losses.

In addition, Additive manufacturing enables the rapid design of complex but efficiency-optimized magnetic sheets, since no complex and expensive tools have to be constructed. For example, aimed control of the magnetic flux routing can be optimized by using local flux barriers [13].

For certain applications, there are further significant advantages. In the automotive sector, where installation space is severely limited, smaller machine dimensions are advantageous. But also in industrial robots, a reduction in the weight of the drive unit enables a wide range of opportunities. In combination, additively manufactured electric machines thus have the potential to achieve higher energy efficiency classes.

A technological challenge is to achieve a high sintering density of almost 100%. The more porous the material, the less iron, and thus magnetically conductive material, is in the laminated core.

A second technological challenge is the process step of insulating the magnetic sheets. While in conventional electric steel production the entire coil is insulated in the final annealing and coating process step, the individual sheet must be insulated in the additive manufacturing approach. This results in a significantly higher process complexity, due to the handling of individual sheets compared to rolled electrical steel.

#### 3.2 Economic Efficiency Analysis

The presented new technology is in the stage of pre-competitive development. The current costs are therefore not comparable with the standard process. Thus, ramp-up scenarios must be simulated. The profitability analysis evaluates the factors material costs and material utilization, manufacturing- and tooling costs as well as the Total Cost of Ownership (TCO) for the customer. Material costs are difficult to compare due to the

massive differences in quantities. With a small market share, the cost per ton for iron powder are higher than for electrical steel. In terms of material utilization, the additive manufacturing approach offers great potential since the final geometry is already printed in the green part state. Only solvents, binders and sintering additives are consumed from the material used. In the conventional production, the stator and rotor sheets are stamped out of the coil, resulting in a material loss of about 50%. Furthermore, the power consumption over the entire process chain can be reduced.

The conventional electrical steel production is an established and cost-optimized process. Manufacturing costs per ton vary depending on technical data, such as alloy composition and sheet thickness. Printed sheets can achieve similar costs for high-end-products. For industrial standard applications, the manufacturing costs are higher.

Due to the higher efficiency (Chapter 3.1), the utilization phase is the determining factor for the economic efficiency of printed magnetic sheets. The higher the amount of operating hours of the electric machine and the more complex the operating scenarios in terms of acceleration and speed variance, the more advantageous the TCO. Higher manufacturing costs can be compensated by energy savings and material savings at the system level. For example, through a lower demand for copper for the winding or permanent magnets.

The economic analysis estimates that the conventional manufacturing is economically advantageous in the production phase for standardized and high-volume products. The innovative manufacturing approach is particularly suitable for high-performance machines and complex operating models, where the technological benefits are more pronounced.

### 3.3 Sustainability Analysis

The analysis of sustainability is based on the technological and cost potential presented. As before, a distinction is made between the manufacturing phase and the use phase. Printed magnetic sheets improve the environmental footprint of electric machines compared to the conventionally manufactured sheets. The material utilization rate is significantly higher, as no stamping waste is produced. This currently must be transported again and reprocessed with high effort.

Printed magnetic sheets are also advantageous in the utilization phase of the electric drives, as they are more efficient due to the reduced sheet thickness as well as isotropy and high purity. This leads to lower energy consumption for the same output. For the utilization phase, the electricity mix of the country in which the motor is used must be taken to account. The lower the proportion of green electricity, the higher the positive effect of energy savings on the CO<sub>2</sub> footprint [14].

### 3.4 Assessment of Technological, Economic and Sustainability Potentials

Finally, the potentials of the technologies are summarized and compared in Table 1. The evaluation at this stage takes the form of higher versus lower potential.

**Table 1.** Assessment of technological, economic and sustainability potentials

	Conventional manufacturing of magnetic sheets	Additive manufacturing of magnetic sheets
Technology		
Motor efficiency	0	+
Magnetic properties	0	+
Stacking factor (Iron)	+	0
Economic		
Material costs	+	0
Manufacturing costs	+	0
Energy costs	0	+
Sustainability		
Resource efficiency (material utilization rate)	0	+ +
Energy efficiency	0	+

## 4 Conclusion and Outlook

Printing magnetic sheets for use in electric machines offers technological advantages, as the reduction in the thickness of the laminations can significantly reduce eddy current losses during operation. In addition, resource efficiency in manufacturing and operation phase of different types of electrical machines such as spindle-, traction- or robot drives can be increased. The current development and scaling of the technology is based on parameter studies, which are evaluated using Six Sigma methods such as design of experiment to increase process repeatability and reproducibility. This is necessary to reach out the economic goals.

As part of a public funded project, the sub-process steps for producing the powder based magnetic sheets are first to be developed and scaled up. In the second step, the parts will be combined into a holistic, continuous and traceable overall process. In parallel, methods and use cases will be developed to qualitatively compare the technological and ecological benefits with the conventional manufacturing of electrical steel.

**Acknowledgement.** This work is supported by the German Federal Ministry of Economic Affairs and Climate Action (BMWK) within the funding program Application-oriented non-nuclear R&D in the 7<sup>th</sup> Energy Research Program under the contract number 03EN4013 (EffiBlech). The authors would like to thank all participating colleagues at Siemens Technology namely Gotthard Rieger and Thomas Soller for consulting and reviewing the publication.

## References

1. European-Union. <https://eur-lex.europa.eu/legal-content/EN/TXT/HTML/?uri=CELEX:52019DC0640&from=DE>. Accessed 12 Apr 2022
2. European Environment Agency. <https://www.eea.europa.eu/de/themes/transport/intro>. Accessed 12 Apr 2022
3. Schoppa, A.: Einfluss der Be- und Verarbeitung auf die magnetischen Eigenschaften von schlussgeglühtem, nicht kornorientiertem Elektrobund. RWTH Aachen, DE (2001)
4. DIN, E.V.: EN 10106. Kaltgewalztes nicht kornorientiertes Elektrobund und -blech im schlussgeglühten Zustand, Berlin (2015)
5. DIN, E.V.: EN 10303:2016 DE. Dünnes Elektrobund und -Blech aus Stahl zur Verwendung bei mittleren Frequenzen, Berlin 2016
6. C.D. Wälzholz GmbH & Co. KG. <https://www.waelzholz.com/stahlwerkstoffe/elektrobund/no-gueten.html>. Accessed 13 May 2022
7. Libert, F., Soulard, J.: Manufacturing methods of stator cores with concentrated windings. In Proceedings of the 2006 3rd IET International Conference on Power Electronics, Machines and Drives—PEMD, Dublin, Ireland, 4–6 April 2006
8. Lamprecht, E., Homme, M., Albrecht, T.: Investigation of eddy current losses in laminated cores due to the impact of various stacking processes. In: EDPC 2nd International Electric Drives Production Conference, Nuernberg, DE (2012). <https://doi.org/10.1109/EDPC.2012.6425097>
9. Bertotti, G.: Hysteresis in Magnetism: for Physicists, Materials Scientists, and Engineers, Ser. Academic Press Series in Electromagnetism, San Diego (1998). ISBN: 978-0-12-093270-2
10. Boll, R.: Weichmagnetische Werkstoffe – Einführung in den Magnetismus VAC-Werkstoffe und ihre Anwendungen. 4th edn. Vacuumschmelze GmbH, Hanau, DE (1990)
11. Bernier, F., et al.: Additive manufacturing of soft and hard magnetic materials used in electrical machines. *Met. Powder Rep.* **75**(6), 334–343 (2020)
12. Lorenz, A., et al.: Screen printed thick film metallization of silicon solar cells – recent developments and future perspectives. In: 35th European Photovoltaic Solar Energy Conference and Exhibition, pp. 819–824 (2018) <https://doi.org/10.4229/35thEUPVSEC20182018-2DV.3.65>
13. Schauerte, B., et al.: The influence of residual stress on flux-barriers of non-oriented electrical steel. *J. Magn. Magn. Mater.* **504** (2020)
14. Mouhamad, M., Lauzevis, P.: Life cycle assessment and inrush currents measurement of amorphous transformers. In: 22nd International Conference on Electricity Distribution, Stockholm (2013)

**Open Access** This chapter is licensed under the terms of the Creative Commons Attribution 4.0 International License (<http://creativecommons.org/licenses/by/4.0/>), which permits use, sharing, adaptation, distribution and reproduction in any medium or format, as long as you give appropriate credit to the original author(s) and the source, provide a link to the Creative Commons license and indicate if changes were made.

The images or other third party material in this chapter are included in the chapter's Creative Commons license, unless indicated otherwise in a credit line to the material. If material is not included in the chapter's Creative Commons license and your intended use is not permitted by statutory regulation or exceeds the permitted use, you will need to obtain permission directly from the copyright holder.





# Towards a Comparative Index Assessing Mechanical Performance, Material Consumption and Energy Requirements for Additive Manufactured Parts

Leopoldo De Bernardes<sup>1</sup>, Giampaolo Campana<sup>2</sup>(✉), Mattia Mele<sup>2</sup>,  
and Sebastian Mur<sup>1</sup>

<sup>1</sup> Instituto Tecnológico de Buenos Aires (ITBA), Iguazú 341, C1437 Buenos Aires,  
Ciudad Autónoma de, Argentina

<sup>2</sup> Department of Industrial Engineering, University of Bologna, Viale Risorgimento 2,  
40136 Bologna, Italy

giampaolo.campana@unibo.it

**Abstract.** The increasing use of Additive Manufacturing technologies and systems in several industrial sectors and their numerous applications turn the attention of scientists and investigators to studying and evaluating the environmental impacts of these processes. Additive Manufacturing generally allows for a reduction of raw material consumption and waste generation. On the other hand, the need for long processing times and the necessary thermal conditioning of the manufacturing chamber to avoid product defects, lead to a considerable amount of consumed energy per produced item. Energy consumption has been a primary concern of the research on the sustainability of Additive Manufacturing indeed. More recent studies extended the analysis through more complete evaluation methods such as the Life Cycle Assessment. This approach allows a detailed description of environmental impacts but is affected by some concerns about the need for an interpretation of the final results, which can be non-univocal. This fact is particularly critical when the assessment is intended to be used for comparison between alternative solutions.

In this study, a novel index is introduced including three main aspects: material consumption, energy requirements and mechanical performance. The proposed formulation makes the index immediately usable for comparing alternative solutions. Within the scope of this study, the index has been applied to one of the most widespread Additive Manufacturing processes, namely Fused Filament Fabrication. The presented case study demonstrates the suitability of the proposed method to compare and identify the optimal choice among alternative manufacturing scenarios.

**Keywords:** Additive Manufacturing · Fused Filament Fabrication · Energy Consumption · Life Cycle Assessment · Performance Index

## 1 Introduction

Additive Manufacturing (AM), also known as 3D printing (3DP), is becoming increasingly important in modern industry. Although prototyping is still today one of the most widespread uses of AM, several applications for the production of end-use parts can be found in the industry. The role of these processes is expected to become even more crucial to the manufacturing of the future under the impulse of the Industry 4.0 paradigm [1]. Analysts forecast an expansion of the AM market with a Compound Annual Growth Rate of 21% from 2021 to 2028 [2]. This scenario makes the research on AM sustainability especially relevant. Specifically, it is necessary to provide users with adequate tools to predict and reduce the environmental impacts of these technologies.

Most of the research focused on the electrical performances of the process. This is because 3DP is generally characterized by long processing times, which determine a higher machine utilization and energy consumption if compared to traditional technologies [3]. Conversely, AM has generated an important expectation for material saving since it allows for designing lightweight parts and reducing waste [4].

Life Cycle Assessment (LCA) has been extensively adopted to quantify the Environmental Impacts (EIs) of 3DP processes. The most common application of these studies is to compare the impacts of AM with those of traditional processes [5].

LCA methods comprise indicators describing different aspects of the impact on the environment the results of the study consist of multiple indicators which cannot be directly aggregated. This poses serious issues when LCA is used for comparison purposes. Moreover, this method does not consider the effects of manufacturing strategies on part properties. This is the main limitation since in real industrial cases it is very important to know in advance the impact that the manufacture of a new product will have on obtaining the desired mechanical properties, seeking an intelligent solution that allows the use of materials and energy to be limited.

Several indicators inspired by the triple bottom line framework and related to environmental, economic and social performance were proposed. A literary review concerning sustainable performance indicators is presented in [6]. Nearly seventy indicators were considered with the aim to identify a strategy for selecting those indicators that are principle contributors to sustainability and to validate the proposed selection through a comparison to ten of the most widely used indicator sets and guidelines. All the considered indices do not take into account the mechanical properties of materials and manufactured parts.

A novel index named Consumption Performance Sustainability Index (CPSI) is presented here for the comparison of manufacturing solutions. This index is calculated through a very simple formulation including the most relevant aspects to process sustainability, namely energy and material consumption. In addition, the mechanical properties are included to provide the designer with information on the expected resistance of the manufactured part. Two different formulations of the index accounting for different mechanical properties are presented and compared in the following sections.

The CPSI is dimensionless so that different designs, materials and production processes can be compared more easily and it is not necessary to express it in particular units such as tons of equivalent CO<sub>2</sub> produced.

A direct comparison with other known indicators is outside the scope of the present work.

The proposed index is presented with an application to Fused Filament Fabrication (FFF), which is the most widespread AM process on the market. There is a large body of research on this process discussing the impact of this technology and the influence of process parameters on mechanical properties [7]. A complete review of this literature is beyond the scope of this study.

Tensile specimens with different infill orientations and densities have been manufactured through an industrial-grade FFF printer. In-line measurement of energy consumption was carried out during printing. Tensile tests allowed for measuring the mechanical properties of each infill strategy. The information collected was then used to calculate the index and compare the different solutions.

## 2 Methods

### 2.1 Consumption Performance Sustainability Index

In the general formulation, the CPSI can be expressed as in Eq. 1:

$$CPSI = I_{mat} \times I_{en} \times I_{pp} \times I_{mp} \times I_{\rho} \quad (1)$$

where  $I_{mat}$  accounts for material consumption,  $I_{en}$  accounts for energy consumption,  $I_{an}$  accounts for part performance,  $I_{mp}$  accounts for material performance and  $I_{\rho}$  accounts for part density.

The material consumption index is defined in Eq. 2:

$$I_{mat} = \frac{m_{part}}{m_{tot}} \quad (2)$$

where  $m_{part}$  and  $m_{tot}$  are the mass of the part and the total consumed material, respectively. The difference between these two quantities is determined by the auxiliary material needed for printing. For example, several AM processes require support structures to print overhang geometries [8]. The amount of these support structures is strongly affected by the design and build orientation of the part.

As it can be seen in Eq. 2,  $I_{mat}$  is dimensionless. High values of this index mean a low amount of waste during the process, i.e. an efficient use of resources.

The energy consumption index is defined in Eq. 3:

$$I_{en} = \frac{m_{tot}}{E_p} \quad (3)$$

where  $E_p$  is the energy consumed for printing. This quantity can vary significantly depending on the AM process considered. Moreover, process parameters can drastically affect energy consumption [9].

$I_{en}$  can also be seen as the inverse of the specific energy, i.e. the energy consumption per mass unit. Therefore, for a certain amount of processed material, higher values of  $I_{en}$  correspond to lower energy consumption. If using the International System of Units

(SI), the unit of measure of this index is  $s^2/m^2$ . Although this ratio is not dimensionless, its units will be offset by those of the material performance index.

The part performance index is calculated as in Eq. 4:

$$I_{pp} = \frac{P_{part}}{P_{mat}} \quad (4)$$

where  $P_{mat}$  and  $P_{part}$  are the mechanical property of the material and the 3D printed part, respectively, along the direction of the applied load. “P” can be Young’s modulus or the Ultimate Tensile Strength (UTS) depending on which of these requirements is more relevant to the design. This index is strongly affected by the printing strategy and process parameters. Particularly, build orientation and hatching strategies can determine considerable differences between the mechanical properties of the base material and those of the manufactured parts.

The formulation of the material performance index  $I_{mp}$  is shown in Eq. 5:

$$I_{mp} = \frac{P_{mat}}{\rho_{mat}} \quad (5)$$

where  $\rho_{mat}$  is the density of the feedstock material. It can be seen that substituting Young’s modulus and UTS in Eq. 5 leads to, respectively, the specific modulus and specific strength of the material [10]. These properties give important information on the material resistance with reference to its weight. This is important not only to reduce the amount of waste at the end of the product’s life but also for applications where lightweight parts can reduce the impacts of use [11, 12]. Both calculated based on Young’s modulus or UTS, the units of the material performance index are  $m^2/s^2$  in the SI and compensate for those of the energy consumption index as stated previously.

The part density index is defined in Eq. 6:

$$I_{\rho} = \frac{\rho_{mat}}{\rho_{part}} \quad (6)$$

where  $\rho_{part}$  is the density of the manufactured part, i.e. the ratio between the part mass  $m_{part}$  and  $V_{model}$  the volume of the virtual model.  $I_{\rho}$  can be expressed in Eq. 7:

$$I_{\rho} = \frac{V_{model}}{m_{part}} \rho_{mat} \quad (7)$$

A difference between  $\rho_{mat}$  and  $\rho_{part}$  may be due to the non-complete filling of the part, which may be intentional, in case of hatching densities lower than 100%, or due to porosities induced by the manufacturing process [13]. This index is dimensionless.

The final formulation of the CPSI can be obtained by substituting Eqs. 2 to 7 in Eq. 1. The final formulation differs based on whether Young’s modulus or UTS are considered for design; the corresponding indices  $CPSI_Y$  and  $CPSI_{\sigma}$  are given, respectively, in Eq. 8 and Eq. 9:

$$CPSI_Y = \frac{m_{part}}{m_{tot}} \times \frac{m_{tot}}{E_p} \times \frac{Y_{part}}{Y_{mat}} \times \frac{Y_{mat}}{\rho_{mat}} \times \frac{V_{model}}{m_{part}} \rho_{mat} = \frac{Y_{part}}{e_p} \quad (8)$$



$$CPSI_{\sigma} = \frac{m_{part}}{m_{tot}} \times \frac{m_{tot}}{E_p} \times \frac{UTS_{part}}{UTS_{mat}} \times \frac{UTS_{mat}}{\rho_{mat}} \times \frac{V_{model}}{m_{part}} \rho_{mat} = \frac{UTS_{part}}{e_p} \quad (9)$$

where  $e_p = E_p/V_{model}$  is the consumed energy per unit of volume of the model.

As it can be noticed, the formulation in Eqs. 8 and 9 allows for the calculation of the CPSI with a limited amount of information. This is a key point to facilitate the adoption of the index for decision-making in real industrial cases, enhancing the sustainability of the results.

## 2.2 Experimental Methods

The CPSI was applied to parts manufactured by FFF for validation. Specifically, a set of tensile specimens designed as in ASTM D638–14 type I standard was used for the characterization of mechanical properties.  $V_{model}$  is then equal to  $22067 \text{ mm}^3$ . The specimens were manufactured with different combinations of infill density and orientation. Specifically, a full-factorial Design of Experiment (DOE) was carried out using three levels of infill density (namely 100%, 90% and 80%) and three directions of hatching lines, i.e.  $0^\circ$ ,  $90^\circ$  and  $\pm 45^\circ$  to the load direction. Three repetitions of each specimen were tested. All the specimens were printed with a Fortus 250 by Stratasys® using ABS SR30 for parts and ABS P430 for support structures. A T14 nozzle with a 0.356 mm diameter was used for the process. The energy consumed by the printer was acquired through an EInet Energy and Powermeter with serial and TPC/IP interface ports allowing direct interface with a PC. The specimens were tested with a universal testing machine Instron 3382 equipped with a long travel 2603–080 extensometer.

## 3 Results and Discussions

### 3.1 Experimental Results

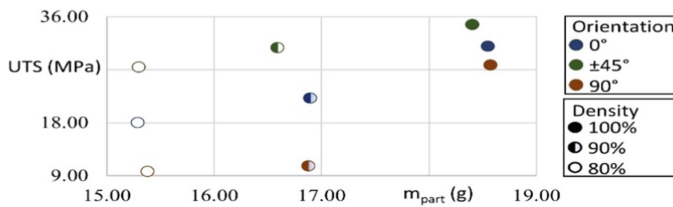
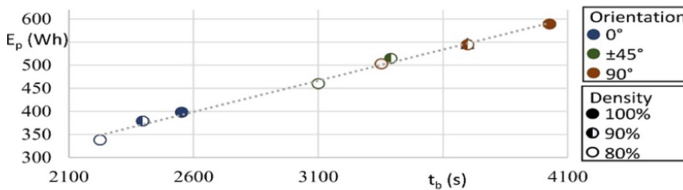
Table 1 reports the measured data of the manufactured specimens, where  $t_b$  is the building time and the other variables are as previously defined.

In Fig. 1 UTS values versus part mass are shown. It can be seen that the highest strength is observed in specimens oriented at  $0^\circ$ , i.e. when the material is deposited along the load direction, being in good agreement with existing studies on the anisotropy of FFF parts. It can also be observed in Fig. 1 that the UTS of parts linearly decreases with density in the case of  $0^\circ$  orientation, while a drastic reduction is observed moving from 100% to 90% in the case of  $90^\circ$  due to that when tracks are not adjacent, the filament is not able to transmit the stress along the direction of the load. On the other hand, the printing time varies significantly with the infill strategy, as can be observed in Table 1. Specifically, the specimens oriented at  $0^\circ$  require less time than others due to the lower number of direction changes required by this path. Remarkably, the energy consumption is almost linearly proportional to the building time, as can be seen in Fig. 2, suggesting that the main source of energy consumption is the heating system.

In fact, during printing, the build chamber is maintained at  $76^\circ \text{C}$  to ensure the quality of manufactured parts. Therefore, the energy required to maintain these temperatures appears to be the main contribution to the overall energy consumption of this technology. This result is consistent with the findings of previous studies [14].

**Table 1.** Measured data

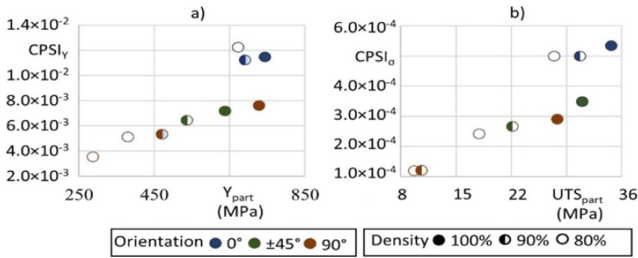
Density (%)	Orientation (°)	$E_p$ (Wh)	$m_{part}$ (g)	$t_b$ (s)	UTS <sub>part</sub> (MPa)	$Y_{part}$ (MPa)
100	0	$398 \pm 17.8$	$18.4 \pm 0.1$	$2552.7 \pm 0.6$	$34.7 \pm 0.6$	$743.7 \pm 45.5$
90	0	$378.7 \pm 6$	$16.6 \pm 0.1$	$2396.7 \pm 0.6$	$30.8 \pm 0.4$	$692.1 \pm 31.7$
80	0	$338 \pm 19.1$	$15.3 \pm 0.1$	$2225.7 \pm 0.6$	$27.5 \pm 0.5$	$673.7 \pm 35.8$
100	90	$589 \pm 21.8$	$18.6 \pm 0$	$4027.3 \pm 34.9$	$27.8 \pm 1.1$	$728 \pm 48$
90	90	$544.3 \pm 7.2$	$16.9 \pm 0.2$	$3699 \pm 1$	$10.6 \pm 1$	$471.3 \pm 30$
80	90	$503 \pm 11.8$	$15.4 \pm 0$	$3353.3 \pm 0.6$	$9.7 \pm 0.3$	$287.9 \pm 8.5$
100	$\pm 45$	$546.7 \pm 9.3$	$18.5 \pm 0.1$	$3697.7 \pm 0.6$	$31 \pm 0.9$	$638.1 \pm 28.2$
90	$\pm 45$	$514.3 \pm 2.1$	$16.9 \pm 0.1$	$3391.3 \pm 0.6$	$22.2 \pm 1$	$538 \pm 14.1$
80	$\pm 45$	$459.7 \pm 22$	$15.3 \pm 0.1$	$3101 \pm 0$	$18 \pm 0.5$	$381.1 \pm 10.3$

**Fig. 1.** Ultimate tensile strength versus part mass**Fig. 2.** Energy consumption versus printing time of parts

### 3.2 Consumption Performance Sustainability Index Calculation

The  $CPSI_Y$  and  $CPSI_\sigma$  indices of different specimens are plotted in Fig. 3a and Fig. 3b, respectively. Notice the difference between the  $CPSI$  values calculated using Young Modulus and UTS. Figure 3 shows that the solution with infill oriented at  $0^\circ$  appears to be preferable in both analyses. This is consistent with the results of Table 1, which show that this orientation allows for minimising building time and energy consumption while maximizing mechanical performance. Interestingly, the highest value of  $CPSI$  corresponds to different solutions whether Young's modulus or UTS are considered. Specifically, the solution with 80% infill density and  $0^\circ$  orientation is preferred in the case of Young's modulus. This finding suggests that, as far as this orientation is concerned, the improvement in stiffness achievable by maximising the infill density is less relevant than the impact on energy consumption. The solution at 100% is still slightly preferable

to that at 90%. On the other hand, the maximum CPSI  $\sigma$  is achieved at 100% density and 0° orientation. In other words, the increase in strength justifies a higher energy consumption.



**Fig. 3.** Consumption performance sustainability obtained considering a) Young’s modulus and b) Ultimate tensile strength

When considering other orientations, it is possible to notice that solutions at higher densities appear to be always preferable. This can be explained if considering the sharp drop in mechanical properties reported in Table 1. On the other hand, CPSI<sub>y</sub> is higher for full specimens oriented at 90° than for those at ± 45°. This is consistent with the higher stiffness of these specimens. An opposite ranking is observed for CPSI<sub>σ</sub>. This index drops for specimens oriented at 90° with infill densities lower than 100%, which exhibit poor mechanical properties in the face of high energy consumption.

### 4 Conclusions

This paper presented a novel index named CPSI to compare different solutions in AM processes. This index aims at combining the environmental impacts of the process and mechanical properties of the manufactured parts. CPSI is dimensionless in order to allow for the comparison of different solutions.

The index has been obtained by multiplying coefficients accounting for different properties of the material, geometry and process. The formulation of the index allows for the simplification of numerous terms, which leads to a simplified formula. This means that the CPSI can be calculated with a limited amount of data, which eases the adoption to drive decision-making in real industrial cases.

The effectiveness of the index has been verified in a real 3D printing process. Specifically, a set of specimens for tensile tests has been printed on an industrial-grade FFF machine acquiring the energy consumption during the process. The results demonstrated that the index allows for the identification of the solution with the best compromise between mechanical performance and resource consumption. It has been shown that the preferable solution changes depending on which mechanical property is considered during design. This is due to the high influence of deposition strategies on the performance of manufactured parts in this process.

Overall, the index appears to be an easy-to-use and effective way to compare different manufacturing scenarios or part designs. Therefore, the adoption of this index is expected

to foster the reduction of impacts in AM applications. In addition, we are planning further activities to extend the use of the proposed index to other manufacturing processes with particular attention to other AM processes.

## References

1. Ali, M.H., Batai, S., Sarbassov, D.: 3D printing: a critical review of current development and future prospects. *Rapid Prototyp. J.* **25**, 1108–1126 (2019)
2. Grand View Research: 3D Printing Market Size, Share & Trends Analysis Report By Component, By Printer Type (Desktop, Industrial), By Technology, By Software, By Application, By Vertical, By Material, By Region, And Segment Forecasts, 2021–2028 (2021)
3. Bourhis, F.L., Kerbrat, O., Hascoet, J.-Y., Mognol, P.: Sustainable manufacturing: evaluation and modeling of environmental impacts in additive manufacturing. *Int. J. Adv. Manuf. Technol.* **69**(9–12), 1927–1939 (2013). <https://doi.org/10.1007/s00170-013-5151-2>
4. Huang, S.H., Liu, P., Mokasdar, A., Hou, L.: Additive manufacturing and its societal impact: A literature review. *Int. J. Adv. Manuf. Technol.* **67**, 1191–1203 (2013)
5. Saade, M.R.M., Yahia, A., Amor, B.: How has LCA been applied to 3D printing? A systematic literature review and recommendations for future studies. *J. Clean. Prod.* **244**, 118803 (2020)
6. Taddese, G., Durieux, S.: DucSustainability performance indicators for additive manufacturing: a literature review based on product life cycle studies. *Int. J. Adv. Manuf. Technol.* **107**, 3109–3134 (2020)
7. Braconnier, D.J., Jensen, R.E., Peterson, A.M.: Processing parameter correlations in material extrusion additive manufacturing. *Addit. Manuf.* **31**, 100924 (2020)
8. Gan, M.X., Wong, C.H.: Practical support structures for selective laser melting. *J. Mater. Process. Technol.* **238**, 474–484 (2016)
9. Liu, Z., et al.: Investigation of energy requirements and environmental performance for additive manufacturing processes. *Sustain.* **10**, 3606 (2019)
10. Gooch J. W.: Specific strength. In: Gooch J. W. (ed.) *Encyclopedic Dictionary of Polymers*, p. 685 Springer, New York (2011)
11. Huang, R., et al.: Energy and emissions saving potential of additive manufacturing: the case of lightweight aircraft components. *J. Clean. Prod.* **135**, 1559–1570 (2016)
12. Böckin, D., Tillman, A.M.: Environmental assessment of additive manufacturing in the automotive industry. *J. Clean. Prod.* **226**, 977–987 (2019)
13. Ellis, A., Noble, C.J., Hopkinson, N.: High Speed Sintering: Assessing the influence of print density on microstructure and mechanical properties of nylon parts. *Addit Manuf* **1**, 48–51 (2014)
14. Faludi, J., Bayley, C., Bhogal, S., Iribarne, M.: Comparing environmental impacts of additive manufacturing vs traditional machining via life-cycle assessment. *Rapid. Prototyp. J.* **21**, 14–33 (2015)



**Open Access** This chapter is licensed under the terms of the Creative Commons Attribution 4.0 International License (<http://creativecommons.org/licenses/by/4.0/>), which permits use, sharing, adaptation, distribution and reproduction in any medium or format, as long as you give appropriate credit to the original author(s) and the source, provide a link to the Creative Commons license and indicate if changes were made.

The images or other third party material in this chapter are included in the chapter's Creative Commons license, unless indicated otherwise in a credit line to the material. If material is not included in the chapter's Creative Commons license and your intended use is not permitted by statutory regulation or exceeds the permitted use, you will need to obtain permission directly from the copyright holder.





# A Framework to Compute Carbon Emissions Generated from Additive Manufacturing Processes

Vasiliki C. Panagiotopoulou , Aikaterini Paraskevopoulou,  
and Panagiotis Stavropoulos  

Laboratory for Manufacturing Systems and Automation, University of Patras, 26504 Patras,  
Greece

pstavvr@lms.mech.upatras.gr

**Abstract.** Additive Manufacturing (AM) is an emerging and promising technology increasingly adopted from Industry. However, Industry is responsible for the majority of global carbon emissions (CEs), heavily contributing to greenhouse effect. Therefore, it is important to define the environmental impact of all processes, including AM carbon footprint. This work aims at reviewing literature for the equations for CE calculations of AM and developing a framework for CEs calculations generated from all the types of AM. Literature was found for some AM types, with each type of AM described stepwise and categorized per Process, Machine and System level. At each step, the equations for CEs, based on carbon emission factor and energy spent, were allocated. At process level, CEs come exclusively from the energy spent for curing. At the machine level, CEs are related to the process, auxiliary equipment and consumables. At system level, additional CEs are derived from material used, pre-processing and post-processing steps. Total carbon emissions are the sum of CEs at machine level and additional CEs from system level. Generalization of this approach led to a framework that can be used for all types of AM, to calculate CEs of each AM type based on the steps included.

**Keywords:** Additive Manufacturing · Carbon Emission Calculation · Carbon Footprint

## 1 Introduction

Additive Manufacturing (AM) is the process of joining materials to make objects from 3D model data, usually layer upon layer [1] and it is one of the fundamental elements of the fourth industrial revolution [2–4]. However, industrial advantages often come with increased carbon emissions (CE), leading to increase of global temperature. This is why the term of carbon footprint has been developed, in order to measure the environmental impact of products, processes, infrastructures, individuals, mainly all human related activities. Carbon footprint is the total amount of greenhouse gases, including dioxide and methane, that are generated by our actions [5]. As the role of ecological constraints

is increasing affect manufacturing technologies [6], it is imperative that AM is examined from an environmental point of view.

Previous literature presents the environmental impact of AM [7–9] and how to reduce it [10]. Optimization models have also been suggested regarding the energy efficiency of AM [11], while others try to approach it from a sustainability point of view [12, 13]. However, a holistic analysis regarding the carbon footprint of every AM method is yet to be done.

The aim of this study is to develop a framework for computing carbon emissions generated from additive manufacturing processes using appropriate energy equations.

## 2 Materials and Methods

This study focuses on summarizing the methodologies used for calculating the CE of AM processes, on the type and the amount of energy that these processes require, as well as the necessary materials. Databases of Google Scholar, ResearchGate and ScienceDirect were researched for relevant papers. Keywords used were: “additive manufacturing”, “CO<sub>2</sub> emission”, “environmental impact”, “carbon emission”. In order to be considered for the review, the papers had to fulfill the following selection criteria: (a) Type of process and (b) Calculation of CE using mathematical equations. At the end, the papers were categorized as follows:

- Stereolithography (SLA)
- Selective Laser Sintering (SLS)
- Electron Beam Melting (BEM)
- Laser Engineered Net Shaping (LENS)
- Fused Deposition Modeling (FDM)

Each AM approach has multiple steps, starting from auxiliary equipment switching on, all the way to the equipment being shut down when operations are over. For this, the three-level approach was used as proposed by *Fysikopoulos et al.* (2014) [14] in the case of machining, where steps were grouped per process, machine tool and system level. Process concerns the energy interactions related to the physical mechanisms of the process itself”. The machine level focuses on the auxiliary equipment and the consumables (fluids etc.). System is about the material consumption and the actions that take place before or after the processing.

## 3 Results

Literature review was done to figure out how much work was already done regarding the carbon footprint calculation of AM processes. Precisely, Stereolithography (SLA) [15], Selective Laser Sintering (SLS) [16], Electron Beam Melting (EBM) [17], Laser Engineering Net Shaping (LENS) and Fused Deposition Modeling [18], each had one paper estimating, however, their energy consumption instead of the carbon footprint. Then the CE was calculated through the following equation:

$$CE = CEF \cdot E \quad (1)$$

where  $CE$  is the carbon emitted due to consumption,  $EC$  the energy consumed, measured in  $(GJ)$ , and  $CEF$  the Carbon Emission Factor, measured in  $\left(\frac{kgCO_2}{GJ}\right)$ . The aforementioned techniques were described step-by-step and then categorized into levels as seen in Table 1. In SLA the object is created by selectively curing a polymer resin layer-by-layer using an ultraviolet (UV) laser beam. SLS is a powder bed printing technology. It uses a high-power laser to sinter small particles of polymer powder into a solid structure, tracing the geometry of digitally sliced CAD models layer by layer and working from the bottom of the part upwards. EBM [19] is a process where high-velocity electrons concentrated into a narrow beam that are directed towards the work piece, creating heat, and vaporizing the material. LENS [20] uses computer-controlled lasers that, weld air-blown streams of metallic powders into custom parts and manufacturing molds. In FDM [21] an object is built by depositing selectively melted material in a predetermined path, layer by layer. Further description of these techniques is presented in Table 1.

The three-level approach [5] was adapted to the AM techniques as seen in Fig. 1. Process level includes CE from the energy consumed during the process and are mainly caused by the electrical energy consumption of the laser. At Machine level, the emissions of the process level increase by the emissions of the auxiliary equipment and the consumables, namely every action that the printer has to perform in order to function properly, depending on the AM process. Lastly, the System level includes CE from the Machine level plus CE from pre and post-processing along with the ones of the material consumption.

#### 4 Framework for CE Calculation for AM

A framework is proposed, to allow for CE calculation for every AM method. This will derive from the generalization of the “Levels method” used above in the previous techniques. Thus, it can be said that the CE at the Process level ( $CE_{process}$ ) come exclusively by the energy spent for curing ( $E_{process}$ ):

$$CE_{process} = CEF_{process} \cdot E_{process} \quad (2)$$

In the Machine level the carbon footprint depends on the energy spent at the process level, by the auxiliary equipment ( $CE_{auxiliary}$ ) and by the consumables ( $CE_{i,cons}$ ).

$$CE_{machine} = CE_{process} + CE_{aux} + \sum_i CE_{i,cons} \quad (3)$$

Which can also be written as:

$$\begin{aligned} CE_{machine} &= CE_{process} + CE_{auxiliary\ equipment} + \sum_i CE_{i,cons} = CE_{process} + CEF_{aux} \cdot E_{aux} \\ &+ \sum_i CEF_{i,cons} \cdot Q_{i,cons} \end{aligned} \quad (4)$$

where ( $CEF_{aux}$ ) is the CE factor of the auxiliary equipment consumption, ( $E_{aux}$ ) the energy required by the auxiliary equipment, and ( $Q_{i,cons}$ ) the quantity of the consumables used for the creation of the final product.



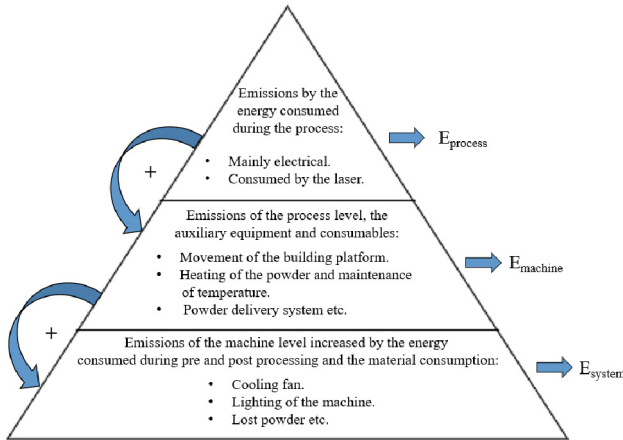
**Table 1.** Level categorization of AM techniques (P-Process, M-Machine, S- System)

AM technique	Levels	Steps
SLA	P	<ul style="list-style-type: none"> <li>• Laser beam will harden actual part geometry</li> </ul>
	M	<ul style="list-style-type: none"> <li>• Resin dispensation</li> <li>• Build platform is lowered</li> <li>• Laser unit directs UV beam to a reflective mirror</li> <li>• Galvo motor system directs beam at the bottom of the resin tank</li> <li>• Support structures layer is hardened</li> <li>• Build platform rises peeling the part from the bottom of the tank</li> <li>• Re-coater sweeps the surface</li> </ul>
	S	<ul style="list-style-type: none"> <li>• Design</li> <li>• Print preparation software</li> <li>• Instructions sent to printer</li> <li>• Chemical bath</li> <li>• Post-curing</li> </ul>
SLS	P	<ul style="list-style-type: none"> <li>• Focused beam directed to the powder surface a cross-section of the part geometry</li> </ul>
	M	<ul style="list-style-type: none"> <li>• Powder pre-heating</li> <li>• Roller dispenses the powder</li> <li>• Laser unit directs a beam to a reflective mirror</li> <li>• Powder delivery system moves up</li> <li>• Platform lowers by one layer</li> <li>• Re-coater distributes the next layer of powder and excess powder is captured in the collection container</li> <li>• Part and chamber cool down</li> </ul>
	S	<ul style="list-style-type: none"> <li>• Design</li> <li>• Print preparation software</li> <li>• Instructions sent to printer</li> <li>• Part cleaning</li> </ul>
EBM	P	<ul style="list-style-type: none"> <li>• The electron beam moves selectively causing the powder particles to fuse together</li> </ul>
	M	<ul style="list-style-type: none"> <li>• Build platform is pre-heated</li> <li>• Roller dispenses the powder</li> <li>• Electromagnetic coils point the beam towards the desired points of the build platform</li> <li>• Build platform is moved down one layer</li> <li>• Powder delivery system moves up</li> <li>• The re-coater distributes a new layer of powder</li> </ul>
	S	<ul style="list-style-type: none"> <li>• Design</li> <li>• Print preparation software</li> <li>• Instructions sent to printer</li> <li>• Polishing of the part</li> </ul>

*(continued)*

**Table 1.** (continued)

AM technique	Levels	Steps
LENS	P	<ul style="list-style-type: none"> <li>The metal melts at the focal point of the laser</li> </ul>
	M	<ul style="list-style-type: none"> <li>Inert shroud gas distribution</li> <li>A laser beam created by a laser generator is focused through a lens onto the workpiece</li> <li>The powder-feed system regulates the mass flow</li> <li>The metal solidifies</li> <li>The head moves in the <i>z-axis</i></li> </ul>
	S	<ul style="list-style-type: none"> <li>Design</li> <li>Print preparation software</li> <li>Instructions sent to printer</li> <li>The part is heat-treated/ machined etc</li> </ul>
FDM	P	<ul style="list-style-type: none"> <li>The material is distributed to create the part</li> </ul>
	M	<ul style="list-style-type: none"> <li>The extrusion head is automatically fed by the system</li> <li>Build chamber is pre-heated</li> <li>Build platform rises to initial position</li> <li>A few layers of material are distributed as a support</li> <li>The build platform moves down</li> </ul>
	S	<ul style="list-style-type: none"> <li>Design</li> <li>Print preparation software</li> <li>Instructions sent to printer</li> </ul>



**Fig. 1.** Levels of AM processes.

The consumables can either be liquid ( $CE_{fluid}$ ) or gas ( $CE_{gas}$ ):

$$\sum_i CE_{i,cons} = CE_{gas} + CE_{fluid} \tag{5}$$

Regarding the auxiliary equipment, any of the followings can be included depending on the AM method used

$$\begin{aligned}
 CE_{auxiliaryequipment} = & CE_{materialdispenser} + CE_{buildplatformmotor} + CE_{galvomotorsystem} \\
 & + CE_{recoater} + CE_{heater} + CE_{laserunit} + CE_{pressure} + CE_{gasdispenser} \\
 & + CE_{headmotor} + CE_{lighting}
 \end{aligned} \tag{6}$$

Thus, every method needs a material dispenser whether it is liquid, powder or solid ( $CE_{materialdispenser}$ ). Some methods have a moving building platform ( $CE_{buildplatformmotor}$ ) on which the product is being built, while in others it is the head that moves layer by layer ( $CE_{headmotor}$ ). To ensure the smoothness of each layer recoaters are sometimes necessary ( $CE_{recoater}$ ). Accordingly, there are methods that need a heater ( $CE_{heater}$ ) for the right composition of the material, while most of the printers have some light for the easier use of the machine ( $CE_{lighting}$ ). Regarding the laser-based methods, CE are created by both the galvo motor system ( $CE_{galvomotorsystem}$ ) and the laser unit ( $CE_{laserunit}$ ). Lastly, special conditions may require the use of gas ( $CE_{gasdispenser}$ ) or pressure ( $CE_{pressure}$ ) in the building environment.

Table 2 presents the aforementioned framework, as described.

**Table 2.** CE framework for AM (P-Process, M-Machine, S- System)

Level	Procedure	Equation
P	Energy spent during curing	$CE_{process} = CEF_{process} \cdot E_{process}$
M	Energy spent at the process level and by the auxiliary equipment and the consumables	$  \begin{aligned}  CE_{machine} = & CE_{process} \\  & + CE_{aux} + \sum_i CE_{i,cons} \\  = & CE_{process} + CEF_{aux} \cdot E_{aux} \\  & + \sum_i CEF_{i,cons} \cdot Q_{i,cons}  \end{aligned}  $
S	Energy spent at the machine level, for the material production, transport, and disposal and by pre/post processing	$  \begin{aligned}  CE_{system} = & CE_{machine} \\  & + \sum_i (CE_{i,transp} + CE_{i,prod} \\  & + CE_{i,disp}) + CE_{pre-process} \\  & + CE_{post-process}  \end{aligned}  $

## 5 Discussion

Carbon emissions in AM are caused mostly due to the energy consumption that this technique requires at process, machine, and system level, by the auxiliary equipment and the consumables, by the production, transportation and disposal of materials, as well as by the pre and post processing. The framework presented in this work suggests a simple, yet effective approach of estimating the CE of every AM technique. The most common source of CE for all three levels is the electrical energy spent. The amount of energy spent for every step multiplied by a specific Carbon Emission Factor (CEF) results into the CE of this step.

This paper examines AM from a different point of view, the one concentrating on the carbon footprint of the process, in contrast with the majority of energy-spent focused research that has been done this far. It suggests a holistic framework estimating the carbon emission of every AM technique and doesn't focus on just one process. This is necessary, especially now that green manufacturing plays such an important role due to the increasing climate change. Nevertheless, being at an early stage the aforementioned framework comes with some limitations. Only the electrical energy spent for every task is taken under consideration.

## 6 Conclusions and Future Outlook

Nowadays, a framework estimating the CE of every AM technique should be considered not only helpful but also necessary to ensure the sustainability of the process. This can be done by dividing the processes into steps which will then be categorized into levels. Once the energy spent is estimated, then the carbon footprint can be calculated.

In future works, a more detailed determination of carbon emission factors should be included to find which level of AM is the most environmentally harmful. Additionally, some ways of reducing the carbon emissions should be suggested. The same applies for the materials used. Thus, examining all the required parameters we will see which one, if changed, will give the desired outcome.

## References

1. ASTM International, Additive Manufacturing - ASTM International, p. 1 (2017)
2. Citarella, R., Giannella, V.: Additive manufacturing in industry. *Appl. Sci.* (Switzerland) **11**(2), 1–3 (2021). <https://doi.org/10.3390/app11020840>
3. Bikas, H., Stavropoulos, P., Chryssolouris, G.: Additive manufacturing methods and modelling approaches: a critical review. *Int. J. Adv. Manufact. Technol.* **83**(1–4), 389–405 (2015). <https://doi.org/10.1007/s00170-015-7576-2>
4. Stavropoulos, P., Foteinopoulos, P.: Modelling of additive manufacturing processes: a review and classification. *Manufact. Rev.* **5**. EDP Sciences (2018). <https://doi.org/10.1051/mfreview/2017014>
5. Panagiotopoulou, V.C., Stavropoulos, P., Chryssolouris, G.: A critical review on the environmental impact of manufacturing: a holistic perspective. *Int. J. Adv. Manufact. Technol.* **118**(1–2), 603–625 (2021). <https://doi.org/10.1007/s00170-021-07980-w>

6. Peng, B., Zheng, C., Wei, G., Elahi, E.: The cultivation mechanism of green technology innovation in manufacturing industry: from the perspective of ecological niche. *J. Clean. Prod.* **252**, 119711 (2020). <https://doi.org/10.1016/j.jclepro.2019.119711>
7. Kellens, K., Mertens, R., Paraskevas, D., Dewulf, W., Duflou, J.R.: Environmental impact of additive manufacturing processes: does am contribute to a more sustainable way of part manufacturing?. *Procedia CIRP* **61**, no. Section 3, 582–587 (2017). <https://doi.org/10.1016/j.procir.2016.11.153>
8. Khalid, M., Peng, Q.: Sustainability and environmental impact of additive manufacturing: a literature review, 328–332 (2020). <https://doi.org/10.14733/cadconf.2020.328-332>
9. Khosravani, M.R., Reinicke, T.: On the environmental impacts of 3D printing technology. *Appl. Mater. Today* **20**, 100689 (2020). <https://doi.org/10.1016/j.apmt.2020.100689>
10. Tang, Y., Mak, K., Zhao, Y.F.: A framework to reduce product environmental impact through design optimization for additive manufacturing. *J. Clean. Prod.* **137**, 1560–1572 (2016). <https://doi.org/10.1016/j.jclepro.2016.06.037>
11. Verma, A., Rai, R.: Energy efficient modeling and optimization of additive manufacturing processes. In: 24th International SFF Symposium - An Additive Manufacturing Conference, SFF 2013, no. 1, pp. 231–241 (2013)
12. Fredriksson, C.: Sustainability of metal powder additive manufacturing. *Procedia Manufact.* **33**, 139–144 (2019). <https://doi.org/10.1016/j.promfg.2019.04.018>
13. Gebler, M., Schoot Uiterkamp, A.J.M., Visser, C.: A global sustainability perspective on 3D printing technologies. *Energy Policy* **74**, 158–167 (2014). <https://doi.org/10.1016/j.enpol.2014.08.033>
14. Fysikopoulos, A., Pastras, G., Alexopoulos, T., Chryssoulouris, G.: On a generalized approach to manufacturing energy efficiency. *Int. J. Adv. Manufact. Technol.* **73**(9–12), 1437–1452 (2014). <https://doi.org/10.1007/s00170-014-5818-3>
15. Yang, Y., Li, L., Pan, Y., Sun, Z.: Energy consumption modeling of stereolithography-based additive manufacturing toward environmental sustainability. *J. Ind. Ecol.* **21**, S168–S178 (2017). <https://doi.org/10.1111/jiec.12589>
16. Ma, F., Zhang, H., Hon, K.K.B., Gong, Q.: An optimization approach of selective laser sintering considering energy consumption and material cost. *J. Clean. Prod.* **199**, 529–537 (2018). <https://doi.org/10.1016/j.jclepro.2018.07.185>
17. Priarone, P.C., Ingarao, G., Lunetto, V., Di Lorenzo, R., Settineri, L.: The role of re-design for additive manufacturing on the process environmental performance. *Procedia CIRP* **69**(May), 124–129 (2018). <https://doi.org/10.1016/j.procir.2017.11.047>
18. Balogun, V.A., Kirkwood, N., Mativenga, P.T.: Energy-consumption-and-carbon-footprint-analysis-of-fused-deposition-modelling.doc. **6**(8), 1–6 (2015)
19. Holcomb, M.H.: An introduction to electron beam therapy. *Radiol. Technol.* **42**(3), 138–143 (1970)
20. Laser Engineered Net Shaping (2001). <https://doi.org/10.1201/9780203910795.ch12>
21. Hiemenz, J.: 3D Printing With FDM, Additive Manufacturing, pp. 1–5 (2008)





**Open Access** This chapter is licensed under the terms of the Creative Commons Attribution 4.0 International License (<http://creativecommons.org/licenses/by/4.0/>), which permits use, sharing, adaptation, distribution and reproduction in any medium or format, as long as you give appropriate credit to the original author(s) and the source, provide a link to the Creative Commons license and indicate if changes were made.

The images or other third party material in this chapter are included in the chapter's Creative Commons license, unless indicated otherwise in a credit line to the material. If material is not included in the chapter's Creative Commons license and your intended use is not permitted by statutory regulation or exceeds the permitted use, you will need to obtain permission directly from the copyright holder.





# Competencies to Address the Industrial Additive Manufacturing Towards Sustainable Production

Gustavo Melo<sup>1</sup> , Alexander Kies<sup>2</sup> , Stefanie Paluch<sup>2</sup> ,  
and Johannes Henrich Schleifenbaum<sup>1</sup> 

<sup>1</sup> Chair for Digital Additive Production DAP, RWTH Aachen University, 52074 Aachen, Germany

{gustavo.melo, johannes.henrich.schleifenbaum}@dap.rwth-aachen.de

<sup>2</sup> Chair for Services and Technology Marketing TIME\_STM, RWTH Aachen University, 52074 Aachen, Germany

{kies, paluch}@time.rwth-aachen.de

**Abstract.** Since the North Rhine-Westphalia (NRW) region is currently undergoing a structural change towards a CO<sub>2</sub> neutral energy supply, the use of additive manufacturing (AM) can offer great potential to produce in a more sustainable way. AM can also offer opportunities for industry with regard to other aspects, since production complexity can also be reduced, and time-to-market shortened at the same time. Against this background of increasing importance of AM, this study has the focus to find out what competencies an employee in AM should have in order to establish him/herself in this area in the future and successfully use AM in the industry. For this purpose, problem-centered and guided expert interviews were conducted with 19 experts from different industries. The interviews were then transcribed and evaluated using Mayring's content analysis. A key finding of this work is that knowledge of technology and materials, the ability to part identification, and a basic understanding of the process chain in AM are among the most important hard skills for a future employee in AM. Regarding soft skills, the willingness to openly exchange ideas, the ability to work in a team in conjunction with good communication skills, a conscientious approach to work and the right mindset are emphasized. In conclusion, regarding structural change in NRW, it is clear from the interviews that the experts particularly suggest opportunities in the area of sustainability, but also greater collaboration within companies and universities involved in AM.

**Keywords:** Additive Manufacturing · Sustainable production · Competencies · Upskilling and Reskilling

## 1 Introduction

Additive manufacturing (AM) is now used in many industrial manufacturing processes. It is seen as a key technology for the current industrial structural change and many companies are intensively dealing with the different printing processes, materials and economic use [1]. To do this, employees in the respective industries must learn new

skills and also already have knowledge from their university or school education. The aim of this work is to find out which competencies, that comprise knowledge, skills and attitudes, are of essential importance in this context. Furthermore, the study deals with the question of which technologies and materials are preferably used in additive manufacturing, especially in the NRW region, and which of these could become relevant in the future [2].

This paper first explains the theoretical basis of additive manufacturing in current industrial applications, the technology maturity of individual printing processes and materials, and the existing and lacking knowledge of AM workers. Afterwards, the procedure of the qualitative content analysis is explained. The preparation and follow-up of the conducted problem-centered and guideline-based expert interviews, as well as the result evaluation and analysis are also presented. Finally, the results are discussed, taking into account possible limitations and the actual derivation of recommendations for industry, trainers and universities.

## **2 State of the Art**

### **2.1 Additive Manufacturing**

Additive manufacturing - often also called 3D printing or rapid prototyping - belongs to the industrial manufacturing processes. It represents a new category in manufacturing technology in addition to classical processes. A distinction is made between subtractive manufacturing processes, such as machining, milling or turning, and formative manufacturing processes, such as casting or forging. Additive manufacturing is a layer-based automated manufacturing process of physical objects based on three-dimensional computer aided design (CAD) files [3]. All additive manufacturing methods in the printing process do not require an object-dependent tool. However, the entire process chain is counted as additive manufacturing. This includes the design, the selection of the appropriate technology and materials, the parameter settings or calibration of the printer, the monitoring of the printing process and the post-processing. Without a series of post-processing steps, the components are often not usable in the industries under consideration, automotive, aerospace and energy [4].

Manufacturing with AM therefore requires expertise in the different process steps of the AM process chain and also the linking of the steps for a smooth flow of the entire AM process chain.

### **2.2 Typical Areas of Application**

To apply additive manufacturing, it is worth looking at the advantages over traditional manufacturing technologies. One advantage is weight reduction through intelligent design, where material is only added where forces need to be absorbed. This saves both material and fuel, helping to improve resource efficiency and reduce emissions. Some components whose conventional design is already complex can be improved to any degree of complexity through additive manufacturing [5]. For example, channels for flow control were applied to an impeller with additively manufactured blades.



Additive manufacturing can also combine new materials, such as certain high-strength, temperature-resistant, weather- and moisture-resistant metal alloys or polymers, whose use was not previously possible due to the material properties at room temperature or slow cooling rates of traditional manufacturing techniques. A common application of AM is prototyping, which contributes greatly to developing new innovations, merging multiple components, or redesigning. It can also be applied to the production of low volume parts, e.g. spare parts or the aftermarket of discontinued models or the customizing of cars or consumer goods [6].

### 3 Methodology

Our exploratory study to identify what competencies are required of employees in additive manufacturing consists of 19 problem-centered expert interviews [7]. We selected experts based on multi-year experience in application of additive manufacturing technologies in the field and recruited them via the platform LinkedIn. Industries in which our experts are active include aerospace, automotive, energy among others. The interviews lasted from 40 to 90 min. For the interviews, we designed a semi-structured interview guideline that consisted of four main parts that investigated the AM-technology applied by experts and questions on skill requirements of employees (Green skills, digital skills, hard and soft skills). All interviews were audio-recorded and then transcribed. All 291 pages of transcript were subjected to thematic analysis according to Mayring [8] using the software MAXQDA. Codes were developed by iteratively moving through the data in multiple cycles and subsequently developing categories in an inductive approach. Coding categories emerged in a step-by-step process from open-ended observations of the researchers and were merged to a final set of themes [9]. A total of eight categories with an average of five subcategories were discovered.

### 4 Results

One of the questions of this study deals with finding out which skills are necessary for the future AM employee to establish himself in this field in the future. In addition to the hard skills, the questionnaire also addresses the soft skills that future employees need, as mentioned by the participants. In addition to the “hard” and “soft”, it is also important to know how these can best be taught in the future. Therefore, direct implications to educational content were identified via the interviews. The second part of the research questions deals, among other things, with which technologies, materials, applications and trends could be specifically relevant for the NRW region in the future. The main findings are presented in short in the Table 1 and discussed in depth in the following subchapters.

#### 4.1 Hard Skills

Among many skills mentioned, the focus is on process-related AM knowledge, material knowledge, quality management and part screening, which are discussed in depth as follows.

**Table 1.** Key findings from 19 interviews related to hard and soft skills, educational and regional implications

Category	Development/Conclusions
Hard skills	<ul style="list-style-type: none"> <li>• Process-related AM knowledge, material knowledge, quality management and part screening</li> </ul>
Soft skills	<ul style="list-style-type: none"> <li>• Open for innovation, way of working, ability to work in a team, way of thinking</li> </ul>
Educational implications	<ul style="list-style-type: none"> <li>• Theoretical AM knowledge, dual study for practice knowledge, material science, technology potential related to use case, teaching based on standards, use of enabling technologies</li> </ul>
Regional implications	<ul style="list-style-type: none"> <li>• Sustainability and sustainable production, open source, great potential to SMEs, digital warehouse for storage of spare parts</li> </ul>

Process-related AM knowledge was mentioned by 17 out of 19 participants in this study as an important “hard skill” that future employees in the AM area should have. This is about developing a basic understanding of all processes within the process chain and not just being a specialist in one area. The participants emphasize the advantage that future employees could draw from such a skill. These are, for example, possibilities of scaling, faster problem solving, but also the understanding of what limitations there are in 3D printing.

*“Every additive process has different sizes that it can scale. [...]. And for that it’s no enough to know how I design what, you have to understand the technology. Not in detail, but you need to understand how the process is, what constraints and function it has.” (IP14, lines 170–177)*

The experts also see material knowledge as an important hard skill in additive manufacturing. The participants emphasize that in AM the challenge often lies in knowing which material is suitable for which product and what possibilities the materials give you in the first place when it comes to printing products. This is because the participants emphasize that materials have special properties that should be known in order to achieve the best possible component. Therefore, they see knowledge in the field of materials science as mandatory for AM.

As with all manufacturing processes, the quality of the component also plays a major role in AM, as several experts note in the interviews. Therefore, knowledge in this area is also crucial for the future AM employee. For example, one should know how to deal with standards and where to find them. The experts are concerned to show that the AM engineer has a certain understanding of quality assurance in AM and also deals with it.

The experts increasingly note in the interviews that it is crucial for companies to filter which parts are to be produced by 3D printing in the first place. Therefore, they see part screening, known as well as part identification, as an important “hard skill”. It is about identifying which parts are suitable for AM and then creating a business case for the company. One could see this skill as an initiator to enable an AM process and to optimize it in the further course.

*“That will really depend on the component, in order to find out the component, one goes through screenings, i.e. small numbers of parts, and then looks at what properties the component must have” (IP5, line 172–174).*

With regard to other technological competencies, it is emphasized that it is important not only to specialize in a single process, but to acquire knowledge of all current processes. The participants also note that basic economic knowledge is also useful. This is important in order to establish the technology, because positive financial results and the correct calculation of costs, even the best process has no chance in industry. Furthermore, the experts emphasize that certain IT competencies is always important because one comes into contact with a lot of software and data in the field of AM. In addition, it is often mentioned that knowledge of CAD and Python would be an advantage for future employees. Regarding sustainability expertise in AM, participants state that a common and logical sense is important in this context, but also awareness and understanding of the product life cycle, i.e. from its creation, through material procurement to the finished product.

## 4.2 Soft Skills

The interviewees mentioned various personal and social qualities, which are summarized in the following subcategories: Open for innovation, way of working, ability to work in a team, way of thinking.

From the interview material, various characteristics can be summarized under the term “open for innovation”. The majority of respondents mentioned the aspect of open exchange with different networks or other sectors. Particularly with regard to innovation, since AM is evolving rapidly, the willingness to engage in open exchange and good communication skills are advantageous in order to learn from the experiences of others and to obtain new inspiration and ideas and thus drive innovation forward.

*“It’s a field where you really rely on innovation and you learn a lot through network in the end too [...]” (IP9, lines 306–309)*

Furthermore, the interview participants named various characteristics that can be summarized in the subcategory “way of working”. Particularly regarding the protection of intellectual property, a conscientious way of working is considered important by the experts. In addition to working with Non-Disclosure Agreement, which are particularly relevant in the area of research and development and thus also in many AM areas, several participants also mentioned the responsible handling of IT data and the conscientious implementation of their own company security guidelines. As additive manufacturing consists of many different subject areas, the participants emphasize that the ability to work in a team and, as a result, good communication skills are advantageous. In particular, when determining in which areas or for which components 3D printing can be used, it would be necessary to work in interdisciplinary teams. But good communication is also necessary within the process chain in additive manufacturing so that, for example, components can be optimized through adapted CAD models.

The subcategory “way of thinking” is mainly composed of two soft skills that are mentioned by the interviewees: Interdisciplinary Thinking and Mindset. As already

mentioned, AM is composed of different topics in the process chain. The participants state that a holistic view in connection with a linked way of thinking is relevant. It is very important to understand the connections and interactions between processes and to have interdisciplinary knowledge.

*“Employees are very successful when they keep their eyes on the big picture. [...] A more global approach, don’t just have the skills in one area.” (IP10, lines 245–249)*

Another soft skill mentioned by the participants in the context of way of thinking is mindset. On the one hand, this refers to the fascination with technology, whereby the employee has a high willingness to learn and is also motivated to advance and develop the technology. On the other hand, the interviewees mention that it is important to break away from conventional manufacturing processes and to think in terms of AM structures in order to check the possibility of additive manufacturing directly during product development.

### 4.3 Educational Implications

Based on the interviews, it can be seen that it is particularly important to the participants to convey sufficient theoretical AM knowledge in teaching or training. Universities in particular are cited here as a crucial instrument whose task it is to implement this. The participants made it clear that there should be a stronger focus on theoretical AM knowledge at universities, as this is often not sufficiently covered in the degree courses. The experts feel that there is a lack of depth and comprehensiveness with regard to the teaching of theoretical AM knowledge.

In addition to the theoretical AM knowledge that should be taught, the study also suggests that the application of theoretical knowledge is often missing in teaching. In the interviews, the experts convey the impression that this aspect in particular should not be neglected in teaching. The combination of practice and theory in a kind of dual course of study is also suggested, among other things.

*“[...] I need theory modules, but I also need practice, so of course you could have a kind of dual course of study where you are perhaps in the company, but also parallel somewhere at the university” (IP4, lines 543–545).*

In addition to practice, the experts also attach great importance to the topic of materials science. They explain that knowledge of materials in AM plays an essential role in being able to develop the potential of the technology. This is because it is possible to assess the requirements of the materials and what is possible with them. Therefore, they see it as the duty of teaching not to neglect this in studies or training.

These are two subcategories which were mentioned sporadically by experts and offer an interesting educational approach: “technology potential meets use case & teaching based on standards”. The screening of business cases is, as already mentioned in the “hard skills”, an important skill in AM. It would therefore be good to include in teaching which technologies fit which type of use case. The subcategory teaching based on standards also provides an exciting aspect for a possible approach to “new” learning methods.

Standards play a major role in AM and can be found practically throughout the process chain. On the basis of these, a kind of basic study could be derived, which covers a large part of the competencies required in AM.

Regarding trends and future development of AM, the participants state that they do not see a breakthrough of the technology in the future, but rather that there will be a gradual improvement and thus industrialization of AM technology, so that the market of AM will grow and more companies will take up additive manufacturing processes to take advantage of AM in the development process. In addition, several participants see that due to industrialization, the technology is increasingly used in series production. In addition to the future development of AM technologies and their materials, several interviewees also discuss various technologies that are summarized in the category “enabling technologies”. These include all technologies that can be used in addition to the actual AM manufacturing processes. Several interview participants mention virtual or augmented reality (VR/AR) from teaching, through AM product design until live assistance during AM production and quality assurance.

#### **4.4 Regional Implications**

The experts see the first opportunity for NRW in the area of sustainability. Particularly when it comes to creating closed resource cycles or producing more sustainably, they see potential in the area of AM that could be exploited in NRW. In addition to sustainability, the idea of collaboration or “open source” is also suggested. The experts note that open exchange between a wide range of bodies could represent an opportunity for NRW and is often given little or no consideration. In addition, the interview partners mention isolated aspects that represent exciting opportunities for NRW. The two most interesting mentioned ones are the great opportunity for SMEs to benefit from AM and a project in the context of the storage of spare parts in NRW. The experts outlined the options available to companies, since AM is not widespread in many sectors and it is precisely here that funding projects could help to drive forward structural change in NRW with regard to AM. Projects from the federal government and the EU are mentioned frequently.

## **5 Conclusions**

The aim of this study is to show which skills future employees will need in the field of AM. In addition, a relationship between additive manufacturing and structural change in NRW is to be presented. The focus here is on determining which of the processes are currently relevant and which opportunities AM offers for NRW. Among the hard skills were emphasized on process-related AM knowledge, material knowledge, quality management and part screening. As soft skills, the interviewees mentioned as the most relevant the open for innovation, way of working, ability to work in a team, way of thinking. In addition to the “hard” and “soft” skills, direct implications to educational content were identified. The present study provides exciting new insights in the area of learning methods. For example, it highlights the possibility of standards-based teaching and emphasizes the importance of hands-on experiences during training. Moreover, AR/VR were mentioned as new trend to be considered in this educational field of AM. Lastly,

the research dealt, among other things, with which technologies, materials, applications and trends which could be specifically relevant for the NRW region in the future.

## References

1. Wong, K.V., Hernandez, A.: A review of additive manufacturing. *Int. Sch. Res. Netw. ISRN Mech. Eng.* (2012). <https://doi.org/10.5402/2012/208760>
2. Pinzone, M., Fantini, P., Perini, S., Garavaglia, S., Taisch, M., Miragliotta, G.: Jobs and skills in industry 4.0: an exploratory research. In: Lödging, H., Riedel, R., Thoben, K.-D., von Cieminski, G., Kiritsis, D. (eds.) *APMS 2017. IAICT*, vol. 513, pp. 282–288. Springer, Cham (2017). [https://doi.org/10.1007/978-3-319-66923-6\\_33](https://doi.org/10.1007/978-3-319-66923-6_33)
3. Gibson, I., Rosen, D., Stucker, B.: *Additive Manufacturing Technologies: 3D Printing, Rapid Prototyping, and Direct Digital Manufacturing*, Second Edition, 2nd ed. Springer New York (2015). <https://doi.org/10.1007/978-1-4939-2113-3>
4. Abdulhameed, O., Al-Ahmari, A., Ameen, W., Mian, S.H.: Additive manufacturing: challenges, trends, and applications. *Adv. Mech. Eng.* **11**(2), 1687814018822880 (2019). <https://doi.org/10.1177/1687814018822880>
5. Ngo, T.D., Kashani, A., Imbalzano, G., Nguyen, K.T.Q., Hui, D.: Additive manufacturing (3D printing): a review of materials, methods, applications and challenges. *Compos. B Eng.* **143**, 172–196 (2018). <https://doi.org/10.1016/J.COMPOSITESB.2018.02.012>
6. Prakash, K.S., Nancharaih, T., Rao, V.V.S.: Additive manufacturing techniques in manufacturing -an overview. *Mater. Today: Proc.* **5**(2), 3873–3882 (2018). <https://doi.org/10.1016/J.MATPR.2017.11.642>
7. Bogner, A., Littig, B., Menz, W.: Introduction: expert interviews — an introduction to a new methodological debate. *Interviewing Experts* 1–13 (2009). [https://doi.org/10.1057/9780230244276\\_1](https://doi.org/10.1057/9780230244276_1)
8. Mayring, P.: *Qualitative Inhaltsanalyse. Grundlagen und Techniken* (2015). [http://ebooks.cia.ndo.com/book/in-dex.cfm/bok\\_id/1875625](http://ebooks.cia.ndo.com/book/in-dex.cfm/bok_id/1875625)
9. Patton, M.Q.: *Qualitative Research and Evaluation Methods: Theory and practice*; Fourth Edition (2015)

**Open Access** This chapter is licensed under the terms of the Creative Commons Attribution 4.0 International License (<http://creativecommons.org/licenses/by/4.0/>), which permits use, sharing, adaptation, distribution and reproduction in any medium or format, as long as you give appropriate credit to the original author(s) and the source, provide a link to the Creative Commons license and indicate if changes were made.

The images or other third party material in this chapter are included in the chapter's Creative Commons license, unless indicated otherwise in a credit line to the material. If material is not included in the chapter's Creative Commons license and your intended use is not permitted by statutory regulation or exceeds the permitted use, you will need to obtain permission directly from the copyright holder.





# Modeling Carbon Border Tax for Material-Based GHG Emission and Costs in Global Supply Chain Network

Takaki Nagao<sup>1</sup>, Hiromasa Ijuin<sup>1</sup>, Keisuke Nagasawa<sup>2</sup>, and Tetsuo Yamada<sup>1</sup>(✉)

<sup>1</sup> Department of Informatics, The University of Electro-Communications, 1-5-1 Chofugaoka,  
Chofu 182-8585, Tokyo, Japan

{n2130089,i2040014}@edu.cc.uec.ac.jp, tyamada@uec.ac.jp

<sup>2</sup> Graduate School of Advanced Science and Engineering, Hiroshima University, 1-4-1  
Kagamiyama, Higashi-Hiroshima, Hiroshima 739-8527, Japan  
nagasa-kei@hiroshima-u.ac.jp

**Abstract.** One of the problems in an environmental policy is carbon leakage, which is increasing GreenHouse Gas (GHG) emissions as an adverse effect due to the production shift from countries with strict climate change policies to those with careless ones. In this situation, Carbon Boarder Adjustment (CBA) is considered as a countermeasure for mitigating GHG emission and carbon leakage globally, with European Union (EU) agreeing to introduce the CBA in 2026. CBA is expected to have huge impact upon a global supply chain network. The reasons of it are that total cost and GHG emissions on a global supply chain network have been influenced by the different procurement cost, customs duty and GHG level from each country by the price level, the governmental policy, and the energy mix. However, it is not revealed how much effect CBA has for the cost, and GHG emission on a global supply chain network. Thus, this study models a global supply chain network with CBA as the intersection of environment and economy. First, a global supply chain network with CBA is modeled and formulated for minimizing the total cost using integer programming. Second, a problem example is prepared with bill of materials for the procurement cost and the GHG emission using life cycle assessment. After that, under the market in the U.S., a numerical experiment is conducted to validate the proposed model. Finally, the effect of CBA is discussed.

**Keywords:** Carbon Border Adjustment Mechanism · Carbon Leakage · Trans Pacific Partnership · Integer Programming · Life Cycle Assessment

## 1 Introduction

Recently, Carbon Boarder Adjustment (CBA) has been agreed upon to be introduced by European Union (EU) council as an economical and environmental scheme for avoiding carbon leakage [1]. Carbon leakage is the adverse effect of environmental policies, due to the production shifts form a country with strong policy to the other country with careless

policy [2]. CBA is one of the countermeasure policies for carbon leakage. Under the CBA, an additional cost as importing tax is imposed based on the difference of climate policy [3].

This CBA has large impact on a global supply chain network [4]. This is because total cost and GreenHouse Gas (GHG) emissions on a global supply chain network have been influenced by the different procurement cost, customs duty and GHG level from each country by the price level and the energy mix [5].

Regarding the literature on CBA and a supply chain, Lim et al. [4] studied EU's CBA in terms of an economic scheme. Resultantly, they concluded that the CBA mechanism was not in line with international trade rules. In addition, it was too costly for the global economy while the goal of preventing climate change was agreeable. According to Martin et al. [6], industrial fields with carbon leakages did not apply to Emission Trade Systems (ETS), which were the regional cap-and-trade for GHG. Kondo et al. [7] analyzed the supplier selections considering GHG emission, and quantitatively showed whether there is a carbon leakage on global supply chain through numerical experiments. Nagao et al. [8] analyzed the impact of disruption for costs on a global supply chain network. However, the CBA based on GHG emission is not considered through modelling of the global supply chain network.

This study models a global supply chain network with CBA as the intersection of environment and economy. It specifically aims to estimate the effect of CBA based on an analysis for a global supply chain network by numerical experiments. The contribution of this paper is a new quantitative evaluation for CBA on the industrial field.

In this study, the Research Questions (RQs) are developed as follows.

RQ1: What is the effect of the cost and the GHG emission on a global supply chain by CBA?

RQ2: What is the CBA rate required to prevent carbon leakage?

## 2 Model and Formulation

In this section, in order to analyze CBA on a global supply chain network, the model and the formulation for numerical experiments are described. Section 2.1 develops the global supply chain model with CBA based on the previous study [8]. In Sect. 2.2, the model is formulated for minimizing total cost and the formulation of CBA based on GHG emission is given.

### 2.1 Model

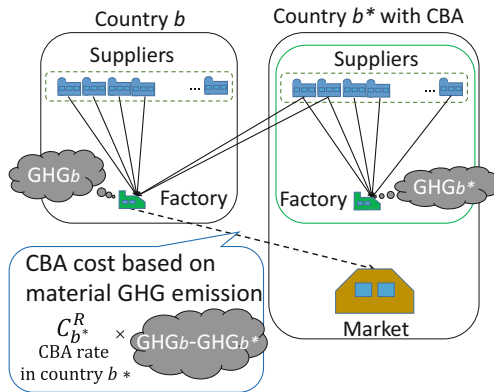
Figure 1 shows CBA cost by material-based GHG emission in the proposed model of this study. When the GHG emission of goods manufactured in non-CBA countries is higher than one domestically produced in the country with CBA, it is assumed that the CBA is imposed. The CBA cost is calculated by multiplying the excess amount of GHG emission for importing products by a given CBA rate. To estimate quantitatively the CBA cost, material-based GHG emissions using Life Cycle Inventory (LCI) database [5] is used by Life Cycle Assessment (LCA) [9].



The global supply chain model is developed based on Nagao et al. [8] with a global supply chain model with customs duty and Trans Pacific Partnership (TPP), which is a comprehensive Free Trade Agreement (FTA). In the model, the product consists of  $N_j$  type parts. Part  $j$  is procured from supplier  $o$  to factory  $p$ , where the product is assembled at factory  $p$ . Then, assembled products are transported to market  $q$ . Meanwhile, the customs duties  $C_{pq}^{TS}$  are imposed when importing goods.

Set of suppliers in countries forming the TPP is defined as group  $G$ , which is a set of supplier cities. Among TPP member countries, the customs duty  $C_{op}^{TS}$  is not imposed. In other cases, importers need to pay customs duty when importing goods. Then, the developed element of the proposed model is CBA scheme. It can be applied when importing parts or products across the border of a country, similar to customs duties.

It is noted that this proposed model is assumed for the strategic planning stage of CBA scheme, where a just-in-time environment is applied similar to Nagao et al. [8], which represents fewer inventory operations [10]. Thus, inventory control with lead time is out of scope in this study.



**Fig. 1.** CBA cost by material-based GHG emission in the proposed model of this study.

The notations used in this study are as follows:

Sets:

$O$ : Set of suppliers,  $o \in O$ .

$G$ : Set of suppliers in countries forming the TPP,  $g \in G, G \subset O$ .

$B$ : Set of country,  $b \in B$ .

$J$ : Set of parts,  $j \in J$ .

$P$ : Set of factories,  $p \in P$ .

$Q$ : Set of markets,  $q \in Q$ .

Decision variables:

$v_{opj}$ : Number of parts  $j$  transported from supplier  $o$  to factory  $p$ .

$v_{pq}$ : Number of products transported from factory  $p$  to market  $q$ .

$k_p$ : Number of products manufactured at factory  $p$ .

$z_{pq}$ : 1 if the route between factory  $p$  and market  $q$  is opened, and 0 otherwise.

$u_p$ : 1 if factory  $p$  is opened, and 0 otherwise.

Evaluation:

$TC$ : Total cost [USD].

$TG$ : Total GHG emission [t-CO<sub>2</sub>eq].

Cost parameters:

$C_{op}^{LC}, C_{pq}^{LC}$ : Logistics cost per unit part and product for transportation.

$C_{oj}^{PC}$ : Procurement cost of procuring per unit part  $j$  by supplier  $o$ .

$C_{op}^{TS}, C_{pq}^{TS}$ : Customs duty per unit part and product on transportation.

$C_p^{MF}$ : Manufacturing cost per product at factory  $p$ .

$C_{pq}^{RT}, C_p^{FC}$ : Fixed cost for opening route from factory  $p$  to market  $q$ , and opening factory  $p$ .

Production parameters:

$N_j$ : Total number of parts  $j$ , consisting of one product.

$N_q$ : Demand for products in market  $q$ .

$M$ : Very large number (Big M).

$F_p$ : Production capacity at factory  $p$ .

$S_{oj}$ : 1 if part  $j$  is supplied by supplier  $o$ , and 0 otherwise.

GHG parameters:

$C_{b^*}^R$ : CBA cost per ton of GHG emission at country  $b^*$  [USD/t-CO<sub>2</sub>eq].

$E_p^{b^*}$ : Non-negative value: The amount of GHG emission produced at factory  $p$  which is higher than one in country  $b^*$  with CBA, and 0 otherwise.

$H^{b^*}$ : Unit GHG emission per one product produced in country  $b^*$  with CBA.

$X_p$ : The amount of GHG emission produced at factory  $p$ .

## 2.2 Formulation

The objective functions are formulated to minimize total cost  $TC$  based on Nagao et al. [8].  $TC$  is comprised from total manufacturing cost  $TMC$ , total transportation cost  $TTC$ , total customs duty cost  $TCDC$ , and total CBA cost  $TCBA$  as shown in Eq. (1).

Objective function:

$$TC = TMC + TTC + TCDC + TCBA \rightarrow \min \quad (1)$$

Consisting items of  $TC$  are set as follows.

$$TMC = \sum_{o \in O} \sum_{p \in P} \sum_{j \in J} C_{oj}^{PC} v_{opj} + \sum_{p \in P} \sum_{q \in Q} C_p^{MF} v_{pq} + \sum_{p \in P} \sum_{q \in Q} C_{pq}^{RT} z_{pq} + \sum_{p \in P} C_p^{FC} u_p \quad (2)$$

$$TTC = \sum_{o \in O} \sum_{p \in P} \sum_{j \in J} C_{op}^{LC} v_{opj} + \sum_{p \in P} \sum_{q \in Q} C_{pq}^{LC} v_{pq} \quad (3)$$

$$TCDC = \sum_{o \in O} \sum_{p \in P} \sum_{j \in J} C_{oj}^{PC} C_{op}^{TS} v_{opj} + \sum_{p \in P} \sum_{q \in Q} C_p^{MF} C_{pq}^{TS} v_{pq} \quad (4)$$

$$TCBA = \sum_{p \in P} E_p^{b^*} C_{b^*}^R \quad (5)$$

$$E_p^{b^*} = \begin{cases} 0, & X_p - k_p H^{b^*} < 0 \\ X_p - k_p H^{b^*}, & X_p - k_p H^{b^*} \geq 0 \end{cases} \quad (6)$$

$$X_p = \sum_{p \in P} \sum_{o \in O} \sum_{j \in J} v_{opj} H_{oj} \quad (7)$$

$TMC$  in Eq. (2) is the sum of the procurement cost of parts, manufacturing cost of products, route opening cost, and factory opening cost.  $TTC$  in Eq. (3) is the sum of transportation cost of parts from suppliers to factories and products from factories to markets.  $TCDC$  in Eq. (4) is the sum of the customs duty cost of parts and products.  $TCBA$  in Eq. (5) is calculated by the rate of CBA in the applied country timed the difference between total GHG emission at factory  $p$  and the expected emission produced only in a CBA country.

Equation (6) calculates  $E_p^{b^*}$  as the difference of GHG emission at factory  $p$  by the expected emission of domestic local supply chain in the country  $b^*$  applied CBA. This Equation means the CBA cost is imposed by using the difference of GHG emission when material-based GHG emission of products produced at factory  $p$  is higher than one produced only in the CBA country  $b^*$ . In Eq. (7), the sum of material-based GHG emission at factory  $p$  is calculated by multiplying the number of transportation parts and the parts GHG emission in supplier  $o$ .

The other constraints are set similar to Nagao et al. [8] for the number of products, parts, transportation volume, demand, opening route/factory, and production capacity at factories, and decision variables for binary and non-negative.

### 3 Problem Example

For conducting numerical experiments, problem examples about product, supply chain, cost and GHG emission of parts, and CBA assumption are given in this section.

To analyze the effect of CBA for a global supply chain network, problem examples are prepared based on Nagao et al. [8] as follows:

- Supply chain network example

13 suppliers are located across countries such as the U.S., China, Malaysia, and Japan. As a candidate location of a factory, four cities are set at Seattle, Shanghai, Kuala Lumpur, and Tokyo, where the products are manufactured using transported parts from suppliers. The manufacturing cost for the product is different from countries. 3,000 manufacturing products units applies as the production capacity for each factory. Seattle in the U.S. is set as a market location, and the demand is 6,000 units.

- Customs duty and TPP example

The customs duty rate for importing parts and products between the U.S. and China is 25%, and that between a TPP country and a non-TPP one is 10%. Between TPP countries, i.e., Malaysia and Japan, customs duty is 0%.

- GHG and cost example

The material-based GHG emission and the procurement cost are vary with parts and countries. Average GHG emissions and average procurement costs of parts in each country are shown in Table 1 [11]. Moreover, so as to illustrate an application of the proposed model to a supply chain design example, the product example and assumptions are same as Urata et al. [12]. In their study, it is assumed that #19 motor is always supplied from Japan. This is because the GHG emission including CO<sub>2</sub> emissions of the motor (#19) is so high that it is about 95% of the total emissions.

**Table 1.** Average GHG emissions and procurement costs of parts in each country [11]

	Average Parts GHG emission [g-CO <sub>2</sub> eq]	Average Parts Procurement cost [USD]
The U.S	117	0.095
Malaysia	249	0.078
China	633	0.086
Japan	103	0.143

- CBA example

It is assumed that the U.S. is applied with CBA in this study. It is imposed when material-based GHG emission for produced products is higher than ones manufactured domestically in the U.S only. The cost is calculated by multiplying the rate  $C_{\text{TheU.S.}}^R$  by the excess amount of GHG emission  $E_p^{\text{TheU.S.}}$ . Three CBA rate are respectively examined as 1, 10, and 100 [USD/t-CO<sub>2</sub>eq] in the experiments.

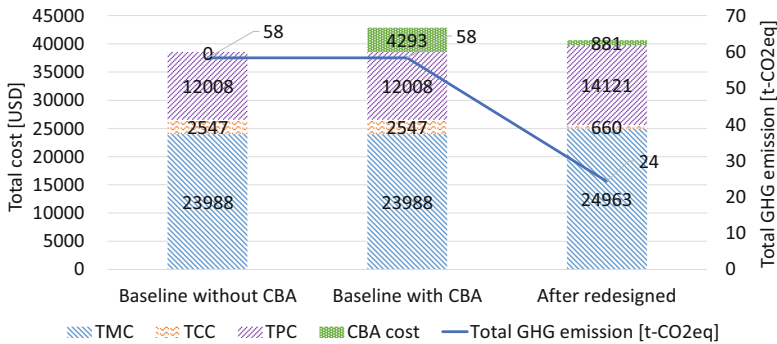
### 4 Result

In this section, the results of numerical experiments by using the formulation and the problem examples in Sects. 2 and 3 are shown and discussed in terms of the CBA rate, the costs, and the GHG emission related to carbon leakages.

Figure 2 shows the results of total cost *TC* and total GHG emission *TG* with a global supply chain as the baseline without CBA, the baseline with CBA by 100 [USD/t-CO<sub>2</sub>eq], and after redesign. It is noted that the CBA was not applied in the only case of baseline without CBA. From Fig. 2, the total cost *TC* was increased by 11% in the case with CBA before redesign, but increased only 5% from the baseline without CBA in the case with CBA after redesign.

After redesigned comparison to the baseline without CBA, the total transportation cost *TTC* was decreased by 74%, and total procurement cost *TPC* was increased by 18%. While the total CBA cost *TCBA* accounts for 10% of the total cost *TC*, that after redesign was only 2% of the total cost. Therefore, it is verified that this model can propose a supply chain reconfiguration to suppress the increment of total cost under CBA. On the other hand, the total GHG emission was decreased by 58% in the case after redesign with CBA. Thus, it is found that CBA rate of 100 [USD/t-CO<sub>2</sub>eq] has influence on the total cost and total GHG emission on the global supply chain network. Furthermore, it is noted that carbon leakages were not observed in this case. In the other numerical experiments, the results for the GHG emission and costs without CBA are not changed with the CBA rate of 1 and 10 [USD/t-CO<sub>2</sub>eq].

Therefore, it is found that CBA by material-based GHG emission has prevented carbon leakages when the CBA is applied to a low GHG country, the U.S. in this study.



**Fig. 2.** The results of total cost *TC* and total GHG emission *TG* with a global supply chain as the baseline without CBA, the baseline with CBA by 100 [USD/t-CO<sub>2</sub>eq], and after redesign

### 5 Conclusion

This study modeled a global supply chain network with CBA as the intersection of environment and economy. It specifically aimed to estimate the effect of CBA based

on an analysis for a global supply chain network by the numerical experiments. The contribution of this study was to model a global supply chain network for analyzing the CBA effect quantitatively using LCA. Answers of RQs developed in Sect. 1 are as follows:

- Answer of RQ1: What is the effect of the cost and the GHG emission on a global supply chain by CBA?

The cost breakdown was changed mainly for the decrease of transportation cost and the increase of total procurement cost when the applied CBA rate was 100 [USD/t-CO<sub>2</sub>eq]. Therefore, the total GHG emission was largely decreased.

- Answer of RQ2: What is the CBA rate required to prevent carbon leakage?

The rate of 1 to 100 [USD/t-CO<sub>2</sub>eq] did not bring carbon leakages. In terms of reducing GHG emission, the rate of 100 [USD/t-CO<sub>2</sub>eq] was appropriate. Moreover, it was found that application of CBA to low GHG level country was effective for preventing the carbon leakage in terms of material-based GHG emission and costs in the experiments.

In this study, CBA was treated as an environmental tax. Nevertheless, industrial production has been influenced by multiple environmental policies. Therefore, further study should consider the combination of the multi-environmental policy such as CBA and carbon tax.

**Acknowledgement.** This study was partially supported by the Japan Society for the Promotion of Science (JSPS), KAKENHI, Grant-in-Aid for Scientific Research (A), JP18H03824, from 2018 to 2023.

## References

1. Council of the EU Press release, Council agrees on the Carbon Border Adjustment Mechanism (CBAM). <https://www.consilium.europa.eu/en/press/press-releases/2022/03/15/carbon-border-adjustment-mechanism-cbam-council-agrees-its-negotiating-mandate/>. Accessed 11 May 2022
2. Carbon Market Watch, Carbon Leakage. <https://carbonmarketwatch.org/2014/08/29/carbon-leakage/>. Accessed 22 Jan 2019
3. Taxation and Customs Union, Carbon Border Adjustment Mechanism. [https://ec.europa.eu/taxation\\_customs/green-taxation-0/carbon-border-adjustment-mechanism\\_en](https://ec.europa.eu/taxation_customs/green-taxation-0/carbon-border-adjustment-mechanism_en). Accessed 6 May 2022
4. Lim, B., Hong, K., Yoon, J., Chang, J. I., Cheong, I.: Pitfalls of the EU's carbon border adjustment mechanism. *Energies*. **14**, (2021). <https://doi.org/10.3390/en14217303>
5. Kokubu, K., Itsubo, N., Nakajima, M., Yamada, T.: Low Carbon Supply Chain Management. Chuokeizai-sha Inc, Tokyo, Japan (2015). (In Japanese)
6. Martin, R., Muûls, M., De Preux, L.B., Wagner, U.J.: On the empirical content of carbon leakage criteria in the EU emissions trading scheme. *Ecol. Econ.* **105**, 78–88 (2014). <https://doi.org/10.1016/j.ecolecon.2014.05.010>
7. Kondo, R., Kinoshita, Y., Yamada, T.: Green procurement decisions with carbon leakage by global suppliers and order quantities under different carbon tax. *Sustainability*. **11**(13), 3710, (2019). <https://doi.org/10.3390/su11133710>

8. Nagao, T., Ijuin, H., Yamada, T., Nagasawa, K., Zhou, L.: COVID-19 disruption strategy for redesigning global supply chain network across TPP countries. *Logistics* **6**(1), 2 (2022). <https://doi.org/10.3390/logistics6010002>
9. Sugiyama, H., Fukushima, Y., Hirao, M., Hellweg, S., Hungerbuhler, K.: Using standard statistics to consider uncertainty in industry-based life cycle inventory databases. *Int. J. Life Cycle Assess* **10**, 399–405 (2012)
10. Salvendy, G.: *Handbook of Industrial Engineering Technology and Operations Management*, 2nd edn. A Wiley-Interscience Publication, 605 Third Avenue, New York, USA (1992)
11. Hayashi, K., Matsumoto, R., Yamada, T., Nagasawa, K., Kinoshita, Y.: Designing a global supply chain network considering carbon tax and trans-pacific partnership agreement. In: *Proceedings of the 2020 the Society of Plant Engineering Japan Spring Conference*, pp. 97–100. The Society of Plant Engineering Japan, Tokyo, Japan (2020) (In Japanese)
12. Urata, T., Yamada, T., Itsubo, N., Inoue, M.: Global supply chain network design and Asian analysis with material-based carbon emissions and tax. *Comput. Ind. Eng.* **113**, 779–792 (2017). <https://doi.org/10.1016/j.cie.2017.07.032>

**Open Access** This chapter is licensed under the terms of the Creative Commons Attribution 4.0 International License (<http://creativecommons.org/licenses/by/4.0/>), which permits use, sharing, adaptation, distribution and reproduction in any medium or format, as long as you give appropriate credit to the original author(s) and the source, provide a link to the Creative Commons license and indicate if changes were made.

The images or other third party material in this chapter are included in the chapter's Creative Commons license, unless indicated otherwise in a credit line to the material. If material is not included in the chapter's Creative Commons license and your intended use is not permitted by statutory regulation or exceeds the permitted use, you will need to obtain permission directly from the copyright holder.



# **Production Systems**





# Integrating Lean Management Principles into Human-Robot Collaboration in Disassembly Cell

Samira Keivanpour<sup>(✉)</sup>

Mathematics and Industrial Engineering Department, Polytechnique Montreal, Montreal, QC,  
Canada

samira.keivanpour@polymtl.ca

**Abstract.** Integrating Industry 4.0 technologies into the circular economy has received much attention in the literature in recent years. Considering the ladder of lansink and circular economy technical cycle, reusing and remanufacturing are preferable to recycling. Disassembly is a crucial process in remanufacturing. Collaborative robots provide semi-autonomous disassembly and could enhance product remanufacturing considering the uncertainties, cost reduction, and circularity of materials. This paper aims to discuss the application of lean practices in a disassembly cell with operators-robots collaboration. A conceptual framework based on the house of lean is proposed to highlight the research perspectives on opportunities of lean philosophy in disassembly operation enabled with industry 4.0 technology.

**Keywords:** Collaborative robots · lean management · disassembly · circular economy · industry 4.0

## 1 Introduction

In sustainable manufacturing, disassembly operation plays a crucial role in remanufacturing and has considerable economic and environmental benefits in materials circularity. Collaborative robots are promising in disassembly operation considering the costs of manual operations, reducing the ergonomic risks for operators, and high investment in automated disassembly. Disassembly planning includes the optimization of the disassembly sequences for minimizing the disassembly time, consumed energy, and related costs. Lean management has several potentials in sustainability and efficiency of disassembly operation with Cobot. This paper aims to integrate the elements of the Lean management model including wastes reduction, problem-solving, visual management, standardization, operational stability, and quality into a disassembly cell with Cobot. To the best of our knowledge, developing a joint application of lean principles in human-robot collaboration disassembly has not received much attention in the literature. There are two main streams of research in the context of cobot disassembling. The first focused on the safety aspects, designing safety zones, minimization of the collision and the second stream is studying the tasks arrangement and operational mechanisms including

sequence planning and performance management. The new stream of research should focus on collaboration rather than coexistence and cooperation. The idea is to handle the complexity and uncertainties of disassembly tasks via effective interaction among different optimization models, digital twin models, AI-based decision-making modules, and the disassembly cell. In this paper, a conceptual framework is proposed to address the implications of lean practices in cobot disassembly cells based on the house of lean. The rest of the paper is organized as follows: Sect. 2 provides the literature review on collaborative robots in disassembly and lean practices in remanufacturing and disassembly. Section 3 explains the conceptual framework and finally, Sect. 4 includes the conclusion and perspective of future research.

## 2 Literature Review

### 2.1 Collaborative Robots in Disassembly

Today, the autonomous remanufacturing laboratory plays an essential role in an Industry 4.0-driven circular economy. Teixeira et al. (2022) performed a literature review on the opportunities for applications of industry 4.0 technologies in remanufacturing. The authors discussed the role of AR/VR, cobots, RFID, and IoT in (1) Guide used product disassembly; (2) Reduce variability in disassembly lead time; (3) Better estimation of product lifetime; (4) Customized diagnosis at the item level; (5) Additional support for the product recovery plan. They explained that AR and VR technologies could provide virtual instruction for end-of-life product evaluation [1]. Cobots provide semi-autonomous disassembly and can enhance the product remanufacturing performance considering the uncertainties and costs reduction. Huang et al. (2019) discussed the essential role of cobots in disassembly of repetitive, heavy and dangerous tasks for operators [2]. The precision and repeatability of the robots can combine with the skills of the operators for safe and efficient operation. Felder et al. (2019) discussed the role of cobot disassembly in critical material recovery. They explained that for the recovery of critical materials, applying cobots can lead to cost-efficiency and create flexibility in working cells. They developed a virtual collaborative robot cell for modeling cobots' movement for removing screws in the disassembly operations [3]. According to Tolio et al. (2017), there are several challenges for demanufacturing and remanufacturing systems including variant applications of the recovered parts, poor information in return products, increasing the complexity of products, and the uncertainties in the quality of the recovered parts, and more pressures for cost efficiencies [4]. Pham (2020) also discussed that the disassembly operations are stochastic in terms of the shapes and conditions of the used products [5]. The required flexibility manually and laboriously limits the aspect of automation and robotization in the disassembly context. However, there are great benefits of human-robot collaboration for better safety and efficient operation. Hjorth and Chrysostomou (2022) performed a literature review of studies in human-robot collaborative disassembling from 2009 to 2020 [6]. They discussed that fully automated disassembly tasks are mainly focused on consumers electronics considering the limited capacity of existing end-of-life sites for recycling and remanufacturing. However, disassembly of mechatronic and mechanical parts, considering the complexity of disassembly tasks, requires more flexible and customized operations. Hence, more studies focused

on cobots applications in this context. According to the authors, future research should focus on collaborative scenarios, more safe interaction among cobots and operators, and effective communications. Huang et al. (2020) discussed the case study of the disassembly of press-fitted components with cobots [7]. They concluded that cobots provide the opportunity for operators to work without the fence and decrease the installation costs, and there is no need to slow down the cobots or stop their work where operators are doing the tasks. Huang et al. (2021, 2019) also presented an experimental work cell for disassembly with cobots. They used two seven axes cobots with a payload of 14 kg for disassembling of an automotive turbocharger [2, 8]. They developed tasks allocation models for minimizing time and costs. However, the ergonomic factors could be integrated into the optimization of productivity as well as safety factors. The authors also mentioned the role of the digital twin in disassembly analysis, sequence planning, and simulation. Liu et al. (2019) developed a discrete bees algorithm for joint optimization of sequence planning and disassembly line balancing [17]. However, the authors assumed that the disassembly time of the parts is known. The uncertainties of disassembling operation could be integrated into these optimization models. Parsa and Saadat (2021) developed an optimization model with a genetic algorithm for the task allocation problem in cobot disassembly considering remanufacturing criteria [18]. The authors considered cleanability, repeatability, and economic conditions for selecting target tasks. Then they used the CAD model for mathematical representation of the target part and considered feasibility, constraints, and precedence in optimization tasks allocation between humans and robots. They used the case study of the fuel pump for showing the effectiveness of the proposed approach. Prioli and Rickli (2020) proposed an architecture and data model for automated disassembly [19]. The proposed UML comprises (1) part data including the geometry information, size, and weight, (2) cobot data includes trajectory, fasteners, and dimension, (3) line model includes the capacity, station, and output, (4) disassembly sequence optimizer as well as (5) disassembling characteristics. Several studies developed optimization models including discrete bees and genetic algorithms for disassembly sequence planning and task allocation. The uncertainties of disassembling operation could be integrated into these optimization models for future research. Considering the uncertainty of the part removal, the disassembly sequence optimization model will be a probabilistic planning model. The uncertainties should be addressed based on the product's characteristics, operators, cobots' operational parameters and the interaction between operator and robot.

Hence, the following gaps have existed in the literature of disassembly with cobots:

- Studying the tasks definition, task sharing, and tasks specific skills in addition to sequence planning
- Focusing on collaborative operations rather than cooperation and co-existence with cobots
- Developing the optimization approaches for productivity considering the safety and ergonomic factors under uncertainty.

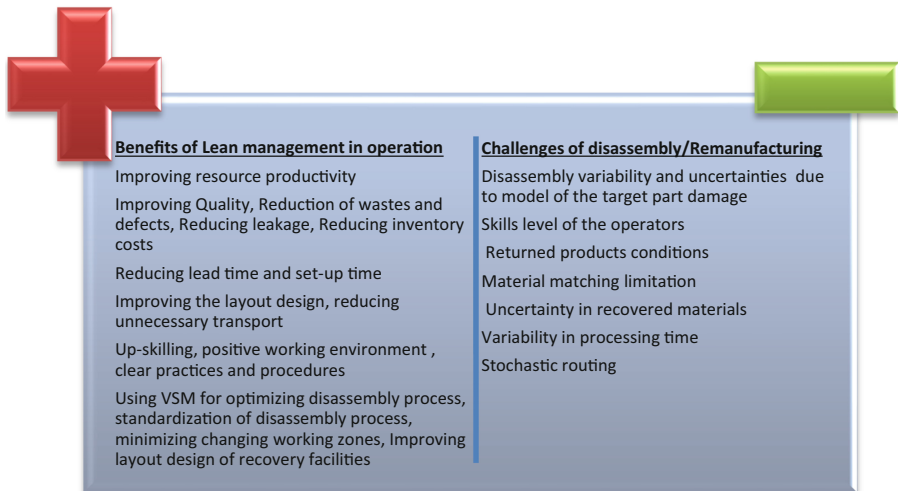
## 2.2 Lean Management in Disassembly

A few articles addressed the application of the lean approach to disassembly. Here a brief overview of how lean thinking could be integrated into disassembly processes is provided. Kanikuła and Koch (2009) proposed nine scenarios for integrating lean manufacturing practices into remanufacturing [9]. These main scenarios include using supermarkets for repaired parts, disassembly items, and pull systems. Dayi et al. (2016) discussed the lean principles in the disassembly of aircraft disassembly [10]. They suggested using Value Stream Mapping (VSM) for identifying the wastes and reducing the disassembly time by optimization of displacement in aircraft zones, developing an optimum disassembly sequence and pull system for integrating customers' demand in real-time.

Kurilova-Palisaitiene et al. (2018) discussed the application of the lean approach including, Kanban, standardized processes, continuous flow, teamwork, and suppliers' partnership in solving the remanufacturing challenges. They classified these challenges into three categories: process, system, and industry [11]. Hasibul et al. (2018) discussed the lean approach in car dismantling. They used VSM for addressing the improving opportunities of the dismantling process with lean [12]. Among testing, dismantling, cleaning, and inspection, dismantling takes 89% of the total time. It should be noted that 30% of this time is non-value added and wasted. Optimizing the layout and redesigning the work cell could reduce this time by 50%. The authors explained that the task time of disassembly is a variable parameter based on the model of the target part, damage, and the skills level of the operators. Kaizen process is applied to reduce the dismantling time with the training of workers and improving the workspace design. Golinska (2014) discussed the advantages of the lean approach in remanufacturing process [13]. The author concluded that the research in this area is at an early stage comparing the manufacturing process. She assessed the principles of Lean based on the challenges of remanufacturing process. For example, standardization is challenging due to the stochastic nature of the tasks. Pawlik et al. (2021) also developed a conceptual framework for the application of lean practices in remanufacturing [14]. They considered disassembly of returned products, material matching limitation, uncertainty in recovered material, variability in processing time, and stochastic routing as the challenges of remanufacturing. For the lean practices, they focused on standardized work instructions, standardization, Kanban, cross-function workforce, 5S, production analysis board, visual management, cellular manufacturing, and Total Productive Management (TPM). Most of the practices are applicable and can improve the high variable processing time of remanufacturing. Aicha et al. (2022) applied the 5S approach and Kaizen for optimizing the disassembly tasks of a gearbox [15]. Keivanpour (2022) discussed the application of lean management in the circular economy and the context of industry 4.0 [16]. A probabilistic simulation model is proposed to assess the interaction of lean, industry 4.0, and circular economy. Figure 1 summarizes the opportunities of lean practices in operation and the challenges of disassembly operation based on the literature review.

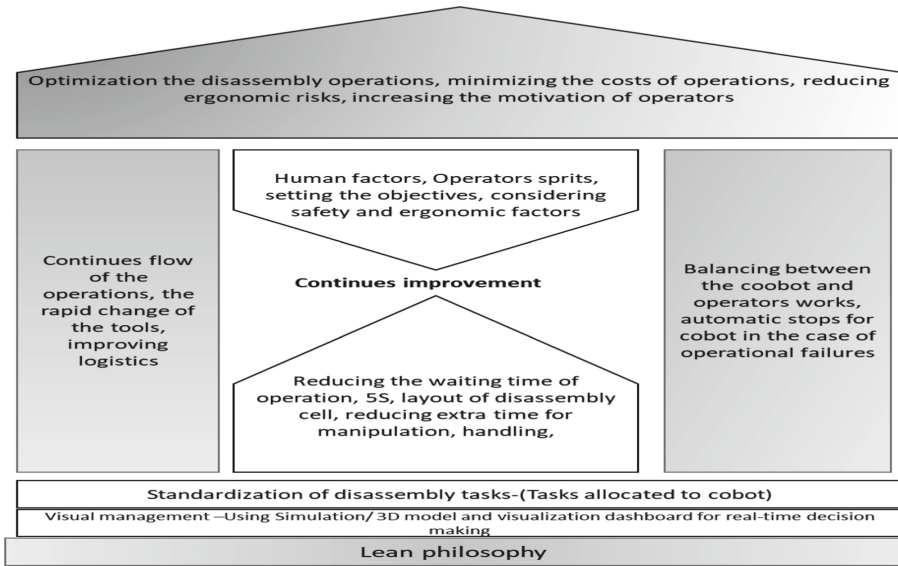
### 3 Conceptual Framework

The disassembly work cell includes a cobot, specific tools (for example grippers, screw-driver), machines for manual operation, an operator, a toolbox, parts collection boxes, target parts for disassembly, and a workbench. The disassembly cell design and workflow for operators and cobots are important elements in the efficiency of the disassembly operation. The first step of applying the lean philosophy is identifying the problems and root cause analysis.



**Fig. 1.** The opportunities of lean practices in the operation and the challenges of disassembly/remanufacturing

Figure 2 shows the fishbone diagram of a disassembly cell with a collaborative robot. The root causes are identified in six categories of people, process, equipment, measurement, environment, and management parameters. After identifying the sources of non-efficient operations, a problem-solving approach and process improvement should be applied to optimize the whole process. The conceptual framework for integrating lean philosophy into disassembly cells with cobot is illustrated in Fig. 3. The foundation of house of lean includes the standardization of the operational process and visual management. This standardization for the disassembly tasks assigned to the cobot could reduce the variability of the operator's tasks. A real-time decision dashboard can be designed for monitoring the process. The advanced simulation provides the mapping of the real-time interaction of robots and the operators to control the process and provide guidance and adjustments. This visual interface includes a 3D model, simulation, and disassembly sequence planning. It provides optimization/prediction, and results will be updated based on physical disassembly process feedback. For all designed experiments, it is essential to use a simulation platform and offline programming for testing and evaluating the operation scenarios outside of the production environment. The two foundations of the house of lean include guaranteeing the quality of the disassembly



**Fig. 2.** A lean approach to collaborative robot disassembly cell

process and continuous workflow. A robot control program could be adopted to consider automatic stops in the case of operational failures. Another strategy is reducing waste time for changing tools and designing the layout based on 5S principles (Sort, Set in Order, Shine, Standardize, Sustain) for improving the disassembly efficiency. A progress dynamic can be achieved by a problem-solving approach and by enhancing the motivation and spirits of the operators. Assigning heavy and repetitive work to cobots can reduce the safety and ergonomic risks and increase the operator’s productivity by focusing on more challenging manual tasks.

VSM is also an effective approach to creating a lean disassembly cell and optimizing the operational tasks. The outcomes will be reducing the disassembly total time, reducing ergonomic risks, and improving the collaboration between cobots, machines ad operators for the continuous flows. Figure 4 shows a VSM for disassembly of an automotive water pump by a collaborative robot based on the information provided in [2].

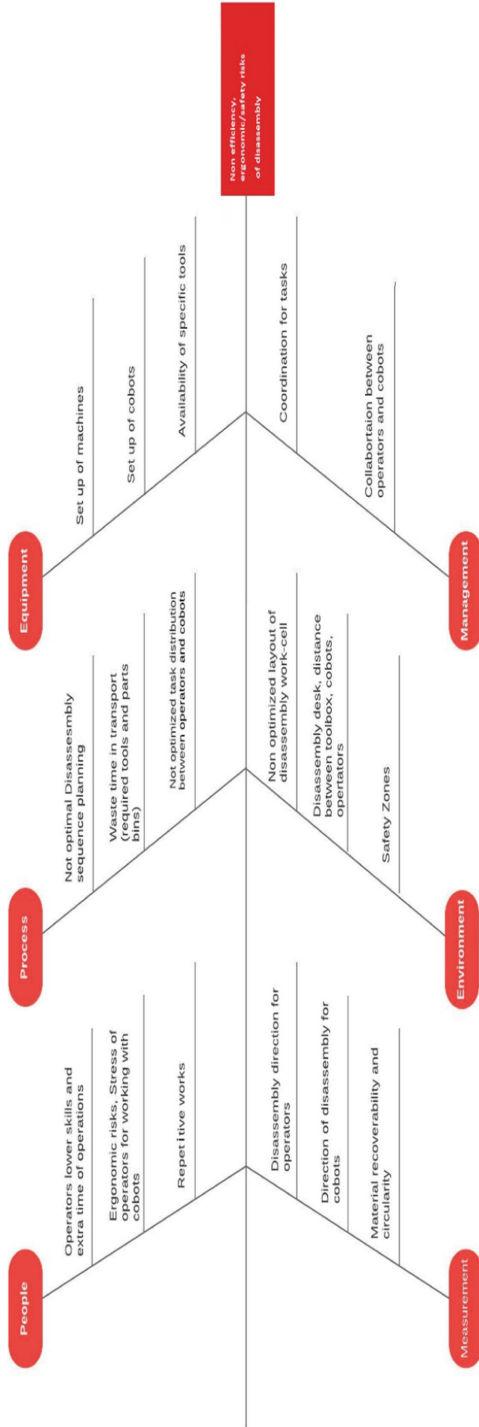


Fig. 3. Fishbone diagram for disassembly cell with cobot- Created in Lucidchart, [www.lucidchart.com](http://www.lucidchart.com)

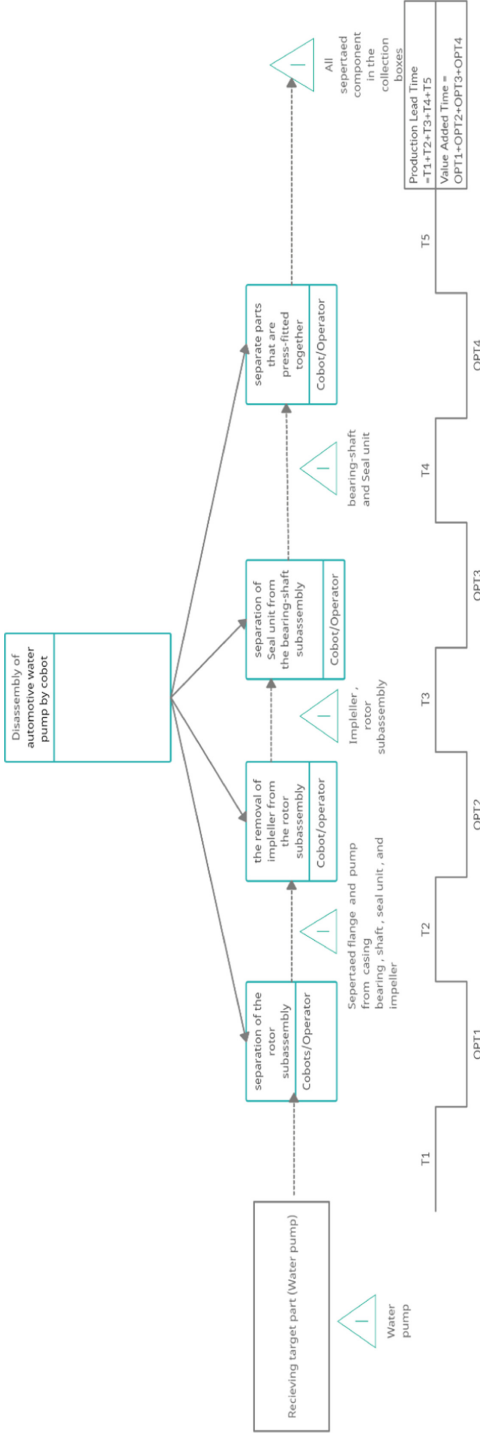


Fig. 4. A preliminary value stream mapping for disassembly of water pump based on the case study provided by Huang et al. [2]-Created in Creatly-[www.creatly.com](http://www.creatly.com)



## 4 Conclusion

Using collaborative robots in the remanufacturing and disassembly operation could enhance productivity, safety, and ergonomic conditions. This paper provided a brief literature review on the application of cobots in disassembly and the lean management approach in remanufacturing. A root cause analysis based on a fishbone diagram and a conceptual framework based on the house of lean for optimizing the operational tasks in disassembly cells is provided. As discussed, variability and uncertainty of the tasks are the main challenges of remanufacturing and disassembly. Integrating the uncertainty parameters in developing the optimization models for the sequence planning of the disassembly tasks is critical. Future research could focus on integrating the lean approach and optimization models for sequence planning of tasks under uncertainty. The other area for future research is using Ergonomic value stream mapping for optimizing the disassembly operation and improving the material circularity.

## References

1. Teixeira, E.L.S., Tjahjono, B., Beltran, M., Julião, J.: Demystifying the digital transition of remanufacturing: a systematic review of literature. *Comput. Ind.* **134**, 103567 (2022)
2. Huang, J., et al.: A strategy for human-robot collaboration in taking products apart for remanufacture. *Fme Trans.* **47**(4), 731–738 (2019)
3. Felder, B.: Programming of Collaborative Robot (Cobot) to Selectively Disassemble Products to Obtain Critical Materials (2019)
4. Tolio, T., et al.: Design, management and control of demanufacturing and remanufacturing systems. *CIRP Ann.* **66**(2), 585–609 (2017)
5. Pham, D.: AutoReman—the end of the beginning of robotic disassembly research?
6. Hjorth, S., Chrysostomou, D.: Human–robot collaboration in industrial environments: a literature review on non-destructive disassembly. *Robot. Comput.-Integr. Manufact.* **73**, 102208 (2022)
7. Huang, J., et al.: A case study in human–robot collaboration in the disassembly of press-fitted components. *Proc. Inst. Mech. Eng. Part B J. Eng. Manufact.* **234**, 654–664 (2020)
8. Huang, J., et al.: An experimental human-robot collaborative disassembly cell. *Comput. Ind. Eng.* **155**, 107189 (2021)
9. Kanikula, T., Koch, T.: Methodology of designing disassembly and reassembly processes using lean thinking approach. In: Vallespir, B., Alix, T. (eds.) *APMS 2009. IAICT*, vol. 338, pp. 11–18. Springer, Heidelberg (2010). [https://doi.org/10.1007/978-3-642-16358-6\\_2](https://doi.org/10.1007/978-3-642-16358-6_2)
10. Dayi, O., Afsharzadeh, A., Mascle, C.: A Lean based process planning for aircraft disassembly. *IFAC-PapersOnLine* **49**(2), 54–59 (2016)
11. Kurilova-Palisaitiene, J., Sundin, E., Poksinska, B.: Remanufacturing challenges and possible lean improvements. *J. Clean. Prod.* **172**, 3225–3236 (2018)
12. Hasibul, I.M., Gustav, B., Malin, T.: Adoption of lean philosophy in car dismantling companies in Sweden—a case study. *Procedia Manufact.* **25**, 620–627 (2018)
13. Golińska, P.: The lean approach for improvement of the sustainability of a remanufacturing process. *LogForum*, **10**(3) (2014)
14. Pawlik, E., Ijomah, W., Corney, J., Powell, D.: Exploring the application of lean best practices in remanufacturing: empirical insights into the benefits and barriers. *Sustainability* **14**(1), 149 (2021)

15. Aicha, M., Belhadj, I., Hammadi, M., Aifaoui, N. : A mathematical formulation for processing time computing in disassembly lines and its optimization. *Comput. Ind. Eng.* **165**, 107933 (2022)
16. Keivanpour, S.: Lean and industry 4.0 implication in circular design: an operational performance perspective. In: *Approaches, Opportunities, and Challenges for Eco-design 4.0*, pp. 55–66. Springer, Cham (2022). [https://doi.org/10.1007/978-3-030-87371-4\\_4](https://doi.org/10.1007/978-3-030-87371-4_4)
17. Liu, Q., Liu, Z., Xu, W., Tang, Q., Zhou, Z., Pham, D.T.: Human-robot collaboration in disassembly for sustainable manufacturing. *Int. J. Prod. Res.* **57**(12), 4027–4044 (2019)
18. Parsa, S., Saadat, M.: Human-robot collaboration disassembly planning for end-of-life product disassembly process. *Robot. Comput.-Integr. Manufact.* **71**, 102170 (2021)
19. Prioli, J.P.J., Rickli, J.L.: Collaborative robot based architecture to train flexible automated disassembly systems for critical materials. *Procedia Manufact.* **51**, 46–53 (2020)

**Open Access** This chapter is licensed under the terms of the Creative Commons Attribution 4.0 International License (<http://creativecommons.org/licenses/by/4.0/>), which permits use, sharing, adaptation, distribution and reproduction in any medium or format, as long as you give appropriate credit to the original author(s) and the source, provide a link to the Creative Commons license and indicate if changes were made.

The images or other third party material in this chapter are included in the chapter's Creative Commons license, unless indicated otherwise in a credit line to the material. If material is not included in the chapter's Creative Commons license and your intended use is not permitted by statutory regulation or exceeds the permitted use, you will need to obtain permission directly from the copyright holder.





# A Mathematical Model Considering Multi-skilled Operators and Industrial Robots on Reconfigurable Manufacturing Cells

Takayuki Kataoka<sup>(✉)</sup>

Kindai University, 1, Takaya-Umenobe, Higashi-Hiroshima 739-2116, Japan  
kataoka@hiro.kindai.ac.jp

**Abstract.** A sustainable reconfigurable manufacturing system is one of the most important topics concerning sustainability. Basically, the reconfigurable manufacturing systems have two streams. One is the machine-intensive and the other is the labour-intensive. The machine-intensive means a cell formation problem (CFP) or a reconfigurable manufacturing system (RMS). On the other hand, the labour-intensive means a cellular manufacturing (CM) or a Cell Production System (CPS). Almost all manufacturing sites have these assembly lines separately, however, some advanced manufacturing sites have adopted both CM and CPS in order to absorb variability of demand and operators under the environment of limited multi-skilled operators. When the operators are replaced by industrial robots in the real world, they are called robotic cells and focused as an important component of the cyber-physical system in the large number of recent papers. Therefore, this paper tackles to indicate a multi-period mixed integer programming model to solve simultaneously 2-type cell systems considering multi-skilled operators and industrial robots on reconfigurable manufacturing cells sustainably. Firstly, the traditional model is redefined by new parameters. Secondly, the proposed model is solved by 2-phase optimization problems. Finally, the proposed model is compared with the traditional model by using numerical experiments.

**Keywords:** Multi-Skilled Operators · Industrial Robots · Reconfigurable Manufacturing Cells

## 1 Introduction

A sustainable reconfigurable manufacturing system is one of the most important topics concerning sustainability. Basically, the reconfigurable manufacturing systems have two streams. One is the machine-intensive and the other is the labour-intensive. The machine-intensive means that the operator's role is usually limited to loading and unloading the machines and machining times usually do not vary from one operator to the next. In other words, operator involvement is limited to the machine-intensive as most of the processing is done by automated machines. On the other hand, in the labour-intensive, the assignment of operators plays a major role for the performance of the cell and directly

affects the output of the cell. Consequently, the cell performance is not only affected by how the cells are loaded, but also by the performance of the operators [1].

Furthermore, focusing on the approaches in the labour-intensive, there are two streams of concepts. One deals with the large volume production of a narrow variety of products and the other with the low volume production of a wide variety of products. In case of the large volume production of a narrow variety of products, the well-known traditional paced line deals with assembly line balancing problems [2] or sequencing problems [3] considering cycle time, work elements, and a precedence diagram on production planning. On the other hand, the low volume production of a wide variety of products has been one of the most important production concepts in the recent changeable demand and therefore in the global competition. Most of the research fields deal with paced or un-paced cells in labour-intensive cells where production rate, learning levels and team-work are based on human skill levels and human resource planning. Recent papers are mostly based on mixed integer and integer programming models regarding various divided cells on CM [1, 4–8].

On the other hand, theoretical models regarding CPS are also proposed by some previous papers [9, 10]. The models deal with CPS where a worker does all operational and managerial tasks by her- or himself. Such a Japanese CPS has been called “Seru” in Japan and other Asian countries. Seru, a new production organization, has been adopted by many leading global companies, such as Samsung, Sony, Canon, Panasonic, LG, and Fujitsu. Seru, i.e., CPS overcame a lot of disadvantages inherent in Toyota Production System (TPS) and brought amazing benefits to Seru users. For example: 1) Seru requires a much smaller workforce, 2) it can greatly reduce space requirements, and 3) it can reduce lead time, setup time, WIP inventories, finished-product inventories, and cost.

However, in general, almost all manufacturing sites have separately the assembly lines where one or several operators carry out parts/all of the operations in a cell. On the other hand, some advanced manufacturing sites have adopted both of them in order to absorb variability of demand and operators. In particular, the reconfigurable production lines with both of CM and CPS are more effective to absorb unstable demand and have been adopted by some global companies. That is the reason why the combinations of CM and CPS can lead more robust production system to overcome some constraints, i.e., the limited number of operators or limited multi-skilled operators. When the operators are replaced by robots in the real world, they are called robotic cells and focused as an important component of the cyber-physical system in the large number of recent papers [11–14]. Especially, both adaptive scheduling that enables near real-time cooperation among machines, workforce and the production manager and the optimization of the allocated operators-jobs correlation and the workforce cost as the model’s decision criteria should be considered [15, 16].

Therefore, the purpose of this paper is sustainably to propose a mathematical model to minimize the number of operators in the case of considering industrial robots on reconfigurable labour-intensive cells by solving not only CM but also CPS simultaneously. The new model is introduced in Sect. 2 and Sect. 3 presents some numerical experiments and results. The results of this paper are summarized in Sect. 4.

## 2 Modelling

The problem involves the following indices, variables, parameters, and decision variables.

Indices:	
$i$	index set of products ( $i=1,2,\dots,n$ )
$j$	index set of cells ( $j=1,2,\dots,m$ )
$k$	index set of configurations ( $k=1,2,\dots, a_j$ )
$o$	index set of operations ( $o=1,2,\dots,s$ )
Variables:	
$p_{ijk}$	the time required to produce product $i$ in cell $j$ with configuration $k$
Parameters:	
$n$	the number of products
$m$	the total number of cells
$a_j$	the number of alternative configurations for cell $j$
$s$	the number of operations
$u_{io}$	the upper limit for operator level for operation $o$ of product $i$
$t_{io}$	the unit standard time (standard operation time) for operation $o$ of product $i$
$w_{jk}$	the total operators available in the cell $j$ with configuration $k$
$RB_{max}$	the maximum number of robots
$RB_{up}$	the production efficiency of robots
$h$	the time available in a period
$m'$	the number of cells on CM
$d_i$	the demand of product $i$
$b_{jk}$	the manpower required for configuration $k$ in cell $j$
Decision variables:	
$R_{ik}$	the production rate for product $i$ with configuration $k$
$M_{iko}$	the operator level for operation $o$ of product $i$ with configuration $k$
$G_o$	the number of robots for operation $o$
$X_{ijk}$	the product $i$ assigned to cell $j$ with configuration $k$
$Y_{jk}$	the alternative configuration $k$ for cell $j$

The object of this paper is to build the deterministic reconfigurable production modeling with both CM and CPS in the case of considering industrial robots. The first object is to determine optimal operator levels and loads in each cell. Next, products are assigned to cells and the operator level for each cell is also determined. The  $p_{ijk}$  value on CM is obtained by dividing the demand of product  $i$  ( $d_i$ ) by the production rate for product  $i$  with configuration  $k$  ( $R_{ik}$ ) based on the previous model, and the  $p_{ijk}$  value on CPS is obtained by dividing the demand of product  $i$  ( $d_i$ ) by the production rate for product  $i$  with configuration  $k$  based on the proposed model. Finally, the  $p_{ijk}$  values are obtained by the following Eq. (1). The  $m'$  value is the number of cells on CM. The  $m$  value is the

total number of CM and CPS.

$$p_{ijk} = \begin{cases} \frac{d_i}{R_{ik}}, & j = 1, 2, \dots, m' \\ \frac{d_i}{\left(\sum_{o=1}^s \frac{1}{t_{io}}\right) * b_{jk}}, & j = m' + 1, \dots, m \quad \forall i, k \end{cases} \quad (1)$$

(Phase 1)

The objective is to determine the optimal allocation of operators and industrial robots to operations such that the output rate is maximized for a given operator level based on the previous model [1]. The output rate is determined based on the bottleneck operation. Alternative operator levels are generated for each product by using operation standard times. For each operator level, the number of operators needed to perform the operation is determined by using this model.

The objective function maximizes the output rate as given in Eq. (2). Equation (3) and (4) guarantees that each operation is assigned enough operators and industrial robots to accomplish the maximum output rate. Equation (5) establishes the upper limit on the number of operators for each operation, whereas Eq. (6) gives the restriction on the total number of operators.

Objective function:

$$Z_1 = \text{Max}(R_{ik}) \quad (2)$$

Subject to:

$$\left(\frac{M_{iko} + RB_{up} * G_o}{t_{io}}\right) - R_{ik} \geq 0 \quad \forall i, k, o \quad (3)$$

$$\sum_{o=1}^s G_o \leq RB_{max} \quad \forall o \quad (4)$$

$$M_{iko} \leq u_{io} \quad \forall i, k, o \quad (5)$$

$$\sum_{o=1}^s M_{iko} \leq w_{jk} \quad \forall i, j, k \quad (6)$$

$M_{iko}$  integer and positive  $\forall i, k, o$

$G_o$  binary/integer and positive  $\forall o$

$R_{ik}$  real and positive  $\forall i, k$

(Phase 2)

The objective function minimizes the total number of operators and the total time required to produce all products as given in Eq. (7). Each product must be assigned to a cell as shown in Eq. (8). Equation (9) guarantees that each cell will have at most one configuration (i.e., operator level). Equation (10) establishes the upper limit on available capacity in each cell.

Objective function:

$$Z_2 = \text{Min} \left\{ \sum_{j=1}^m \sum_{k=1}^{a_j} b_{jk} * Y_{jk} + \left( \sum_{i=1}^n \sum_{j=1}^m \sum_{k=1}^{a_j} p_{ijk} * X_{ijk} \right) / (h * m) \right\} \quad (7)$$

Subject to:

$$\sum_{j=1}^m \sum_{k=1}^{a_j} X_{ijk} = 1 \quad \forall i \quad (8)$$

$$\sum_{k=1}^{a_j} Y_{jk} \leq 1 \quad \forall j \quad (9)$$

$$\sum_{i=1}^n (p_{ijk} * X_{ijk}) \leq h * Y_{jk} \quad \forall j, k \quad (10)$$

$X_{ijk}$  real and positive  $\forall i, j, k$

$$Y_{jk} \in \{0, 1\} \quad \forall j, k$$

### 3 Experiments

In the experiments, the manufacturing process consists of 5 operations and 10 products. The standard times for operations 1, 2, 3, 4 and 5 are randomly generated from uniform distributions in the intervals of [0.04, 0.09], [0.28, 0.45], [0.37, 1.18], [0.47, 0.88] and [0.18, 0.45], respectively. 10 alternative operator levels are considered, namely [10...19] on CM and [1...10] on CPS, respectively. Unit transfer size is assumed and the output rate is determined based on the bottleneck operation [1].

The optimal production rate for product  $i$  with configuration  $k$  on CM is calculated as shown in Phase 1. Furthermore, the output rate ( $1 / \sum_{o=1}^S t_{io}$ ) for product  $i$  on CPS in the case of a one-worker rotating cell is constant regardless of operator skills. Consequently, the production rate ( $(1 / \sum_{o=1}^S t_{io}) * b_{jk}$ ) for product  $i$  with configuration  $k$  on CPS is calculated as shown in Eq. (1).

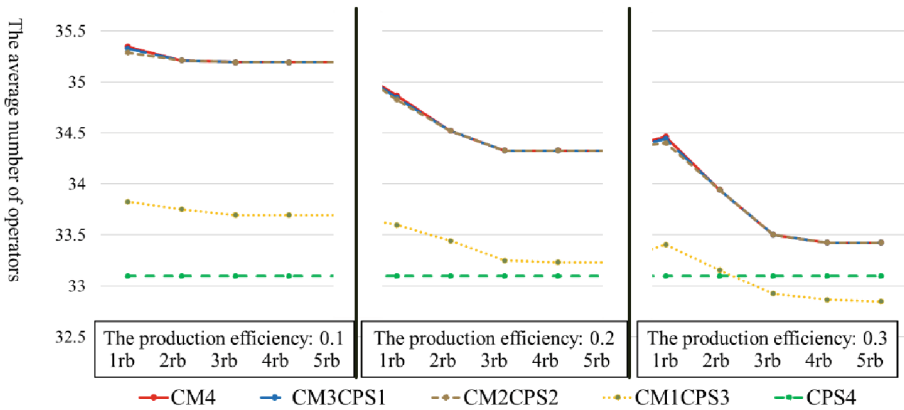
In the experiments, we use the demand of multi-period (:52 weeks, i.e., 1 year) for two scenarios. The mean period demand for product  $i$  is randomly generated from uniform distribution in the interval of [2200, 7500]. Then, the period demand is summarized for each period. The variation in period demand is ( $\pm 2\%$  - $20\%$ ) of the mean and in multiples of 50 units [1]. The value of  $h$  is set to the constant (2,400) during the experiment. The maximum number of robots is 5 and the production efficiency of robots is 0.1, 0.2, or 0.3. To find out the combinations of CM and CPS that can lead more robust production system, 5 combinations are considered.

*(Scenario 1/ $G_0$  is binary)*

The production rate considering whether one robot or not for each operation within the maximum number of robots is calculated when  $G_0$  is binary. As a result, the number of operators is decreasing when the production efficiency of robots is increasing except for CPS4. However, the cost performance is worse in the case of more than 4 robots. The combinations of CM4, CM3CPS1, CM2CPS2 lead the same results by selecting CM2 basically to minimize the total number of operators. That is the reason why the lines for them coincide (Fig. 1).

*(Scenario 2/ $G_0$  is integer and positive)*

The production rate considering multi robots, one robot, or not for each operation within the maximum number of robots is calculated when  $G_0$  is integer and positive. As a result, the number of operators is decreasing when the production efficiency of robots is increasing except for CPS4. Additionally, the cost performance is also not worse in the case of more than 4 robots. The combinations of CM4, CM3CPS1, CM2CPS2 lead the same results by selecting CM2 basically to minimize the total number of operators. That is the reason why the lines for them coincide (Fig. 2).



**Fig. 1.** The results of experiments ( $G_0$  : binary)



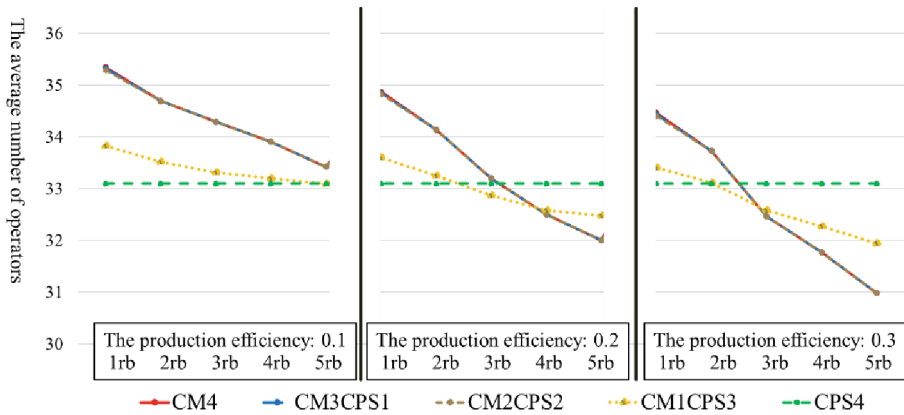


Fig. 2. The results of experiments ( $G_o$  : integer and positive)

## 4 Conclusion

The traditional model to minimize the total number of operators in labour-intensive cells has some shortcomings. To overcome them, a multi-period mixed integer programming model with 2-type cell production systems in the case of considering industrial robots was proposed in this paper. Firstly, the traditional model was redefined by new production rates. Secondly, the proposed model was solved by 2-phase optimization problems. Furthermore, the proposed model was compared with two scenarios by using numerical experiments. As a result, this paper showed better cases in which the proposed model could lead to fewer operators in the case of considering industrial robots. However, they are considered only in toy problems.

In future, we would like to solve the large-scale problems and propose a multi-period mixed integer programming model without phases on reconfigurable production systems. In addition, we would like to discuss the cost of reconfiguration (e.g. one-time costs, regular costs per change) as further optimization criteria.

**Acknowledgements.** This work was supported by JSPS KAKENHI Grant Number 20H02390 and 20K04993.

## References

1. Stier, G.A., Tummaluri, R.R.: Multi-period operator assignment considering skills, learning and forgetting in labour-intensive cells. *Int. J. Prod. Res.* **46**(2), 469–493 (2008)
2. Becker, C., Scholl, A.: A survey on problems and methods in generalized assembly line balancing. *Eur. J. Oper. Res.* **168**, 694–715 (2006)
3. Boysen, N., Flidner, M., Scholl, A.: Sequencing mixed-model assembly lines: survey, classification and model critique. *Eur. J. Oper. Res.* **192**, 349–373 (2009)

4. McDonalda, T., Ellis, K.P., Van Aken, E.M., Koelling, C.P.: Development and application of a worker assignment model to evaluate a lean manufacturing cell. *Int. J. Prod. Res.* **47**(9), 2427–2447 (2009)
5. Süer, G.A., Alhawari, O.: Operator assignment decisions in a highly dynamic cellular environment. *Oper. Manag. Res. Cell. Manufact. Syst.* 258–276 (2012)
6. Süer, G.A., Kamat, K., Mese, E., Huang, J.: Minimizing total tardiness subject to manpower restriction in labor-intensive manufacturing cells. *Math. Comput. Model.* **57**(3–4), 741–753 (2013)
7. Egilmez, G., Süer, G.A.: The impact of risk on the integrated cellular design and control. *Int. J. Prod. Res.* **52**(5), 1–24 (2013)
8. Egilmez, G., Erenay, B., Süer, G.A.: Stochastic skill-based manpower allocation in a cellular manufacturing system. *J. Manuf. Syst.* **33**, 578–588 (2014)
9. Kaku, I., Gong, J., Tang, J., Yin, Y.: A mathematical model for converting conveyor assembly line to cellular manufacturing. *Int. J. Ind. Eng. Manag. Sci.* **7**(2), 160–170 (2008)
10. Kaku, I., Gong, J., Tang, J., Yin, Y.: Modeling and numerical analysis of line-cell conversion problems. *Int. J. Prod. Res.* **47**(8), 2055–2078 (2009)
11. Yildiz, S., Akturk, M.S., Karasan, O.E.: Bicriteria robotic cell scheduling with controllable processing times. *Int. J. Prod. Res.* **49**(2), 569–583 (2011)
12. Kusiak, A.: Smart manufacturing. *Int. J. Prod. Res.* **56**(1–2), 508–517 (2018)
13. Sriskandarajah, C., Shetty, B.: A review of recent theoretical development in scheduling dual-gripper robotic cells. *Int. J. Prod. Res.* **56**(1–2), 817–847 (2018)
14. Kataoka, T.: A multi-period mixed integer programming model on reconfigurable manufacturing cells. *Procedia Manufact.* **43**, 231–238 (2020)
15. Mourtzis, D., Siatras, V., Synodinos, G., Angelopoulos, J., Panopoulos, N.: A framework for adaptive scheduling in cellular manufacturing systems. *Procedia CIRP* **93**, 989–994 (2020)
16. Mourtzis, D., Siatras, V., Angelopoulos, J., Panopoulos, N.: An intelligent model for workforce allocation taking into consideration the operator skills. *Procedia CIRP* **97**, 196–201 (2021)

**Open Access** This chapter is licensed under the terms of the Creative Commons Attribution 4.0 International License (<http://creativecommons.org/licenses/by/4.0/>), which permits use, sharing, adaptation, distribution and reproduction in any medium or format, as long as you give appropriate credit to the original author(s) and the source, provide a link to the Creative Commons license and indicate if changes were made.

The images or other third party material in this chapter are included in the chapter's Creative Commons license, unless indicated otherwise in a credit line to the material. If material is not included in the chapter's Creative Commons license and your intended use is not permitted by statutory regulation or exceeds the permitted use, you will need to obtain permission directly from the copyright holder.





# 5S Implementation to Minimize Waste in Bread Production Process (Case Study: Madani Bakery)

Nilda Tri Putri<sup>(✉)</sup> , Dicky Fatrias , and Santa Rosa Roberta Simbolon

Universitas Andalas, Padang, Indonesia  
nildatp@eng.unand.ac.id

**Abstract.** This paper aimed to implement the 5S concept at Madani Bakery by using PDCA (Plan, Do, Check, and Action) to reduce waste. The problems found in the bread industry have not implemented 5S so that there is waste during production activities. The method that can be used to overcome these problems is to apply 5S and PDCA so that they can make continuous improvements. The initial data used is the result of observing the initial conditions before implementing 5S and then determining Plan, Do, Check, and Action (PDCA). Based on observations at Madani bakery, two types of waste were found, namely unnecessary motion and transportation. Madani Bakery has not yet fully implemented 5S, there is still dust, items are in random condition, and there are still unused items at the work station. 5S deployments are designed to improve workstations and reduce unnecessary waste movement and transportation. The limitation of this research is that the application of 5S is carried out according to the conditions of the production area at Madani Bakery. This research can be useful for Madani Bakery to create a comfortable work environment and reduce working time caused by waste during production activities. This research is expected to help Madani Bakery to implement 5S so that it becomes a work culture to reduce waste. Repairs to work stations at Madani Bakery can be used in other industries in implementing 5S and creating a work culture. Working time was cut to 784.34 min, and waste was cut to 11.773 min.

**Keywords:** 5S · Waste · PDCA

## 1 Introduction

The economic success of a country can be seen from its level of economic growth which is indicated by the value of the Gross Regional Domestic Product (GDP). The processing industry in various fields in Agam Regency, West Sumatra based on data from the Central Statistics Agency (BPS) is in the eleventh position. One of the production areas of the food industry is bread. Bread consumption in Agam Regency, West Sumatra has increased based on data from the Indonesian Central Statistics Agency (BPS). The challenge faced by Madani Bakery is the growing development of the white and sweet

bread industry in Agam, West Sumatra. There are similar businesses that produce bread with various flavors.

5S is a method used to make improvements with the aim of increasing system performance, increasing productivity, reducing the time required to add value, and improving products quality [2]. The benefits of implementing 5S are reducing the activity of looking for goods, reducing waste, reducing the possibility of work accidents, reducing costs downtime, and better space utilization. The implementation of 5S can be carried out by all employees regardless of their education so that they can be an organized workplace, create a clean work environment, increase safety, and be able to perform continuous improvement of work stations [1]. The PDCA or Deming Cycle method is a method used to make continuous improvement with future orientation, flexibility, and logic. There are four phases used in this method, namely planning, implementation, testing, and implementation. The PDCA cycle is carried out for corrective, temporary, and permanent repairs to eliminate the root cause and fix the problem [4]. A plan is a strategic plan for achieving the targeted results, do is carry out a plan or target, check is an inspection condition before and after repair, and action is taken to standardize or fix problems [6].

## 2 Method

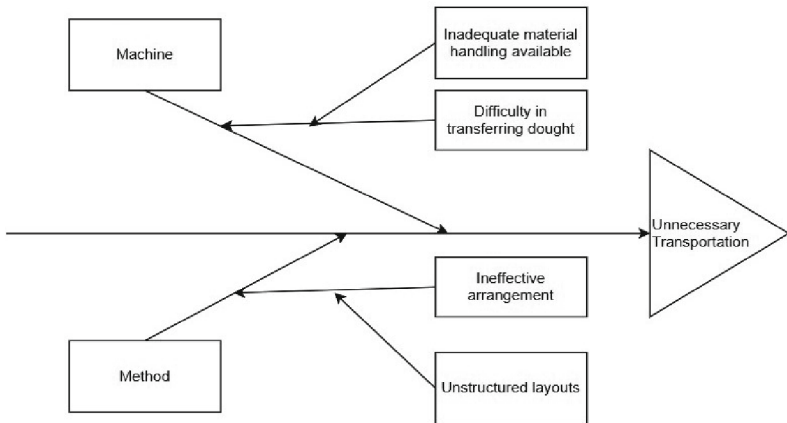
The 5S method according to Houa for creating a comfortable work environment, set standards, and make continuous improvements so that through the 5S methodology, management can create an environment where quality work is comfortable, clean, and safe in the organization and can optimize productivity by continuously maintaining systems in the workplace consistently [3]. The methods used are PDCA (Plan, Do, Check, and Action) and 5S. The 5S method is used to make repairs to the work station at Madani Bakery.

The 5S and PDCA methods were used. According to Houa, 5S is used to create a comfortable work environment, set standards, and improve continuously. The 5S methodology can be used to create a quality work environment that is comfortable, clean, and safe in the organization, as well as to continuously optimize productivity [3]. To identify goals, problems, and targets, the PDCA method is used. Madani Bakery has officially approved that their name will be published because Madani Bakery has improved its work culture and wants to serve as a model for other businesses.

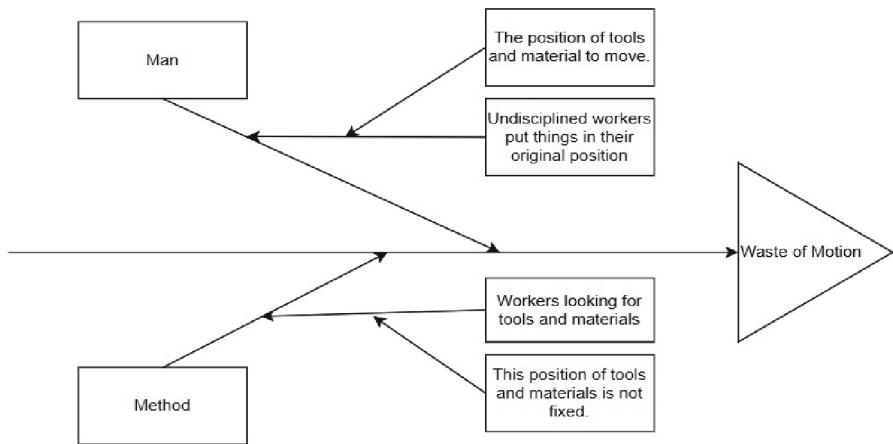
## 3 Results and Discussion

Implementation at this stage, workstation documentation is carried out to identify problems that exist in Madani Bakery. Data collection of equipment used in bread production.

Plan to design improvements to reduce waste. The tools used are fishbone diagrams to identify the causes of waste. Identifying problems and designing solutions to be implemented. Fishbone diagram for transportation waste (see Fig. 1. Fishbone diagram for transportation waste) and fishbone diagram for motion waste (see Fig. 2).



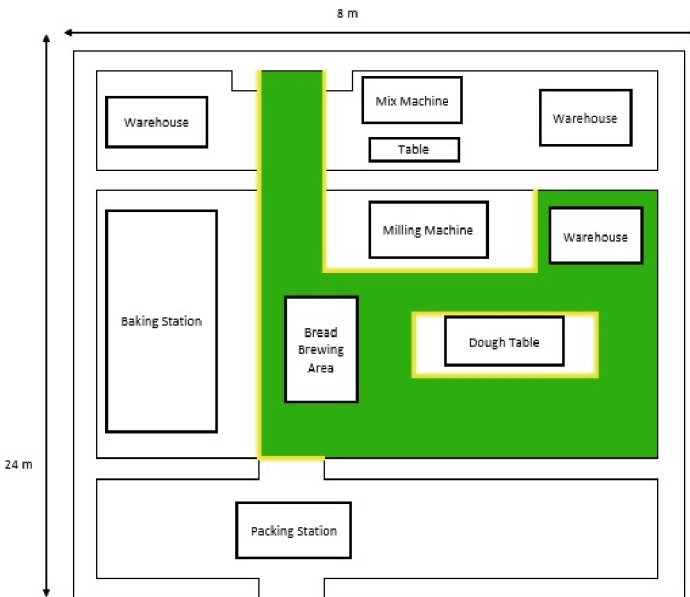
**Fig. 1.** Fishbone diagram for transportation waste



**Fig. 2.** Fishbone diagram for motion waste

Do is done to carry out repairs to the work area at Madani Bakery. Improvements were made by implementing 5S consisting of Seiri, Seiton, Seiso, Seiketsu, and Shitsuke. The goods are sorted at the work station during the Seiri or concise stage. The sorting policy is designed to determine the frequency of use of each item. Items that are used frequently or on a daily, weekly, or hourly basis are located near work stations. The goods are divided into several categories at the Seiton stage to make storage easier to determine. Each work station is given a boundary line at the Seiton stage. The boundary line is used to determine whether or not the work station is tidy. If the goods are damaged, they will be repaired (see Fig. 3). Seiso stage was cleaning equipment in the form of a waste basket is provided. Garbage bags are being replaced with baskets because they are more convenient to use. Other cleaning tools are adequate, but there is currently no storage space. As a result, the tool is placed arbitrarily. The work area is disorganized as

a result of this condition. The provision of hangers' aids in the organization of cleaning supplies. Hangers are strategically placed near the printing workstation.



**Fig. 3.** Layout and painting strategy at madani bakery

The Seiketsu stage is carried out by making 5S reminder displays and work instructions can be seen in Table 1. Shitsuke was carried out by making a 5S audit checklist and socializing 5S. Shitsuke is done by introducing 5S to workers at Madani Bakery. The introduction of 5S was carried out by providing material related to the history of 5S, the meaning of 5S, and forms of application of 5S in the industry. Workers who are still unsure about the 5S explanation can ask questions. Audits can be carried out directly by business owners or workers who understand field conditions. Before the audit, the auditor will be explained the audit process and fill out the checklist.

Workers are disciplined to implement 5S at the Shitsuke stage. Before attempting to build worker discipline, 5S is introduced to workers. The introduction of 5S is carried out by conducting training to ensure that all employees share the same perspective on the importance of 5S. A trainer is present to conduct the training.

The process flow map after 5S implementation shows the operating and transportation times are 773.89 and 10.49 min, respectively. The total activity after the implementation of 5S is 784.38 min. Comparison with the previous production time shows a reduction in the production time of 4.57 min. The process flow map after 5S implementation shows the operating and transportation times are 773.89 and 10.49 min, respectively. The total activity after the implementation of 5S is 784.38 min. Comparison with the previous production time shows a reduction in the production time of 4.57 min. Standardization in production activities is shown in Table 2.

**Table 1.** Bread making work instruction.

<b>Bread Production Work Instructions at Madani Bakery</b>		
Verified By	: <i>Staff</i> Production	
Approved By	: Leader	
<b>I. Raw Material Preparation</b>		
<b>Tools and materials</b>	<b>Work Order</b>	<b>Person in Charge of</b>
Tools: Scales, bowl, knife, and dipper.	1. Prepare the equipment used when taking materials.	Operator 1
Ingredients: 15 kg of flour, 2.6 kg of sugar, 7 eggs, 600 grams of butter, 900 grams of margarine, 100 grams of vegetable emulsifier, 150 grams of salt, and 180 grams of yeast.	2. Take all the ingredients to make the dough. 3. Weigh all ingredients with a predetermined composition. 4. The material is laid out on the table at the milling workstation. 5. Prepare the tools to be used at the first workstation.	
<b>II. Making Dough</b>		
Equipment: Mixer machine, bowl, and dipper. Ingredients: Wheat flour, water, sugar, salt, margarine, vegetable emulsifier, and yeast.	1. Take and put the material into the milling machine. 2. Turn on the engine for 3 minutes. 3. Turn off the machine and put it in the basin.	Operator 1
<b>III. Flattening of Dough</b>		
Equipment: Milling Machine and Basin. Ingredients: Dough	1. Put the dough into the grinding machine. 2. Turn the grinding machine until it becomes flat. 3. The flat dough is put into a basin.	Operator 1
<b>IV. Dough Printing</b>		
Tools: Scales, <i>roll</i> dough <i>steel scraper</i> , baking sheet, ceramic mat, and basin. Ingredients: Dough.	1. Divide the dough into several parts with a <i>steel scraper</i> . 2. Flatten the dough with a <i>roll</i> using a ceramic base. 3. Form the dough and put it in the pan. 4. Arrange the baking sheet on the expansion area covered with plastic and let it rest for 4 hours.	Operator 1-7
<b>V. Baking Dough</b>		
Tools: Bowl, brush, breadboard, and toaster. Ingredients: Dough, butter	1. Spread butter on the dough that has been formed. 2. Put the dough into the toaster. 3. Bake the dough for 30 minutes. 4. After the dough is cooked, transfer it to the breadboard.	Operator 1

(continued)

**Table 1.** (continued)

<b>VI. Raw Material Preparation</b>	
Tools: breadboard, packaging plastic, cardboard, bread rack, fan, and <i>hand sealer</i> .  Ingredients: Bread.	<ol style="list-style-type: none"> <li>1. Cool the bread using a fan for 3 hours.</li> <li>2. Transfer the bread to a rack to let it rest for 2 hours.</li> <li>3. Remove the bread from the storage rack.</li> <li>4. Pack the bread with plastic packaging and label the price with a <i>hand sealer</i>.</li> <li>5. Put the bread into the cardboard.</li> </ol>

Operator  
1-7

**Table 2.** Standardization of production activities at madani bakery.

No.	Factor	Normal Standard	Company Standard After Repair
1	Operator	Workers must be disciplined in attending and following the training that will be carried out at Madani Bakery	Workers must be disciplined in placing goods according to a predetermined place
		Workers must be disciplined in placing goods according to a predetermined place	The head of the production can carry out surprise supervision on workstations
2	Machinery or Equipment	Material handling is available in sufficient quantities	The head of the production collects material handling data
3	Method	Effective work station layout design	Improvements to the workstation layout
		Determine the standard of storage of goods	Provide direction to workers in the placement of goods and the implementation of 5S

## 4 Conclusion and Recommendation

This study concludes that 5S was implemented at Madani Bakery by sort goods and red tags for the Seiri stage. At the Seiton stage, storage containers, item name labels, and borders are carried out. Seiso is done by providing hygiene kits and hygiene schedules. The Seiketsu stage is performed with the creation of a 5S reminder display and work instructions. Shitsuke was done by making checklist audit 5S and socialization 5S. Madani Bakery requires discipline in carrying out 5S because this is something new for workers. There was a reduction in waste from a total waste time of 12.46 min to 11,773 min. Waste reduction occurs because the goods at the workstation are neatly arranged so that it is easier to find and the existence of work instructions makes every worker have



the same workflow. The advice that can be given to Madani Bakery is monitoring the implementation of 5S regularly with 5S audits and repairs if discrepancies are found at work stations so that 5S can become a work culture of Madani Bakery.

**Acknowledgments.** The authors would like to thank the Department of Industrial Engineering, Faculty of Engineering, Universitas Andalas for providing publication grant 2022.

## References

1. Chourasia, R., Nema, A.: Implementation of 5S methodology in higher education institute. *Int. Res. J. Eng. Technol.* **6**(2), 1795–1799 (2019)
2. COSTA, C.: Implementation of 5S Methodology in a Metalworking Company. *Daaam International Scientific* 1–12 (2018)
3. Houa, S.: Implementation of 5S in manufacturing industry: a case of foreign workers in Melaka. In: MUCET, pp. 1–5 (2018)
4. Isniah, S.: Plan do check action (PDCA) method: literature review and research issues. *J. Ind. Syst. Manag.* **4**(1), 72–81 (2020)
5. Patel, P., dan Deshpande, V.: Application of plan-do-check-act cycle for quality and productivity improvement. *Int. J. Res. Appl. Sci. Eng. Technol.* **5**(1), 197–201 (2017)
6. Taufik, D.: PDCA Cycle method implementation in industries: a systematic literature review. *Indonesian J. Ind. Eng. Manag.* **1**(3), 157–166 (2020)

**Open Access** This chapter is licensed under the terms of the Creative Commons Attribution 4.0 International License (<http://creativecommons.org/licenses/by/4.0/>), which permits use, sharing, adaptation, distribution and reproduction in any medium or format, as long as you give appropriate credit to the original author(s) and the source, provide a link to the Creative Commons license and indicate if changes were made.

The images or other third party material in this chapter are included in the chapter's Creative Commons license, unless indicated otherwise in a credit line to the material. If material is not included in the chapter's Creative Commons license and your intended use is not permitted by statutory regulation or exceeds the permitted use, you will need to obtain permission directly from the copyright holder.





# Environmental Assessment and Optimization When Machining with Micro-textured Cutting Tools

Amr Salem<sup>1</sup>(✉), Hussien Hegab<sup>1,2</sup>, and Hossam A. Kishawy<sup>1</sup>

<sup>1</sup> Machining Research Laboratory, Ontario Tech University, Oshawa, Canada  
Amr.Salem1@ontanriotechu.net

<sup>2</sup> Currently at Mechanical and Aerospace Engineering Department, United Arab Emirates  
University (USAEU), Al Ain, Abu Dhabi, UAE

**Abstract.** The dry machining strategy has recently received high attention in the field of metal cutting as it can eliminate the environmental impacts associated with the usage of cutting fluids. However, high-generated heat and severe tool wear are usually observed for the dry machining operations. One of the suggested techniques to improve the dry machining performance is to utilize the textured cutting tools, reducing the friction at the chip-tool interface. In this study, three different micro-textured tool designs were used during the machining AISI 1045 at different cutting conditions. A life cycle assessment was performed including the power consumption for preparing the textured tool designs and the measured power during the machining experiments. Furthermore, some measured machining outputs (flank wear, surface roughness, and the unit volume machining time) were further included to offer a comprehensive and effective sustainability assessment for the performance of the utilized textured tools. The performance of these textured tools was also compared with the non-textured tool under the same cutting conditions. The textured tool design with narrow micro-groove width showed better sustainable performance compared to the non-textured tool and other textured tool designs.

**Keywords:** Textured cutting tools · Machining · Life Cycle Assessment · Sustainability · Performance Analysis · Optimization

## 1 Introduction

The manufacturing sector is targeted to satisfy sustainability requirements. This is due to the high energy consumption and high carbon dioxide emissions from this sector. As the machining processes are representing 5% of the Gross Domestic Product (GDP) in developed countries [1], there is a need to apply sustainability principles within all the machining processes. There is recently more demand to adopt the concept of dry machining as it is one of the eco-friendly strategies. Besides, there are many research works focused on cutting tool surface texturing to overcome the drawbacks of dry machining. Based on the literature, it was found that the textured cutting tool has a big contribution

to enhance the dry machining performance. However, additional cutting of the bottom side of the chip has been found when using the textured tools. This micro-cutting of the bottom side of the chip by the micro-grooves edges is defined as “Derivative cutting phenomena” [2]. This cuts down the benefits of using textured tools. The dimensions of the micro-grooves play a crucial role in the performance of the textured cutting tool, especially on the derivative cutting phenomena. These dimensions are position, width, and the radius of the micro-grooves edge [3, 4]. A lot of research works have been performed to accurately assess the sustainable performance of the machining processes [5–9]. However, implementation of the sustainability assessments which considered the sustainability principles, as well as the machined surface integrity aspects, needs to be widely applied to machining using textured cutting tools. As different designs of textured tools have different machining performances, this is still a need to evaluate the environmental and human health impacts of machining using different designs of textured cutting tools. Besides, a holistic performance analysis of different designs of textured cutting tools and non-textured cutting tools based on performed experimental results is yet to be conducted. Accordingly, this study is focused on optimizing the sustainable performance of the machining using textured and non-textured tools in a way considers the existing sustainable machining elements, life cycle assessment impacts, and the quality of the machined product. Furthermore, the obtained optimized cutting conditions were then processed through non-dominated sorting to obtain the superiority of the studied strategy.

## 2 Experimentation

The machining experiments studied the effect of the significant textured dimension parameter (micro-groove width) with different machining parameters (i.e., cutting speed and feed). Table 1 shows the cutting speeds ( $V_c$ ) and feed ( $f$ ) used in these experiments with non-textured and three textured tool designs. The used textured tool designs include different values of the micro-groove width ( $l$ ), one of the most significant micro-groove geometrical parameters [2, 10], to investigate their effects on the machining outputs (i.e., power consumption ( $W$ ), flank tool wear ( $VB$ ), surface roughness ( $R_a$ ), and unit volume machining time ( $T$ )). As shown in Fig. 1, the three texture designs have different groove widths, spacing between grooves, and number of grooves, while for all designs, the distance from the cutting edge to the first groove is  $240\ \mu\text{m}$ , the spacing of the total grooves is  $90\ \mu\text{m}$ , and the total width of all micro-grooves is  $180\ \mu\text{m}$ . The uncoated mixed ceramic insert (TNGA332T0320 650) and tool holder (DTG NR 2525M 16) were used in the experimentation phase. YDFLP system was used to generate micro-grooves on the rake faces of the cutting inserts. These orthogonal cutting experiments were done on a 30-mm-diameter and 1-mm-thick AISI 1045 tube. The power consumption was measured tool using a power logger (PS2500). KEYENCE VHX-1000 was used to measure flank tool wear. Surface roughness was measured with a Mitutoyo SJ.201. Table 1 shows that design 3 of the textured cutting tool had lower power consumption, flank tool wear, and surface roughness than the non-textured tool under different cutting conditions. While designs 1 and 2 showed higher values of the measured machining outputs compared to the non-textured cutting tool. This indicates the better performance

of design 3 compared to non-textured cutting tools and other textured cutting tool designs. Besides, it can be stated that using a textured cutting insert with a narrow micro-groove can eliminate the negative effects of the derivative cutting phenomena and show up the advantages of using textured cutting tools.

### 3 Performance analysis

This section presents a holistic performance analysis of machining with textured and non-textured tools. Experimental machining results and textured cutting tool preparation processes were included. This analysis evaluates the performance of machining with textured and non-textured cutting tools through life cycle impacts, sustainable machining principles, and surface integrity aspects (e.g., Ra), obtaining the optimized cutting conditions and textures parameters using multi-objective optimization technique. It also offers superiority ranges of the machining with textured and non-textured cutting tools. This analysis includes three consecutive steps identifying the machining system boundary and conducting LCA, selecting the performance analysis metrics, and the decision-making step.

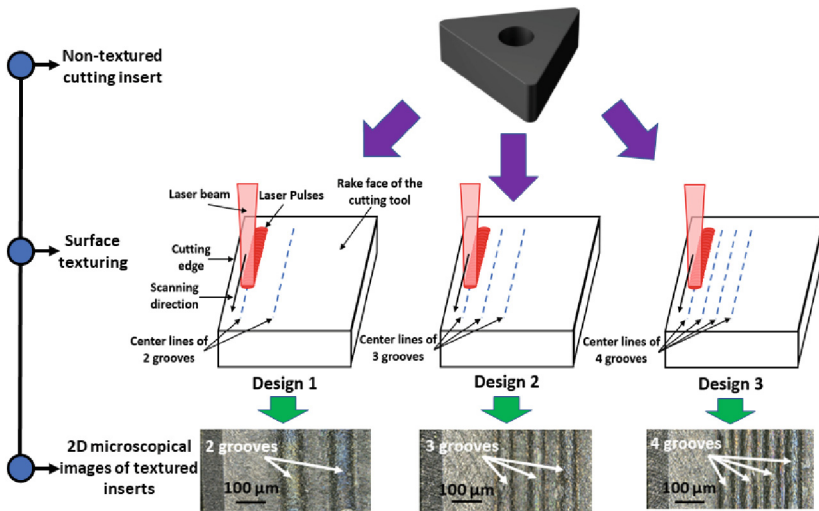


Fig. 1. A schematic showing the preparation process of the three different cutting tool designs

#### 3.1 System Boundary and the Life Cycle Assessment (LCA)

Manufacturing and use life cycle stages are system boundaries for studied machining strategies. It includes the power needed for laser texturing cutting tools and all machining experiments. Preparing textured cutting tools consumes much less power than machining (i.e., use stage). After that, the power consumption of both life stages was included in

conducting the life cycle assessment (Canada electricity mix average Wh was used in the conducted LCA). To obtain the life cycle impact categories, the hybrid assessment model IMPACT 2002+ [10] is selected to determine these impact categories impacts of machining with textured and non-textured cutting tools. The human health category and eco-system quality category were concerned in the current study. SimaPro 9.2 (with European Life Cycle Database\_v3.1) software package was used to conduct IMPACT 2002+ methodology for machining with textured and non-textured cutting tools. Figure 2 shows the endpoint impact contributions of human health and ecosystem quality for the 16 conducted machining tests, measured in (DALY) and (PDF.m2.yr), respectively. It is found that higher human health and ecosystem quality burdens are associated with the non-textured cutting tool and textured tool design 1 (see tests 1, 6, 9, and 14 in Fig. 2). This is because of the higher power consumption associated with these mentioned tests and the derivative cutting accompanying textured design 1 in tests 6 and 14 (at higher feed level). On the other hand, the lower power consumption associated with design 2 and design 3 resulted in lower human health and ecosystem quality (see tests 3, 4, 8, 11, 12, 16 in Fig. 2).

**Table 1.** The experimentation plan of the machining tests

Test #	Vc (m/min)	f (mm/rev)	l ( $\mu\text{m}$ )	W (Watt)	VB (mm)	T (sec/mm <sup>3</sup> )	Ra ( $\mu\text{m}$ )
1	75	0.05	0 (NTT)	2164	0.051	0.016	1.55
2	75	0.05	90 (D1)	2100	0.049	0.016	1.50
3	75	0.05	60 (D2)	2062	0.048	0.016	1.27
4	75	0.05	45 (D3)	2044	0.048	0.016	1.15
5	75	0.1	0 (NTT)	2527	0.060	0.008	2.16
6	75	0.1	90 (D1)	2880	0.068	0.008	2.44
7	75	0.1	60 (D2)	2754	0.064	0.008	2.36
8	75	0.1	45 (D3)	2381	0.058	0.008	2.12
9	150	0.05	0 (NTT)	3195	0.083	0.008	0.52
10	150	0.05	90 (D1)	3121	0.081	0.008	0.50
11	150	0.05	60 (D2)	3109	0.080	0.008	0.49
12	150	0.05	45 (D3)	3006	0.080	0.008	0.49
13	150	0.1	0 (NTT)	3670	0.092	0.004	1.35
14	150	0.1	90 (D1)	4114	0.100	0.004	1.46
15	150	0.1	60 (D2)	3511	0.090	0.004	1.25
16	150	0.1	45 (D3)	3304	0.088	0.004	1.14

NTT: Non-textured cutting tool, D1: textured Design 1, D2: textured Design 2, D3: textured Design 3

### 3.2 Performance Analysis Metrics

The machining performance with textured and non-textured cutting tools was assessed through different performance analysis metrics. The machining outcomes were power consumption, flank tool wear, and average surface roughness. These machining outcomes were included in the performance metrics of resources and power consumption, machining cost, and machined product quality, respectively. Furthermore, the conducted LCA endpoint indicators were also included in the performance analysis model. The endpoints of the ecosystem and human health were selected to present two metrics which are environmental impact and personal health and safety.

### 3.3 Decision Making Stage

The non-dominated optimal cutting conditions for the machining with textured and non-textured cutting tools were generated from the implementation of the sustainability proposed approach presented [5]. The implementation of the performance analysis of both machining strategies was performed under the following steps and assumptions:

*Target machining strategies:* machining using textured and non-textured cutting tools.

*Cutting condition:* {Vc, f, l}.

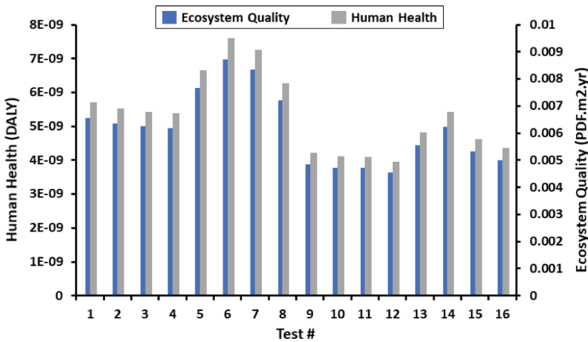


Fig. 2. Endpoint impact contributions of the experimental tests

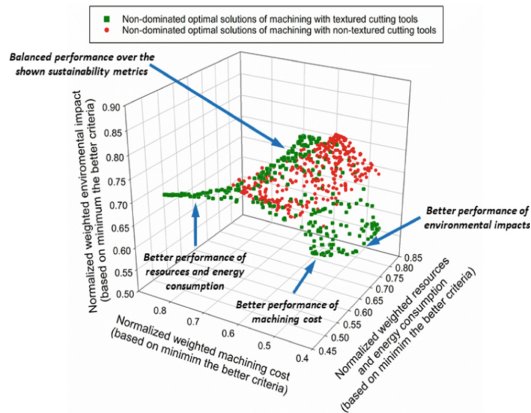
*Sustainable performance indicators:* the obtained endpoint LCA impacts and experimental data cover the resources and energy consumption, machining cost (tool wear and unit volume machining time), environmental impact (eco-system quality), personal health and safety (human health), surface integrity (surface roughness) metrics. The highest values of LCA results and the highest values of the experimental responses are considered reference values of the sustainable indicators.

*Modeling and normalization:* This step is focused on obtaining a model between the selected indicators and the cutting conditions and the textured parameter. Thus, the symbolic regression algorithm Genetic Programming (GP) is selected to produce these models. The goodness of fit of more than 0.97 was obtained for all developed models

in this. The reference values are used to provide the normalized performance indicator models.

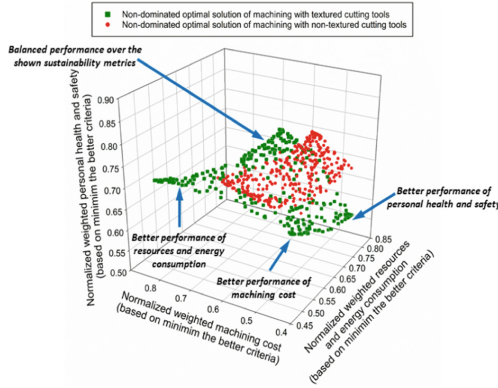
*Multi-objective optimization:* The optimal cutting conditions and the selected textured parameter were determined using the Non-dominated Sorting Genetic Algorithm (NSGA-II). A population size of 800, and a crossover probability of 0.7 were used.

*Non-dominated sorting:* The process of non-dominated sorting was applied to the Pareto-fronts of the studied strategies to determine the non-dominated cutting conditions and textured parameters. These obtained results are shown in Fig. 3, 4, and 5. These figures showed that non-of the optimal solutions for machining with textured cutting tools have been dominated by any optimal solution for machining with non-textured cutting tools. 56.2% of the optimal solutions of machining strategy with non-textured cutting tools have been dominated by the optimal solutions of machining with textured cutting tools. It can be seen from Fig. 3, 4, and 5 that the non-dominated solutions of the machining with non-textured cutting tools show balanced performance over all the sustainability metrics. Non-dominated machining with textured cutting tools shows balanced sustainability metrics. While other non-dominated optimal solutions of machining with textured tools show better performance over studied sustainability metrics.



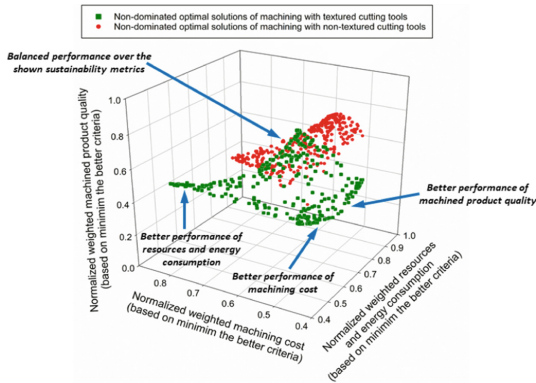
**Fig. 3.** Plots show the machining cost and resources and energy consumption versus the environmental impact of the non-dominated optimal solutions

The conducted performance analysis showed the superiority ranges for machining strategies of using textured and non-textured cutting tools. Non-dominated optimal machining with textured cutting tools outperforms in all sustainability metrics. Non-dominated cutting conditions with non-textured tools provided balanced sustainability analysis metrics. The obtained results introduce a group of non-dominated optimal cutting conditions of machining using textured and non-textured cutting tools. Furthermore, some of the output non-dominated cutting conditions and texture parameters offer the outstanding performance of the studied sustainability metrics, and the others present balanced performances as shown in Fig. 3, 4, and 5. The decision-maker is provided with a reliable selection tool for both studied machining strategies as shown in Fig. 6. It is observed from Fig. 6 that the micro-groove width ( $l$ ) in all cutting conditions of



**Fig. 4.** Plots show the machining cost and resources and energy consumption versus personal health and safety of the non-dominated optimal solutions

the optimal solutions when machining with textured cutting tools is  $45 \mu\text{m}$ . Figure 6 shows four zones of achieving high superiority of target performance metrics for both machining strategies. The first zone (referred to by the blue arrows) of low cutting speed and feed values shows superiority in resources and power consumption metrics. The second zone (referred to by the orange arrows) of low feed and high cutting velocity values shows superiority in machined product quality metrics. The same zone for the strategy of machining with only textured cutting tools (gray arrow) shows superiority of environmental impact, and personal health and safety metrics. The third zone (purple arrows) of high feed and cutting velocity values shows superiority in machining cost metrics. The fourth zone for machining with textured cutting tools (pink arrow) shows high performance in power consumption, and machining cost metrics.



**Fig. 5.** Plots show machining cost and resources and energy consumption versus machined product quality of the non-dominated optimal solutions



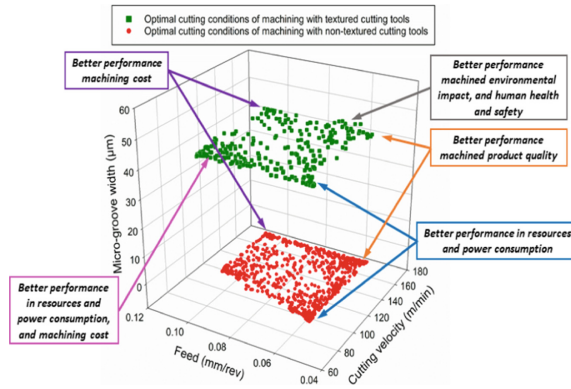


Fig. 6. Cutting conditions of the obtained optimal solutions for both machining strategies

## 4 Conclusions

This study optimized the sustainable performance of machining using textured and non-textured tools by considering existing sustainable machining elements, life cycle assessment impacts, and product quality. Using the laser surface technique, three textured cutting tools with different micro-groove widths were made. Then, machining experiments were conducted to study the effect of the significant textured dimension parameter (micro-groove width) with different machining parameters. Experimental results show that design 3 outperforms non-textured and other textured designs. Using a textured cutting insert with a narrow micro-groove can eliminate the negative effects of derivative cutting and show the benefits of textured cutting tools. Sustainability performance analysis provides superiority ranges for each machining strategy. The optimal cutting conditions map showed four zones where both machining strategies achieved high performance metrics. The optimal micro-groove width for textured cutting tools for all cutting conditions was  $45 \mu\text{m}$ .

**Acknowledgments.** The authors acknowledge the support of the Natural Sciences and Engineering Research Council of Canada (NSERC).

## References

- Jayal, A., Badurdeen, F., Dillon, O., Jr., Jawahir, I.: Sustainable manufacturing: modeling and optimization challenges at the product, process and system levels. *CIRP J. Manuf. Sci. Technol.* **2**(3), 144–152 (2010)
- Kishawy, H.A., Salem, A., Hegab, H., Hosseini, A., Balazinski, M.: Micro-textured cutting tools: phenomenological analysis and design recommendations. *CIRP Ann.* **70**(1), 65–68 (2021)
- Duan, R., Deng, J., Ai, X., Liu, Y., Chen, H.: Experimental assessment of derivative cutting of micro-textured tools in dry cutting of medium carbon steels. *Int. J. Adv. Manuf. Technol.* **92**(9–12), 3531–3540 (2017). <https://doi.org/10.1007/s00170-017-0360-8>

4. Duan, R., Deng, J., Lei, S., Ge, D., Liu, Y., Li, X.: Effect of derivative cutting on machining performance of micro textured tools. *J. Manuf. Process.* **45**, 544–556 (2019)
5. Salem, A., Hegab, H., Kishawy, H.A.: An integrated approach for sustainable machining processes: assessment, performance analysis, and optimization. *Sustain. Prod. Consum.* **25**, 450–470 (2021)
6. Salem, A., Hegab, H., Kishawy, H.A.: Holistic performance analysis during sustainable machining of Inconel 718 with minimum quantity lubrication-based nanofluids. *Int. J. Adv. Manuf. Technol.* **115**(7–8), 2219–2232 (2021). <https://doi.org/10.1007/s00170-021-07276-z>
7. Salem, A., Hegab, H., Rahnamayan, S., Kishawy, H.A.: Multi-objective optimization and innovization-based knowledge discovery of sustainable machining process. *J. Manuf. Syst.* (2022)
8. Salem, A., Hegab, H., Kishawy, H., Rahnamayan, S.: Multi-objective optimization during sustainable machining of difficult-to-cut materials. In: *Proceedings of the Joint Canadian Society for Mechanical Engineering and CFD Society of Canada International Congress* (2019)
9. Hegab, H., Salem, A., Rahnamayan, S., Kishawy, H.: Analysis, modeling, and multi-objective optimization of machining Inconel 718 with nano-additives based minimum quantity coolant. *Appl. Soft Comput.* **108**, 107416 (2021)
10. Jolliet, O., et al.: IMPACT 2002+: a new life cycle impact assessment methodology. *Int. J. Life Cycle Assess.* **8**(6), 324 (2003)

**Open Access** This chapter is licensed under the terms of the Creative Commons Attribution 4.0 International License (<http://creativecommons.org/licenses/by/4.0/>), which permits use, sharing, adaptation, distribution and reproduction in any medium or format, as long as you give appropriate credit to the original author(s) and the source, provide a link to the Creative Commons license and indicate if changes were made.





The images or other third party material in this chapter are included in the chapter's Creative Commons license, unless indicated otherwise in a credit line to the material. If material is not included in the chapter's Creative Commons license and your intended use is not permitted by statutory regulation or exceeds the permitted use, you will need to obtain permission directly from the copyright holder.



# **Planning, Scheduling and Control**



# Waste Minimization by Inventory Management in High-Volume High-Complexity Manufacturing Organizations

Mohamed Afy-Shararah<sup>(✉)</sup> , Sandeep Jagtap , Emanuele Pagone ,  
and Konstantinos Salonitis 

Sustainable Manufacturing Systems Centre, Cranfield University, Cranfield, UK  
m.a.shararah@cranfield.ac.uk

**Abstract.** Organizations that manufacture high volumes of complex products (e.g., pharmaceutical, automotive, food) require specific strategies to ensure efficient processing of parts and a sustainable level of inventory by waste minimization. A review of literature sources revealed how inventory is classified and managed amongst organizations and industries and key challenges that current organizations face with existing inventory management systems. In this paper, these findings are compared against each other to determine best practices and potential shortfalls that should be addressed when trying to manage inventory holistically. A study is then conducted using qualitative data from 15 semi-structured interviews to answer key questions on inventory management based on the findings from the literature survey. Responses are inductively coded and analyzed to reveal the most important factors of inventory management and determine the most prominent themes. A graphical model to represent the findings is also presented. Inventory functional accountability, inventory classification, operational strategies, visual management of inventory data, and efficient processes were some of the key themes known to be critical for effective inventory management and thus illustrated in the graphical model.

**Keywords:** Inventory Management · Sustainability · High Volume · High Complexity

## 1 Inventory Management

Inventory management can be a complex and critical aspect of a business that needs to be proactively managed due to its financial, operational, and environmental impacts [1]. Inventory and production management decisions such as transport frequencies, energy management policies, and production strategies significantly influence emissions generated by transport and storage procedures. Therefore, the efficient management of inventory is crucial to the reduction of carbon emissions. Its importance is emphasized further because it influences all activities related to controlling inventory in the most optimal way to meet one or more business objectives [2]. For example, some of the most common problems faced by manufacturing organizations are underproduction, overproduction,

out of stock situations, delays in the delivery of raw materials (RMs) and discrepancies in inventory [3, 4]. Moreover, facilities with high volumes of complex products are more prone to inventory issues; these production environments are challenging to control inventory due to the product's complexity and respective processes, which are further amplified by its volume. In this work, high complex products are defined according to the following conditions:

- a) require an international supply chain or at least three national suppliers,
- b) manufacturing requires at least ten weeks, including logistic transportation time,
- c) the product requires at least five different manufacturing process families to be manufactured, such as grinding, coating, drilling, welding etc., and
- d) the product comprises at least ten operations in its sequence from the requisition of RMs to dispatch to the customer.

Developing a typology or a classification of inventory helps effectively manage the inventory and align with the organization's priorities. A literature review found that researchers classify inventory by purpose [5], type [6], level of control [7], value [8], or multiple criteria [8, 9].

Perhaps the most common classification is RM, Work in Progress (WIP), and FG (Finished Goods). However, researchers highlight that inventory should not be studied as a monolithic entity because different types of inventory can affect each other [5, 10]. In addition, the imbalances in supply and demand produce a further inventory classification into buffer inventory, cycle inventory, decoupling inventory, anticipation inventory, and pipeline inventory [5]. Another approach to classification is via a hierarchical structure that splits between controlled and uncontrolled variables [7]. The authors claim that controlled variables consisted of item cost, holding cost, shortage cost and procurement cost, and uncontrolled variables consisted of demand, review period, lead time and reorder level. These classification criteria provide a different perspective to view inventory which can be valuable depending on the underlying goal of the organization, and a wide range of mechanisms can impact each one. Multiple classification systems have been studied and compared against the ABC system and found to be more effective; some of these alternatives are deemed more effective [9, 11–13]. However, little has been developed on inventory classification concerning environmental sustainability aspects. In addition, they mainly focused on lot size quantity with minimum possible costs and rarely considered environmental factors. This led to growing concern with regards to environmental challenges. Therefore, significant interest has been shown in developing more sustainable inventory management which is inclusive of environmental, social and economic factors [14, 15].

There are multiple ways that inventory can be classified, many of which have been tested through simulation to prove their merits. Still, none of these simulations represents a real-world application because they do not capture the influence of the human factors [9]. This paper develops a graphical model that highlights the factors to be considered to best manage inventory for high volume complex products in a manufacturing organization and its relation to resource efficiency and the minimization of waste.

## 2 Methodology

This research was carried out in the form of semi-structured interviews with 15 participants to obtain qualitative data. A qualitative approach was chosen to complement the numerous quantitative studies found and to overcome the criticism [9] that existing inventory management models fail to capture human factors and, therefore, are not representative of real-world performance. Also, it helped to develop further insights, fill in the missing gaps identified in the literature review but also to compliment it with supporting or contradicting information to gain a better understanding and evaluation on the topic.

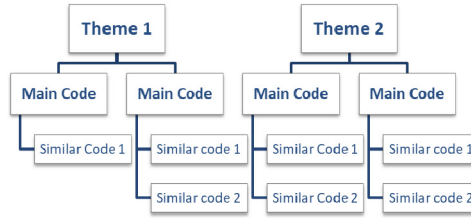
### 2.1 Data Collection

All interviewees belong to multiple organizations but work for the same industry of civil aerospace, gas engine, and turbine blade manufacturers. The selected interviewees were a mixture of managers and staff within organizations that manufactured high volume, highly complex products answering a series of six questions. The decision to involve interviewees from different organizations was motivated by the aim to create a diverse participant list in their roles and facilities. Interviews all took place in person and were audio-recorded and transcribed.

### 2.2 Data Analysis

Once the interviews were recorded, they were all reviewed and amended to ensure the transcriptions were correct to the audio recordings. Transcribed interviews were coded using NVivo, which is a qualitative data analysis computer software package. It allows further analysis by organizing, analyzing and discovering insights from unstructured or qualitative data such as interviews, open-ended survey responses, etc. [17]. Several matrices were used to correlate the codes with questions and codes with the different interview participants, these included weightings based on the frequency of appearance of codes. The weightings is essentially how many times a code appeared across all the interviews resulting in its popularity, the more often a code appeared the more prominent it is.

The literature review provided a basis of what is required for inventory management. However, using deductive coding could have potentially narrowed down the findings too much to the point important subtle information would be omitted. The coding technique used was inductive for each question. It ensured that all themes were captured accurately to support and contradict existing findings in the literature review. Once all coding was completed, a consolidation has been operated based on equivalent meaning, reducing their number from 189 to 91. All 91 codes were used in varying degrees based on the interview responses. These remaining codes were then put under different themes to group them, resulting in 10 themes. Figure 1 provides an example of how the codes and themes are structured. Some of the coding examples are: Increase inventory to protect customer from arrears, Operations are accountable for inventory, Planning & Control are accountable for inventory, everyone is accountable for inventory, etc.



**Fig. 1.** Coding structure

### 3 Discussion

Discussing the most popular codes identified is space-consuming, therefore, for this research paper, the discussion will focus on the themes level rather than the code level. Each of these themes had multiple codes under them, and each of the codes was used in varying amounts across all the transcribed interviews. The themes were also inductive to best group the codes produced. The following Table 1 summarizes the most popular themes developed from the interviews and an explanation of the codes each theme contained. Mapping the themes to the main areas of sustainability (i.e., economic, environmental and social), there is evidence that inventory management in high-volume and high-complexity manufacturing systems does not simply affect economic aspects (as traditionally perceived), but it is relevant also to environmental and social instances. Relatively recent legislative efforts do align financial goals with broader sustainability goals including (at least some) externalities in the balance sheets of enterprises. There is an expectation that this trend will grow further in the coming years, in particular in the regards of environmental impact and resource efficiency. These considerations show how important the optimization of inventory management can cascade in a less obvious way in contributing to sustainability goals.

To cover all the high-level key points extracted from the study, a graphical model (see Fig. 2) was developed. Organizations with high volume complex products could use the model in order to have a good grounding in inventory management. The model represents a manufacturing process flow with WIP at various processes. The process is in the form of a pipeline that is angled to represent the production flow as a constant variable in relation to gravity. The pipeline using gravity also represents a First In, First Out (FIFO) system. However, when there is more inventory in a process than desired, the first in first out system fails to work as expected because the system becomes overloaded and different policy rules (e.g., prioritization and partial orders delivery) are enforced. It reflects the importance of having the correct inventory level at each process. The three key accountable functions: Operations, Planning & Control and Engineering, are highlighted around the model. A conveyor belt below called “Side Processes” represents parts leaving the main pipeline. The conveyor belt is moving parts upwards and thus against gravity to represent the challenge that side processes can have more resistance to processing parts; this is an area that Engineering need to focus on to improve. Some parts may also leave the side process because of not being suitable for the customer; this is a potential case with complex products.

**Table 1.** The identified themes and the explanation of codes they contained categorized according to the three “pillars” of sustainability

Theme	Explanation of codes each theme contained	Economic	Environmental	Social
Accountability	Codes that discuss or specify individuals or functions who should be accountable for inventory management	x		
Awareness, Behaviours and Culture	Codes that mentioned any one or more of those elements in relation to inventory management			x
Data	Codes that related to inventory management data, any data related practices and issues	x	x	x
Efficient Processes	Codes that allude to processes need to be lean, easy to follow, and resource efficient	x	x	
Management & Leadership	Codes that mentioned how senior figures in an organization could influence the way inventory is managed or how they manage other concerns of an organization	x	x	x
Planning & Control	Codes that covered the way inventory can be managed through planning techniques, forecasting and strategies for domestic and the external supply chain	x	x	
Process Compliance	Codes that mentioned compliance issues and importance		x	x
Technology	Codes that highlighted technology in relation to inventory management	x	x	
Visual Management	Codes that alluded to any visual management	x	x	



Planning & Control dictate the launch of inventory dictated by the customer demand and operations. It is because operations report what is in the various processes; this information with customer demand should be used to carefully control the launch of parts to ensure just the right quantity of parts are in the process. There is an optimum level of inventory for each process, this optimum level needs to be visually highlighted to all functions so the correct decisions can be made on inventory prioritization and the correct inventory classification can be applied. The more accurate the planning is in regard to RMs, and FGs needed to satisfy the customer requirements consistently, the less inventory management is required due to fewer errors between actual and forecasted demand. Moreover, controlling the flow of materials by the use of supermarkets and calculated amounts of WIP, will result in less wasteful processes and fewer energy consumed [18].

Operations are directly and solely in charge of “opening the gates” for each operation to allow parts to flow through. Some of these parts may be in batches as they are easier to control. It is illustrated by how the batches of parts are grouped together versus the mix of all sorts of different parts that are difficult to quantify. A weighing scale shows how the inventory management metrics of cost, quantity and slow-moving WIP for each process and area must be balanced with other organizational metrics. Otherwise, effective inventory management can be jeopardized. Flowing through the operations consumes energy and requires resources. Therefore, a lean operation with less waste produced and resources consumed would allow for a more resource efficient system with fewer inventory and less energy required for storage and transportation [16, 19].

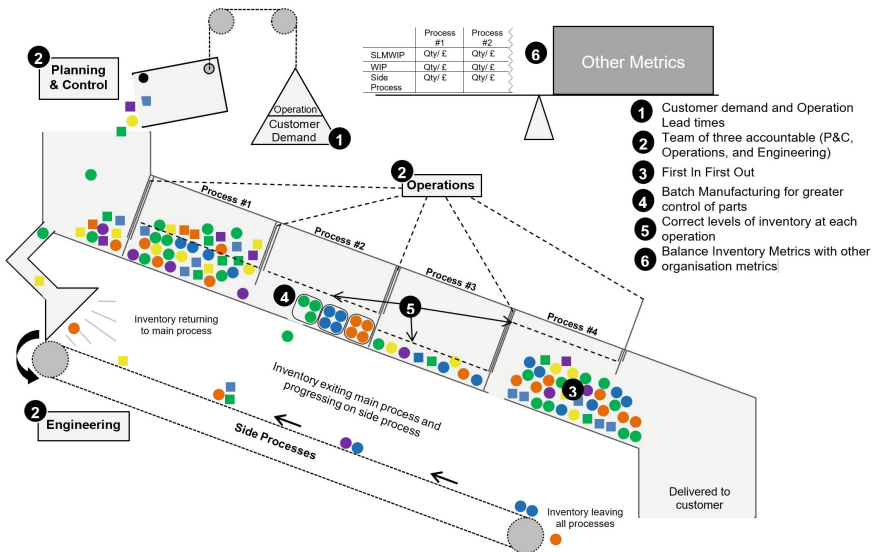


Fig. 2. Graphical model of inventory management for high volume complex products

## 4 Conclusion

Inventory management for high volume complex products requires the cooperation of many areas of an organization with clear decision making, metrics and visualization. When appropriately broken down and sub-categorized, Slow-moving WIP, value and quantity were the main classifications that yielded the most benefit. However, an effective way to manage inventory is to manage the culture and behaviors, manage metrics and their visualization, simplify processes and ensure adequate storage areas on the shop floor. The issues and resolutions were quite vast and broad but consisted of visual management, raising inventory management awareness, improving processes, utilizing technology where possible and processing parts in batches. In particular, improving the processes via lean principles will lead to waste minimization and resource efficiency. Although it was not mentioned to apply different weightings or priorities for different criteria as inventory was not given a score in the organizations involved in this study, business-specific inventory classifications with different weightings for each criterion is suggested. Moreover, the reliance on technology and human factors result in effective inventory management.

**Acknowledgment.** This article is based on the work of Mr. Umer Hussain, a graduate from the Operational Excellence MSc at Cranfield University.

## References

1. Shin, S., Ennis, K.L., Spurlin, W.P.: Effect of inventory management efficiency on profitability: current evidence from the U.S. manufacturing industry. *J. Econ. Econ. Educ. Res.* **16**(1), 98–106 (2015)
2. Jacobs, F.R., Chase, R.B.: *Operations and Supply Chain Management*, Fourteenth McGraw-Hill/Irwin, New York (2014)
3. Chan, S.W., Tasmin, R., Aziati, A.H.N., Rasi, R.Z., Ismail, F.B., Yaw, L.P.: Factors influencing the effectiveness of inventory management in manufacturing SMEs. *IOP Conf. Ser. Mater. Sci. Eng.* **226**, 012024 (2017). <https://doi.org/10.1088/1757-899X/226/1/012024>
4. Afy-Shararah, M., Rich, N.: Operations flow effectiveness: a systems approach to measuring flow performance. *Int. J. Oper. Prod. Manag.* **38**(11), 2096–2123 (2018). <https://doi.org/10.1108/IJOPM-09-2016-0575>
5. Slack, N., Chambers, S., Johnston, R.: *Operations Management*. Pearson Education, London (2010)
6. Eroglu, C., Hofer, C.: Inventory types and firm performance: vector autoregressive and vector error correction models. *J. Bus. Logist.* **32**(3), 227–239 (2011). <https://doi.org/10.1111/j.2158-1592.2011.01019.x>
7. Gupta, A., Garg, R.K., Tewari, P.C.: Inventory selection criteria: a proposed classification. *IUP J. Oper. Manag.* **11**(4), 41–52 (2012)
8. Coker, J., Helo, P.: Demand-supply balancing in manufacturing operations. *Benchmarking Int. J.* **23**(3), 564–583 (2016). <https://doi.org/10.1108/BIJ-04-2014-0028>
9. Lolli, F., Ishizaka, A., Gamberini, R., Rimini, B.: A multicriteria framework for inventory classification and control with application to intermittent demand. *J. Multi-Criteria Decis. Anal.* **24**(5–6), 275–285 (2017). <https://doi.org/10.1002/mcda.1620>

10. May, B.I., Atkinson, M.P., Ferrer, G.: Applying inventory classification to a large inventory management system. *JOSCM J. Oper. Supply Chain Manag.* **10**(1), 68–86 (2017). <https://doi.org/10.12660/joscmv10n1p68-86>
11. Alrjoub, A.M.S., Ahmad, M.A.: Inventory management, cost of capital and firm performance: evidence from manufacturing firms in Jordan. *Invest. Manag. Financ. Innov.* **14**(3), 4–14 (2017). [https://doi.org/10.21511/imfi.14\(3\).2017.01](https://doi.org/10.21511/imfi.14(3).2017.01)
12. Altay Guvenir, H., Erel, E.: Multicriteria inventory classification using a genetic algorithm. *Eur. J. Oper. Res.* **105**(1), 29–37 (1998). [https://doi.org/10.1016/S0377-2217\(97\)00039-8](https://doi.org/10.1016/S0377-2217(97)00039-8)
13. Huiskononen, J.: Maintenance spare parts logistics: Special characteristics and strategic choices. *Int. J. Prod. Econ.* **71**(1), 125–133 (2001). [https://doi.org/10.1016/S0925-5273\(00\)00112-2](https://doi.org/10.1016/S0925-5273(00)00112-2)
14. Partovi, F.Y., Anandarajan, M.: Classifying inventory using an artificial neural network approach. *Comput. Ind. Eng.* **41**(4), 389–404 (2002). [https://doi.org/10.1016/S0360-8352\(01\)00064-X](https://doi.org/10.1016/S0360-8352(01)00064-X)
15. Harris, F.W.: How many parts to make at once. *Oper. Res.* **38**(6), 947–950 (1990). <https://doi.org/10.1287/opre.38.6.947>
16. Pattnaik, S., Nayak, M.M., Abbate, S., Centobelli, P.: Recent trends in sustainable inventory models: a literature review. *Sustainability* **13**(21), Art. no. 21 (2021). <https://doi.org/10.3390/su132111756>
17. AlYahmady, H.H., Al Abri, S.S.: Using Nvivo for data analysis in qualitative research. *Int. Interdiscip. J. Educ.* **2**(2), 181–186 (2013). <https://doi.org/10.12816/0002914>
18. Pagone, E., Salonitis, K., Jolly, M.: Automatically weighted high-resolution mapping of multi-criteria decision analysis for sustainable manufacturing systems. *J. Clean. Prod.* **257**, 120272 (2020). <https://doi.org/10.1016/j.jclepro.2020.120272>
19. Salonitis, K., Jolly, M.R., Zeng, B., Mehrabi, H.: Improvements in energy consumption and environmental impact by novel single shot melting process for casting. *J. Clean. Prod.* **137**, 1532–1542 (2016). <https://doi.org/10.1016/j.jclepro.2016.06.165>

**Open Access** This chapter is licensed under the terms of the Creative Commons Attribution 4.0 International License (<http://creativecommons.org/licenses/by/4.0/>), which permits use, sharing, adaptation, distribution and reproduction in any medium or format, as long as you give appropriate credit to the original author(s) and the source, provide a link to the Creative Commons license and indicate if changes were made.

The images or other third party material in this chapter are included in the chapter's Creative Commons license, unless indicated otherwise in a credit line to the material. If material is not included in the chapter's Creative Commons license and your intended use is not permitted by statutory regulation or exceeds the permitted use, you will need to obtain permission directly from the copyright holder.





# Cascaded Scheduling for Highly Autonomous Production Cells with AGVs

Eddi Miller<sup>(✉)</sup>, Tobias Kaupp, and Jan Schmitt

Institute Digital Engineering, Technical University of Applied Sciences Würzburg-Schweinfurt,  
Ignaz-Schön-Straße 11, 97421 Schweinfurt, Germany

[eddi.miller@thws.de](mailto:eddi.miller@thws.de)

<https://www.thws.de/forschung/institute/idee/>

**Abstract.** Highly autonomous production cells are a crucial part of manufacturing systems in industry 4.0 and can contribute to a sustainable value-adding process. To realize a high degree of autonomy in production cells with an industrial robot and a machine tool, an experimental approach was carried out to deal with numerous challenges on various automation levels. One crucial aspect is the scheduling problem of tasks for each resource (machine tool, tools, robot, AGV) depending on various data needed for a job-shop scheduling algorithm. The findings show that the necessary data has to be derived from different automation levels in a company: horizontally from ERP to shop-floor, vertically from the order handling department to the maintenance department. Utilizing that data, the contribution provides a cascaded scheduling approach for machine tool jobs as well as CNC and robot tasks for highly autonomous production cells supplied by AGVs.

**Keywords:** robot · scheduling · optimization · algorithm

## 1 Introduction

Due to the rapid development in science and industry, manufacturing systems are designed with a higher degree of autonomy with the help of different technologies. To increase productivity and long term competitiveness, companies rely on robots for automated handling and manufacturing tasks with light force requirements as well as AGVs for peripheral logistic processes. Manufacturing systems with multiple machines and one or more corresponding robots are called robotic cells [1]. As of right now, the robots are mostly used for material handling such as loading/unloading parts. AGVs on the other hand are used to transport raw material, finished parts or tools. To efficiently deploy these resources, comprehensive scheduling algorithms are needed which found an increasing interest and growth over the last years. Scheduling algorithms, in particular for the job-shop problem (JSP) are needed when multiple jobs and several tasks in a job need to be scheduled on multiple machines or resources [2]. Generally it can be stated, with higher degree of autonomy in a production system, it is more important to have a powerful scheduling approach to increase the efficient utilization of cost-intensive machine tools, robots and AGVs, see also [3].

© The Author(s) 2023

H. Kohl et al. (Eds.): GCSM 2022, LNME, pp. 383–390, 2023.

[https://doi.org/10.1007/978-3-031-28839-5\\_43](https://doi.org/10.1007/978-3-031-28839-5_43)

In the past decade, there have been many attempts to schedule multiple machines with matheuristics as seen in [4]. The authors contribution revolved around the scheduling of jobs with set tool requirements. While considering release times, due dates and different tool requirements the goal was to minimize the tardiness of operations and tool setup time. To solve this problem, they provided a new matheuristic that combines genetic algorithm and integer linear programming formulation. Another matheuristic to solve multi-objective jobshop-problems was proposed by [5]. Here, the application of jobshop scheduling (JSS) was centered around a robotic cell. As mentioned before, the purpose of the robot is to handle material between machines or different work stations. Considering that, the authors came up with a Teaching Learning Based Optimization algorithm that aims to minimize makespan and the total earliness and tardiness. The same approach of employing a robot to handle material between multiple machines is shown by [6]. Nonetheless, robots in production cells can not only be used for material handling. As seen in [7], robots can also perform collaborated tasks, especially if there is downtime between material handling jobs. To acquire these so called “robot-collaborated processes” (RCP), the authors lean into Tabu Circulatory Time Point algorithms. While considering different constraints, the algorithm optimizes the order in which the robot can move.

Creating an optimization algorithm requires various data and constraints. These, in the case of the JSP, stem from different levels of automation in a company and various systems in the actual engineering and production IT-environment. In Fig. 1 the vertical and horizontal automation levels are shown.

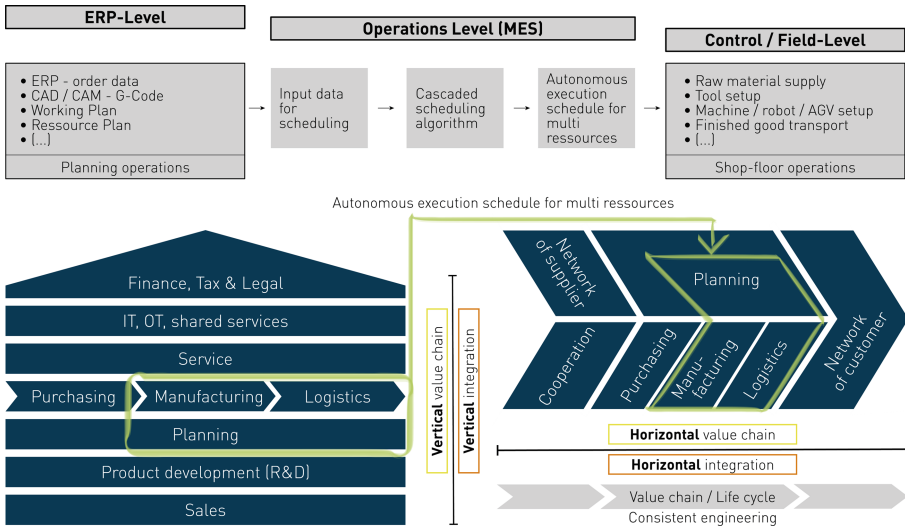


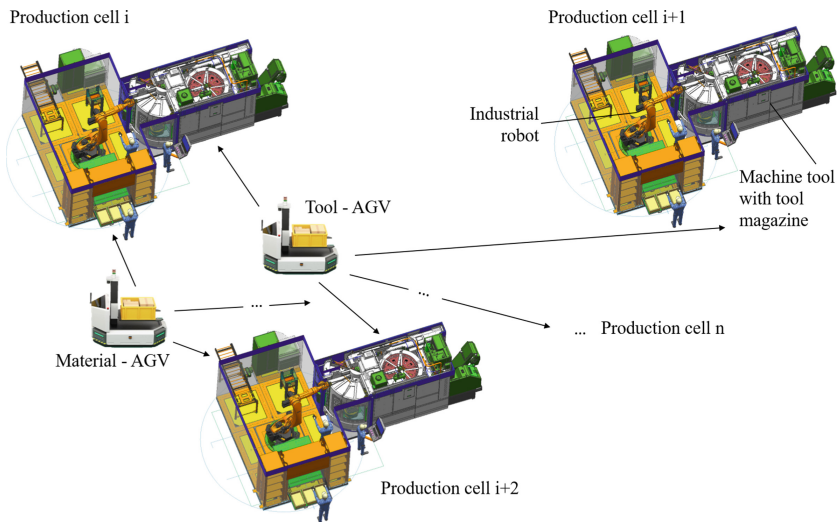
Fig. 1. Vertical and horizontal automation levels

Within the vertical integration, the data are provided by functional organizations inside a company while the horizontal integration focuses on the value adding chain. In sustainable companies the IT landscape should be embedded in a product-lifecycle-management software. Nonetheless, the reality shows data format breaks are present and various data sources for machine capacity, available tools, customer jobs and tasks from work plans are needed for a scheduling algorithm for highly autonomous manufacturing systems [8]. In this paper, an approach is demonstrated on how to schedule both, jobs and their corresponding tasks. The first part is to schedule the superordinate jobs in regards to tool management. The aim is to reduce changeover time of multiple robotic cells which undergo tool change provided by an AGV. The second part is to schedule subordinate tasks of each job to contemplate for the possibility of robot-collaborated processes.

## 2 Problem Definition and Scheduling Model

This section provides insight into the current manufacturing setup and how the machinery is established. Additionally, two of the main problems that emerge from these robotic cells will be explained and how they affect the selection of scheduling methods. At last, the chosen scheduling model will be elaborated.

This contribution does not concentrate on robotic cells with one robot and multiple machines but rather on a machine tool park where each machine is equipped with one robot (see Fig. 2). Here, raw material and tools are handled and provided by AGVs for all robotic cells. The first AGV is responsible for providing raw material while also carting off finished parts, if the shelf is full. The purpose of the second AGV is to supply all machines with the corresponding tools needed for the assigned jobs on the machine.



**Fig. 2.** Manufacturing setup

In this kind of manufacturing system setup there are two main problems:

**Problem 1.** The first problem arises from the fact that there are some machines which share the same tools. In this case, the tools, which are provided via AGV, have to be scheduled efficiently to reduce tool changeover and AGV run time.

**Problem 2.** The second problem is related to the robot. At first, the sole purpose of the robot was material handling e.g. to load parts in the machine and unload them. After handling the parts, while the machine is working, the robot stands still. To avoid idle time, robot-collaborated tasks will be incorporated into the jobs. Therefore, tasks have to be scheduled between machine and robot to minimize makespan.

As elaborated in Sect. 1, there are many different optimization algorithms and metaheuristics. Considering the two main problems, that jobs as well as tasks have to be scheduled while also considering different constraints like tool availability and manufacturing task order, an already existing method stood out. The chosen model to solve the underlying problem is a combination of constraint programming (CP) and Boolean satisfiability (SAT) called CP-SAT. Constraint programming has already been proven to be a suitable solution for the jobshop problem, as seen in [9–12]. The authors use CP in combination with other techniques, such as mixed integer linear programming, to solve different kinds of JSP. As the name Constraint Programming implies, it integrates the possibility to set constraints to solve combinatorial optimization problems [13].

### 3 Constraint Programming Algorithms

In this section, the previously mentioned restrictions and constraints extracted from the actual engineering and production environment will be considered and elaborated. These constraints are split into two different parts for job and task scheduling. Next, the CP algorithms will be further explained, especially concerning tool management and task allocation of different resources.

For all robotic cells, in regards to job and task scheduling different assumptions had to be made. The following points address premises for job scheduling respecting tool management.

1. All machines  $M_i$  ( $i = 1, 2, \dots, M$ ) can manufacture all parts  $J_n$  ( $n = 1, 2, \dots, N$ )
2. Every production order can be assigned to any machine
3. Each machine can manufacture only one part at a time
4. All production intervals on one machine can not overlap
5. All parts in a lot/order are identical and are processed consecutively
6. Specific tool sets  $T_i$  ( $i = 1, 2, \dots, T$ ) are shared between all machines
7. These specific tool sets can only be used in one machine at a time
8. Raw material and finished parts are handled by an AGV

with  $M$  being the total amount of machines,  $N$  the amount of parts to process and  $T$  the number of tool sets available. Considering all eight assumptions the first algorithm was built to schedule all jobs/parts onto all available machines  $M_{1...i}$ . The algorithm is given the number of available machines and all production orders with the process duration and tool sets needed. After all jobs have been scheduled, the tasks inside of each job also undergo scheduling to allow for robot-collaborated processes. For this reason, a second algorithm, which is similar to the first one, was established and was equipped with the following assumptions.

1. The first and last task  $P_i$  ( $i = 1, 2, \dots, P$ ) are loading and unloading the machine
2. The robot  $R_i$  ( $i = 1, 2, \dots, R$ ) is capable of taking over processes from the machine (RCP)
3. The duration of RCP cannot be longer then the main process of the machine  $M$
4. Technological sequences have to be followed

with  $P$  containing all tasks of job  $J_i$  and  $R$  being the total amount robots. The algorithm considers manufacturing sequences and assigns tasks from the machine to the robot for less idle time. The advantage of the existing CP models is that there are predetermined constraints like “AddNoOverlap” [14] which can be applied to certain problems. Nonetheless, to solve the first problem mentioned in Sect. 2, a tool change penalty was implemented. The algorithm scans for all possible job sequences on all machines, then takes one job with a specific tool set and compares all other jobs to it and checks if the tool set is different. If the compared job has a deviating tool set, the algorithm imposes penalty and writes it into a variable. The objective of the algorithm is now to minimize the makespan as well as minimizing the tool change penalty variable.

For the second problem of task allocation between two resources, a similar approach was taken. When looking at the tasks, it is important to clarify which tasks of the machine can be done by the robot. The algorithm then checks all possible combinations of task assignments for the smallest makespan and puts them into an efficient order.

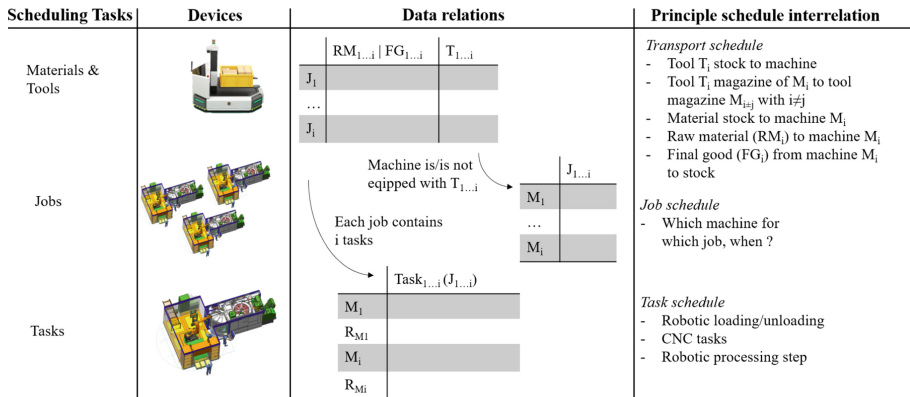


Fig. 3. Interrelation of the devices in a robotic cell



Figure 3 summarizes all necessary components and their relations, starting from the AGV that supplies raw material to the last task of a job that unloads the finished part from the machine.

### 4 Application on Production Data

This section displays the scheduling results of the algorithms. As mentioned before, the first task is to schedule jobs based on tool availability and tool change. After the jobs have been scheduled, each job is split into its tasks to again minimize the makespan. This is achieved by robot incorporated processes of the robot in each corresponding robotic cell. The results of the algorithms will be shown using real production data.

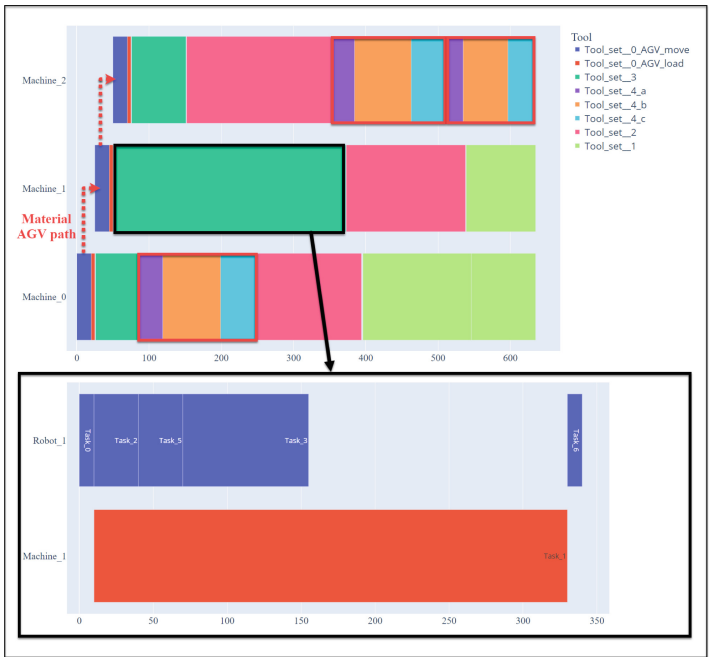


Fig. 4. Top - Automated job scheduling on three machines, bottom - task scheduling between machine and robot

The data basis for job scheduling are jobs and their corresponding duration and used tool sets. Each tool set is equipped with a number of tools needed for the specific job and NC program. As seen in Fig. 4, there is a total of 12 jobs scheduled on three machines. Before the first job on every machine, an AGV provides raw material to all machines sequentially (red dotted arrows). After a machine is provided with material, it can start the first order and the AGV supplies the next machine. Looking at tool set 4 (red boxes), there is no overlap of usage between all machines, since this tool set is only available once. To further clarify tool sets, tool number 4 was split into three sub tools which are used in succession.

When looking into each of the jobs, they include the manufacturing process of the part and post processing steps, such as deburring and washing. For the latter, the tasks will be scheduled onto the robot. Since there are tasks that can be executed by both the machine and the robot, the algorithm searches for all possible combinations and allocates all tasks to the most fitting resource by minimizing the makespan of the job. As seen in Fig. 4 (bottom part), while the machine is manufacturing (Task 1), the robot takes over the post processing of the previously manufactured part in the lot. The process duration of the robot is in the chosen exemplary use-case always less than the main process of the machine. Hence, the robot will be ready to unload the part to eliminate idle time of the machine. The result of the job and task scheduling provides plan of jobs with the smallest possible makespan and changeover time, while integrating both resources machine and robot as far as possible.

## 5 Conclusion and Further Research

In this work we provide a scheduling approach for production orders and their subordinate tasks with allocation to different resources. The algorithms are based on a CP-SAT scheduling approach, combining constraint programming and Boolean satisfiability. While considering numerous constraints derived from real production environments, the algorithms are applied to real production data of different sources e.g. the ERP system, work and tool plans as well as factory layout data. The results are production order and task schedules that minimize makespan and reduce tool changeover time. This also improves vertical automation in a company on the ERP and planning level, by shortening capacity planning and shift management, as these are generated automatically. Additionally, the algorithm further enhances horizontal levels in the form of value adding processes in the production environment. Autonomous AGVs relieve workers from monotonous work like filling shelves or moving material which benefit the social dimension of the three pillars of sustainability. The focus on the efficient use of materials and resources enables for ecological and sustainable production. As the last pillar economics, a high degree of autonomy provided by scheduling with multiple resources facilitates the long-term competitiveness of a company. The high flexibility of multiple robotic cells further facilitate the application of a wider product portfolio while reducing resources in the form of material and tool optimization.

Further research includes the consideration of single tools inside of different tools sets. To enhance to scheduling reliability, the actual changeover time of tools between two jobs has to be integrated. It is also thinkable to consider the allocation of single tools from a tool set after it is been used. This could impede long idle times resulting from changing a lot of tools at once. Another important topic would be combining both algorithms into one. This would allow for actual implementation in a production environment.

## References

1. Yi, J., Ding, S., Song, D., Zhang, M.T.: Steady-state throughput and scheduling analysis of multicenter tools: a decomposition approach. *IEEE Trans. Autom. Sci. Eng.* **5**(2), 321–336 (2008)

2. Sonmez, A., Baykasoglu, A.: A new dynamic programming formulation of (nxm) flowshop sequencing problems with due dates. *Int. J. Prod. Res.* **36**(8), 2269–2283 (1998)
3. Michael, L.P.: *Scheduling: Theory, Algorithms, and Systems*. Springer, Cham (2018)
4. Dang, Q.V., van Diessen, T., Martagan, T., Adan, I.: A matheuristic for parallel machine scheduling with tool replacements. *Eur. J. Oper. Res.* **291**(2), 640–660 (2021)
5. Li, X., Yang, X., Zhao, Y., Teng, Y., Dong, Y.: Metaheuristic for solving multiobjective job shop scheduling problem in a robotic cell. *IEEE Access* **8**, 147015–147028 (2020)
6. Ghadiri Nejad, M., Kovács, G., Vizvári, B., Barenji, R.V.: An optimization model for cyclic scheduling problem in flexible robotic cells. *Int. J. Adv. Manuf. Tech.* **95**(9), 3863–3873 (2018)
7. Zhou, B.H., Li, M.: Scheduling method of robotic cells with robot-collaborated process and residency constraints. *Int. J. Comput. Integr. Manuf.* **30**(11), 1164–1178 (2017)
8. Parente, M., Figueira, G., Amorim, P., Marques, A.: Production scheduling in the context of industry 4.0: review and trends. *Int. J. Prod. Res.* **58**(17), 5401–5431 (2020)
9. Zhang, S., Wang, S.: Flexible assembly job-shop scheduling with sequence-dependent setup times and part sharing in a dynamic environment: Constraint programming model, mixed-integer programming model, and dispatching rules. *IEEE Trans. Eng. Manage.* **65**(3), 487–504 (2018)
10. Novas, J.M.: Production scheduling and lot streaming at flexible job-shops environments using constraint programming. *Comput. Ind. Eng.* **136**, 252–264 (2019)
11. Meng, L., Zhang, C., Ren, Y., Zhang, B., Lv, C.: Mixed-integer linear programming and constraint programming formulations for solving distributed flexible job shop scheduling problem. *Comput. Ind. Eng.* **142**, 106347 (2020)
12. Lunardi, W.T., Birgin, E.G., Laborie, P., Ronconi, D.P., Voos, H.: Mixed integer linear programming and constraint programming models for the online printing shop scheduling problem. *Comput. Oper. Res.* **123**, 105020 (2020)
13. Rossi, F., Van Beek, P., Walsh, T.: *Handbook of constraint programming*. Elsevier, Amsterdam (2006)
14. Google-ORTools: Python reference CP-SAT module. [https://developers.google.com/optimization/reference/python/sat/python/cp\\_model](https://developers.google.com/optimization/reference/python/sat/python/cp_model). Accessed 12. May 2022

**Open Access** This chapter is licensed under the terms of the Creative Commons Attribution 4.0 International License (<http://creativecommons.org/licenses/by/4.0/>), which permits use, sharing, adaptation, distribution and reproduction in any medium or format, as long as you give appropriate credit to the original author(s) and the source, provide a link to the Creative Commons license and indicate if changes were made.

The images or other third party material in this chapter are included in the chapter's Creative Commons license, unless indicated otherwise in a credit line to the material. If material is not included in the chapter's Creative Commons license and your intended use is not permitted by statutory regulation or exceeds the permitted use, you will need to obtain permission directly from the copyright holder.





# A Model to Balance Production Workload Distribution in a Trailer Manufacturing Organisation Under Fluctuating Customer Ordering Condition

Gerhard van der Walt<sup>1</sup>, Olasumbo Makinde<sup>2</sup>(✉), and Khumbulani Mpfu<sup>1</sup>

<sup>1</sup> Tshwane University of Technology, Pretoria 0001, South Africa

<sup>2</sup> University of Johannesburg, Johannesburg 2028, South Africa

olasumbom@uj.ac.za

**Abstract.** Trailer manufacturing organisation considered in this study is currently experiencing a high volume of backlog orders due to its poor balancing of production workload distribution during capacity planning and scheduling. This issue has resulted in loss of sales orders experienced by the trailer manufacturing organisation. In light of this, this research study developed a model that could be used to balance production workload distribution that could be used to timeously meet varying customer orders as well as drastically minimise the backlog cost experienced in a trailer manufacturing organisation. To achieve this, on the one hand, a system model of the current production workload distribution used at this trailer manufacturing organisation was developed using AnyLogic software and parametrized using the manufacturing system operation operating conditions obtained via system observation for a period of three (3) months, in order to identify the bottleneck stations and inefficiencies present within this organisation. On the other hand, design of experiments, equipped with feasible workload control strategies were conducted on the model. The result of the simulated model revealed that the usage of an additional two bending machines and two primer paint workers, usage of additional three laser machines and three treatment workers, Heijunka order dispatching principle and Constant Work-In-Process (ConWIP) will increase the service level and mean machine capacity utilisation of the organisation, as well as reduce the backlog cost, opportunity cost and average order lead time.

**Keywords:** Workload Distribution · Heijunka · ConWIP · Backlog Orders

## 1 Introduction

Manufacturing organisations are forced to always continuously monitor their production processes in order to identify the inefficiencies present within their processes and thereafter implement strategic changes that could help to alleviate these inefficiencies, thereby improving the productivity of a manufacturing organisation (Li 2013). The study of Lodding (2013) indicated that there is a high chance that some or all of the production processes/workstations in an organisation could experience limited manufacturing capacity,

© The Author(s) 2023

H. Kohl et al. (Eds.): GCSM 2022, LNME, pp. 391–400, 2023.

[https://doi.org/10.1007/978-3-031-28839-5\\_44](https://doi.org/10.1007/978-3-031-28839-5_44)

which thus make these processes/workstations to be tagged as bottlenecks/constraints experienced in the organisation. According to Kolinski and Tomkowiak (2010), Hsaio et al. (2010) and Betterton and Silver (2012), bottlenecked workstation is defined as a workstation that limit the efficiency of a production process, thereby exhibiting lowest level of productivity amidst other workstations present within an organisation. Bottlenecked workstations tends to dictate the throughput rate exhibited by a system, thereby contributing to the phenomena of high waiting of WIP inventories, backlogged customer order and significant amount of underutilisation of subsequent workstations (Li 2009).

Theory of Constraint (TOC) has been identified by previous researchers to address this issue. According to Goldratt et al. (2004) and Buddas (2014), the various steps that needs to be undertaken to apply TOC in an organisation include identification of the system bottleneck, decision on how to exploit the system bottleneck, subordination of bottlenecked workstation and elevation of the bottlenecks. A lot of studies such as Urban and Rogowska (2018), Sari et al. (2019), and Lizarralde-Aiastui et al. (2020) have used myriads of methods to identify bottlenecks present in an organisation. However, to the best of the authors' knowledge, there are no case studies within the trailer manufacturing organisation that has applied simulation models in this regard. Simulation is defined as a means of imitating the behaviour of a system by means of a model (Kikolski 2016). Simulation model could be deployed as a means determining the performance of the current system used in an organisation as well as facilitate decision making that will help improve the performance of a system. Simulation promote a holistic picture of the behaviour of processes used in an organisation. It could also be used, when it is not feasible to obtain a solution to an industrial problem by means of analytical method or experiments (Ojstersek and Buchmeister 2020). Simulation could also be used to track myriads of operations carried out in an organisation for a period of few hours to years, if need be, hence, suitable to achieve short and long term decision making (Ojstersek et al., 2020). Simulation could be deployed as a means of pinpointing anomalies that could negatively affect the performance of production processes used in an organisation (Parv et al., 2021). However, in the context of this study, simulation will be deployed, on the one hand, to identify the bottlenecks contributing to high customer order backlogs experienced in a trailer manufacturing organisation. On the other hand, it will be used as means of validating the strategies that could be used to elevate the identified bottlenecks and subordinate other workstations, towards reducing the backlog experienced in the organisation as well as exponentially improve the productivity achieved in the organisation.

The structure of the paper is highlighted as follows. Section 2 present the methodology deployed in this study towards developing a simulation model for the case study trailer manufacturing organisation. Section 3 present and discuss the results of the simulation model while the last section conclude based on the results obtained from the study and thereafter unveil the future research work.

## 2 Methodology

A quantitative research design approach premised on the use of a discrete-event simulation modelling approach was deployed in this study. The first phase of the simulation

modelling approach involves the observation and note taking of the production processes used in the case study trailer manufacturing organisation by the authors. The second phase involves the collection of historical data such as the work station cycle time, number of customer orders per day, capacity of the work station and the work order release method used in the organisation. A summary of the data collected through system observation and elicited from archival data for use in this study is depicted in Table 1.

**Table 1.** Summary of data collected from a Trailer Manufacturing Organisation

Model Parameters	Value		Workstation	Capacity	Processing Time (Hours)
			Primer Paint		1
Customer demand/month	200 units of trailers		Tac Weld 1 station	1	Random.Triangular (1, 2, 3)
Duration of simulation study	3 months. Therefore total demand equal to 600 trailers		Robot Weld 1	1	Random.Triangular (1, 1.5, 2)
Customer order arrival rate/day	3–6 customer order exponentially arrive per day		Tac Weld 2	1	Random.Triangular (2, 2.2, 3.6)
Number of customer arrival/period	1		Robot Weld 2	1	Random.Triangular (1.8, 2, 2.5)
Operations duration of the organisation	6 days per week at a rate of 24 working hours/day, which equals to 1728 h of simulation run		Chassis Assembly	1	Random.Triangular (2, 2.5, 3)
Workstation	Capacity	Processing Time (Hours)	Painting	1	Random.Triangular (2, 2.5, 3)
Laser cutting machine	1	Random.Triangular (5, 10, 12)	Final Assembly	1	Random.Triangular (6, 6.2, 6.5)
Computer Numeric Control (CNC) machine	1	Random.Triangular (3, 6, 9)	Quality Control (QC) Inspection	1	Random.Triangular (0.5, 1, 1.5)
Treatment station	1	Random.Triangular (4, 10, 12)			

The third phase involves the modelling and parametrization of the current work ordering release and production mechanism of the trailer manufacturing organisation using AnyLogic software package. The summary of the procedure used to model and

parametrize the current work ordering release and production mechanism of the trailer manufacturing organisation is highlighted as follows:

- 1) Drag a *source node*, *twelve stations*, *eleven queues* (where customer order and WIP inventories will wait when the stations are busy), and a *sink node* into the AnyLogic interface.
- 2) Drag *four points* into the interface. Name the first two points as *Start 1* and *Start 2* and the last two points as *End 1* and *End 2* respectively. The first two points measure the time customer order spent waiting before it is been released for processing while the last two points measure the lead time and flow time to produce a trailer product respectively.
- 3) Parametrize the *name*, *order arrival/day*, *agent per arrival* and *maximum number of order arrivals* of the source node as *Trailer\_Orders*, *uniform.discrete(3, 6)*, *1* and *600* respectively.
- 4) Activate the *enable exit on timeout*, with a view to ensure that customers withdraw their orders, if a customer order is not released for production within a period of 7 days. Define the *queueing rule* to be *FIFO* and the *queueing capacity* to be *100*.
- 5) Set the processing time of each workstation to be the processing time of each associated workstation captured in Table 1.
- 6) Use the *Parameter function* on the AnyLogic software to parametrize various metrics such as manufacturing cost, backlog cost and revenue generated by the organisation.
- 7) Deploy the *Chart function* on AnyLogic software and parametrize it with *Revenue (R) parameter*, *Cost (C) parameter* and *Backlog Cost (Z) parameter* respectively.
- 8) Set the value of *C* as *sink.count() x production cost/order*
- 9) Set the value of *R* as *sink.count() x selling price/order*
- 10) Set the value of *Z* as *{sourceorder.count() - sink.count()} x backlog cost/order*
- 11) Define another *parameter*, *Profit (P)* under the *Chart function* and set its value as  $R - (C + Z)$ .
- 12) Create a *time plot graph function* to visually display the time spent in processing WIP units against the time spent to wait for the dispatch of the order to the production line for processing. Therefore, set the *first data set name* to plot as *wait for manufacturing* and its value as *Queue\_to\_manufacturing.StatsSize.Mean* and set the *second data set name* to plot as *WIP* and its value as  $queue1\_CNCbendingmachine\_Statsize.Mean() + queue2\_treatmentstation\_Statsize.Mean() + queue3\_primerpaint\_Statsize.Mean() + queue4\_tacweld1\_Statsize.Mean() + queue5\_robotweld1\_Statsize.Mean() + queue6\_tacweld2\_Statsize.Mean() + queue7\_robotweld2\_Statsize.Mean() + queue8\_chassisassembly\_Statsize.Mean() + queue9\_painting\_Statsize.Mean() + queue10\_finalassembly\_Statsize.Mean() + queue11\_qualitycontrolinspection\_Statsize.Mean()$
- 13) Run the statistics of the average queue length for the entire system by using *queue.Statsize.Mean()*.
- 14) Create a *backlog cost function* to display the number of orders backlogged, which deploys a value;  $\{sourceorder.count() - sink.count()\} x backlog cost/order$ , to generate the plot.

- 15) Measure the average utilisation of each workstation by means of *StatsUtilisation.Mean()* function. Plot the results on the *Bar Chart* by using the values of: *lasercutting\_StatsUtilisation.Mean()*, *CNCbendingmachine\_StatsUtilisation.Mean()*, *treatmentstation\_StatsUtilisation.Mean()*, *primerpaint\_StatsUtilisation.Mean()*, *tacweld1\_StatsUtilisation.Mean()*, *robotweld1\_StatsUtilisation.Mean()*, *tacweld2\_StatsUtilisation.Mean()*, *robotweld2\_StatsUtilisation.Mean()*, *chassisassembly\_StatsUtilisation.Mean()*, *painting\_StatsUtilisation.Mean()*, *finalassembly\_StatsUtilisation.Mean()*, and *qualitycontrolinspection\_StatsUtilisation.Mean()*, respectively.
- 16) Lastly, create a *time plot* to visually display the flow time for the orders processed using the appropriate data set.

The last research phase involves the design of experiment, which comprises of simulation of suitable strategy that have the potential of elevating bottlenecks present in this manufacturing organisation as well as reducing the customer order backlog. The developed simulation model of the trailer manufacturing organisation considered in this study is presented in Fig. 1.

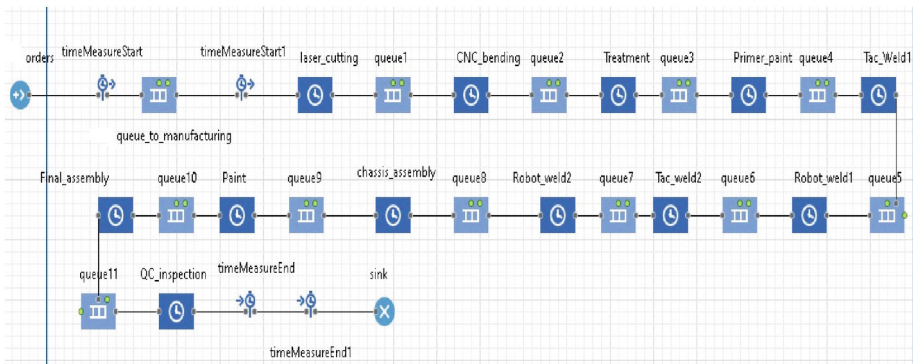


Fig. 1. System Model of the trailer manufacturing organisation

### 3 Results and Discussion

#### 3.1 Simulation Results of the Performance of the Manufacturing System Used in the Trailer Manufacturing Organisation

##### 3.1.1 Results for the Revenue, Cost, Profit, Throughput and Service Level of the Organisation

During the three month simulation, the trailer manufacturing organisation generated a profit of \$822909 at a revenue of \$2.47 million and a total operations cost of \$1.65 million. It is evident that the organisation has an opportunity cost of \$3.82 million due to orders that were cancelled by customers who had waited longer than the specified lead



time of seven days. The total backlog cost incurred by the organisation accumulated to \$4.4 million. In addition, based on the simulation result, the organisation received a total of 370 confirmed customer orders. They managed to complete and deliver 133 of the required orders with a balance of backlog orders that amount to 237. This gives them a service level percentage of 35.95%.

### 3.1.2 Simulation Results of the Lead Time, Flow Time and Machine Average Capacity Utilisation at the Trailer Manufacturing Organisation

The average flow time to produce a trailer based on the total flow time distribution experienced over a period of three months is 48.58 h. Based on the result of the simulation, one could therefore conclude that the minimum, average and maximum manufacturing time that could be used to complete a customer order are 40 h, 48.58 h and 58 h respectively. After analysing the distribution of the lead time over a period of three (3) months, it is evident that the average lead time to produce a trailer is 174.84 h, which is more than the double of the average flow time. One could therefore already claim that the waiting time for orders to be dispatched is high owing to the manufacturing line experiencing capacity constraints. The capacity constraints experienced by the organisation is evident since on the one hand, there were very long queue of orders, which ranges between 23 to 43 WIP orders waiting to be sent to the manufacturing station. On the other hand, the organisation experienced unbalanced workstation capacities utilisation as depicted in Fig. 2.

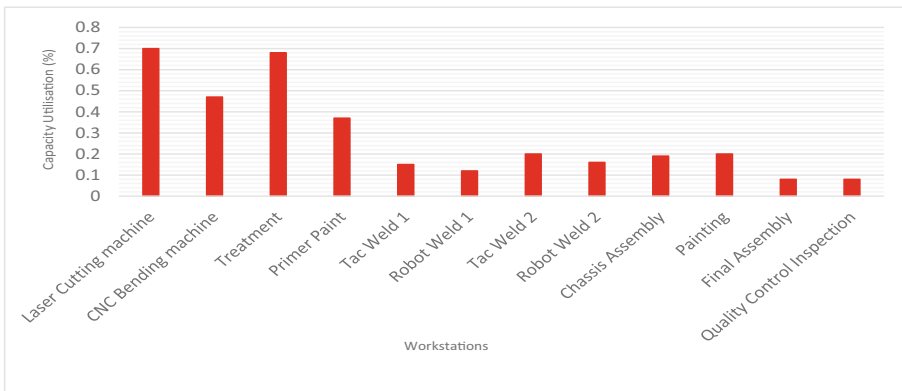


Fig. 2. Workstation Average Capacity Utilisation for a period of 3 months

Figure 2 revealed that the average capacity utilisation is unequally distributed among the machines with a mean total utilisation of only 28.33%. The workstation with the highest utilisation is the laser machine workstation with a 70% utilisation factor and the least utilised workstations are the final assembly and QC sections with only 0.08%. The sum of the average utilisation possess the required capacity to meet the customer demand but the organisation needs to look at line balancing of the stations that are causing a bottleneck in the process. In turn, they cause the company to suffer backlog

cost and unhappy customers. In light of this, the authors pinpointed the laser machine workstation as the primary bottlenecked station while the treatment, bending and primer workstations were identified as the secondary bottlenecked workstations.

### **3.2 Strategies to Improve the Productivity and Reduce the Backlog Cost of the Organisation**

In order to exploit and elevate the bottlenecks experienced in the organisation, the TOC and line balancing principle were deployed by the authors, which thus unveils the following strategies:

1) Increment of the capacity of lasers and bending machines used in the organisation by three and two fold respectively, 2) Increment of the capacity of the treatment and primer paint sections by three and two fold respectively, 3) Change from push to pull by utilising one-piece flow, CONWIP, and Heijunka dispatching principle, and 4) Better order management at the sales site to reduce the variability of incoming orders using workload control and customer enquiry management principle.

The ideology behind this order management principle is that the planning section now has an order release mechanism to control the amount of work on the shop floor. After applying better order management, the sales and planning team in the organisation is expected to receive live feedback from the production team and can now accept more orders per day. Therefore, only the pre-shop pool waiting time is considered to vary. Since the shop floor workload is stabilised, more shop floor throughput time is allowed. The total capital required to purchase the new machines as well as hire additional labourers required at the treatment and primer paint sections would increase the total operating cost of the organisation by \$12993 which was therefore, factored into the improvement model.

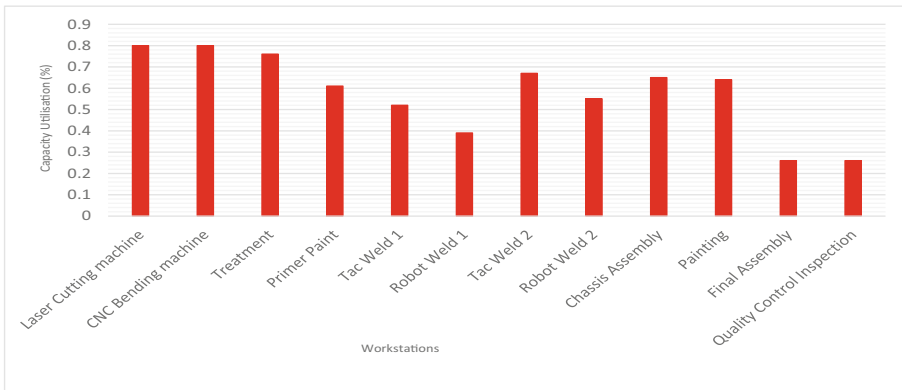
#### **3.2.1 Simulation Results of the Revenue, Cost, Profit, Throughput and Service Level for the Improved Manufacturing System of the Trailer Manufacturing Organisation Using the Proposed Strategies**

For the improvement model, during the three month simulation, the trailer manufacturing organisation is expected to generate a profit of \$2.48 million at a revenue of \$8.26 million and a total operations cost of \$5.78 million. It is evident that the organisation is expected to have an opportunity loss cost of \$0. The total backlog cost is expected to reduce to \$1.04 million. In addition, based on the simulation result, the organisation is expected to receive a total of 501 confirmed customer orders. The organisation is expected to complete and deliver 445 of the required orders with a balance of backlog orders that amount to 56. This will give the organisation a service level percentage of 88.82%.

#### **3.2.2 Simulation Results of the Lead Time, Flow Time, and Machine Average Capacity Utilization for the Improved Trailer Manufacturing System Model**

The average flow time to produce a trailer based on the total flow time distribution experienced over a period of three months is 51.09 h. One could therefore conclude that the minimum, average and maximum manufacturing time that could be used to

complete a customer order are 36 h, 51.09 h and 66 h respectively. After analysing the distribution of the lead time over a period of three (3) months, it is evident that the average lead time to produce a trailer is 83.88 h, which is closer to the average flow time, as compared to the simulation result of the current manufacturing process of the organisation. A bottleneck occurred at the waiting order station where orders wait to be released into the manufacturing process with an average WIP of  $9.84 \approx 10$ . Therefore, the organisation is expected to experience a semi-equally distributed workload among the workstations (see Fig. 3) with a mean total utilisation of 57.58%, if the proposed strategies are implemented in the organisation.



**Fig. 3.** Workstation Average Capacity Utilisation for the improved system model for a period of 3 months

The station with the highest utilisation is the laser machine workstation with an 80% utilisation factor and the least utilised workstations are the final assembly and QC sections with 26% utilisation. It can also be observed that the utilisation is more evenly distributed than that of the simulation result of the current trailer manufacturing process. This indicates that the trailer production line is balanced compared to that of the current trailer manufacturing process. The total mean utilisation is much higher than that of the current trailer manufacturing process, which indicates that the company would achieve better throughput. In light of this, it could be inferred that the organisation: (i) trailer throughput in terms of customer order received and processed, and total revenue would increase by 35.41% and 234.59%, (ii) backlog cost, opportunity cost and lead time would reduce by 76.37%, 42.23% and 52.02%, and the (iii) service level, and mean capacity utilisation would increase by 52.88%, and 29.25% respectively, if the trailer manufacturing organisation considered in this study implement the strategies proposed in this study. The process simulation exercise conducted in this study unveil cost-effective solutions that are tailored towards improving the productivity and service level of the trailer manufacturing organisation at a minimized operations cost, while maximizing the capacity utilisation of the organisation.

## 4 Conclusion

In this study, on the one hand, we explored how system modelling and simulation could be used to validate the strategies that could be used to reduce backlog cost owing to high customer order backlog experienced in a trailer manufacturing organisation. On the other hand, we also investigated how system modelling and simulation could be used to elevate bottlenecks as well as balance the production line of a trailer manufacturing organisation towards improving its productivity and revenue. The result of the simulation exercise pinpointed that the organisation experienced high fluctuations in machine capacity utilisation. It was also observed that the laser machine is the primary bottleneck workstation while the treatment, bending and primer paint processes are the secondary bottleneck workstations. In order to address this aforementioned issue, it was asserted by means of simulation that increment of the capacity of the laser and treatment workstations by three folds, increment of the capacity of the bending machine and primer paint workstations by two folds, and the use of a pull system would reduce the backlog cost experienced in the organisation by 76.37%, as well as increase the machine capacity utilisation and service level of the organisation by 29.25% and 52.88%, if these proposed strategies are deployed in the trailer manufacturing organisation considered in this study. Implementation of the proposed strategies at the trailer manufacturing organisation and measurement of their impact need to be explored in future studies.

## References

- Betterton, C.E., Silver, S.J.: Detecting bottlenecks in serial production lines—a focus on interdeparture time variance. *Int. J. Prod. Res.* **50**(15), 4158–4174 (2012)
- Buddas, H.: A bottleneck analysis in the IFRC supply chain. *J. Humanit. Logist. Supply Chain Manag.* **4**(2), 222–244 (2014)
- Goldratt, E.M., Cox, J., Whitford, D.: *The Goal: A Process of Ongoing Improvement*. North River Press, Great Barrington (2004)
- Hsiao, Y., Lin, Y., Huang, Y.: Optimal multi-stage logistic and inventory policies with production bottleneck in a serial supply chain. *Int. J. Prod. Econ.* **124**(2), 408–413 (2010)
- Kikolski, M.: Zastosowanie Plant Simulation w analizie wydajności produkcji wybranego elementu szafki podtynkowej [Plant Simulation application in the analysis of productivity of the selected item-mounted cabinets]. In: Knosala, R. (ed.) *Innowacje w zarządzaniu i inżynierii produkcji* [Innovation in management and production engineering], pp. 579–588. Oficyna Wydawnicza Polskiego Towarzystwa Zarządzania Produkcją, Opole, Poland (2016)
- Koliński, A., Tomkowiak, A.: The use of the concept of the analysis of bottlenecks in production management. *Gospodarka Materiałowa i Logistyka* **9**, 16–21 (2010)
- Li, J.: Continuous improvement at Toyota manufacturing plant: applications of production systems engineering methods. *Int. J. Prod. Res.* **51**(23–24), 7235–7249 (2013)
- Lizarralde-Aiastui, A., Apaolaza-Perez de Eulate, U., Mediavilla-Guisasola, M.: A strategic approach for bottleneck identification in Make-To-Order environments: a Drum-Buffer-Rope Action research-based case study. *J. Ind. Eng. Manag.* **13**(1), 18–37 (2020)
- Lödding, H.: Fundamentals of capacity control. In: Lödding, H. (ed.) *Handbook of Manufacturing Control*, pp. 473–490. Springer, Heidelberg (2013)
- Ojstersek, R., Acko, B., Buchmeister, B.: Simulation study of a flexible manufacturing system regarding sustainability. *Int. J. Simul. Model.* **19**(1), 65–76 (2020)

- Ojstersek, R., Buchmeister, B.: Simulation modeling approach for collaborative workplaces' assessment in sustainable manufacturing. *Sustainability* **12**(10), 1–18 (2020)
- Parv, A.L., Deaky, B.A., Stasiak-Betejewska, R.: Sustainable manufacturing systems—a simulation model. In: *IOP Conference Series: Materials Science and Engineering*, vol. 1009, pp. 1–6 (2021)
- Sari, R.M., Syahputri, K., Rizkya, I., Siboro, N.: Optimization in critical work center using theory of constraints. In: *IOP Conference Series: Materials Science and Engineering*, vol. 648, no. 1, pp. 1–5 (2019)
- Urban, W., Rogowska, P.: The case study of bottlenecks identification for practical implementation to the theory of constraints. *Multidiscip. Aspects Prod. Eng.* **1**(1), 399–405 (2018)

**Open Access** This chapter is licensed under the terms of the Creative Commons Attribution 4.0 International License (<http://creativecommons.org/licenses/by/4.0/>), which permits use, sharing, adaptation, distribution and reproduction in any medium or format, as long as you give appropriate credit to the original author(s) and the source, provide a link to the Creative Commons license and indicate if changes were made.

The images or other third party material in this chapter are included in the chapter's Creative Commons license, unless indicated otherwise in a credit line to the material. If material is not included in the chapter's Creative Commons license and your intended use is not permitted by statutory regulation or exceeds the permitted use, you will need to obtain permission directly from the copyright holder.





# Enabling Sustainable Consumption: Development of an Inventory Management Tool for Food Recovery

Chelsea Dean<sup>1</sup>, Fazleena Badurdeen<sup>1,2(✉)</sup>, and Kendra OoNorasak<sup>3</sup>

<sup>1</sup> Department of Mechanical Engineering, University of Kentucky, Lexington, KY 40506, USA

Badurdeen@uky.edu

<sup>2</sup> Institute of Sustainable Manufacturing, Lexington, KY 40506, USA

<sup>3</sup> Department of Dietetics and Human Nutrition, University of Kentucky, Lexington, KY 40506, USA

**Abstract.** The food supply chain presents numerous challenges from farm to fork resulting in over one third of all food produced going to waste. These challenges uniquely affect the level of food insecurity among regional populations. Food lost in the production and manufacturing stages of the supply chain are most influential in developing nations. Meanwhile the retail and consumer stages substantially affect food wasted in developed nations. The project described in this paper applies a systems-based approach to evaluate the inventory management needs for a charitable food recovery organization (FRO) and develop a tool for more effective management of recovered food. The capabilities to be incorporated in the tool are identified through an in-depth literature review and a current state assessment of the FRO's system. Influential relationships and feedback loops are examined to provide a central view of inventory assets, how they are acquired and dispersed. The easy-to-use tool is then developed to interface with existing data collection mechanisms at the FRO. The paper will detail the research involved and necessary steps taken to provide accurate sustainability and inventory reporting for the FRO for more effective food recovery. Limitations of the tool and potential improvement opportunities will also be discussed.

**Keywords:** Food Waste Recovery · Inventory Management · Sustainability Reporting

## 1 Introduction

More than 2.3 billion people around the world are food insecure while one third of edible food is lost or wasted [1]. The industrial economy has evolved and diversified over time, yet the process of linear production and consumption has remained largely unchanged. The United Nations Food and Agricultural Organization (FAO) describes food loss as any food that is disposed of before reaching the retail level of the food supply chain [2]. Food waste refers to the disposal of food at the retail and consumer level of the food supply chain (FSC). Food waste commonly occurs when fresh produce is not

aesthetically optimal for retail sales, food date labels are confused or misinterpreted, and food is unused or leftover from foodservice and households [2]. The cost of food waste was estimated at 1 trillion USD in 2014 making the need to address food waste a financial affair [3]. Furthermore, the environmental impact of food waste includes each resource consumed and all pollutants emitted to produce, process, transport and ultimately dispose of food fit for consumption.

Previous work emphasizes inventory management capabilities along the FSC to decrease food loss and waste [4]. Food recovery efforts can divert edible food from the FSC to mitigate waste, but research regarding the solicitation of web-based tools utilized within FROs is limited. Food rescue applications such as MealConnect enable donors to connect to FROs directly which necessitates an understanding of inventory capacity and stock levels. Work management platforms such as Smartsheet are used to track inventory and manage waste for FROs, but the financial constraint is not suitable for small-scale organizations. This project applies a systems-based approach to identify the activities of a local FRO and to create an inventory management tool that is easy to use and affordable. The tool will increase data transparency and complement the physical inventory management strategy used at the facility. Food waste solutions and FSC stakeholder claims identified through the literature review will supplement the tool requirements outlined by the FRO. This assessment facilitates defining local stakeholders, understanding how food waste is measured, and identifying relevant tool capabilities. Feedback from the FRO will validate the tool's features and the dynamic visualization of information. Limitations and potential improvement opportunities are described before conclusions are made.

## 2 Review of Sustainable Solutions for Food Waste

Linear consumption follows the 'take-make-dispose' model where resources are harvested or extracted to produce, manufacture, and distribute goods [5]. Businesses are observing higher resource prices, increased resource volatility and additional disruptions to supply chain operations. In terms of the industrial economy, circularity refers to an economy that is restorative or regenerative by design [5]. Food recovery presents an opportunity to improve circular economy (CE) practices by diverting waste from disposal channels to provide meals and surplus food items to those in need. The concept of CE requires the application of sustainable practices and innovation to remain viable over time [6].

In the Post-2015 Development Agenda, the UN adopted 17 Sustainable Development Goals (SDGs) as a global development framework [7]. SDG 12.3 aims to promote sustainable consumption by reducing food loss and food waste by 50 percent. A food waste index has been proposed by the UN, enabling institutions to accurately measure food waste [1]. Sustainable consumption is a challenge to the conventional form of consumerism that requires new solutions. Sharing economy solutions place providers in direct contact with consumers and eliminates the social stigma of food sharing [8]. Sharing economy solutions such as food recovery are enabled by transparency and routine practice. The food waste index can be used to establish best practices in measuring food recovery and food distribution for FROs.

Technological tools can improve FSC operations by increasing the accuracy of measuring material input, production output and waste generated [9]. Digital information sharing can integrate food waste management strategies across all stages of the FSC to collect, redistribute, and process food waste sustainably (see Fig. 1). Utilizing a systems-based approach for tool development will detail the methodology and research applied in the process. Additionally, the objectives and strategies to promote effective response are identified using a systems-based approach [10].

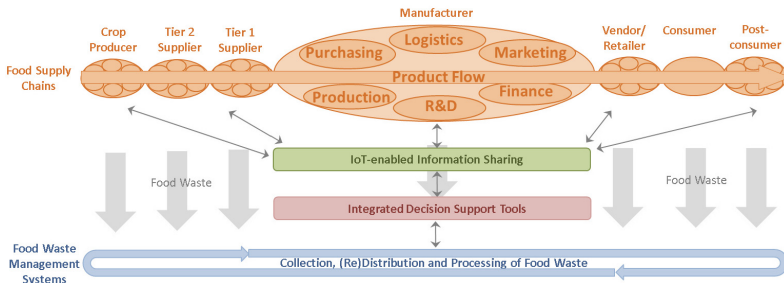


Fig. 1. Integrated Framework for Food Waste Prevention and Management [9]

### 3 Systems-Based Approach for Tool Development

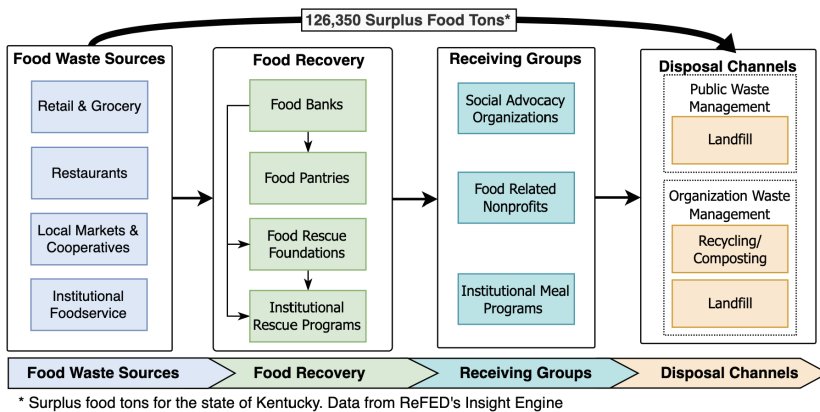
The building block principle of systems modeling describes a model as consisting of one problem, or equation, and the dynamic forms in which that problem can be realized [11]. Simple systems contain one module and complex system models contain one or more module groups. This project uses a set of simple system models that represent the activities of a local FRO. The stakeholder diagram described in this section is used to determine the route of edible food waste and define influential stakeholders outside of the focal FRO. This diagram can be used to determine where any organization fits into the food waste recovery supply chain. The causal loop diagram discussed in this section identifies the internal operations and relationships in the focal FRO. These relationships are carried over into a stock and flow diagram to determine the key components used to measure food waste recovery.

**Defining Local Stakeholders.** Local food waste stakeholders (see Fig. 2) represent active participants in the FSC that directly relate to the focal FRO studied in this project. Food Waste Sources are organizations that produce both edible and inedible food waste. Food Recovery stakeholders recover food fit for human consumption and redistribute that food to feed people. Receiving Groups are the organizations that accept recovered food from Food Recovery stakeholders. Disposal Channels are the pathways for food waste. Finally, food recovery groups work to divert edible food from these disposal channels.

**Campus Kitchen and its Stakeholders.** Campus Kitchen (CK) at the University of Kentucky is a nonprofit student run FRO dedicated to reducing food waste and food



insecurity through action and awareness. In 2019 an estimated 126,350 surplus food tons were wasted in Kentucky due in part to food safety regulations that require immediate rescue response time [13]. Institutional FROs such as CK can act quickly to receive and distribute this surplus food while following the necessary food safety regulations. There are three key activities for CK volunteers – food recovery, meal preparation, and delivery. The CK program director has described volunteer roles and responsibilities that will be considered during tool development. Implementing new technology and a new process to capture inventory data was not feasible due to the additional training required and volunteer turnover. Shift leaders utilize a web-based survey to record the activities completed during their shift. An opportunity exists to automate the analysis process and provide side by side information on different inventory types. Automated inventory management systems allow organizations to save significant cost in terms of physical inventory counts, administrative errors, inventory tracking, and stock shortages [12].



**Fig. 2.** Local Food Waste Stakeholders

**Causal Loop Diagram Construction.** With stakeholder relationships defined, the next step is constructing a causal loop diagram (CLD) to identify the critical path of CK operations. A CLD aids in visualizing how variables in a dynamically complex system are interrelated [14]. CLDs are structured by words and arrows to create a simple yet expressive representation of the relationships and feedback loops in a system (see Fig. 3). Words depicted on the CLD are variables that have value, which change over time. The arrows represent a positive or negative relationship between two variables. Multiple iterations of CLD construction were completed to identify a closed system boundary where the tool can measure key performance indicators [10].

**Designing the Stock and Flow Diagram.** A stock and flow diagram differentiates the parts of a system using variable definitions from the CLD. Business and inventory management use stocks and flows to describe the quantities in a system. A stock is the value of an asset at a particular point in time [14]. In Fig. 4 the amount of food accepted is

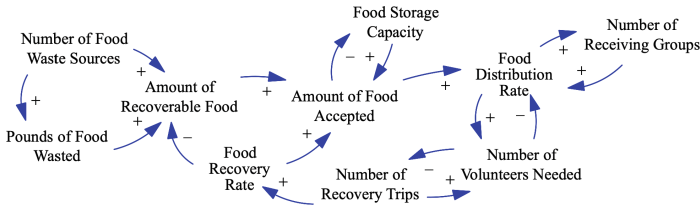


Fig. 3. Causal Loop Diagram of CK operations

the stock for CK. Flow variables are measured over an interval of time and describe the rate of change of a stock. The food distribution rate (see Fig. 4) describes the amount of accepted food that is leaving the system when meals are made. The food recovery rate refers to the amount of recoverable food that is accepted over time. The clouds in the diagram represent the sources and sinks of the process flow which are not directly measured in the system and do not impose limitations on the system.

A stock list will measure the level of inventory inputs and outputs [15]. The web-based survey completed at the end of each shift in CK captures the stock list data. Stock input is measured by the weight of food recovered. The weight of delivered food and food compost measure the stock output. Ingredients removed from stock for cooking are not included in the survey. This measurement method leaves a gap of information for food in the cooking process.

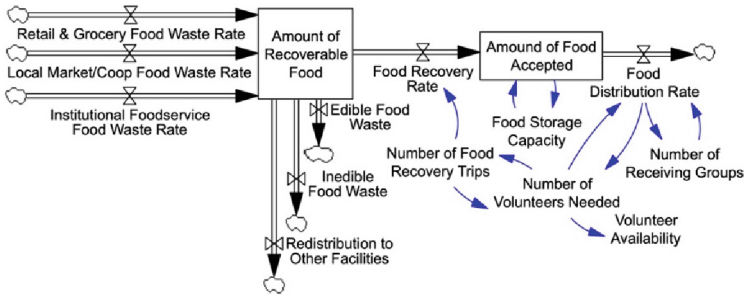


Fig. 4. Stock and Flow Diagram of CK Operations

### 4 Methodology for Tool Development and Testing

At the end of each semester, the executive team at CK is responsible for recording and analyzing food recovery and distribution data, currently done manually. The semester report includes four sections – food recovery, food distribution, social engagement and environmental impact. Using the tool developed will automate this reporting process and provide real-time data measured by semester, month, and day. This section describes the methodology used to automate the data analysis process.

**Determining Tool Capabilities.** Tool design will incorporate ad-hoc management practices. Ad-hoc management provides key criteria information based on what the organization's stakeholders deem necessary [16]. The tool will provide flexibility and clarity in the decision-making process by separating data by two concerns – inventory tracking and impact reporting. Advocates of ad-hoc views maintain that the separation of concern reduces the confusion caused by displaying all information in one view [16]. The dynamic inventory displays will consist of a monthly, daily, and location report. The impact report is a separate aspect view containing the financial, social, and environmental data to be used for the end of semester/semi-annual reporting.

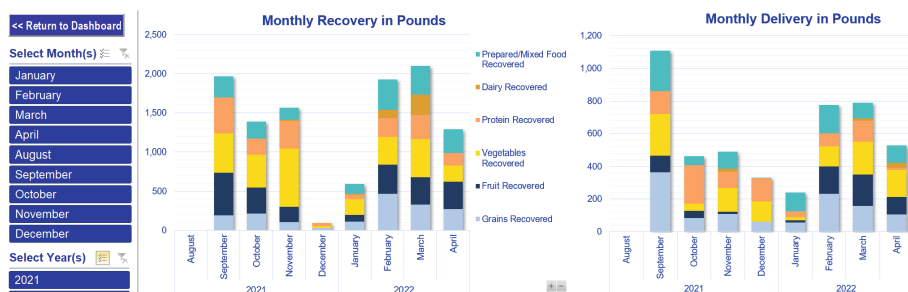
**Platform-Based Design.** Internal stakeholder experience with existing technology was the main determinant for the tool platform. The survey data is imported to Power Query in Microsoft Excel to clean up the data and apply simple mathematical operations where needed. The data transformation process includes removing columns that do not contain inventory information and renaming columns to signify the impact to inventory (i.e., grains recovered, meals delivered, and vegetables composted). The data is loaded to Excel where pivot tables are used to aggregate information and quantify inventory assets.

**Verifying and Validating Tool Specifications.** Industrial practices are increasingly reliant upon technological tools to enhance decision making. Data and visual accuracy are important to developers, users, and decision-makers. Verification and validation are used to determine whether a tool is correct [17]. Verification checks that a tool meets the design specifications. During development the tool was verified by loading small sets of survey responses to the tool and comparing those results to hand calculations. This process can be used for post-development verification. Validation confirms that the tool specifications meet the needs of the executive team and CK volunteers. Users of the tool were heavily involved in the development process and a final review of the tool will validate that the requirements have been met.

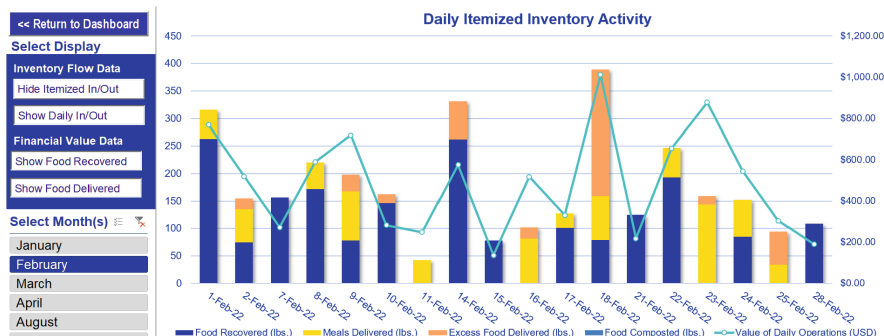
**Results.** The tool contains four displays as shown in Table 1. Each display contains pivot tables and charts to summarize survey responses based on concern. Inventory input and output data is contained in each report based on three levels of granularity – monthly, daily, and semi-annually/by semester. The timeframe for the data report is selected by the user. Additionally, the impact report contains the environmental and social influence of CK operations.

**Table 1.** Dynamic Displays in the Inventory Tool

Dynamic Display	Concern
Monthly Report	Overview of food recovery and meal delivery inventory constructed for the Director to compare monthly performance. (see Fig. 5)
Daily Report	Verification of daily recovery inputs and delivery/waste outputs for the purpose of inventory tracking and process improvement. (see Fig. 6)
Impact Report	Determines the financial, environmental, and social influence of food recovery and distribution by semester/semi-annually (see Fig. 7)
Location Report	Improves communication between internal and external stakeholders by aggregating monthly recovery and meal delivery data by location



**Fig. 5.** Inventory Tool Monthly Report



**Fig. 6.** Inventory Tool Daily Report

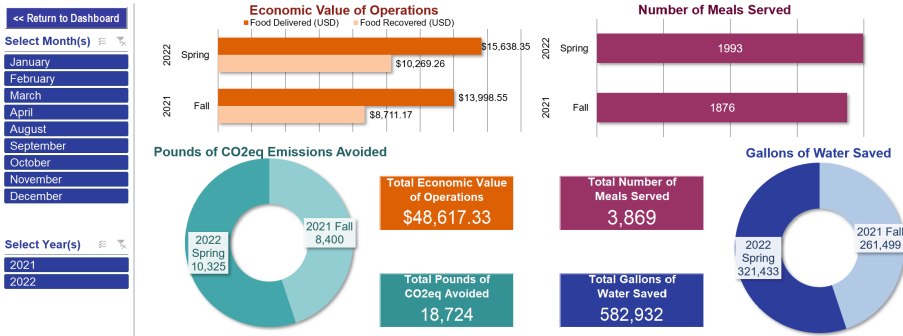


Fig. 7. Inventory Tool Impact Report

## 5 Conclusions and Future Work

The food waste problem is a complex issue that must be addressed using comprehensive strategies to understand the dynamic relationships impacting the FSC. Facilitating FROs reduces the amount of food wasted by diverting edible food from disposal channels and redistributing that food to people. Food recovery does not address the overabundance of food produced and served, but it promotes a circular economy by eliminating waste. Understanding the problem and enabling sustainable consumption requires recognition of the multidisciplinary nature of the FSC as a system. Food waste research regarding FROs is spread across the entire food supply chain and is often generalized as an act of good will. Current web-based tools and smart phone applications have a high potential for expanding food rescue measures, but a scalable application that addresses all FRO activities requires further investigation. This project aims to contribute to food waste management research through the scope of an FRO inventory management system and encourage further academic research regarding scalable low-cost strategies that increase the intervention FROs have on food waste.

The systems-based approach used to develop this tool adapts traditional inventory management techniques to fit within the constraints of a charitable FRO. The tool features metrics defined by food waste stakeholders to quantify the economic, environmental, and social assets of the organization. The results of this tool provide an automated view of inventory activity with generalized sustainability indicators. Potential improvements to the tool include—modeling the relationship between volunteer activity and inventory data, applying a greenhouse gas index to increase environmental impact reporting, and tracking the food category types to determine where food processing activities could extend shelf life or increase nutritional value.

## References

1. World Health Organization: The State of Food Security and Nutrition in the World 2021: Transforming food systems for food security, improved nutrition, and affordable healthy diets for all. Food & Agriculture Organization (2021)

2. United Nations FAO: What is food loss and food waste? <https://www.fao.org/food-loss-and-food-waste/flw-data>. Accessed 01 Feb 2022
3. United Nations FAO: Food Wastage Footprint. <https://www.fao.org/nr/sustainability/food-loss-and-waste>. Accessed 30 Mar 2022
4. Bajželj, B., Quested, T.E., Rös, E., Swannell, R.P.: The role of reducing food waste for resilient food systems. *Ecosyst. Serv.* **45**, 101140 (2020)
5. MacArthur, E.: Towards the circular economy. *J. Ind. Ecol.* **2**(1), 23–44 (2013)
6. Pistikopoulos, E.N., Baratsas, S., Avraamidou, S.: A systems engineering framework for the optimization of food supply chains under circular economy considerations. *Sci. Total Environ.* **794**, 148726 (2021)
7. Brundtland, G.: Report of the World Commission on Environment and Development: Our Common Future. United Nations General Assembly Document A/42/427 (1987)
8. Richards, T., Hamilton, S.: Food waste in the sharing economy. *Food Policy* **75**, 109–123 (2018)
9. de los Mozos, E., Badurdeen, F., Dossou, P.: Sustainable consumption by reducing food waste: a review of the current state and directions for future research. *Procedia Manuf.* **51**, 1791–1798 (2020)
10. Lee, C.K.M., Ng, K.K.H., Kwong, C.K., Tay, S.T.: A system dynamics model for evaluating food waste management in Hong Kong, China. *J. Mater. Cycles Waste Manage.* **21**(3), 433–456 (2018). <https://doi.org/10.1007/s10163-018-0804-8>
11. Burgess, T.: Systems analysis and modeling: a macro-to-micro approach with multidisciplinary applications. *J. Oper. Res. Soc.* **53**(12), 1398 (2002)
12. Aro-Gordon, S., Gupte, J.: Review of modern inventory management techniques. *Glob. J. Bus. Manag.* **1**(2), 1–22 (2016)
13. ReFED's Impact Calculator. <https://insights-engine.refed.org/impact-calculator>. Accessed 04 Apr 2022
14. Sterman, J.: *Business Dynamics*. McGraw-Hill Inc., United States (2000)
15. Davis, E.: Inventory flow analysis. In: Swamidass, P.M. (eds.) *Encyclopedia of Production and Manufacturing Management*. Springer, Boston (2000). [https://doi.org/10.1007/1-4020-0612-8\\_458](https://doi.org/10.1007/1-4020-0612-8_458). Accessed 30 Mar 2022
16. Hepworth, A., Misopoulus, F., Manthou, V., Dyer, R., Michaelides, R.: Exploring ad-hoc portfolio management: does it work, and is it the flexibility that supports project portfolio management? *Procedia Comput. Sci.* **121**, 345–355 (2017)
17. Sargent, R.: Verification and validation of simulation models. In: *Proceedings of the 2010 Winter Simulation Conference*, pp. 166–183. IEEE, Baltimore MD (2010)

**Open Access** This chapter is licensed under the terms of the Creative Commons Attribution 4.0 International License (<http://creativecommons.org/licenses/by/4.0/>), which permits use, sharing, adaptation, distribution and reproduction in any medium or format, as long as you give appropriate credit to the original author(s) and the source, provide a link to the Creative Commons license and indicate if changes were made.

The images or other third party material in this chapter are included in the chapter's Creative Commons license, unless indicated otherwise in a credit line to the material. If material is not included in the chapter's Creative Commons license and your intended use is not permitted by statutory regulation or exceeds the permitted use, you will need to obtain permission directly from the copyright holder.





# Resource-Efficient Process Chains for the Production of High-Performance Powertrain Components in the Automotive Industry

Berend Denkena<sup>1</sup>, Benjamin Bergmann<sup>1</sup>, Marcel Wichmann<sup>1</sup>, Miriam Handrup<sup>1</sup>,  
Daniel Katzsch<sup>1</sup>, Philipp Pillkahn<sup>1</sup>(✉), Leon Reuter<sup>1</sup>, Christopher Schmidt<sup>1</sup>,  
and Frederik Stelljes<sup>2</sup>

<sup>1</sup> Institute of Production Engineering and Machine Tools, Leibniz University Hannover, An Der  
Universität 2, 30823 Garbsen, Germany  
pillkahn@ifw.uni-hannover.de

<sup>2</sup> Institute of Technical Combustion, Leibniz University Hannover, An Der Universität 1,  
30823 Garbsen, Germany

**Abstract.** This paper focuses on process chains for power train components of passenger cars and heavy duty vehicles. In the project “Powertrain 2025” particular attention is being paid to increase the resource efficiency of the manufacturing process chains and reduce energy demand during service life. In detail cylinder liners are equipped with an adapted geometry and topography which reduces friction losses. Process chains for chassis components are investigated and optimized in order to increase the resource efficiency during manufacturing, service life and maintenance. In addition, process chains for the manufacturing of drive shafts are adjusted. By eliminating hard machining, energy is saved and friction losses are reduced by laser machining of microstructures. Furthermore, micro dimples are applied in vane pumps, which leads to a tribological improvement and thus enhances their friction behaviour. Moreover, a system architecture for process planning is developed and ecologically optimized process parameters are calculated. For a final consideration, a calculation software is developed which enables to calculate the main energy consumption of the manufacturing processes and the carbon footprint for the expected service life. A weight reduction of the powertrain components of 4.5 kg per vehicle and a potential annual energy saving of 13,073 MWh is obtained.

**Keywords:** Resource Efficiency · Automotive Industry · Process Chains

## 1 Introduction

Particularly in the automotive industry, process chains for manufacturing motor vehicles are highly complex. Furthermore, the individual processing steps are energy-intensive. Against the background of global warming, this process chains have the potential to

---

The original version of this chapter was revised: A citation was added to the legend of figure 1 and figure 2, and the corresponding reference was added in the reference list. Moreover, a typo was corrected in the body text referred to those figures. The correction to this chapter is available at [https://doi.org/10.1007/978-3-031-28839-5\\_122](https://doi.org/10.1007/978-3-031-28839-5_122)

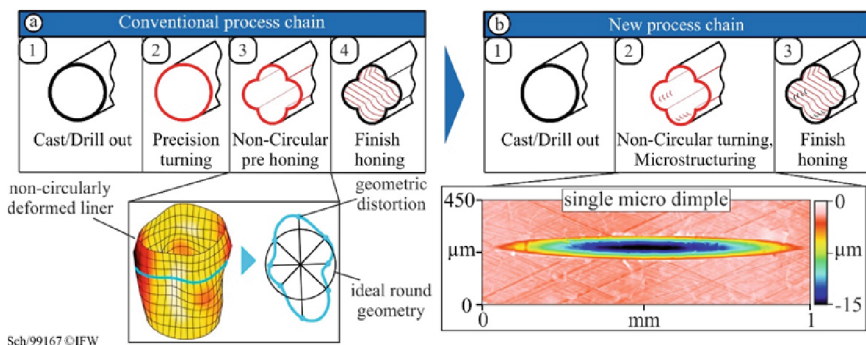
increase resource efficiency in the manufacturing phase of powertrain components. In addition, the use phase is also essential for the overall energy requirements of vehicle components. Within the scope of the project, the cumulative energy demand (CED) [1] was used to calculate the energy saving potentials. Here, the component weight and energy losses (e.g. due to friction) in particular have an impact on the energy requirement. By using innovative manufacturing processes, new types of process chains for resource-efficient production and an energy-optimized use phase for powertrain components can be established. This enables significant CO<sub>2</sub> savings in the automotive industry. The investigated components include cylinder liners, chassis components, drive shafts and vane pumps. In addition, a method for continuous ecological evaluation as well as energy- and resource-oriented control of production is provided. Finally, a digital demonstrator is implemented in order to collect and visualize the gained knowledge for the investigated processes.

## 2 Resource-Efficient Process Chains

### 2.1 Tribologically Optimized Cylinder Liner

Despite the increasing share of electric drives in passenger and freight transport, in certain fields the combustion engine still has to be used for the next years. In particular, this is the case for heavy-duty engines (e.g. shipping, mining or railroad transport). For the energetic optimization of cylinder liners, versatile approaches have been pursued in the past to produce an adapted geometry or topography. Examples are mold honing, coatings or microstructures.

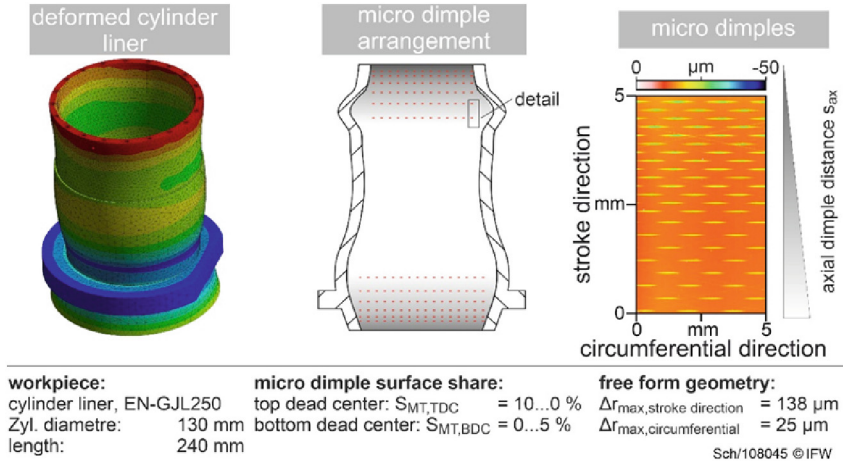
Previous research work realized a reduced friction by form honing and microstructuring [2, 3]. However, shape honing is energy- and resource-intensive and microstructuring could not yet be integrated into a process chain. Therefore, the replacement of form honing by dry non-circular turning is investigated. Furthermore, the integration of microstructuring into the process chain is investigated and a new process chain containing the two processes is set up and shown in Fig. 1. This allows the energetic optimization of cylinder liners and their manufacturing chain.



**Fig. 1.** Process chain variation for the integration of non-circular turning and microstructuring



The approach contains a piezoactuated hybrid tool for non-circular turning and microstructuring. A Non-circularly machined cylinder liner with applied micro dimples is shown in Fig. 2. The design of it is based on advanced simulation methodology [10].



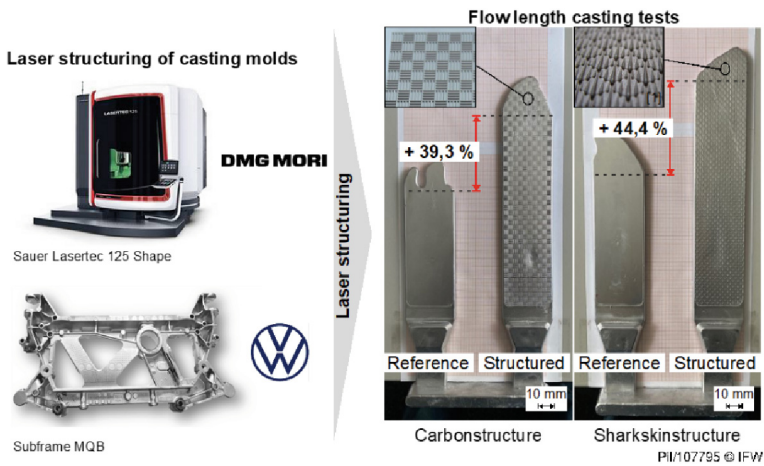
**Fig. 2.** Non-circularly machined cylinder liner with applied micro dimples (left graphic from Alshwawra, following [10])

The cylinder liner is examined at the Institute for Technical Combustion of the Leibniz University Hannover in an engine test rig. The operating range covers a cylinder pressure  $p_{mi} = -2-16$  bar and rotational speed of  $n = 600-1,600\ \text{min}^{-1}$ . The combination of non-circular turning and microstructuring can reduce friction by a maximum of 17%. However, the same maximum friction saving is also achieved by non-circular turning without micro dimples. But, there is a difference in the average over the test's operating range. The average amounts to -9% (non-circular, no micro dimples) and -12% (non-circular, micro dimples). This difference shows that the mode of action of micro-lubrication pockets depends on the load point.

## 2.2 Process Chains for the Manufacturing of Chassis Components

In the context of large-scale production, laser structuring and automated repair welding of casting molds are being investigated as approaches for further increasing the resource efficiency of process chains. By introducing laser structures into the casting molds, chassis components can be manufactured with smaller wall thicknesses and up to 10% less weight [4, 5]. Thus, less energy is required to manufacture the components and a lower weight results in lower CO<sub>2</sub> emissions during the use phase. The energy saving potentials for production and during the service life are determined on the basis of a reference component and its process chain. The insertion of structures into casting molds by means of laser structuring is being researched in order to optimize the application behavior of molds in automotive engineering. To evaluate the influence of the textures on the flow properties of the melt, mold inserts were laser-textured and flow path length casting tests were carried out. The textured patterns carbon and sharkskin were produced.

The results are shown in Fig. 3. The laser structuring results in a significant increase in flow path length compared to unstructured reference molds. For the selected test setup, the flow path length increases by 39.3% for the carbon structure and 44.4% for the sharkskin structure. The significant increase in flow length makes it possible to reduce casting restrictions. As a result, the component weight of the considered subframes can be reduced by up to 10%. This leads to energy savings both in the operation of the component and in the manufacturing phase. The energy savings potential per year for a fleet of 130,000 vehicles is therefore 3,688 MWh. The savings potential can be scaled by the number of castings produced and the number of molds. This means that there is great potential for savings, which will have to be tapped in the future.



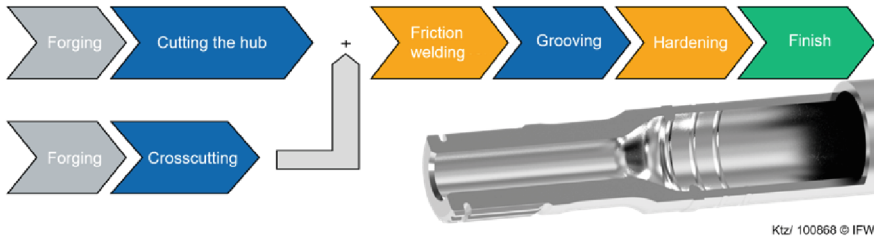
**Fig. 3.** Effect of Laser structuring on the melt flow behavior in casting molds

An automated repair welding and finishing process of the molds offers considerable optimization potentials, e.g. related to the service life of the molds [6]. This reduces the repair costs of the molds and their wear behavior is optimized by targeted mechanical machining. A longer service life of the molds and thus an increase in resource efficiency is the result. The ensuing energy saving potentials are determined and presented on the basis of a case study. With the aid of an automated repair process for casting molds for a hinge bearing, consisting of milling, repair welding and fine machining in a single clamping set up it is possible to plan repairs with reproducible quality and to extend the service life of the casting molds. Automated repair welding of the casting molds is predicted to have the potential to increase service life by 20%. Taking into account the number of units produced for a hinge bearing and the lifetime gain due to repair welding, a forecast energy saving of up to 362.9 MWh is expected.

### 2.3 Process Chain for the Production of Energy Efficient Drive Shafts

Despite the steady advance of e-mobility, drive shafts are still an essential part of the powertrain. Nevertheless, the e-mobility is redefining the requirements for these components. For instance lightweight construction concepts are increasingly being used for all

vehicle components in order to increase the range per charging cycle. For this purpose, a new, primary cutting process chain was defined for the production of shafts and is shown in Fig. 4. The new shaft is a three-part welding hollow component with different material thicknesses. This results in a weight reduction of up to 17% compared to conventional formed lightweight shafts. The weight compared to solid shafts is reduced up to 55% with similar energy consumption in production. A total of up to 2.5 kg can be saved per vehicle. Due to the lower material requirements, the total energy demand can be further reduced.



**Fig. 4.** New process chain for the three-part welded lightweight shaft

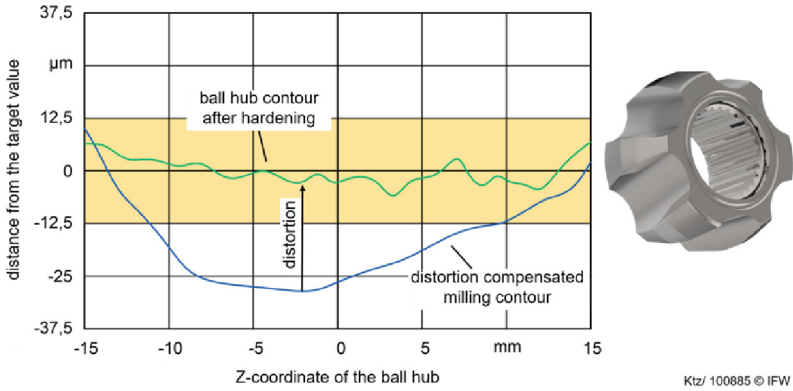
The efficiency of electrically powered vehicles is essential for increasing their range. For this purpose, the use of microstructures in joint housing was investigated. The structure geometry and arrangement was determined by simulation and validated in a swivel bearing test rig. The structural arrangement with 79% reduced friction torque was then moved into the ball raceways of fixed joints housing by means of laser ablation. Afterwards, the structured components were examined on a drive shaft test bench. Within the WLTP test, a reduction in power loss of up to 20% could be determined for ‘run-in’ components. The subsequent endurance tests showed no increased wear of the structured components compared to the series components.

In addition to the energetic consideration of the use phase, the process chains of the drive shaft components were also adjusted and evaluated. An important approach is the elimination of hard machining for the ball hub and joint housing. With a milling process adapted to residual stresses and an inductive hardening strategy designed to minimize the distortion, dimensional deviations can be predicted and compensated during soft machining. The distortion compensation of the ball tracks is shown in Fig. 5.

The shortened process chain requires 12% less energy to manufacture a joint housing and 20% less energy to manufacture a ball hub. Fluctuations within the process chain are counteracted by an automated cascade control. The optimization of the drive shaft achieved in this way offers the potential, based on the annual production figures and mileage of the vehicles of the Volkswagen Group, to save about 3,200 MWh of energy per year in production and about 2,000,000 t of CO<sub>2</sub> in the use phase.

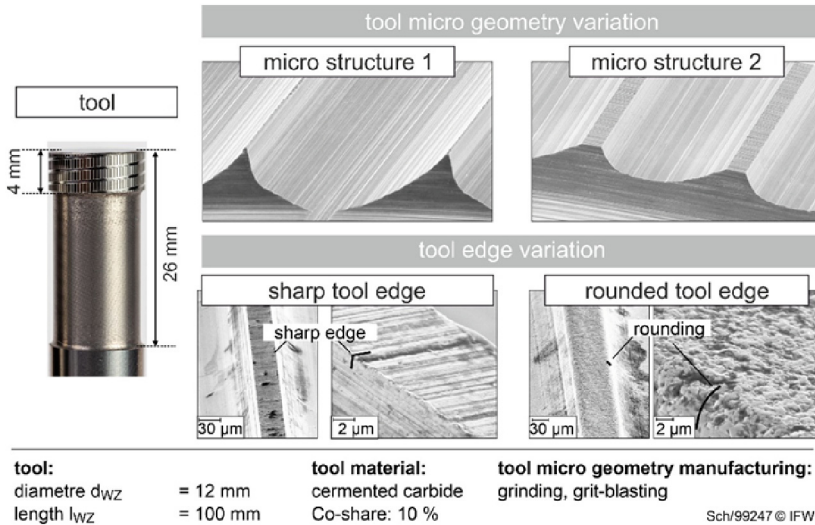
## 2.4 Tribologically Adapted Vane Pump

The vane pump is required to provide the gear box with pressurized hydraulic oil. As it is operated at the engine’s rotational speed, the boundary conditions are demanding.



**Fig. 5.** Distortion compensation of the ball tracks using the example of the ball hub

The moving components inside the pump are subject to high pressures of up to  $p_{max} = 22$  bar, rotational speed of up to  $n_{pump} = 9,000 \text{ min}^{-1}$  and temperatures of up to  $\theta = 70 \text{ }^\circ\text{C}$  [7]. One of the major losses in vane pumps is friction between the vanes and the inner cam ring. This tribological contact zone is aimed to be improved by the application of micro dimples. These are generated using an embossing process with a biaxial rolling embossing kinematic. Therefore, cemented carbide shafts were microstructured on the shell surface by grinding. The manufactured tool is shown in Fig. 6. As these negative micro dimples are on the outside of the cylindrical tool, a good accessibility is given. The tool is used to generate micro dimples on the inner surface of the cam ring.



**Fig. 6.** Tool micro geometry for rolling embossing

Micro dimples with a width of  $w_i = 30 \mu\text{m}$  and a depth of  $d_i = 15 \mu\text{m}$  have successfully been manufactured on the inner ring of a ball bearing. Due to the workpiece's and tool's elastic behaviour the micro dimples are smaller than the size of the embossing element, which has to be taken into account in the process. As a next step the adapted vane pumps are tested on a vane pump test rig. Here, the flow rate, the temperature and flow losses will be evaluated in comparison to vane pumps without micro dimples.

## 2.5 Energy-Efficient Production Planning

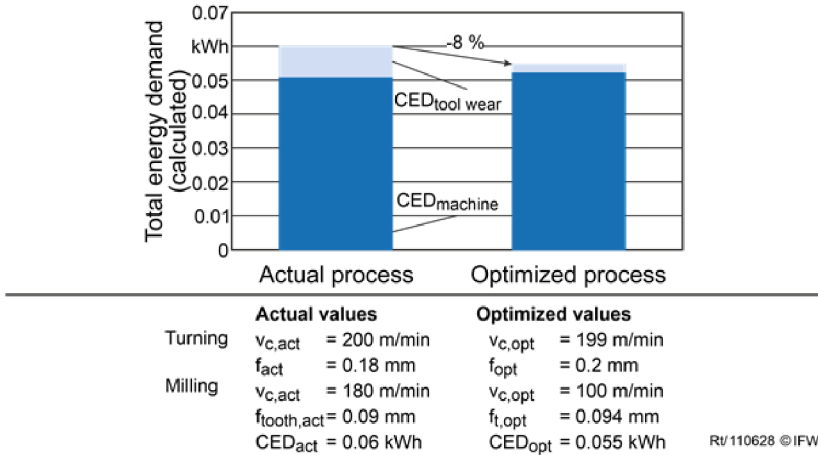
An additional savings potential, is offered by energy-efficient production planning. By optimizing the production system with regard to the target variable energy (e.g. kWh/part), it is possible to calculate ecological process parameters, which were able to demonstrate a further savings effect. Based on previous approaches to the ecological evaluation of machining processes, an approach was developed that enables the ecological evaluation and optimization of process chains [8]. For this purpose, the productivity of process chains must be taken into account. In line with the overall equipment effectiveness (OEE) [9], the productivity is assessed based on quality and capacity utilization. The scrap rate (SR) is selected as KPI for quality, the capacity utilization is assessed on the basis of idle times ( $E_I$ ), like production downtimes. The combination of productivity and CED as well as the consideration of a number  $m$  of produced products results in the following indicator  $CED_{PPC}$ .

$$CED_{PPC} = \frac{1}{m} \left( (1 + SR) \sum_{j=1}^m \left( \sum_{i=1}^n CED_{i,j} + \sum_{i=1}^n E_{I,i,j} \right) \right) \quad (1)$$

As part of the evaluation of the developed procedure, a tool for the ecological assessment and optimization of process chains was developed and implemented as a prototype in a real process chain of an axle journal. Based on online machine data (e.g. feed rate, spindle speed) and manual inputs (e.g. cycle time, roughness requirement), an ecological evaluation of the process is possible. After calculating the component's energy footprint and optimizing the process parameters, extensive information regarding actual and target data (e.g. including engagement conditions, process time, energy requirements) is stored in a component-related ecological database of the production system. The calculation of the energy shares is done according to [8]. With the application of the developed procedure, an additional saving of 8% could be achieved for through the energy-efficient planning of process chains. Figure 7 shows the energy savings achieved and the corresponding process parameters.

## 2.6 Digital Demonstrator

For final consideration and visualization of the knowledge gained and occurred advantages of the components, a digital demonstrator was created. Thereby, the efficiencies of the powertrain and the energy, which must be expend for production, were processed and displayed graphically. The savings of the developed components during the lifetime were worked out and used for a comprehensive consideration over the period. Comprehensive analyzes were conducted and provided for the consideration of energy consumption. In



**Fig. 7.** Presentation of the test results for hard machining of the axle journal on the CTV 250 DF

addition, for the demonstrator a calculation of the CO<sub>2</sub> savings was implemented. The demonstrator was developed with MATLAB, since large data collections can be handled mathematically and a conversion to a stand-alone application can be realized. The MATLAB App Designer software is used to graphically process the results. The user has the opportunity to view the individual components in detail and to see the individual energy consumption from production. It is also possible to adjust the data sets and analyze the effects on the overall energy consumption. The boundary conditions of the expected service life can be adjusted. With the demonstrator, a tool was developed with which an overall view of the project and future technical innovations can be shown.

### 3 Conclusion

In this paper process chains for machining and manufacturing cylinder liners, casting molds, drive shafts and vane pumps were investigated and optimized. A method for energy-efficient production planning and a virtual demonstrator for visualization and output of the results were developed. These enable the process chains to be planned, controlled and monitored in terms of resource efficiency. In the project “Powertrain 2025 - Energy-efficient process chains for the production of a friction-, weight- and service life-optimized powertrain”, funded by the Federal Ministry for Economic Affairs and Climate Action, significant energy-saving potential was identified both in the production phase and in the service life phase of powertrain components. The research results and measures presented resulted in a weight reduction of the powertrain components of 4.5 kg per vehicle and a potential annual energy saving of 13,073 MWh.

With the method for energy-efficient production planning and the digital demonstrator, it is possible to evaluate and optimize the energy and resource efficiency of the process chains. This approach can be transferred and applied to further process chains.

## References

1. VDI Society Energy and Environment: Cumulative energy demand (KEA) - Terms, definitions, methods of calculation, VDI 4600. Beuth Verlag GmbH (2012)
2. Landerl, C., Rüllicke, M., Spanring, D., Schmuck-Soldan, S.: The next generation gasoline engine family from BMW. *MTZ Worldwide* **79**(3), 40–47 (2018)
3. Kaestner, J.: Methode zur spanenden Herstellung reibungsminimierender Mikroschmier-taschen. Dr.-Ing. Diss., Leibniz Universität Hannover (2013)
4. Knorr, S.R.: Einfluss einer strukturierten Kokillenoberfläche auf das Fließ- und Form-füllungsvermögen beim Aluminiumgießen. Dr.-Ing. Diss., Otto-von-Guericke-Universität Magdeburg (2018)
5. Gierth, S., Knorr, S., Beganovic, T., Findeisen, S.: Schwerkraftkokillen-gießen mit strukturierten Kokillenoberflächen, Teil 2: innovative Strukturen. *Giesserei* **103**(5), 24–31 (2016)
6. Bennett, J., et al.: Repairing automotive dies with directed energy deposition: industrial application and life cycle analysis. *J. Manuf. Sci. Eng.* **141**(2) (2019)
7. Inaguma, Y., Hibi, A.: Vane pump theory for mechanical efficiency. *Proc. Inst. Mech. Eng. Part C J. Mech. Eng. Sci.* **219**(11), 1.269–1.278 (2005)
8. Denkena, B., Dittrich, M.-A., Onken, L.: Environmental evaluation of process chains. *Procedia CIRP* **2020**(88), 265–269 (2020)
9. ISO International Organization for Standardization. Automation systems and integration - Key performance indicators (KPIs) for manufacturing operations management - Part 2: Definitions and descriptions, ISO 22400-2:2014(E) (2014)
10. Alshawra, A., Pohlmann-Tasche, F., Stelljes, F., Dinkelacker, F.: Effect of freeform Honing on the geometrical performance of the cylinder liner – numerical study. *SAE Int. J. Engines* **16**(4), (2023)







**Open Access** This chapter is licensed under the terms of the Creative Commons Attribution 4.0 International License (<http://creativecommons.org/licenses/by/4.0/>), which permits use, sharing, adaptation, distribution and reproduction in any medium or format, as long as you give appropriate credit to the original author(s) and the source, provide a link to the Creative Commons license and indicate if changes were made.

The images or other third party material in this chapter are included in the chapter's Creative Commons license, unless indicated otherwise in a credit line to the material. If material is not included in the chapter's Creative Commons license and your intended use is not permitted by statutory regulation or exceeds the permitted use, you will need to obtain permission directly from the copyright holder.





# Optimizing Product Life Cycle Systems for Manufacturing in a Circular Economy

Buddhika M. Hapuwatte<sup>(✉)</sup> , Nehika Mathur , Noah Last , Vincenzo Ferrero ,  
Maya Reslan , and K. C. Morris 

National Institute of Standards and Technology (NIST), Gaithersburg, MD 20899, USA  
buddhika.hapuwatte@nist.gov

**Abstract.** Global population growth and increasing resource scarcity are necessitating sustainable manufacturing and circular economy (CE) practices. These practices require the decisions made at each product life cycle (PLC) stage consider sustainability and circularity implications. We propose PLC system level optimization to identify the most favorable choices, instead of siloed individual PLC stage-specific optimizations. This should yield better circularity by permitting manufacturers to take a more holistic view and identify the areas of highest impact across the PLC. This paper presents initial work towards building a PLC system optimization framework. From an initial review of current circularity metrics, we identify metrics that are suitable for forming the optimization objectives. Second, we identify decision variables available to manufacturers across the PLC that are useful in optimizing the entire system's circularity and sustainability. Finally, we identify limitations of current metrics, and discuss major challenges and potential solutions to PLC system optimization problems.

**Keywords:** Circular economy · Sustainable manufacturing · Optimization · Metrics · Product life cycle

## 1 Introduction

Traditional manufacturing exploits economies of scale to mass-produce commodities and meet growing global demands to improve human quality of life. Ironically, the result has been economic considerations take priority over environmental and social ones, thus degrading the environment and compromising quality of life [1]. Alternatively, sustainable development and circular economy (CE) are introduced to enabled the *triple bottom line* (TBL) thinking—the balance between economic, environmental, and social factors that accounts for temporal and spatial parameters [2]. CE more specifically focuses on decoupling economic growth from virgin resource consumption [2].

A system is a collection of elements that work together towards a goal. A CE system orchestrates a variety of stakeholders (incl. manufacturers) that use and manage resources and manufacture products. A *product life cycle* (PLC)-wide [3] CE system is a system viewpoint intended to encompass circularity and sustainability concerns over the PLC stages of *pre-manufacturing*, *manufacturing*, *use*, and *post-use*. In this work, we focus on



identifying the properties and metrics that make it possible to optimize from this more encompassing viewpoint.

This paper makes two main contributions. First, it provides an initial review of current circularity metrics and identifies metrics for comprehensive PLC evaluation. Equitable quantitative metrics are critical to form objectives of the proposed PLC CE system optimization. Second, we identify potential decision variables available to manufacturers throughout the PLC that help enhance and optimize the circularity and sustainability of entire PLC. Rather than the current siloed approach of optimizing several elements of each PLC stage separately, a PLC system optimization can improve circularity by first focusing on high impact areas [4].

## 2 Background

The literature presented below proposes metrics for measuring circularity at different stages of the PLC. We considered both recent literature on CE and prior work on sustainable manufacturing. In a recent paper which reviews 114 definitions for CE, Kirchherr et al. [5] raised two major points: 1) only a few definitions address the totality of the TBL and 2) operational level subdivisions are useful for addressing CE. TBL is a foundational tenant of sustainable manufacturing [2]. Yet, several studies flag that TBL is inadequately addressed in CE [5, 6]. While Linder et al. [7] argued circularity should focus exclusively on resource circulation, since higher circularity does not mean better sustainability [8], others recommend [5, 6, 8] complementing circularity with TBL to ensure that sustainability—the goal of CE—is achieved.

Saidani et al. [9] in one of the very few publications on product circularity optimization highlighted the importance of considering both circularity and sustainability metrics, especially during product design, to reveal possible trade-offs. Given this lack of literature on optimizing the PLC for circularity, we review closely relevant literature discussing sustainability optimization at different PLC stages (Sect. 2.1) and the evaluation of circularity in the product context using metrics (Sect. 2.2). Section 3 discusses the integration of decision variables identified in sustainability optimizations with circularity metrics to form PLC system optimizations for CE.

### 2.1 Current Literature on Optimization for Manufacturing CE

This review summarizes noteworthy literature on PLC activities with a manufacturing-centric point-of-view as described in [2]. Pre-manufacturing stage is broken down to *design* and *acquire material*; manufacturing stage is narrowed to *production*; and post-use stage focuses on *recovery* for circularity. *Acquire material* and *recovery* are considered together for their close relationships in CE. While important, *use* is beyond the scope of this paper's manufacturing-centric view.

**Design:** Product design disproportionately influences a majority of a product's environmental impact and is crucial in a CE [2]. *Design for sustainability* (DfS) considers environmental impact during design and is the precursor to design for CE. In a recent study Hapuwatte et al. introduced a metrics-based CE product design evaluation framework [2] consisting of 90+ metrics, to be parametrically modeled. Others explored DfS

optimization to identify metric models and constraints relevant to CE. For example, Hapuwatte et al. [10] optimized the sustainability performance of multi-generational products by using design configuration choices based on TBL objectives: minimize greenhouse gas (GHG) emissions, maximize profit, and maximize product functionality. Other studies optimized product design by considering trade-offs between life cycle cost and environmental impact [11] and disassemblability [12]. These models are useful for establishing CE metrics linked to other PLC stages.

**Acquire Materials and End-of-use (EoU) Recovery:** Optimization can be extremely useful for balancing TBL trade-offs [4]. Most work focuses on economic and environmental dimensions. Material acquisition and recovery must be planned considering the range of recovery options—reuse, remanufacturing, recycling, energy recovery, and landfilling [3]. For example, Jiang et al.'s optimization models minimize the environmental impact of remanufacturing [13]. Other studies have explored optimizing disassembly lines from the point of view of profit, disassembly time, and energy consumption [14, 15]. Mathur et al. [16] used a hybrid optimization approach to balance economic and environmental metrics in the context of EoU photovoltaics. These studies flag a lack of standardized methods for determining 1) the ease of EoU material recovery and 2) the suitability of recovered EoU materials as feedstock. Therefore, metrics on topics such as *product disassemblability and modularity*, and *material composition and quality* are needed.

**Production:** Many production management decisions that tend to have large environmental impact (e.g., manufacturing processes, materials used) now increasingly take into account the sustainability impacts [2]. To balance competing interests, several studies presented the use of optimization models. Atabaki et al. [17] discussed production optimization for CE by considering the decision variables *supplier and location selection, transportation mode, assembly methods, and recovery decisions* and the objectives *cost, GHG emissions, and energy consumption*. Others modeled manufacturing process and process-condition selection by considering *cost, GHG emissions, and energy use* [18]. In production planning for CE, Hapuwatte and Jawahir called for considering the entire PLC to avoid TBL burden shifting to other PLC stages [2]. Metrics for production and manufacturing processes are often dependent on the particulars of the individual processes. Work from NIST [19] defined a procedure for selecting process-specific metrics for improving sustainable performance.

In addition to the metrics themselves, it is important to consider the types of classifications available for manufacturing-focused circularity metrics. Recently, Boyer et al. [20] discussed the importance of evaluating the product level circularity in three dimensions: *recirculation* (composition of secondary material), *utilization* (intensity of product usage), and *endurance* (product's ability to retain its value over time). In another comprehensive review [21] discussing CE and its quantification using circularity metrics, Parchomenko presented three major *circularity-metrics clusters* similar to Boyer et al.'s dimensions. The main difference is that Parchomenko combined *utilization* and *endurance* in a *product-centric cluster* and included a separate *material and stock flows cluster*. Their analysis also identified metrics that combine multiple clusters (e.g., Material Circularity Indicator). We use Boyer et al.'s dimensions for our discussion in Sect. 3.2 because it covers the entire PLC and provides more distinct categorization. Metrics capturing *recirculation* dimensions are important. In fact, most circularity metrics focuses

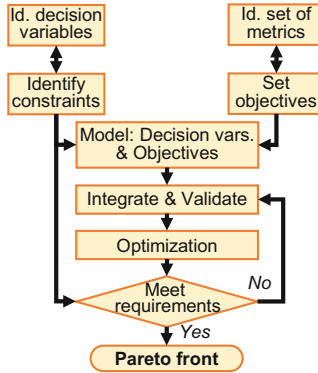


Fig. 1. PLC System Optimization

on this *inherent circularity* (i.e., recirculation of resources) rather than its TBL consequences [9]. Therefore, in parallel to these metrics, it is essential to consider the metrics that address the TBL impacts.

### 3 PLC System Optimization in a CE

PLC system optimization for a CE requires two components: a framework for performing the optimization and quantitative data for representing the system.

To effectively optimize a PLC system, one needs to identify and quantify the decision variables, constraints, and objectives. We do so from the manufacturer’s perspective. Concerns of other stakeholders (e.g., customers, society) are integrated through constraints on the optimization problem. Figure 1 illustrates the basic steps for building a systems optimization framework. Table 1 identifies the major types of manufacturing decisions at each PLC stage. These can be used to determine decision variables in the PLC-system optimization. The decision types were identified from the literature on manufacturing-focused optimizations in Sect. 2.1.

Since this optimization requires quantitative measurements of the PLC system, the circularity metrics can form that basis. Circularity metrics can be drawn from recent reviews in Sect. 2 and classified. Table 2 summarizes several metrics that are more prominently used in literature; they also represent all three of Boyer et al.’s [20] circularity dimensions (recirculation, utilization, and endurance). As depicted in Fig. 1, an interactive process is used to identify metrics and form objectives for a multi-objective optimization. Table 2 details how extensively the metrics cover each PLC stage, as is needed to ensure a comprehensive evaluation. Table 2 lists the sub-elements of each metric considered at PLC-level. The analysis uncovers some models necessary to relate the manufacturing decisions in Table 1 with the associated optimization objectives. Figure 2 illustrates the complex set of such models, using two metrics as examples. While these models need to be developed (or extended from current TBL optimization work) and validated, understanding the possibilities will help with building a PLC-level optimization framework. A Fig. 2-like diagram is useful for determining a set of metrics-based

**Table 1.** Decision variables for manufacturers at different PLC activity

PLC activity	Decision Types	Examples of Decisions
Design	Design decisions	Product features (dimensions, mass), Modularity, Design config., Disassemblability, Sustainability
Acquire materials and EoU recovery	Material sourcing dec	Material composition/quality, Collection incentives & ratio, Recyclable/Reused/Remanufactured content
	Material efficiency dec	Recycling efficiency
Production	Process decisions	Process-type selection, Process conditions
	Production decisions	Supplier/production location, Scheduling, Logistics
Use	Utility decisions	Product lifetime/reliability, Functionality/efficiency
	Service decisions	Maintenance/servicing, Product-service model

objectives to find optimal decisions at all levels. Considering the entire PLC as a *system* allows the manufacturer to examine alternative decisions and identify the best option. For example, conventionally to improve the manufacturing circularity of a plastic container, the manufacturing process parameters may be tried to optimize limiting scrap or improving efficiency. With a system view, optimization can consider product design changes necessary to improve material use as well allow altering material composition to higher recycled content.

A considerable number of sub-elements in Table 2 focus on the *recirculation* dimension. Likewise, the metrics in Table 1 are heavily weighted toward decisions in *material acquisition/EoU recovery* and *design* (decisions that influence material options) and highlight the concerns raised in prior publications [20, 21] that current research has an unbalanced view of circularity dimensions. Many constraints and deciding factors of the manufacturing decisions in Table 1 are based on TBL concerns and are predominantly economic (i.e., cost) and environmental (i.e., regulation and value proposition), but rarely social factors. Given the importance of TBL for businesses, incorporating a broad coverage of TBL metrics when optimizing the PLC system is vital (see Sect. 2.1).

### 3.1 Challenges and Potential Solutions

While the feasibility of applying optimization to improve outcomes has been shown, several factors challenge such models' robustness and suggest a need for standards and guidelines to enable the application of this technology. As Sect. 3.2 identified, modeling PLC decisions relies on many decision variables and constraints. Quantifying the outcomes of those decisions using metrics requires integration of multiple siloed

**Table 2.** Prominent quantitative circularity metrics and the sub-elements they use to consider for each PLC-stage activity

Metric	Design	Acquire materials/Recovery	Production	Use	Sustainability TBL
Material Circularity Indicator (MCI) [22]	<ul style="list-style-type: none"> <li>Product mass (M)</li> </ul>	<ul style="list-style-type: none"> <li>Virgin feedstock (V)</li> <li>Feed recycling efficiency (<math>E_F</math>)</li> <li>Unrecoverable waste (W)</li> <li>Energy recovered (<math>E_R</math>)</li> </ul>	<ul style="list-style-type: none"> <li>Recycling efficiency of component production (<math>E_C</math>)</li> <li>Energy recovery efficiency (<math>E_E</math>)</li> </ul>	<ul style="list-style-type: none"> <li>Utility: Product lifetime (L)</li> <li>Utility: Intensity of use (U)</li> </ul>	(No direct consideration; other than material efficiency)
Product-Level Circularity Metric (PLCM) [7]	<ul style="list-style-type: none"> <li>Indirectly: Number of components</li> </ul>	<ul style="list-style-type: none"> <li>Cost of all material</li> <li>Cost of all components</li> <li>EoU material &amp; compon. Price</li> <li>Remanufacturing cost</li> </ul>	<ul style="list-style-type: none"> <li>Value added during production</li> </ul>	(Not considered)	Economic costs and values are considered
Circularity Index (CI) [23]	<ul style="list-style-type: none"> <li>Indirectly informs the availability and feasibility of secondary feedstock</li> </ul>	<ul style="list-style-type: none"> <li>Material stocks &amp; dissipative losses in recovery proces. (<math>\alpha</math>)</li> <li>Recovered material quality &amp; energy requirements (<math>\beta</math>)</li> </ul>	(Not considered)	(Not considered)	(No direct consideration; other than material losses/degradation, energy intensity)
Sustainability Performance Indicators (SPI) [24]	<ul style="list-style-type: none"> <li>Proportion of linear material flow</li> <li>Product Mass (M)</li> <li>Number of components (n)</li> </ul>	<ul style="list-style-type: none"> <li>Virgin feedstock (<math>V_j</math>)</li> <li>Waste from production of recycled feedstock (<math>W_{jf}</math>)</li> <li>Waste from recyc. Parts (<math>W_{Cj}</math>)</li> <li>Reusable component (<math>M_{ri}</math>)</li> </ul>	<ul style="list-style-type: none"> <li>Unrecoverable waste (<math>W_j</math>)</li> <li>Efficiency of recycling process (<math>E_i</math>)</li> </ul>	<ul style="list-style-type: none"> <li>Number of times product is reused (<math>k_i</math>)</li> </ul>	<ul style="list-style-type: none"> <li>Considers “Design for Sustainability” framework</li> </ul>
Ease of disassembly metric (eDiM) [25]	<ul style="list-style-type: none"> <li>Number of product manipulations</li> <li>Num. of connectors</li> <li>Identifiability (qualitative)</li> </ul>	<ul style="list-style-type: none"> <li>Inefficiency rate</li> <li>Tool change time</li> <li>Identifying time</li> <li>Manipulation time</li> <li>Removing time</li> </ul>	<ul style="list-style-type: none"> <li>Component disassembly sequence</li> <li>Connector disassembly sequence</li> </ul>	(Not considered)	<ul style="list-style-type: none"> <li>Considers “Ecodesign” requirements</li> </ul>

modeling approaches each with differing models, metrics, and data. Standardization of circularity metrics and measurement frameworks will enable integration as well as consistent evaluations [20].

Standardization will be necessary for comprehensibility and usability between PLC stages and the extended supply chain. Even within the metrics in Table 2, some similarly named parameters are defined differently. Most circularity and sustainability metrics identified above do not consider the *dynamic* nature of CE systems, focusing instead

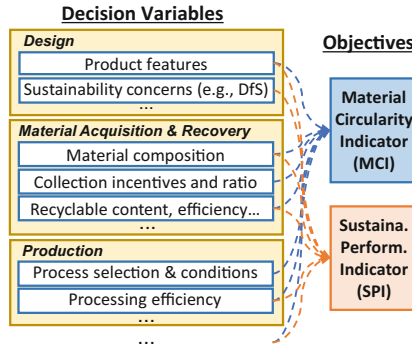


Fig. 2. Relating the decision variables to the metrics (a partial list)

on “snapshots in time” of a production. Certain metric sub-elements (e.g., *virgin feed-stock used*, *collection ratio*) can significantly change over multiple productions. Thus, temporal variations are vital to PLC system optimization. A potential solution [26] had employed *demand variation* to model certain elements’ temporal changes and suggested use of metrics that consider the entire production timeline to overcome this challenge. In addition, data uncertainty is especially challenging given the number of parameters and sub-models involved in setting up PLC optimization problems. Prior CE production modeling [17] has illustrated techniques to cope with both *randomness* and *epistemic* uncertainty to build robust optimization models. Additionally, to capture these complexities of integrating multiple circularity metrics, others suggest the use of complex system sciences [8].

## 4 Conclusions

A *system* viewpoint is necessary to make manufacturing decisions in a CE. Given the proliferation and conflicting nature of these decisions and their outcomes, multi-objective optimization is needed to identify optimal choices, considering the trade-offs.

In this paper, we discussed the fundamental considerations for developing PLC system optimization techniques in a CE. We identify potential quantitative metrics that can be used to form the optimization-objectives. Most CE metrics focus on *recirculation* dimension of circularity and exhibit a general lack of consideration for TBL. Thus, the PLC system optimization must account for multiple objectives based on complementing metrics. We also present different types of manufacturing decisions across the PLC and analyze the relationship of the circularity metrics to those decisions. Several prior works provide potential solutions to overcome the challenges in model integration, accounting for the dynamic nature of CE, and data uncertainty in system optimization.

While this work provides an essential first step in realizing PLC system optimization, more work is needed to develop models to relate the decision variables to metrics presented. Although modeling will be specific to each application, studying existing methods can lead to a more standard approach to building the necessary sub-models of PLC. Standardization will especially benefit integration of sub-models into a PLC

system-level model. Such a system-level optimization tool can provide crucial decision support for product designers and enable a more effective CE.

## References

1. Geissdoerfer, M., Savaget, P., Bocken, N.M.P., et al.: The circular economy – a new sustainability paradigm? *J. Clean. Prod.* **143**, 757–768 (2017)
2. Hapuwatte, B.M., Jawahir, I.S.: Closed-loop sustainable product design for circular economy. *J. Ind. Ecol.* **25**, 1430–1446 (2021)
3. Reslan, M., Last, N., Mathur, N., et al.: Circular economy: a product life cycle perspective on engineering and manufacturing practices. *Procedia CIRP.* **105**, 851–858 (2022)
4. Avraamidou, S., Baratsas, S.G., Tian, Y., et al.: Circular economy - a challenge and an opportunity for process systems engineering. *Comput. Chem. Eng.* **133**, 106629 (2020)
5. Kirchherr, J., Reike, D., Hekkert, M.: Conceptualizing the circular economy: an analysis of 114 definitions. *Resour. Conserv. Recycl.* **127**, 221–232 (2017)
6. de Oliveira, C.T., Dantas, T.E.T., Soares, S.R.: Nano and micro level circular economy indicators: assisting decision-makers in circularity assessments. *Sustain. Prod. Consum.* **26**, 455–468 (2021)
7. Linder, M., Sarasini, S., van Loon, P.: A metric for quantifying product-level circularity: product-level circularity metric. *J. Ind. Ecol.* **21**, 545–558 (2017)
8. Walzberg, J., Lonca, G., Hanes, R.J., et al.: Do we need a new sustainability assessment method for the circular economy? A Critical Literature Review. *Front. Sustain.* **1**, 620047 (2021)
9. Saidani, M., Kim, H., Yannou, B., et al.: Framing product circularity performance for optimized green profit. In: ASME 2019 International Design Engineering Technical Conferences and Computers and Information in Engineering Conference IDETC/CIE2019, Anaheim, California, United States (2019)
10. Hapuwatte, B.M., Badurdeen, F., Bagh, A., et al.: Optimizing sustainability performance through component commonality for multi-generational products. *Resour. Conserv. Recycl.* **180**, 105999 (2022)
11. Ameli, M., Mansour, S., Ahmadi-Javid, A.: A sustainable method for optimizing product design with trade-off between life cycle cost and environmental impact. *Environ. Dev. Sustain.* **19**(6), 2443–2456 (2016). <https://doi.org/10.1007/s10668-016-9864-x>
12. Chiu, M.-C., Chang, C.-H., Chen, Y.-T., et al.: Redesign for sustainability and assemblability using particle swarm optimization method. *J. Ind. Prod. Eng.* **33**, 103–113 (2016)
13. Jiang, H., Xu, L., Li, J., et al.: Energy management and component sizing for a fuel cell/battery/supercapacitor hybrid powertrain based on two-dimensional optimization algorithms. *Energy* **177**, 386–396 (2019)
14. Ren, Y., Meng, L., Zhang, C., et al.: An efficient metaheuristics for a sequence-dependent disassembly planning. *J. Clean. Prod.* **245**, 118644 (2020)
15. Wang, W., Zhou, X., Tian, G., et al.: Multi-objective low-carbon hybrid flow shop scheduling via an improved teaching-learning-based optimization algorithm. *Sci. Iran.* (2022)
16. Mathur, N., Sutherland, J.W., Singh, S.: A study on end of life photovoltaics as a model for developing industrial synergistic networks. *J. Remanufact.* (2022)
17. Atabaki, M.S., Mohammadi, M., Naderi, B.: New robust optimization models for closed-loop supply chain of durable products: towards a circular economy. *Comput. Ind. Eng.* **146**, 106520 (2020)
18. Lu, T., Jawahir, I.S.: Metrics-based sustainability evaluation of cryogenic machining. *Procedia CIRP* **29**, 520–525 (2015)

19. Kibira, D., Brundage, M.P., Feng, S., et al.: Procedure for selecting key performance indicators for sustainable manufacturing. *J. Manuf. Sci. Eng.* **140** (2017)
20. Boyer, R.H.W., Mellquist, A.-C., Williander, M., et al.: Three-dimensional product circularity. *J. Ind. Ecol.* **25**, 824–833 (2021)
21. Parchomenko, A., Nelen, D., Gillabel, J., et al.: Measuring the circular economy - A multiple correspondence analysis of 63 metrics. *J. Clean. Prod.* **210**, 200–216 (2019)
22. Ellen MacArthur Foundation: *Circularity Indicators: Methodology - An Approach to Measuring Circularity*. Ellen MacArthur Foundation (2019)
23. Cullen, J.M.: Circular economy: theoretical benchmark or perpetual motion machine? *J. Ind. Ecol.* **21**, 483–486 (2017)
24. Mesa, J., Esparragoza, I., Maury, H.: Developing a set of sustainability indicators for product families based on the circular economy model. *J. Clean. Prod.* **196**, 1429–1442 (2018)
25. Vanegas, P., Peeters, J.R., Cattrysse, D., et al.: Ease of disassembly of products to support circular economy strategies. *Resour. Conserv. Recycl.* **135**, 323–334 (2018)
26. Hapuwatte, B.M., SeEVERS, K.D., Jawahir, I.S.: Metrics-based dynamic product sustainability performance evaluation for advancing circular economy. *J. Manuf. Syst.* **64**, 275–287 (2022)

**Open Access** This chapter is licensed under the terms of the Creative Commons Attribution 4.0 International License (<http://creativecommons.org/licenses/by/4.0/>), which permits use, sharing, adaptation, distribution and reproduction in any medium or format, as long as you give appropriate credit to the original author(s) and the source, provide a link to the Creative Commons license and indicate if changes were made.

The images or other third party material in this chapter are included in the chapter's Creative Commons license, unless indicated otherwise in a credit line to the material. If material is not included in the chapter's Creative Commons license and your intended use is not permitted by statutory regulation or exceeds the permitted use, you will need to obtain permission directly from the copyright holder.





# **Energy Efficiency**



# Development of a Holistic Framework for Identifying Energy Efficiency Potentials of Production Machines

Borys Ioshchikhes<sup>(✉)</sup> , Daniel Piendl , Henrik Schmitz, Jasper Heiland,  
and Matthias Weigold 

Institute of Production Management, Technology and Machine Tools (PTW), Technical  
University of Darmstadt, Otto-Berndt-Str. 2, 64287 Darmstadt, Germany  
`b.ioshchikhes@ptw.tu-darmstadt.de`

**Abstract.** A prerequisite to identify energy efficiency potentials and to improve energy efficiency is the measurement and analysis of the energy demand. However, in industrial practice, approaches to identify energy efficiency measures of production machines are associated with high costs for metering equipment and time consuming analysis requiring expertise. Against this background, this paper describes a comprehensive and cost-efficient framework from acquisition to analysis of energy data to serve as a starting point to increase energy efficiency in manufacturing. For this purpose, an energy transparency and analysis system is being developed that can measure, record and analyze electrical quantities. The validity of the data acquisition can be verified by utilizing a Raspberry Pi as a low-cost edge analyzer device. Measurement data is stored with associated metadata in a SQLite database for subsequent processing in a Python-based web application, in which machine learning algorithms can be deployed. The algorithms can be used to process vast amounts of data and to provide a basis for calculating energy performance indicators to reveal energy efficiency potentials. The overall workflow is validated using a lathe and a cleaning machine within the ETA Research Factory at the Technical University of Darmstadt.

**Keywords:** energy transparency · data acquisition · sustainable manufacturing

## 1 Introduction

Electricity consumption by the industrial sector accounted for 33% of total industrial energy consumption in the European Union in 2020 [1]. Moreover, companies are facing continuously rising electricity costs, forcing them to treat electric energy as a resource that must be strategically planned and managed. A prerequisite to identify energy efficiency potentials and to increase energy efficiency without compromising production targets is the measurement and analysis of the energy demand [2]. Methods to identify energy efficiency measures of production machines are associated with high costs for metering equipment and time consuming analysis requiring expertise [2, 3]. In industrial practice companies tend to underestimate the monetary potential of investments in

energy efficiency and therefore often lack energy measurements on machine and component level [4]. A further significant barrier for identifying a large number of energy efficiency measures are limited in-house skills for processing and using measurement data [5].

Various scientific approaches, ranging from simulations to analysis of measurement data and expert knowledge, allow the identification of possible energy efficiency measures [6, 7]. Easy to apply approaches are presented by [6, 8] and [9] but either do not offer sufficient accuracy or are limited to individual machine types such as machine tools. Furthermore, in existing approaches such as [6] and [3], data acquisition and analysis are performed separately in respect to time using systems that are independent of each other. As a result, time-consuming data export and data preparation from one system are required before data analysis can be applied on another system. Against this background, this paper presents a cost-efficient holistic framework to acquire and analyze energy data as an essential step in improving the energy efficiency of production machines.

Following the introduction, Sect. 2 reviews the background, including production machines, as well as the measurement and analysis of electrical data. The overall framework is presented along with the energy transparency and analysis system (ETAS) in Sect. 3, followed by case studies on two machines in Sect. 4. Finally, Sect. 5 concludes this paper with the summary and outlook.

### Nomenclature

ETAS	energy transparency and analysis system
I	current
L	phase
NPTF	non-production time factor
P	active power
RPi	Raspberry Pi
SD	Secure Digital Memory Card
U	voltage
$\varphi$	phase angle

### Indices

N	neutral
tot	total

## 2 Background

### 2.1 Production Machines

In the context of this paper, the characterization of machine tools of [10] and [11] is extended to cover additional production machines. Based on this, production machines can be considered as an assembly of multiple electrical components that are required in their entirety to execute a specific production task [10, 11]. The energetic behavior of a production machine is therefore determined by the power consumption of its individual components and their interaction [10]. Thus, to identify energy efficiency potentials of

production machines, it is necessary to measure and analyze the energy input and its distribution among the individual components.

## 2.2 Electricity Measurement

By measuring voltage and current in three-phase and single-phase networks as a function of time, all other specific information can be derived mathematically [12]. In a general three-phase network with alternating current, the total active power, which is a significant parameter for the energetic evaluation of electric machines, is calculated by using the following equation.

$$P_{\text{tot}} = \sum_{n=1}^3 P_n = \sum_{n=1}^3 U_{Nn} I_n \cos \varphi_n \quad (1)$$

where  $\varphi_n$  is the phase angle between the voltage  $U_{Nn}$  and current  $I_n$  for each phase [2]. The measurement of the voltage  $U_{Nn}$  must be performed by direct tapping to each phase  $L_n$ . The current is measured indirectly with the magnetic field around the conductor via current transformers. Thus, an electrical measurement is possible without interrupting the circuit. [13]

## 2.3 Analysis of Electrical Energy Data

To derive energy efficiency measures for machines and components, it is necessary to analyze measurement and meta data [3]. Analyzing electrical load profiles enables the allocation of the total energy demand to single components, workpieces, machining operations and energy states as well as estimating and forecasting the energy demand per time interval [3, 14]. Further applications include the detection of load fluctuations and the identification of deviations from a reference load profile [15]. Supervised and unsupervised machine learning algorithms can be applied for this purpose to avoid time-consuming analyses that require expertise [3, 14].

# 3 Framework

## 3.1 Methodology

Following the concept proposed in [6, 8] and [3] for the assessment of energy efficiency potentials of machine tools, the framework shown in Fig. 1 is presented for all production machines powered by electrical energy. The framework can be divided into the three main building blocks preparation, Raspberry Pi App (RPi App) and Web App. The preparation begins with the selection of electrical consumers for the measurement. Relevant energy consumers can be identified using an energy portfolio or a Pareto analysis [16]. Suitable current transformers are then selected on the basis of circuit diagrams and the electrical installation is conducted. Following the preparation, the frontend of the RPi App allows the user to enter the measurement configuration, to verify measurement data graphically and to initiate and conclude the measurement. Simultaneously, values are continuously read from the measuring devices and stored into a SQLite database by the backend.

The Web App features direct import of data from the RPi App, management of multiple devices and analysis of measurement data involving machine learning algorithms with no additional expertise required for data preparation. In addition, data for long-term storage can also be exported via the Web App.

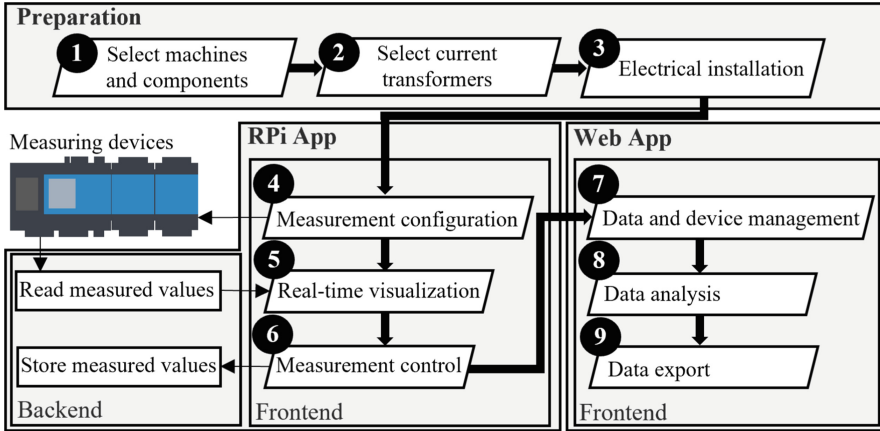
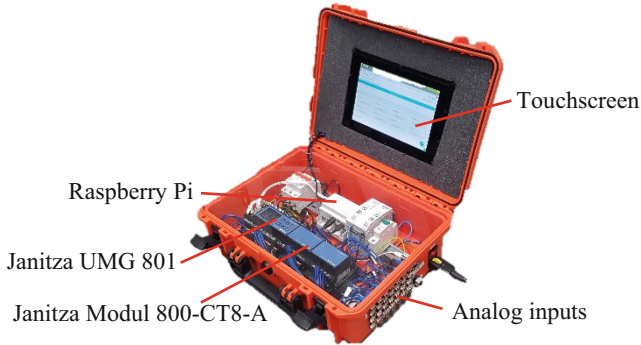


Fig. 1. Framework for identifying energy efficiency potentials of production machines.

### 3.2 Energy Transparency and Analysis System

The developed energy transparency and analysis system (ETAS) which is shown in Fig. 2 includes the hardware and the RPi App as the software. The hardware contains a power analyzer with current measuring modules forming the measuring device. Further components of the hardware are current, voltage and temperature sensors, a RPi and a touchscreen. The software can be divided into the RPi App installed on the ETAS and the Web App deployed on the user's computer or a server. The RPi App handles the measurement configuration and execution leading to the data acquisition and the Web App is used for data analysis and management including data export.

**Hardware Implementation.** The hardware part of the ETAS consists of voltage probes, 24 current sensors and four multi-functional sensors (e.g. residual current or temperature sensors), which can be connected as analog inputs. The connectors enable the use of sensors of different accuracies and measurement ranges, depending on the nominal power and intended use. The sensors are attached to the power analyzer, which is a Janitza UMG 801, equipped with two Janitza 800-CT8-A modules. The power analyzer is connected to the RPi via an ethernet cable. The RPi's storage is extended by a 120 Gigabyte SD-card, which provides sufficient capacity for up to four years of measurements when recording all measurement channels at a sampling rate of 1 Hz. A touchscreen connected to the RPi offers an interface for the measurement configuration and the visualization of the measured values. Additionally, all electronic components are galvanically isolated from the voltage supply and the analog inputs.



**Fig. 2.** Energy transparency and analysis system (ETAS).

**Software Implementation.** The measurement configuration is entered via a Python application, which is visualized on the touchscreen. The user can configure the sensors, bundle multiple measurement channels into a single consumer and define a sampling rate of up to 5 Hz. The final configuration is transferred to the power analyzer via Open Platform Communications Unified Architecture. The most recent measured values are visualized subsequently to verify their validity. If no currents  $I_n$  are permanently negative, values of  $\varphi_n$  are between 0 and 1, and the voltages  $U_{Nn}$  equal  $(230 \pm 10)V$ , the electrical installation is considered valid for the measurement. Afterwards, the measurement can be started and the RPi App reads the measured values from the power analyzer, stores them in a comma-separated text file and visualizes the trends of the active power for each component.

### 3.3 Web App

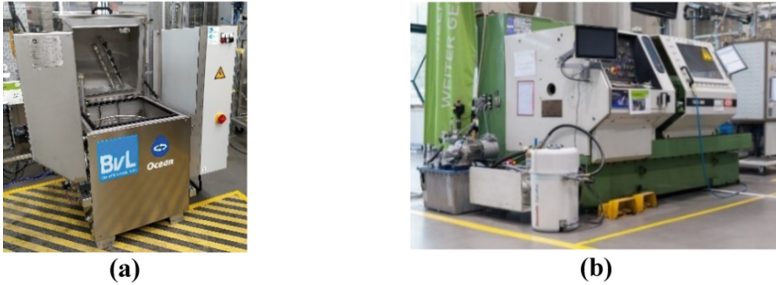
Due to the limited computational power of the RPi, an external Web App is used for further tasks. The Web App provides the functionality to manage multiple ETAS and import data from them via Secure File Transfer Protocol. In addition, analysis procedures such as machine learning algorithms with the subsequent calculation of energy key performance indicators can be deployed within the Web App. Moreover, the Web App aggregates all data from the managed ETAS within a SQLite database and allows the export of measurement data for long-term data storage.

## 4 Use Cases

### 4.1 Experimental Setup

The ETAS and the presented framework are applied to a cleaning machine (Fig. 3 (a)) and a lathe (Fig. 3 (b)) within the ETA Research Factory at the Technical University of Darmstadt. These machines are well suited for the use cases since they combine multiple electrical components and demonstrate the applicability of the framework to different production tasks. Within the same production chain, shafts are turned on the

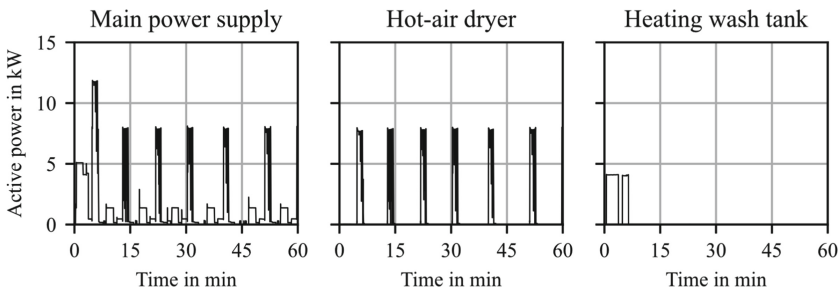
lathe and gears are processed in the cleaning machine to be later assembled into a gearbox. The ETAS is installed to all components on each machine. In the presented use cases, measurements were conducted on each machine for one hour, which was considered a representative period, since the cycle time is approximately 6 min for the cleaning machine and two minutes for the lathe.



**Fig. 3.** (a) Cleaning machine and (b) lathe at the ETA Research Factory.

## 4.2 Results

The measurement results are partially shown in Fig. 4 for the cleaning machine. Algorithms such as those presented in [3] provide a possibility for automatic data analysis of load profiles for the detection of machine states. This enables energy performance indicators to be calculated. For the measurement data of the two presented production machines, the machine states were automatically identified using the machine learning algorithm Gaussian Naive Bayes [17] within the Web App. Subsequently, the non-production time factor (NPTF) is calculated, which is defined as the ratio of non-production time and total observed time [18]. Both the algorithm and the NPTF are suitable to demonstrate the application of the framework exemplarily. For the performed studies, the non-production time corresponds to the equipping time of the machines.



**Fig. 4.** Load profiles of the main power supply, hot-air dryer and heating wash tank of the cleaning machine.

Figure 5 illustrates the calculated NPTF of the two machines alongside the relative energy consumption of all measured components together with their nominal power. This

shows that the equipment time for the cleaning machine is comparatively high and that the main drives, heating wash tank and chiller require a considerable amount of electric energy. Moreover, the heating wash tank and hot-air dryer reveal how components with lower nominal power can consume more energy. The load profiles of the individual components indicate that the higher degree of utilization of the heating wash tank is responsible for this. Possible energy efficiency measures for these studies could include shortening the equipping time and improving the thermal insulation of the cleaning machine, as well as using more efficient main drives and chiller on the lathe. However, the measures need to be examined more closely for final conclusions to be drawn.

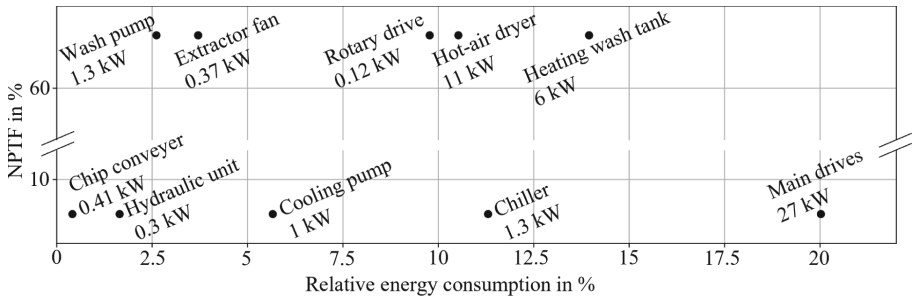


Fig. 5. NPTF and relative energy consumption of the measured components.

## 5 Summary and Outlook

To provide a straightforward holistic framework for all steps from initial measurement configuration to final data analysis, the ETAS was developed. The framework was applied on two production machines, showing its ability to quickly determine the components of the machines which might be suitable candidates for efficiency improvements. Nevertheless, the approach presented does not provide a quantifiable information about energy saving potentials or actual energy saving measures.

However, analyses as shown in Fig. 5 can provide deeper energy transparency on machine and component level and therefore be a starting point for identifying organizational and technical energy efficiency measures. Further developments of the software will include an extension of the available analysis algorithms, the integration of additional energy performance indicators and the implementation of an expert systems for energy efficiency measures.

**Acknowledgements.** The presented framework was developed within the project “KI4ETA” (grant agreement No. 03EN2053A). The ETAS was implemented within the project “Mittelstand-Digital Zentrum Darmstadt” (grant agreement No. 01MF21006A). The authors gratefully acknowledge financial support of both projects by the Federal Ministry of Economic Affairs and Climate Action (BMWK) and project supervision by the Projektträger Jülich (PtJ) and Projektträger DLR.



## References

1. European Union: Complete energy balances (2022). <https://appsso.eurostat.ec.europa.eu/nui/submitViewTableAction.do>. Accessed 25 Mar 2022
2. Kara, S., Bogdanski, G., Li, W.: Electricity metering and monitoring in manufacturing systems. In: Hesselbach, J., Herrmann, C. (eds.) *Glocalized Solutions for Sustainability in Manufacturing*, pp. 1–10. Springer, Heidelberg (2011). [https://doi.org/10.1007/978-3-642-19692-8\\_1](https://doi.org/10.1007/978-3-642-19692-8_1)
3. Petruschke, L., Elserafi, G., Ioshchikhes, B., Weigold, M.: Machine learning based identification of energy efficiency measures for machine tools using load profiles and machine specific meta data. *MM SJ* (2021)
4. Mićković, A.: Energy metering and management practices of manufacturing companies: a systematic literature review. In: *IAEE* (2017)
5. Fresner, J., Morea, F., Krenn, C., Aranda Uson, J., Tomasi, F.: Energy efficiency in small and medium enterprises: Lessons learned from 280 energy audits across Europe. *J. Clean. Prod.* (2017)
6. Petruschke, L., et al.: Method to identify energy efficiency potentials of metal cutting machine tools in industry. *Procedia CIRP* (2020)
7. Denkena, B., et al.: Energy efficient machine tools. *CIRP Annals* (2020)
8. Beck, M., Helfert, M., Burkhardt, M., Abele, E.: Rapid assessment: method to configure energy performant machine tools in linked energy systems. *Procedia CIRP* (2016)
9. Devoldere, T., Dewulf, W., Deprez, W., Willems, B., Duflou, J.R.: Improvement potential for energy consumption in discrete part production machines. In: Takata, S., Umeda, Y. (eds.) *Advances in Life Cycle Engineering for Sustainable Manufacturing Businesses*, pp. 311–316. Springer, London (2007). [https://doi.org/10.1007/978-1-84628-935-4\\_54](https://doi.org/10.1007/978-1-84628-935-4_54)
10. Zein, A.: *Transition Towards Energy Efficient Machine Tools*. Springer, Heidelberg (2012). <https://doi.org/10.1007/978-3-642-32247-1>
11. Weck, M.: *Werkzeugmaschinen 4*. Springer, Heidelberg (2006)
12. Mühl, T.: *Elektrische Messtechnik*. Springer Fachmedien Wiesbaden, Wiesbaden (2017)
13. Gontarz, A.M.: *Energy assessment of machine tools within manufacturing environments*. ETH Zurich (2015)
14. Walser, T., Sauer, A.: Typical load profile-supported convolutional neural network for short-term load forecasting in the industrial sector. *Energy AI* (2021)
15. Teiwes, H., Blume, S., Herrmann, C., Rössinger, M., Thiede, S.: Energy load profile analysis on machine level. *Procedia CIRP* (2018)
16. Thiede, S.: *Energy Efficiency in Manufacturing Systems*. Springer, Heidelberg (2012). <https://doi.org/10.1007/978-3-642-25914-2>
17. Sammut, C., Webb, G.I.: *Encyclopedia of Machine Learning*. Springer, Boston (2010). <https://doi.org/10.1007/978-0-387-30164-8>
18. Dehning, P., Blume, S., Dér, A., Flick, D., Herrmann, C., Thiede, S.: Load profile analysis for reducing energy demands of production systems in non-production times. *Appl. Energy* (2019)

**Open Access** This chapter is licensed under the terms of the Creative Commons Attribution 4.0 International License (<http://creativecommons.org/licenses/by/4.0/>), which permits use, sharing, adaptation, distribution and reproduction in any medium or format, as long as you give appropriate credit to the original author(s) and the source, provide a link to the Creative Commons license and indicate if changes were made.

The images or other third party material in this chapter are included in the chapter's Creative Commons license, unless indicated otherwise in a credit line to the material. If material is not included in the chapter's Creative Commons license and your intended use is not permitted by statutory regulation or exceeds the permitted use, you will need to obtain permission directly from the copyright holder.





# Simulation-Based Efficiency Comparison of Different Mains Configurations for DC Grid Branches for Supplying Production Plants Based on a Rule-Compliant Design

Benjamin Gutwald<sup>(✉)</sup> , Freddy Ngankam Ndjemi , Martin Barth ,  
and Jörg Franke 

Institute for Factory Automation and Production Systems, Friedrich-Alexander-Universität  
Erlangen-Nürnberg, Egerlandstr. 7-9, 91058 Erlangen, Germany  
[benjamin.gutwald@faps.fau.de](mailto:benjamin.gutwald@faps.fau.de)

**Abstract.** Numerous research projects are investigating direct current (DC) grids for supplying energy to production plants. The motivation is the higher efficiency and lower material requirements compared to conventional grid structures, as fewer electrical conversion processes occur, regenerative energies can be coupled in more efficiently and recuperation energy can be stored better. The grid form and the associated earthing concept require different protective devices. The publication simulates two possible grid forms and compares the efficiency with an approximated power curve of a production cell. The publication gives researchers and plant planners an impression of how such a network is designed and which components influence the efficiency. It serves as a decision-making aid for the selection of the grid form and helps with the design of the electrical components.

**Keywords:** power grid · DC-Microgrid · simulation · energy efficiency · grounding method

## 1 Introduction

### 1.1 Motivation of DC Grids Branches for Production Plants

Triggered by the electricity war between Thomas Alva Edison (1847–1931) and George Westinghouse (1846–1914), there was constant competition between direct and alternating current (AC) for energy transmission. The development of the transformer (1881) made it possible to transport energy more efficiently over long distances, which led, among other things, to the worldwide implementation of alternating current networks. Since then, the connections of electrical equipment have been based on the AC voltages customary in each country.

In the meantime, DC-powered technologies, like many renewable energies and storage systems, are appearing as energy providers in the decentralized grids. Although numerous operating devices use direct current internally. The lossy conversion and

feeding of energy generated from renewable sources and storage in batteries into the alternating current grid takes place [1]. Very often, internal DC circuits are the basis of electronic components. A prime example of drive technology are powerful frequency converters. The modules operate with rectification in an intermediate circuit and subsequent inversion into a new voltage with variable frequency. With a DC network, the structure is reduced to an inverter, whereby the entire lossy rectification and the associated material costs are eliminated. This extended DC intermediate circuit with storage and consumers opens up the possibility of energy utilization of electrical braking energy, which is often only dissipated specifically in the form of heat via braking resistors [2–5]. In the industrial context, the introduction of DC grids can save around 10 to 12% of the total electrical energy per year [6].

In addition to energy savings, the need for electrically conductive material is also reduced. One factor is the changed topology of the DC grid with only two to a maximum of three current-carrying conductors instead of the four conductors required in the three-phase grid. A savings of up to 40% in conductive substances are predicted [7]. The elimination of numerous rectifiers and converters in equipment results in further material savings. Components with lower production costs and an associated saving in grey energy are feasible [8–10]. Furthermore, the control is simplified compared to AC grids, since the provision of reactive power is no longer necessary [11, 12]. Due to the increasing share of renewable energies in the overall energy mix, as well as through material reduction, the CO<sub>2</sub> footprint is significantly reduced [4, 13, 14].

## 1.2 Status of International Research

DC intermediate circuits for the integration of electric drives already exist in the industrial context in rare cases as so-called multi-motor groups with a common DC intermediate [2]. In energy distribution, high-voltage direct-current transmission is used for long-distance transmission distances. In addition, there are further projects with other voltage levels in the supply networks [15]. Various research projects currently relate to the holistic conversion to decentralised DC grids for production plants, e.g. “DC-Smart” and “DC-INDUSTRIE” [3, 16], with the follow-up project “DC-Industrie2” or “DC-Schutzorgane” relating to protection concepts, components as well as the coupled earthing system [17, 18]. The SiC4DC project investigated the CO<sub>2</sub> saving potential of wide-bandgap semiconductor converters of a DC grid [19]. DCIhyPASim specifically investigates hybrid grid concepts with bidirectional energy flow between AC and DC grid [20]. Various studies exist on fault cases in the different grid types and the first prototypical reference systems from industry show the basic concept for specific applications for the grid form [21–24]. In terms of research, the publications address in detail the niche of simulating the efficiency for different operating points as a load in two grid forms with components available on the market. The design complies with the regulations, thus provide plant planners with a decision-making aid for the grid configuration and design from the perspective of energy efficiency.

## 2 Simulation Model

The simulation model is based on two rule-compliant designs for the opening of a DC voltage feeder with the nominal voltage of 650 V (unipolar). For this purpose, the loss characteristics of the necessary switching and protection organs as well as the bidirectional rectifier are modelled using a simplified mathematical approach. The analysis is designed for a nominal power consumption of 36 kW in duty type S1 (continuous operation) [25]. The efficiency is calculated continuously for all operating points up to 1.25 times overload (45 kW). The model and the simulations only refer to the steady state and are most accurate near the nominal point. The components for the two grid designs are based on components, which are largely available on the market.

### 2.1 Description of the Types of Grid Design

Basically, DC network branches can be opened via two different earthing concepts, earthed topologies (DC-TN) and isolated systems (DC-IT). In the earthed network branch, the negative pole of the DC network (DCN) is usually connected to the earth potential. In the event of an earth fault between the positive and DC pole (DCP), a low-impedance connection is created, which can lead to dangerous currents for people and secondary damage to objects and increases the risk of fire.

In conventional AC networks TT, TN-S, in parts of TN-C-S or the IT network, residual current devices (RCD) detect faulty residual currents between the active conductors of an AC network and other potentials such as the earth potential and disconnect the circuit within a few milliseconds without delay. This protective device does not exist in the DC-Link, as even all-current sensitive RCDs (RCD type A) are not suitable for DC voltages due to their function [5]. As an alternative protective measure for the DC-side, isolated networks (DC IT networks) are becoming more important in research. In the IT network, there is a galvanic separation, e.g. a transformer or power electronics with internal galvanic separation, which separates the fault current of the secondary side from the earth potential of the supply network, so that no dangerous body currents can occur in the event of an earth fault. The protection concept in the IT network provides for insulation monitors that ground the network to high impedance for measurement purposes and, if necessary, only issue an alarm in the first case of a fault and disconnect the network branch from the network in the second case of a fault. [21].

Figure 1 shows such a system structure according to symbols of [26]. Further necessary design differences between the DC-TN network and the DC-IT network are the number of DC fuses (dependent on conductor size and fault management), the AC fuses required in this case in the secondary part of the isolating transformer, the AC mains filter with earth coupling and the number of solid state circuit breakers (SSCB), which enable the DC network to open circuits in the shortest possible time ( $\sim 10\text{--}20\ \mu\text{s}$ ) and thus counteract the development of fault currents and arcs. [6, 27].

In both systems, there is a circuit breaker on the AC side for safe isolation and for selective tripping in case of overcurrent, an optional and in some cases not compatible residual current circuit breaker (RCCB) type B, an active front end (combination of active line and active interface module, driven by an external control unit), an optional disconnecter for safe isolation of the DC according to IEC 60204-1 [28], as well as a

precharging circuit for limiting the inrush current of the capacitors in the DC circuit. The resistor of the precharging unit is only connected shortly of the mains starts and is consequently not considered for the simulation of the steady state.

In addition to the components of the load circuit shown, there is a 24 VDC control circuit that supplies the excitation current of the contactors (19 W each), the measurement technology (10 W in TN system, 22 W in IT system) and the control unit (24 W) of the power electronics.

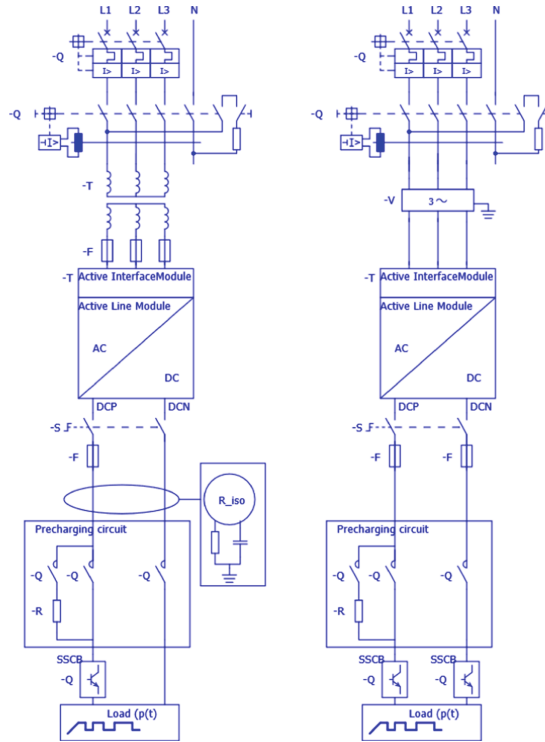


Fig. 1. Grid-circuit-diagram (left: DC-IT, right: DC-TN)

## 2.2 Modelling the Loss Characteristics

The modelling of the power loss is based on a simplified mathematical approach using the quadratic dependence between power loss and load. The approach can be derived from the electrical equivalent circuit of a source, a load and a series-connected loss resistor. A similar approach with this quadratic dependence can be found in issue 16 of the Siemens Technical Series Transformers [29]. Therefore, the relationship in Eq. (1) can be used for the approximation of the loss characteristics. Where  $P_V$  and  $P$  are respectively the power dissipated and the power consumed.

$$P_V = aP^2 + bP + c \quad (1)$$

For better comparability, the input power is related to the nominal power  $P_n$ . This only causes a scaling of the coefficients and results in Eq. (2). At the most components,  $b$  and  $c$  do not have a significant influence on the loss modelling.

$$P_v = a \left( \frac{P}{P_n} \right)^2 + b \frac{P}{P_n} + c \quad (2)$$

The coefficients  $a$  and  $b$  characterize the load-dependent and  $c$  the non-load-dependent losses and must be derived for the respective components. They can be calculated considering different operating points of the respective component.

$$P_v = \frac{P_{v,ll}}{k^2} \left( \frac{P}{P_n} \right)^2 + P_{v,ll} \quad (3)$$

In [29] a similar approach is used (Eq. 3) to determine the power loss of the transformer.  $P_{v,ll}$  corresponds to the coefficient  $c$  and is referred to as no-load power and  $k$  as the power factor. The factors mentioned can be taken from the datasheet of the transformer [30, 31]. The loss characteristics of the Active Line and Interface Module can be found in [31]. The presented approach is implemented within MATLAB Simulink. Figure 2 shows the corresponding loss model of a network component. The model receives the total power  $P$  as input and calculates the power loss  $P_v$  and the corresponding output power  $P_{out}$ .

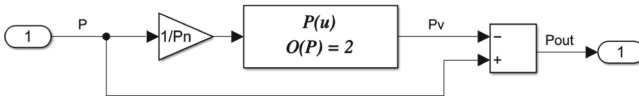


Fig. 2. Simulink model of a general component

### 2.3 Modelling the Grid System

The complete grid models are created by modelling, parametrizing and concatenating the individual components. The overall system receives as input the incoming power and returns the corresponding output power available to the load and the corresponding efficiency. The efficiency is calculated by setting the output power of in relation to the incoming power. The non-load dependent power of the control circuits is taken into account.

## 3 Results

This chapter creates transparency about the losses of the different design variants and thus provides plant planners with a decision-making aid. Figure 3 shows the losses of the individual components with the corresponding reference power. Switching and protective devices mainly consist of a resistive component, so that the losses increase

quadratically with the current. The losses of the active front end mainly result from the load-independent switching losses and the load-dependent ohmic conduction losses of the power semiconductors (here IGBT with 8 kHz pulse frequency) as well as the internal device cooling. Significantly high are the losses of the transformer and the associated secondary circuit fuses, which only occur in IT network form, as well as the SSCB losses, which even occur twice in DC-TN architecture.

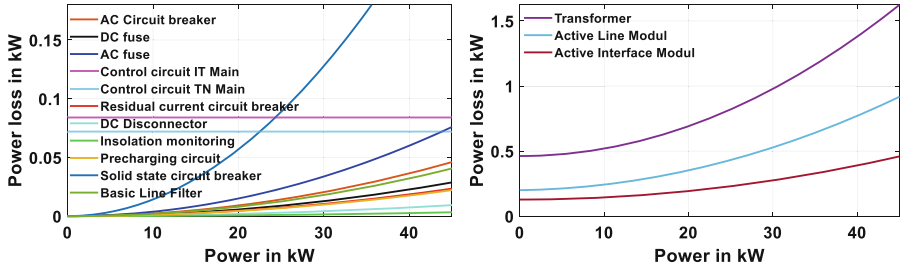


Fig. 3. Components power losses (left: control, switching and protection, right: conversion)

### 3.1 Comparison of the Net Forms

As a result of the losses of the individual components, the total efficiency of the network forms is shown in Fig. 4 for the entire power range of the network. As expected, the grids are relatively efficient around the nominal point and inefficient at low load. Basically, there are fewer losses over the entire power range in TN architecture.

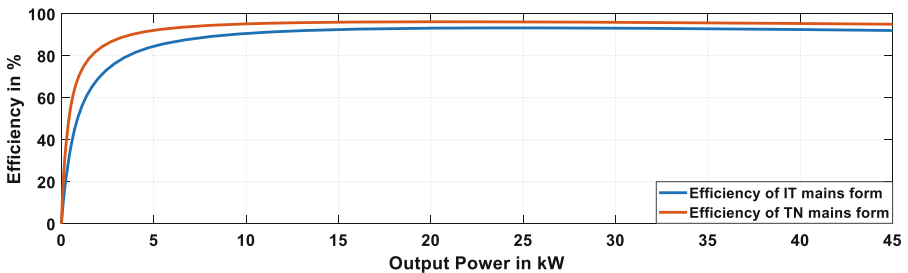
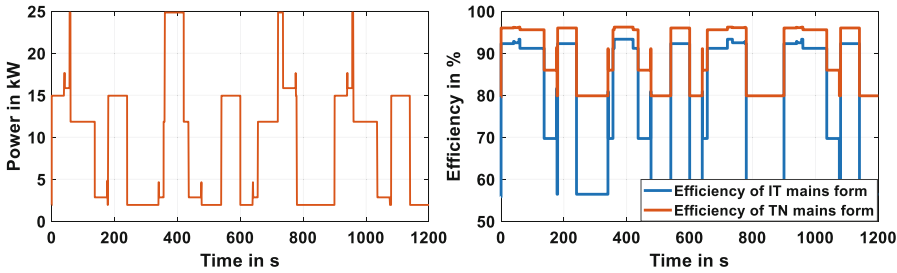


Fig. 4. Comparison of efficiency of DC-IT and DC-TN form

As an application example Fig. 5 shows approximated measurements of a real power curve of a production cell supplied with AC. The simplified assumption is made that this power demand would be requested directly as a load on the 650 VDC mains feeders. Equivalent to the findings from Fig. 4, the low efficiency in partial load operation and of the IT network feeder is noticeable (efficiency DC-TN 95,5%, DC-IT 89,7%).





**Fig. 5.** Comparison of efficiency of DC-IT and DC-TN form applied on an approximated power flow of an existing production plant

## 4 Conclusion

The paper introduced a simulation-based approach for planners on how to design DC energy networks for production plants. Firstly, the advantages of industrial energy grids are mentioned, including cost, material and energy savings. Furthermore, PV and energy storage can be integrated more easily. A simplified mathematical approach was used to determine the losses of the individual components depending on the incoming power. This allows conclusions to be drawn about the efficiency of the individual components and that of the system as a whole.

Along with efficiency, other decision criteria go into the selection of the network form. For example, the DC IT network is generally considered to be safer than the DC TN network, although the costs are often higher. Other selection criteria are electromagnetic compatibility and the possibility of integrating filters, availability/failure safety, and installation and maintenance aspects.

## References

1. Dragicevic, T., Lu, X., Vasquez, J.C., et al.: DC Microgrids—Part II. *IEEE Trans. Power Electron.*, 3528–3549 (2016)
2. Zentralverband Elektrotechnik und Elektronikindustrie e. V.: *Energieeffizienz mit elektrischen Antrieben* (2017)
3. Zentralverband Elektrotechnik und Elektronikindustrie e. V.: *Gleichspannungsnetze in der industriellen Produktion* (2017)
4. Gritzner, D., Knochelmann, E., Greenyer, J., et al.: Specifying and synthesizing energy-efficient production system controllers that exploit braking energy recuperation. *IEEE CASE* (2018)
5. VDE DKE: *Gleichstrom im Niederspannungsbereich: Deutsche Normungs-Roadmap Version 2* (2018)
6. Sauer, A. (ed.): *Die Gleichstromfabrik: Energieeffizient. Robust. Zukunftsweisend.* Hanser, München (2020)
7. Blank, F., Körner, W., Puls, S.: *Die Energieverteilung und Antriebstechnik im Gleichstromnetz: Projekt ‘DC-Industrie’ - Teil 2.* <https://www.computer-automation.de/feldebene/antriebe/artikel/164614/4/>. Accessed 11 May 2022
8. Savage, P., Nordhaus, R.R., Jamieson, S.P.: *DC Microgrids: Benefits and Barriers* (2010)

9. AlLee, G., Tschudi, W.: Edison redux: 380 Vdc brings reliability and efficiency to sustainable data centers. *IEEE Power Energy Mag.* **10**, 50–59 (2012)
10. Maerz, M., Wunder, B., Ott, L.: LVDC-Netze – Herausforderungen und Perspektiven. In: *ETG Conference* (2017)
11. Sanjeev, P., Padhy, N.P., Agarwal, P.: Peak energy management using renewable integrated DC microgrid. *IEEE Trans. Smart Grid* **9**, 4906–4917 (2018)
12. Olivares, D.E., Mehrizi-Sani, A., Etemadi, A.H., et al.: Trends in microgrid control. *IEEE Trans. Smart Grid* **5**, 1905–1919 (2014)
13. Weckmann, S., Sauer, A.: DC micro grid for energy efficient and flexible production. *Procedia Manuf.* **39**, 655–664 (2019)
14. Schaab, D.A., Weckmann, S., Kuhlmann, T., et al.: Simulative analysis of a flexible, robust and sustainable energy supply through industrial smart-DC-grid with distributed grid management. *Procedia CIRP* **69**, 366–370 (2018)
15. Juschkat, K.: Forschungsnetz testet Gleichstrom (2020). <https://www.elektrotechnik.vogel.de/forschungsnetz-testet-gleichstrom-im-einsatz-a-911460/>. Accessed 14 May 2022
16. ZVEI: dc-industrie.zvei.org (2022). <https://dc-industrie.zvei.org/>. Accessed 11 May 2022
17. ZVEI: DC-INDUSTRIE2 Vorstellung (2022). <https://dc-industrie.zvei.org/publikationen/dc-industrie2-projektvorstellung>. Accessed 11 May 2022
18. PTJ: Verbundvorhaben: DC-Schutzorgane (2022). <https://www.enargus.de/pub/bscw.cgi/?op=enargus.eps2&q=DC-Schutzorgane&v=10&s=3&id=602869>. Accessed 11 May 2022
19. Fuchs, J.: SiC4DC (2022). <https://www.faps.fau.eu/curforsch/sic4dc-edge-cloud-energy-management-for-dc-powered-automation-systems-with-sic-based-power-electronics/>. Accessed 11 May 2022
20. Retschkowski, M.: Digitale Planung und simulation hybrider AC/DC-Energienetze in automatisierten Produktionsanlagen. *M&A News* **03**, 3–5 (2021)
21. Kaiser, J., Gosses, K., Ott, L., et al.: Grid behavior under fault situations in  $\pm 380$  V DC distribution systems. In: *2017 IEEE Second International Conference*, pp 139–144 (2017)
22. Klosinski, C., Ross, P., Hemdan, N., et al.: Modular protection system for fault detection and selective fault clearing in DC microgrids. *J. Eng.* **2018**, 1321–1325 (2018)
23. ABB: Technical Application Papers No. 14-Faults in LVDC Microgrids (2015)
24. Hirose, K., Tanaka, T., Babasaki, T., et al.: Grounding concept considerations and recommendations for 400VDC distribution system. In: *2011 IEEE 33rd International Telecommunications*, pp. 1–8, 09 October 2011
25. International Electrotechnical Commission: Rotating electrical machines: Part 1: Rating and performance (60034-1:2022) (2022)
26. International Electrotechnical Commission: Graphical Symbols for Diagrams part 2-13 (60617-2...13) (1999)
27. Würfel, A.: PCIM Europe 2016: International Exhibition and Conference for Power Electronics, Intelligent Motion, Renewable Energy and Energy Management, Nuremberg, 10-12 May 2016: Proceedings. VDE, Berlin (2016)
28. International Electrotechnical Commission: Safety of machinery - Electrical equipment of machines: Part 1: General requirements (60204-1:2016) (2016)
29. Siemens, A.G.: Technische Schriftenreihe- Ausgabe 16: Transformatorauswahl in Abhängigkeit von Belastungsprofilen (2016)
30. Siemens, A.G.: Projektierungshandbuch SIMODRIVE 611 digital (2013)
31. Siemens, A.G.: Simamics S120 Leistungsteile (2019)

**Open Access** This chapter is licensed under the terms of the Creative Commons Attribution 4.0 International License (<http://creativecommons.org/licenses/by/4.0/>), which permits use, sharing, adaptation, distribution and reproduction in any medium or format, as long as you give appropriate credit to the original author(s) and the source, provide a link to the Creative Commons license and indicate if changes were made.

The images or other third party material in this chapter are included in the chapter's Creative Commons license, unless indicated otherwise in a credit line to the material. If material is not included in the chapter's Creative Commons license and your intended use is not permitted by statutory regulation or exceeds the permitted use, you will need to obtain permission directly from the copyright holder.





# Increasing Energy Efficiency and Flexibility by Forecasting Production Energy Demand Based on Machine Learning

André Trezn<sup>1</sup>(✉), Christoph Hoffmann<sup>1</sup>, Christopher Lange<sup>2</sup>,  
and Richard Öchsner<sup>2</sup>

<sup>1</sup> Fraunhofer-Institut für Produktionstechnik und Automatisierung,  
Universitätsstr. 9, 95447 Bayreuth, Germany  
{andre.trenz,christoph.hoffmann}@ipa.fraunhofer.de

<sup>2</sup> Fraunhofer-Institut für Integrierte Systeme und Bauelementetechnologie,  
Schottkystraße 10, 91058 Erlangen, Germany  
{christopher.lange,richard.oechsner}@iisb.fraunhofer.de

**Abstract.** The ability of manufacturing companies to compete depends strongly on the efficient use of production resources and the flexibility to adapt to changing production conditions. Essential requirements for the energetic infrastructure (EGI) result from the production itself, e.g., security of supply, efficiency and peak shaving. Since production always takes priority and must not be disturbed, the flexibility potential in terms of energy efficiency lies primarily in the EGI. Based on this, strategies will be developed that support companies in increasing their efficiency and flexibility by optimizing the configuration and operation of the EGI, while production processes are reliably supplied and not adapted. This is reached with intelligent operation strategies for the heating and cooling network based on forecasts, the use of energy storage systems, and the coupling of energy sectors. This paper presents an approach for energy forecasts used for the optimization of operation strategies. Hence, an energy-forecast-tool was developed, which is used for the prediction of electrical and thermal loads depending on the expected production. Therefore, machine learning models are trained with past weather, energy, and production data. Using production planning data and weather forecasts, the model can predict energy demands as input for an EGI optimization.

**Keywords:** Energy efficiency · Forecasting · Machine learning

## 1 Introduction

The exhaustion of fossil energy sources, increased use of renewable energy, restrictions due to government regulations or international interstate crises and conflicts, lead to higher energy prices and a weakening of confidence and financial markets [4, 10, 16]. In addition, as renewable energy is expanding and a

generation-based consumption is increasing due to volatility of renewable energies, industry is increasingly forced to flexibly adapt to energy supply [17, 18]. This change ensures a shift of the manufacturing industry towards more efficient and sustainable systems, thus requiring the identification of energy saving opportunities and the development of new strategies to improve the energy efficiency of industrial energy systems [4].

Since manufacturing companies are often under enormous competitive pressure and are forced to constantly optimize their production with regard to costs, quality and time, interventions in the ongoing production process are associated with effort and involve risks with regard to these three mentioned central factors of project management [18]. For this reason, the guiding principle in many areas is not to affect production. This leaves the energy infrastructure for providing the energy requirements (in the form of electricity, heating, cooling) of production as the only adjusting factor for energy saving potentials. This flexibilization of the energetic infrastructure (EGI) is being investigated in more detail in the ProEnergie Bayern research project [13] in order to derive operating strategies for the EGI using AI-based energy forecasts. These forecasts use production planning data and weather forecasts to predict load curves for the electricity, heating and cooling sectors. They can be used to generate an operating strategy for the EGI components in order, for example, to charge or discharge storage facilities in an optimized manner, to run energy plants at the optimal operating point and to reduce load peaks [9, 12].

## 2 Related Work

In this paper, the focus is on the prediction of energetic load curves of the production. In recent years, a large number of different prediction methods have been investigated. For example, significant benefits can be achieved by using simulations to predict energy demand. Due to the effort required for simulations, it can be more feasible for an SME to use energy measurements and numerical approaches to identify potential energy savings or efficiency improvements [7]. Therefore, an alternative to simulations are AI methods and thus machine learning (ML). For example, Artificial Neural Networks (ANN) [11] are well suited for energy consumption modeling [1, 8, 19]. Usually, an ANN is trained during the model development phase using experimental or previous operational data [14]. Among others, the focus for ML predictions in recent years has often been on energy predictions for buildings [3, 6, 20] or whole district heating systems, where the usual load forecasts are based on decision trees or simple neural networks [2, 5].

For industrial energy demand, there is a wide range of techniques for modeling and forecasting. Reinhardt et al. understand energy consumption forecasting as a modeling problem and therefore derive their classification scheme from the input-processing-output cycle of model development. The distinguished categories are system (consisting of the dimensions factory, multiple machines, single machine, and machine part), input (consisting of the dimensions energy,

environment, process, and product), and processing (consisting of the dimensions artificial neural network, fuzzy logic, empirical expression, simulation, and theoretical expression) [14].

Schmidt et al. suggest a methodology for the reliable prediction of specific energy consumption of arbitrary manufacturing processes. This methodology is based on a few energy measurements and requires little effort and previous knowledge due to precise specifications about the machines. Firstly, a decision tree is provided to categorize production machines into groups according to their energy consumption. Then for each machine group, an individual procedure is presented for establishing a prediction model. For this purpose, the energy consumption is either estimated with an average value or broken down into repeatable energy consumption components. For the complex machines, the energy consumption in manufacturing can be estimated using nominal power, exergy, simulation and empirical modeling [15].

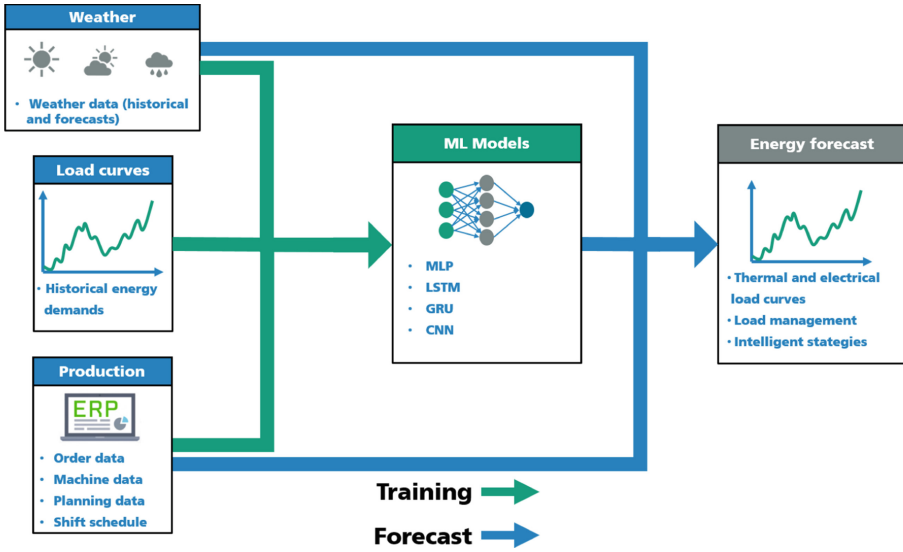
### 3 Concept

In the solution proposed the adaption and optimization of the configuration and operation of the EGI is reached through intelligent operation strategies, the use of electrical and thermal energy storage systems and the coupling of energy sectors. Therefore, energy forecasts are developed and used for the optimization of the strategies and the configuration of the EGI. To increase the accuracy of the forecasts, ML models are trained with past weather, energy and production data (historical data). As a result, these models can be used to forecast energy demands on factory, machine group or machine level on basis of production planning data and weather forecasts (planning data). Two software tools were developed for this approach: the energy-forecast-tool to predict the electrical and thermal loads depending on the expected production and the EGI-optimization-tool to optimize the EGI's components and operational strategy.

As shown in Fig. 1, historical data from three different sources is used for the model training in the energy-forecast-tool:

- i) production data: information about the processes (e.g. start and end time, duration), product and plant specific information (e.g. material, geometry, process id, number of produced parts), the shift schedule and the work center calendar.
- ii) energy demands: the electrical and thermal load profiles for the corresponding plant, section or factory.
- iii) weather data: temperature and humidity of the weather station of the factory or the nearest station of the German Metereological Service (“Deutscher Wetterdienst”, DWD).

Since the historical data was acquired from multiple different sources and was therefore not necessarily synchronized, the data needed to be harmonized in regard to a defined time interval. In this tool, a one-minute-interval was defined. For the training of the ML models, a time series was generated with a moving



**Fig. 1.** Schematic diagram of the presented concept

window. The size of the window depends on the use case and was set in the range between 60 min and 10 h. Each window corresponds with one data point of the energy demand data set. The data was then split into a train and test set, with a ratio of 75:25. The train set was used to train the models, and the test set to evaluate the models and to select the best trained model for further predictions. As shown in Table 1, multiple model architectures were trained and evaluated with varying hyperparameters in a defined range.

**Table 1.** Model architectures and hyperparameters

Architecture	Hyperparameters
Multi Layer Perceptron (MLP)	layers, units per layer
Long Short Term Memory (LSTM)	layers, units per layer, dropout
Gated Recurrent Unit (GRU)	layers, units per layer, dropout
Convolutional Neural Networks (CNN)	layers, units per layer, kernel size

The evaluation of the models is based on selected metrics, e.g. mean absolute error (MAE), root mean square error (RMSE) and coefficient of determination ( $R^2$ ). Afterwards, the best trained model can be used to predict energy loads based on production planning data and weather forecasts (planning data). Therefore, the data has to go through the same steps of preprocessing as described for the historical data. The predictions can be exported from this energy-forecast-tool for further use in the EGI-optimization-tool. The forecasting enables the

optimization of the operating strategies of the energetic infrastructure. For example, with the knowledge of upcoming electrical energy demands, the charging and discharging of electrical storage systems can be adjusted flexible to avoid load peaks and to purchase energy economically. In addition, power plants can be operated at their optimum efficiency level.

The EGI-optimization-tool was developed to simulate the industrial energy system based on models of the energy consumers, producers and storage systems. These models were mainly developed as grey-box models to reduce computing times and to increase the generalization and transferability for similar components. In the tool, the infrastructure was recreated with components that include different models and operating strategies that describe the functionality and purpose of the component within the EGI. The operating strategies include three types: reduction of peak loads, optimization of self-sufficiency for energy and increase in energy efficiency (e.g. optimal operating points). The energy demands are represented by historical load profiles or by the predicted energy loads from the energy-forecast-tool. The parameters of the energy producers and storage systems are being defined in entry forms of the tool. Afterwards, optimized operating strategies for the EGI components are simulated to increase the energy efficiency and flexibility of the EGI.

## 4 Experimental Evaluation

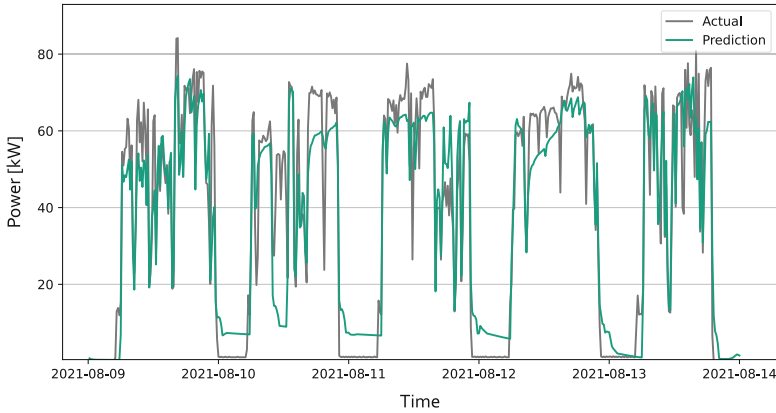
The concept of the energy-forecast-tool was evaluated on a use case at a manufacturing company in the metal processing industry. The research subject were two laser cutting machines. The aim was to predict the electrical load based on the production data. Therefore, the data was collected for six months and included the start and end date of the orders, the duration, the material number and thickness and the state of the machine, together with the shift schedule and the work site calendar. The electrical load was captured in 15 min intervals as an average for the elapsed period. Since these two datasets were not synchronous, the production data was transformed to a uniform time interval of one minute. Intervals where no order was produced were zero-filled. The 15 min intervals of the electrical load were then assigned to the corresponding 15 one minute intervals of the transformed production data.

The data was then split into a train, validation and test set (ratio of 65:10:25) without shuffling, so that the periods of the sets are consecutive in the mentioned order. The models were then trained on the train set and the hyperparameters were optimized on the validation set for each architecture. For the training of the models, the Adam algorithm was used as optimizer and the mean square error (MSE) was used as the loss function. Afterwards, the best trained models regarding the validation set were evaluated on the test data. As shown in Table 2, the best results over all metrics were achieved with the model with GRU layers.



**Table 2.** Results on test data for each architecture

Architecture	MAE	RMSE	R <sup>2</sup>
MLP	5.66 kW	9.96 kW	89.0 %
CNN	5.66 kW	10.10 kW	88.7 %
LSTM	5.69 kW	10.01 kW	88.9 %
GRU	5.29 kW	9.93 kW	89.0 %



**Fig. 2.** Predicted and actual load of one week in the test data with the GRU Model

Figure 2 shows the load predicted with the GRU model compared with the actual load over an one week period of the test data. A qualitative analysis of the prediction has indicated that the model was able to approximate the energy demand of the machine and to predict most of the load peaks. However, there were slight deviations observed, especially at the upper and lower limits.

## 5 Discussion and Future Work

The EGI-optimization-tool is used to investigate and optimize changes and extensions to the energy building infrastructure. The EGI can be configured dynamically. For example, the integration of generation plants and storage units can be examined. The optimization currently takes place via a so-called job list with multiple parameter sets. In the future, it will also be possible to integrate mathematical parameter optimization.

The energy-forecast-tool is used to predict the electrical and thermal loads depending on the expected production. The quality of the predictions strongly depends on the input, especially how accurate the planning data is. The production processes are not adapted or optimized, in that way, the tool does not disturb the production itself.

With our methodology, we were able to show that the energy demand can be predicted with ANNs on basis of production data. The best result was achieved with the GRU model, whereby the quality of the models depend on the amount of training data and thus could be further improved with data over a longer period.

AutoML approaches are intended to further reduce the user effort required to optimize the ML models. AutoML eliminates most of the manual steps of the classical iterative process (preparation of data, feature engineering, selection of the appropriate ML models and features, training of the models - incl. hyperparameter search, prediction by the model). Thus, the user only has to define the prepared training data as input and an optimized model is created automatically.

In addition, the approach of further developing the ML models with more and more data will be pursued in the future. Transfer learning will also be used to reduce the training effort and make it transferable for similar processes. Additionally, federated learning can be used here to optimize ML models across company boundaries.

**Acknowledgement.** This contribution was supported by the Bavarian Research Foundation as part of the research project “ProEnergie”.

## References

1. Ak, R., Helu, M.M., Rachuri, S.: Ensemble neural network model for predicting the energy consumption of a milling machine. In: 20th Design for Manufacturing and the Life Cycle Conference; 9th International Conference on Micro- and Nanosystems, vol. 4, p. V004T05A056. American Society of Mechanical Engineers, Boston (2015)
2. Beckmann, M., Hurtado, A., Technische Universität Dresden hrsg: Kraftwerkstechnik 2019: Power plant technology - Optimierte Wärmelastprognose mittels Deep Learning, p. 425. SAXONIA, Freiberg (2019)
3. Dagdougui, H., Bagheri, F., Le, H., Dessaint, L.: Neural network model for short-term and very-short-term load forecasting in district buildings. *Energy Build.* **203**, 109408 (2019). <https://doi.org/10.1016/j.enbuild.2019.109408>
4. Diaz C., J.L., Ocampo-Martinez, C.: Energy efficiency in discrete-manufacturing systems: insights, trends, and control strategies. *J. Manuf. Syst.* **52**, 131–145 (2019). <https://doi.org/10.1016/j.jmsy.2019.05.002>
5. Faber, T., Finkenrath, M.: Load forecasting in district heating systems using stacked ensembles of machine learning algorithms. In: *Gehalten auf der 14th International Renewable Energy Storage Conference 2020 (IRES 2020)*, Bonn, Germany (2021)
6. Fumo, N.: A review on the basics of building energy estimation. *Renew. Sustain. Energy Rev.* **31**, 53–60 (2014). <https://doi.org/10.1016/j.rser.2013.11.040>
7. Garwood, T.L., Hughes, B.R., Oates, M.R., O’Connor, D., Hughes, R.: A review of energy simulation tools for the manufacturing sector. *Renew. Sustain. Energy Rev.* **81**, 895–911 (2018). <https://doi.org/10.1016/j.rser.2017.08.063>
8. Kant, G., Sangwan, K.S.: Predictive modeling for power consumption in machining using artificial intelligence techniques. *Procedia CIRP* **26**, 403–407 (2015). <https://doi.org/10.1016/j.procir.2014.07.072>

9. Lange, C., Rueß, A., Nuß, A., Öchsner, R., März, M.: Dimensioning battery energy storage systems for peak shaving based on a real-time control algorithm. *Appl. Energy* **280**, 115993 (2020). <https://doi.org/10.1016/j.apenergy.2020.115993>
10. Liadze, I., Macchiarelli, C., Mortimer-Lee, P., Juanino, P.S.: The Economic Costs of the Russia- Ukraine Conflict, 12 (2022)
11. Lu, Z., Pu, H., Wang, F., Hu, Z., Wang, L.: The expressive power of neural networks: a view from the width. In: Guyon, I., et al. (hrsg.) *Advances in Neural Information Processing Systems*. Curran Associates, Inc. (2017)
12. Öchsner, R., Nuß, A., Lange, C., Rueß, A.: Research platform: decentralized energy system for sector coupling. *Chem. Eng. Technol.* **42**, 1886–1894 (2019). <https://doi.org/10.1002/ceat.201800714>
13. ProEnergie - Bayern. <https://www.proenergie-bayern.de/>
14. Reinhardt, H., Bergmann, J.-P., Münnich, M., Rein, D., Putz, M.: A survey on modeling and forecasting the energy consumption in discrete manufacturing. *Procedia CIRP* **90**, 443–448 (2020). <https://doi.org/10.1016/j.procir.2020.01.078>
15. Schmidt, C., Li, W., Thiede, S., Kara, S., Herrmann, C.: A methodology for customized prediction of energy consumption in manufacturing industries. *Int. J. Precis. Eng. Manuf. Green Technol.* **2**(2), 163–172 (2015). <https://doi.org/10.1007/s40684-015-0021-z>
16. Schuh, G., et al.: Datenbedarfe für eine energie-flexible Produktionsplanung und -steuerung. *Zeitschrift für wirtschaftlichen Fabrikbetrieb.* **113**, 550–553 (2018). <https://doi.org/10.3139/104.111966>
17. Walther, J., Weigold, M.: A systematic review on predicting and forecasting the electrical energy consumption in the manufacturing industry. *Energies* **14**, 968 (2021). <https://doi.org/10.3390/en14040968>
18. Weckmann, S., Jin, H., Sauer, A.: Demand side management - evaluation of DSM potential, based on the energy value stream. *wt.* **106**, 462–468 (2016). <https://doi.org/10.37544/1436-4980-2016-06-92>
19. Zhao, G., Hou, C., Qiao, J., Cheng, X.: Energy consumption characteristics evaluation method in turning. *Adv. Mech. Eng.* **8**, 168781401668073 (2016). <https://doi.org/10.1177/1687814016680737>
20. Zhao, H., Magoulès, F.: A review on the prediction of building energy consumption. *Renew. Sustain. Energy Rev.* **16**, 3586–3592 (2012). <https://doi.org/10.1016/j.rser.2012.02.049>

**Open Access** This chapter is licensed under the terms of the Creative Commons Attribution 4.0 International License (<http://creativecommons.org/licenses/by/4.0/>), which permits use, sharing, adaptation, distribution and reproduction in any medium or format, as long as you give appropriate credit to the original author(s) and the source, provide a link to the Creative Commons license and indicate if changes were made.

The images or other third party material in this chapter are included in the chapter's Creative Commons license, unless indicated otherwise in a credit line to the material. If material is not included in the chapter's Creative Commons license and your intended use is not permitted by statutory regulation or exceeds the permitted use, you will need to obtain permission directly from the copyright holder.





# The Use of Gentani Approach for Benchmarking Resource Efficiency in Manufacturing Industries

Shoaib Sarfraz<sup>(✉)</sup> , Mark Jolly , and Konstantinos Salonitis 

Sustainable Manufacturing Systems Centre, School of Aerospace, Transport and Manufacturing,  
Cranfield University, Cranfield, Bedfordshire MK43 0AL, UK  
shoaib.sarfraz@cranfield.ac.uk

**Abstract.** The majority of today's manufacturing processes are based on well-developed and well-established procedures that are characteristics of mature technologies. The manufacturing industries have not evolved significantly over time because of recent economic, environmental, and societal advances at an unprecedented rate. As a result, there are numerous challenges and opportunities available, especially regarding resource efficiency. The majority of industrial processes consume far more energy than the theoretical minimal process energy requirements. This paper aims to develop a theoretical framework utilising the Gentani approach whilst targeting the minimum resources needed to carry out a process for use by manufacturing industries. The resource efficiency (exergy) metric has also been discussed that can be used as a tool to evaluate the efficiency of industry, depicting a more holistic level of energy and material consumption. The framework will help manufacturing industries in lowering costs and remain competitive by improving resource efficiency, aimed at reducing resource use and providing value delivery. The study will also assist in transforming these industries into resource-efficient modern manufactories in line with the Net-Zero 2050 agenda.

**Keywords:** Manufacturing · Net Zero · Gentani · Resource Efficiency · Exergy

## 1 Introduction

Manufacturing is a major embodiment of a country's national economy and overall national strength, as well as a cornerstone industry for building human wealth. The manufacturing industry plays a critical role in the generation of value for its customers; however, this value generation involves processes that are material and energy-intensive. This produces a lot of waste and has a negative impact on the environment [1]. According to the International Energy Agency (IEA) statistics, the industrial sector accounted for about 26% of global CO<sub>2</sub> emissions and 38% of global energy use in 2020 [2]. Environmental pollution and resource scarcity push the energy and resource-intensive industries towards the future targets of the net-zero 2050 agenda which is to transform these industries into resource-efficient and non-polluting manufactories.

Most industrial processes consume much more energy than the theoretical minimal process energy requirements. For instance, steel production from iron requires the theoretical energy of 6.7 GJ/ton, plus an extra 1.2 GJ/t for melting [3], whereas globally an

average of 22.6 GJ energy is used for 1 ton of material [4]. Cement processing requires only 1.8 GJ/t, but the average industrial value is 4.6 GJ/t. For flat glass production 3 GJ/t energy is required, this is significantly less than the present energy consumption of 7 GJ/t, resulting in 43% energy efficiency [5]. This shows that there are opportunities available to explore the resource efficiency of processes involved in the manufacturing industries.

Conventionally material efficiency and energy intensity metrics are used to measure the resource efficiency of the industry. However, since these metrics require different units that cannot be integrated (e.g., kg with kJ), a thorough analysis of industry efficiency is not permissible. This limitation has been addressed by exergy which can be used as a metric to measure both material and energy utilisation in a single integrated metric [6]. The exergy of a production process involves its both physical and chemical exergy. Physical exergy is the maximum useful work a particular flow can do until it reaches thermomechanical equilibrium with the atmospheric conditions [7]. Whereas chemical exergy denotes the ability of a material to do work due to its chemical composition difference in relation to the (surrounding) environment [8]. Exergy analysis can be employed to measure the interaction and trade-off between material and energy flow. It is stated that exergy provides a meaningful value to resource efficiency since it specifies the quality of a commodity, allowing the practitioners to distinguish the desired product from waste or by-products [9]. The automobile industry has also begun to employ resource efficiency throughout its production chain by creating components that consume significantly less fuel [10]. Toyota has successfully reduced the energy usage of its vehicle production focusing on the real minimum resource required for any process, the adopted approach is known as Gentani [11].

The word “Gentani” is a Japanese phrase that originated from the term called “Kousuu”, which refers to an approach based on resource consumption that enables users to determine the minimum resources used in an activity. In the later version, it is referred to as Gentani. In Japan, Gentani is extensively used in the manufacturing sectors to highlight resource consumption and devise new approaches and work support services to improve the utilization of resources and meet the set targets [12, 13].

This work is a part of the TransFIRE project that aims to transform the foundation industries in line with the net-zero agenda. Applying Gentani is one of the important research objectives of this project i.e., to identify the minimum resource required to perform a particular process. This paper is focused on developing a theoretical framework based on the Gentani approach highlighting the bare minimum of resources required to complete a process for application in manufacturing industries.

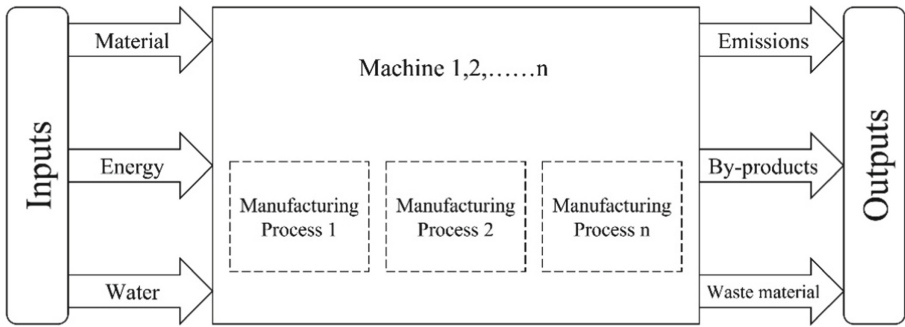
## **2 Theoretical Framework Based on Gentani Approach**

This study proposed a theoretical framework based on the Gentani approach, following the four steps provided below.

### **2.1 Develop Process Models**

The primary step of this framework involves the development of process models that account for materials, energy, water, and non-product flows like emissions, compressed

and blown air, by-products, process and cooling water and waste materials. Figure 1 provides a visual picture of an overall process model for a generic production system. This model can be further decomposed into detailed process models to provide a comprehensive overview of all the input resources and outputs associated with each manufacturing/sub-process.



**Fig. 1.** Graphical picture of a generic process model

## 2.2 Develop and Evaluate Targets

The second step is to develop and evaluate targets for the most efficient use of resources for each manufacturing process and use these to benchmark processes in the manufacturing industries. Additionally, determine how distant the manufacturing sector is from meeting these targets.

There are several processes involved in the manufacturing industries such as heat exchange, comminution, cooling, material handling and transportation, etc. All of these processes require a lot of energy and resources. Based on the theoretical calculations the absolute minimum resource required to accomplish these processes can be estimated and the optimal resource efficiency for these processes is benchmarked. Comparing the difference between present and benchmark values provide an idea of how far the manufacturing sector is from its ideal target values.

## 2.3 Determine Best Practices

Identification of best practices for obtaining the maximum resource utilisation in the manufacturing sector/industry is performed in the third step. One of the examples of best practices is to reincorporate by-products into the production process which can help improve the resource efficiency of a sector by up to 4% [9] (see Fig. 2). The other examples may include the capture of waste heat/energy and reutilising it. These practices can help manufacturing industries to get closer to the best feasible resource efficiencies.



Fig. 2. Introduction of by-products as an input material [5]

## 2.4 Integrate Knowledge

Lastly, approaches to attain the targets in Sect. 2.2 are identified and knowledge is transferred into the manufacturing sector to help overcome any encountered barriers.

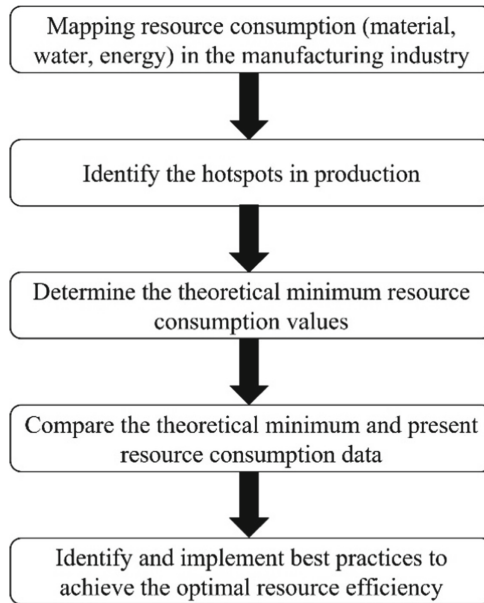
An overall outline of the proposed framework is shown in Fig. 3. Mapping of resource consumption is important to identify the inputs and outputs involved in the process. This will also help to determine the hotspots (highest resource consumption) in the production. The optimum resource efficiency of the process can be benchmarked by calculating the theoretical minimum resource consumption value and comparing it with the industrial resource consumption data. To achieve optimum resource efficiency, it is necessary to identify and implement the best practices.

## 3 Resource Efficiency Metric

Resource efficiency is an important feature of sustainable policies and practices, especially in industries that use a lot of energy. The industry employs resource efficiency as a strategy to produce more suitable outputs with the minimum possible inputs [14]. It is used by industry leaders and governments to set priorities based on a product's added value and to identify areas where a process can be improved. Resource efficiency is a well-established metric for determining the total energy performance of the manufacturing industry.

Currently, energy intensity and material yield are the typical forms of metrics that are used to evaluate plant efficiency in terms of resource usage. However, these metrics are focused on a particular resource. The calculation of resource efficiency necessitates the use of a single objective unit for all resources [15]. Exergy is one approach to do this that accounts for both material and energy usage. It presents the maximum useful work that a system can perform [16].

Hernandez et al., [17] proposed the resource efficiency metric as a tool (measured in exergy) to holistically measure industry efficiency considering both material and energy consumption. This metric allows the integration of four major possibilities for improving resource efficiency, that are usually considered separately: reducing fuel and material inputs along with recovering energy and material by-products. In another work,



**Fig. 3.** Outline of the conceptual framework

Hernandez and Cullen [6] found exergy as an effective metric for measuring the resource efficiency of the industry. This reveals the exergy metric as the best approach to evaluate the industry resource efficiency.

## 4 Conclusions

The manufacturing sector consumes a huge amount of energy compared to other end-use sectors and therefore has a huge potential for improvement in terms of lowering energy usage and emissions. In this paper, the use of the Gentani approach has been introduced to benchmark resource efficiency in the manufacturing sector. A theoretical framework has been presented that can help resource-intensive manufacturing industries to identify theoretical and actual resource consumption limits (water, energy and materials). This novel approach will uncover many opportunities for the manufacturing sector in terms of performance enhancement.

Resource efficiency can be measured with different metrics such as energy efficiency, energy intensity and material efficiency that are limited to a specific resource. The exergy-based metric is a comprehensive measure of resource efficiency that can be used to examine, analyse, and optimise industrial processes as a measure of both material and energy quality. Exergy analysis is a more realistic way to justify the system's performance than material and/or energy analysis.



## 5 Future Directions

Using the Gentani approach this study aims to develop a theoretical framework to benchmark and identify best practices in the manufacturing sector in terms of resource efficiency (energy, water, material etc.). However, the work is limited to a high-level framework. This is an ongoing project and will be explored further towards an advanced level of the framework by involving industrial experts. Moreover, some case studies will be performed to evaluate the framework with the industrial partners of TransFIRE.

Further research is in progress to identify and benchmark the resource efficiency of the common processes across the foundation industries. Detailed level process models will also be developed looking at the whole aspect of manufacturing.

**Acknowledgement.** The authors would like to acknowledge the Transforming Foundation Industries Research and Innovation hub (TransFIRE) for the support of this work. TransFIRE (EP/V054627/1) is funded by UKRI.

## References

1. Cai, W., Liu, F., Xie, J., Zhou, X.: An energy management approach for the mechanical manufacturing industry through developing a multi-objective energy benchmark. *Energy Convers. Manag.* **132**, 361–371 (2017). <https://doi.org/10.1016/j.enconman.2016.11.024>
2. International Energy Agency (IEA): Tracking industry 2021. <https://www.iea.org/reports/tracking-industry-2021>. Accessed 28 Apr 2021
3. Fruehan, R.J., Fortini, O., Paxton, H.W., Brindle, R.: Theoretical minimum energies to produce steel for selected conditions. U.S. Department of Energy Office of Industrial Technologies, Washington DC (2000)
4. Gonzalez Hernandez, A., Paoli, L., Cullen, J.M.: How resource-efficient is the global steel industry? *Resour. Conserv. Recycl.* **133**, 132–145 (2018). <https://doi.org/10.1016/j.resconrec.2018.02.008>
5. Jolly, M., Velenturf, A.P.M., Salonitis, K., Paddea, S.: The UK transforming the foundation industries research and innovation hub (TransFIRE). In: *Developing Tomorrow's Technical Cycles*, vol. I, pp. 341–353 (2022). [https://doi.org/10.1007/978-3-030-92563-5\\_35](https://doi.org/10.1007/978-3-030-92563-5_35)
6. Hernandez, A.G., Cullen, J.M.: Exergy: a universal metric for measuring resource efficiency to address industrial decarbonisation. *Sustain. Prod. Consum.* **20**, 151–164 (2019)
7. Gao, D., Peng, X., Song, Y., Zhou, P.: Splitting physical exergy by its feasible working ways. *Processes* **9**(11), 2091 (2021). <https://doi.org/10.3390/pr9112091>
8. Michalakakis, C., Fouillou, J., Lupton, R.C., Gonzalez Hernandez, A., Cullen, J.M.: Calculating the chemical exergy of materials. *J. Ind. Ecol.* **25**(2), 274–287 (2021). <https://doi.org/10.1111/jiec.13120>
9. Carmona, L.G., Whiting, K., Carrasco, A., Sousa, T.: The evolution of resource efficiency in the United Kingdom's steel sector: an exergy approach. *Energy Convers. Manag.* **196**, 891–905 (2019). <https://doi.org/10.1016/j.enconman.2019.06.060>
10. ACEA: ACEA position paper on circular economy. European Automotive Manufacturers Association (2015)
11. GreenBiz: How Toyota uses gentani to optimize performance and cut waste (2014). <https://www.greenbiz.com/article/how-toyota-uses-gentani-optimize-performance-and-cut-waste>. Accessed 05 May 2022

12. Yoshikawa, T., Innes, J., Mitchell, F.: Performance measurement for cost management: the nature and role of Kousuu. *J. Manag. Account. Jpn.* **5**(2), 47–61 (1997). [https://doi.org/10.24747/jma.5.2\\_47](https://doi.org/10.24747/jma.5.2_47)
13. Yoshikawa, T.: Cost accounting standard and cost accounting systems in Japan. Lessons from the past - recovering lost traditions. *Account. Bus. Financ. Hist.* **11**(3), 269–281 (2001). <https://doi.org/10.1080/09585200126618>
14. Ekins, P., et al.: Resource efficiency: potential and economic implications. United Nations Environment Programme (2016)
15. Allwood, J.M., Ashby, M.F., Gutowski, T.G., Worrell, E.: Material efficiency: a white paper. *Resour. Conserv. Recycl.* **55**(3), 362–381 (2011). <https://doi.org/10.1016/j.resconrec.2010.11.002>
16. Kellens, K., Dewulf, W., Dufloy, J.R.: Exergy efficiency definitions for manufacturing processes. In: Hesselbach, J., Herrmann, C. (eds.) *Glocalised Solutions for Sustainability in Manufacturing*, pp. 329–334. Springer, Heidelberg (2011). [https://doi.org/10.1007/978-3-642-19692-8\\_57](https://doi.org/10.1007/978-3-642-19692-8_57)
17. Hernandez, A.G., Paoli, L., Cullen, J.: Resource efficiency in steelmaking: energy and materials combined. *Energy Procedia* **142**, 2429–2434 (2017)

**Open Access** This chapter is licensed under the terms of the Creative Commons Attribution 4.0 International License (<http://creativecommons.org/licenses/by/4.0/>), which permits use, sharing, adaptation, distribution and reproduction in any medium or format, as long as you give appropriate credit to the original author(s) and the source, provide a link to the Creative Commons license and indicate if changes were made.

The images or other third party material in this chapter are included in the chapter's Creative Commons license, unless indicated otherwise in a credit line to the material. If material is not included in the chapter's Creative Commons license and your intended use is not permitted by statutory regulation or exceeds the permitted use, you will need to obtain permission directly from the copyright holder.





# Increase Efficiency of Energy Transmission by Incentives

Benjamin Jacobsen<sup>(✉)</sup>

Chair of Power Systems and High-Voltage Engineering, Chemnitz University of Technology,  
Reichenhainer Straße 70, 09126 Chemnitz, Germany  
benjamin.jacobsen@etit.tu-chemnitz.de

**Abstract.** The sustainability of manufacturing processes can be monitored by various key performance indicators and usually has a positive impact on the operating result. There are thus direct incentives to maximize efficiency and sustainability. The situation is different for the transmission of electrical energy. Energy transmission and distribution are generally regulated economic sectors in which incentive regulation methods are used to ensure economic efficiency. The current regulations provide only limited incentives for the energetic and ecological efficiency and sustainability of the transmission and distribution of electrical energy. With this paper a key figure is presented that enables a better consideration of ecological aspects in the incentive regulation. This creates a better incentive to increase transmission efficiency, which has a direct positive impact on all downstream manufacturing processes.

**Keywords:** electrical energy · energy transmission · incentives · regulations · sustainability

## 1 Background and Benefits of Incentives to Improve the Efficiency of Energy Transmission

### 1.1 Significance of Energy Transmission for Manufacturing Processes

The economic well-being of nations can be traced back, among other things, either to a wealth of raw materials or to technologically sophisticated value creation. The former source of wealth can only be used sustainably in a few cases due to territorial conditions, which is one reason why industrial value creation has a high status. For a century now, this value creation has increasingly been carried out with the help of processes that use electrical energy as their main source [1]. The importance of electrical energy for value creation and the associated prosperity in industrial nations is thus elementary. This is one of the reasons why the correlation between the demand for electrical energy and economic growth (Gross Domestic Product growth) cannot be empirically proven since 1979 [2]. Due to the high importance of electrical energy, it is treated as a scarce resource [3] which ultimately leads to an increase in efficiency in the use of electrical energy. Despite or precisely because of this high efficiency, the reliability of supply with

electrical energy has a particularly high weighting. Despite the high importance of the efficient and reliable supply of electrical energy, a gap exists in metrics for evaluating and incentivizing improvements in the efficiency of energy transmission.

## 1.2 Detecting and Avoiding Preventable Losses

In almost all manufacturing processes, quite a lot of effort is put into minimizing losses. For this purpose, there is a quite comprehensive set of methods. In addition to flow cost accounting [4], there are methods that provide for an analysis of the entire life cycle. These include, above all, the LCA (Life Cycle Assessment or Life Cycle Analysis) method standardized in accordance with DIN EN ISO 14040/14044. These methods are difficult to apply to electrical energy. This is mainly due to the fact that transmission losses are determined by a large number of technical and infrastructural parameters. Furthermore, the value chain or better the value network is divided into several, separate companies, so it is necessary to stimulate the avoidance of losses where they occur. One example of preventable losses is the transmission losses due to harmonics. Harmonics are a parameter of power quality. The concept of power quality encompasses a portfolio of grid voltage characteristics. At present, there is no way to define power quality as a single indicator [5]. From the various factors of power quality, according to DIN EN 50160, the harmonic content is singled out. Because the harmonic content in the power grid will be expected to increase, which is due to the increase in power electronics [6]. The increase in harmonics reduces the efficiency of electric power transmission by causing avoidable energy losses (caused by harmonic currents) in the grid and has a negative impact on the overall efficiency of the power system. These additional losses cause equipment to heat up, which can lead to increased aging and failures. Furthermore, losses during transmission and distribution are largely influenced by the grid load itself, i.e. by the energy transmitted with the help of the power supply grid. There is a quadratic relationship between power loss and transmitted current. This means that grid users have quite a strong leverage in influencing transmission losses. However, under current legislation, grid operators are responsible for grid losses and there is only a disproportionately small incentive to reduce grid losses [7], so there is no incentive to improve the distribution of costs so that grid users have an incentive to use energy in manufacturing processes in a way that benefits the grid.

## 1.3 Use of Incentive Regulation as a Leverage Mechanism

Due to its technical and economic specifications, electrical grids are a natural monopoly [8] - also referred to as an unavoidable monopoly [9]. Furthermore, the high investment costs in connection with regulated revenues - resulting from the efficiency comparison according to the German incentive regulation ordinance (German: Anreizregulierungsverordnung - short: ARegV) [10] - and thus a long-term capital commitment lead to a secured revenue structure for grid operators. This long capital commitment is also underlined by the long service life of electrical operating resources [11], most of which are irreversible due to the high installation costs [12] and shows the need for a high level of long-term revenue security, which can usually only be realized through a

regulated market [13]. In addition, the incentive regulation ordinance offers the possibility to contribute to the avoidance of possible inefficiencies through incentives. This makes it possible to use this tool directly, to expand it and to reduce preventable transmission losses. The advantage of this approach is that, on the one hand, a permanent success control is carried out. As in the current incentive regulation, the losses can be set in relation to those of the base year.

## **2 State of the Art**

### **2.1 Incentive Regulation Widely Used**

The present study refers to the Federal Republic of Germany. The statements and results can be applied to a large number of other countries, but it must be clarified in each case how transmission losses are considered in the respective system. Incentive regulation is the linchpin of the concept of regulating natural monopolies. Furthermore, one reason for regulation is the high importance of electrical energy as a fuel for a large number of manufacturing processes. In a paper on the regulation of the German power grid, DIEKMAN et al. compiled a list of foreign regulatory systems of the electric power transmission and distribution system. The result shows that incentive-regulated systems are widely used [14]. The advantage of incentive-based revenue regulation over cost-based revenue regulation is that it creates incentives to reduce inefficiencies. The disadvantage, however, is that the incentive must be high enough so that the benefits from reducing inefficiencies outweigh the lower revenues from maintaining them.

### **2.2 Necessity Recognized - Implementation in Need of Improvement**

The introduction of incentive regulation based on the amendment to the German Energy Act of 2005 [15] shows that the need to reduce inefficiencies has been recognized. One of the core elements of regulation is the efficiency comparison of grid operators, which creates comparability between grid operators in an elaborate procedure. Efficiency is ultimately calculated as the quotient of the performance provided by the grid operators and the effort required to achieve it. The output is determined by a number of comparative parameters, such as the length of the grid or the maximum output as well as the transmitted energy. The effort is reflected by the costs incurred for this. The current approach thus tends to lead to a comparison of performance. The term efficiency comparison is misleading in the sense that energetic aspects, which are today rather associated with the term efficiency, are not taken into account. An approach for improving this weakness will be presented in the further course of the paper.

### **2.3 Incentives for New Technologies to Reduce Losses Better Considered**

The reduction of transmission losses is not directly considered in the current German incentive regulation. The importance of the efficient use of electrical energy is currently primarily seen at the ends of the value chain. A prominent example is the demand side management applied in many manufacturing processes. Ultimately, this measure

is currently generally aimed at limiting the grid load and thus the losses (which lead to heating of the conductors and, in the case of overload, to thermal destruction) to a maximum value. Particularly in the case of new technologies, attention is paid to how the energy losses in the grid can be limited by the use of the technology even before it is deployed across the board. JURADO et al. describe how the grid-side use of electric vehicles in Argentina can be designed in such a way that losses are reduced [16]. Similarly, studies on smart grids are usually guided not only by intelligent control with good integration of renewable generators, which considers possibilities to reduce transmission losses. There are various approaches to this. ZHONG et al. describe a coupon system [17], which in principle can be compared with certificate trading, except that the coupon is a bonus for participation, whereas the emission certificate is more of a malus for the company. There are other incentive systems that are based on the bonus-malus principle and are intended to encourage participation in the smart grid in such a way that losses are reduced. Unfortunately, the regulatory framework that provides an incentive to implement measures is lacking for the possibilities to implement and exploit the potentials to increase transmission efficiency. JACOBSEN has already discussed that a variant would be to expand the German Incentive Regulation Ordinance with an extension factor to include preventable loss energy [7].

### 3 Approach

#### 3.1 Adaptation of the Clearly Outlined Methodological Framework

Incentive regulation is already a powerful method. The challenge is to include key figures in incentive regulation that are aimed at higher transmission efficiency. A clear possibility for this is the introduction of an additional parameter in the regulation formula of the incentive regulation. This approach makes it possible to fall back on an established procedure whose suitability has already been tested and which is accepted by the grid operators. The adaptation of the regulation formula offers the possibility to give an incentive to increase the sustainability of the supply with electrical energy and thus every downstream manufacturing process. Two advantages are created by the inclusion in the regulatory formula. On the one hand, the technical or ecological transmission efficiency has a direct impact on the revenues of the grid operators. Furthermore, an extension parameter in the sense of a transmission efficiency parameter creates a basis to make the technical and ecological efficiency of electrical energy transmission and distribution visible in a key figure for the first time [7]. This key figure can be introduced into the regulatory formula as follows.

$$EO_t = KA_{dnb,t} + \left( KA_{vnb,t} + (1 - V_t) \cdot KA_{b,t} + \frac{B_0}{T} \right) \cdot \left( \frac{VPI_t}{VPI_0} - PF_t \right) \cdot EF_t + Q_t + (VK_t - VK_0) + S_t \quad (1)$$

The individual parameters of this extensive formula are not to be described and discussed further. This is already sufficiently done in Annex 1 to Section 7 German incentive regulation ordinance and in works based on it. The linchpin of the procedure examined in this paper is the expansion factor within the time period  $t$   $EF_t$  with its influence on the revenue cap within the time period  $t$   $EO_t$ . This factor is already anchored

in the regulatory formula. § 10 of the German incentive regulation ordinance states that the expansion factor is currently applied if the comparative parameters defined by the regulatory authority change by a significant amount (at least 0.5%) during the regulatory period. Extension factors for other factors have already been considered. One of the most recent proposals was an expansion factor to reflect the digitization of grid operators. The extension factor for measuring the degree of digitization would provide a direct incentive to increase digitization by influencing the revenue cap. This extension factor has not been implemented. However, it provides a good basis for arguing that it is possible to set expansion factors in such a way that they measure and compare parameters and thus encourage improvements. According to the German incentive regulation, the incentive should always refer to a comparison in the sense of a benchmark.

### 3.2 Linking to Efficiency Parameters of Manufacturing Processes

In manufacturing processes, there is a broad spectrum of methods for assessing the efficiency and sustainability of the processes. Especially in the field of eco-efficiency, there are approaches that can also be applied to the transmission and distribution of electrical energy. However, the goal is first to introduce a key figure that is as simple as possible. The elaboration of a sophisticated indicator should be done at a later stage. As a first step, complicated metrics for evaluating environmental and technical efficiency should be avoided. It is important that grid operators have an obvious incentive to reduce transmission and distribution losses. Therefore, it is useful to start with a comparison of the relative grid losses. The proposal initially involves four steps. The first step is the determination of the relative grid losses.

$$E_{V,rel,t,i} = \frac{E_{V,t,i}}{E_t} \cdot 100 \quad (2)$$

$E_{V,rel,t,i}$  - relative loss energy within the time period  $t$  in % of the grid operator  $i$

$E_{V,t,i}$  - loss energy within the time period  $t$  in kWh of the grid operator  $i$

$E_t$  - amount of energy transmitted within the time period  $t$  in kWh by the grid operator  $i$

The second step involves benchmarking the results of all participating grid operators. The results of the relative loss energy of the grid operators are sorted by size.

### 3.3 Integration into the Regulatory Formula

The two steps just described for the formation of the enhancement factor for the evaluation of the technical ecological efficiency of the grid operators can still be followed by a scaling. It is to be expected that the mere use of the enhancement factor shown in Eq. (2) in Eq. (1) will lead to an over- or under-influence of the revenue cap. For this reason, scaling according to the benchmark may occur, similar to the efficiency value determination in the course of the efficiency value comparison. According to the efficiency value comparison, the grid operator with the lowest  $E_{V,rel,t,i}$  could be assigned a  $EF_t = 1$  and the grid operator with the highest  $E_{V,rel,t,i}$  could be assigned a  $EF_t = 0.6$ . All other grid operators would be assigned a  $EF_t$  linearly ordered according to their  $E_{V,rel,t,i}$ .

## 4 Results and Discussion

### 4.1 Very High Potential for Energy Savings

Previous studies and research have shown that there is a high potential in mitigating transmission losses. Germany alone, transmission losses amount to 27.2 TWh in 2020 [18]. With the current energy mix, this corresponds to emissions of 9.8 megatons of CO<sub>2</sub>. As CO<sub>2</sub> emissions are mitigated to full decarbonization, there will likely be a widespread shift to electric power. It is obvious that this is a high ecological potential, which exceeds the effect of many efficiency measures in industrial manufacturing processes. It can be assumed that without an intervention in the current grid structures and a continuation of the current feed-in and demand structure, an increase in losses can be expected. These large amounts of energy make it clear that electrical energy as a production factor has great potential for overall economic savings in energy, environmentally and climate-damaging emissions, and ultimately high costs. As described, the potential for the individual manufacturing process (depending on the demand for electrical energy) is not high or not high enough to be considered at present, but it is a universal production factor with enormous economic significance and high potential for reducing emissions and energy demand in the economy as a whole.

### 4.2 Transfer of Efficiency Parameters of Manufacturing Processes Difficult

However, adaptations of the energy system with its operating resources must be considered, because the German energy market is not a complete liberalized market. This factor is an obstacle to free pricing, as investors need a security for revenues to invest. Such guarantees can be provided by a (partially) regulated market. This particularity presents both opportunities and challenges for the integration of efficiency improving methods into the energy grid regulation. The basis for this long-term assurance of supply reliability with innovative technologies while guaranteeing secure revenue structures is provided by the German Energy Act (German: *Energiewirtschaftsgesetz – EnWG*) [19]. Ultimately, this means that the same methods cannot be used to evaluate and influence efficiency in manufacturing processes without further adaptations. The methods and tools used must be aligned in their effect with the goals of the German Energy Act §1 and equally stimulate a reliability of supply, environmental competitiveness, acceptance, value for money and efficiency [20].

### 4.3 Precise Definition And Shaping of the Factor - A Long-Term Process

In the introduction to this paper, it was described that the incentive for more grid-efficient energy procurement in manufacturing processes must come from the grid operators. To achieve this, the grid operators themselves must have a higher incentive to reduce grid losses. For the creation of such an incentive, an objective key figure is required. In Sect. 3, it became clear that a direct incentive, as it exists in industrial companies for increasing the efficiency of manufacturing processes, cannot be implemented when influencing transmission losses within the electric power supply grid. Rather, a factor must be found that attacks the current regulatory methodology. The factor presented here is certainly



capable of generating a corresponding incentive. For the actual implementation, further analyses and simulations regarding the effect of the factor are important. Especially with regard to the background of the smart grid approach and an increasing digitalization of the energy grid for a target-oriented monitoring of the operating parameters, a breeding ground for efforts to increase the efficiency of energy transmission and distribution can be seen. Ultimately, electrical energy is a universal production factor whose importance for most manufacturing processes will increase. Thus, increasing the efficiency of energy transmission has a direct positive impact on the footprint of most manufacturing processes. This paper shows a potential method for the use of an efficiency indicator for energy transmission. Future research questions need to clarify how this indicator should be designed in detail.

## References

1. Schwab, A.J.: Electric power systems: generation, transmission and distribution of electric power. German: Elektroenergiesysteme: Erzeugung, Übertragung und Verteilung elektrischer Energie, 5th edn. Springer, Heidelberg (2017). <https://doi.org/10.1007/978-3-662-55316-9>
2. Narayan, P.K., Prasad, A.: Electricity consumption–real GDP causality nexus: evidence from a bootstrapped causality test for 30 OECD countries. *Energy Policy* **36**(2), 910–918 (2008). <https://doi.org/10.1016/j.enpol.2007.10.017>
3. Behrens, C.-U., Kirspel, M.: Fundamentals of Economics: Introduction, German: Grundlagen der Volkswirtschaftslehre: Einführung, 2nd edn. Oldenbourg, München (2001)
4. Götze, U.: Cost Accounting and Cost Management, German: Kostenrechnung und Kostenmanagement, 6th edn. Springer, Berlin (2022)
5. Jacobsen, B., Teuscher, J.: Power quality market - unbundling for more flexibility in the provision of power quality. In: Gesellschaft, E. (ed.) ETG-Fachbericht, ETG-Kongress 2021: Das Gesamtsystem im Fokus der Energiewende: 18–19 Mai 2021, Online-Veranstaltung, Berlin, Offenbach: VDE Verlag GmbH, pp. 389–394 (2021)
6. Domagk, M., et al.: Probabilistic comparison of methods for calculating harmonic current emission limits. In: 2017 IEEE Manchester PowerTech, Manchester, United Kingdom, 18–22 June 2017 (2017)
7. Jacobsen, B.: Transition of energy system by regulating of power quality for efficiency improvements. *Procedia CIRP* **105**, 507–512 (2022). <https://doi.org/10.1016/j.procir.2022.02.084>
8. Heck, V.: Regulation of the electricity market in Germany, München (2006). <https://www.ecn.nl/bitstream/10419/166877/1/ifo-dice-report-v04-y2006-i2-p30-38.pdf>
9. Eucken, W., Eucken-Erdsiek, E., Hensel, K.P. (eds.) Principles of economic policy, German: Grundsätze der Wirtschaftspolitik, 7th edn. Mohr Siebeck, Tübingen (2004)
10. Fallier, S.F.: Quality incentive regulation of electric distribution networks: recommendations for action for a further development of the german regulatory approach, German; Qualität-sanreizregulierung der elektrischen Verteilnetze: Handlungsempfehlungen für eine Weiterentwicklung des deutschen Regulierungsansatzes. Zugl.: Stuttgart, Univ., Diss., 2013, 1st edn. Lohmar: Eul (2013)
11. Modarres, M.: Reliability Engineering and Risk Analysis. CRC Press (2009)
12. Munasinghe, M.: The economics of power system reliability and planning. Baltimore and London: The Johns Hopkins University Press (1979). [https://www.researchgate.net/profile/mohan-munasinghe/publication/37881951\\_the\\_economics\\_of\\_power\\_system\\_reliability\\_and\\_planning\\_theory\\_and\\_case\\_study/links/56e173f408aacc09a8bc07a74/the-economics-of-power-system-reliability-and-planning-theory-and-case-study.pdf](https://www.researchgate.net/profile/mohan-munasinghe/publication/37881951_the_economics_of_power_system_reliability_and_planning_theory_and_case_study/links/56e173f408aacc09a8bc07a74/the-economics-of-power-system-reliability-and-planning-theory-and-case-study.pdf)

13. Groscurth, H.-M., Bode, S.: The quantitative market model: a proposal for creating or securing investment incentives for the expansion of renewable energies in electricity generation using market-oriented instruments, German: Das Mengen-Markt-Modell: Ein Vorschlag zur Schaffung bzw. Sicherstellung von Investitionsanreizen beim Ausbau der erneuerbaren Energien in der Stromerzeugung unter Nutzung marktorientierter Instrumente, arrhenius Institut für Energie- und Klimapolitik, Hamburg (2011)
14. Diekmann, J., Leprich, U., Ziesing, H.-J.: Regulation of electricity grids in germany: economic incentives for efficiency and quality of a sustainable grid infrastructure, German: Regulierung der Stromnetze in Deutschland: Ökonomische Anreize für Effizienz und Qualität einer zukunftsfähigen Netzinfrastruktur. Düsseldorf: Hans-Böckler-Stiftung (2007). <http://hdl.handle.net/10419/116430>
15. Diekmann, J., Ziesing, H.-J., Leprich, U.: Incentive regulation for employment and network investments, German: Anreizregulierung für Beschäftigung und Netzinvestitionen, Berlin: DIW (2006). <http://hdl.handle.net/10419/129152>
16. Jurado, A., Vinson, E., Nicchi, F.: Regulatory incentives for reducing losses and increasing network utilization when plug-in electric vehicles are connected in Argentinian distribution systems. In: CIRED 2021 - The 26th International Conference and Exhibition on Electricity Distribution, Online Conference, pp. 2954–2958 (2021)
17. Zhong, H., Xie, L., Xia, Q.: Coupon incentive-based demand response (CIDR) in smart grid. In: IEEE Power and Energy Society general meeting, San Diego, CA, USA, San Diego, CA, 22–26 July 2012, pp. 1–6 (2012)
18. Bundesnetzagentur, Monitoring report 2021: German: Monitoringbericht 2021, Bonn (2021)
19. Energiewirtschaftsgesetz: EnWG (2018). Accessed 14 May 2019
20. Jacobsen, B.: Green flexibility market – platform development for system services using fuel cells. *Procedia CIRP* **105**, 158–163 (2022). <https://doi.org/10.1016/j.procir.2022.02.027>

**Open Access** This chapter is licensed under the terms of the Creative Commons Attribution 4.0 International License (<http://creativecommons.org/licenses/by/4.0/>), which permits use, sharing, adaptation, distribution and reproduction in any medium or format, as long as you give appropriate credit to the original author(s) and the source, provide a link to the Creative Commons license and indicate if changes were made.

The images or other third party material in this chapter are included in the chapter's Creative Commons license, unless indicated otherwise in a credit line to the material. If material is not included in the chapter's Creative Commons license and your intended use is not permitted by statutory regulation or exceeds the permitted use, you will need to obtain permission directly from the copyright holder.





# User-Centric Energy Efficiency Optimization for Machining

Thore Gericke<sup>(✉)</sup>, Volkmar Thomsen, Nik Schwichtenberg, and Alexander Mattes

Fachhochschule Kiel, CIMTT, Schwentinestr. 13, 24149 Kiel, Germany  
{Thore.Gericke, Volkmar.Thomsen, Nik.Schwichtenberg,  
Alexander.Mattes}@fh-kiel.de

**Abstract.** A user-centric end-to-end machining optimization approach for increased energy efficiency according to the major goal of carbon free production, is presented. By doing so the two major challenges for medium size companies get addressed. First data acquisition with sensors, which only require minimum investment cost by using machine-internal measured values and additional machine parameters. On example applications, it is shown how this combination enables transformation from parameter based to tool load based optimization. This foundation ensures the continuous selection of the process window with highest performance effectiveness of machine tool and cutting tool, regardless if machining anomalies occur. Second a collaborative assistance system, which provides to the machine operator the option for input his specific experience and knowledge, thus making personal contribution to energy savings tangible. Thereby the carbon footprint per manufactured product component gets minimized.

**Keywords:** Energy efficiency · Process optimization · Torque measurement · Internal machine data · Machine calibration · Data visualization · Human-machine interface

## 1 Introduction

Due to increasing demands in terms of energy efficiency and reduction of CO<sub>2</sub> emissions, the metal processing industry is also subject to growing pressure. Because this branch is responsible for around 23% of Germany's total annual emissions (in 2019, 183 m t CO<sub>2</sub>e), particular attention is being paid to this sector [1]. In addition, batch sizes are decreasing while the number of variants is increasing. In order to be able to continue to produce competitively, this requires flexible and at the same time energy-efficient production [2].

In this paper, two sections are considered to contribute to efficiency increase and pollutant reduction in the mentioned industrial sector. The first section analyzes in which form relevant data can be obtained during machining processes. In addition, the quality of the respective machine-internal process data is considered in order to allow meaningful conclusions to be drawn about the real machining process.

The second section focuses on the human being in the form of the machine operator in order to take optimal advantage of his experience and qualifications. For this purpose, the machine-internal data obtained is to be processed and visualized by means of an assistance system in such a way that it can be quickly perceived by the operator and decisions can be made independently to increase the efficiency of the machine and consequently of the process.

## 2 Measurement of Internal Machine Data

In order to be able to evaluate machining processes on the basis of machine-internal data, it is first necessary to consider which data can be called up for process optimization via the machine tool control and what consequently significance they offer. The use of machine-internal data is justified by the challenge that installed machine tools of existing production lines can only be retrofitted with external measuring sensors at high investment costs. This poses a major economic hurdle, especially for medium-sized companies, and is often considered too high financial risks. In addition, there is a risk that complex measurement setups at laboratory level, such as force plates based on piezo-electric elements, will negatively influence the actual machining process, falsify occurring process forces and limit the flexible use of the machine tool. Furthermore, a high level of experience and qualification is required to evaluate the data obtained and to implement measures for process optimization.

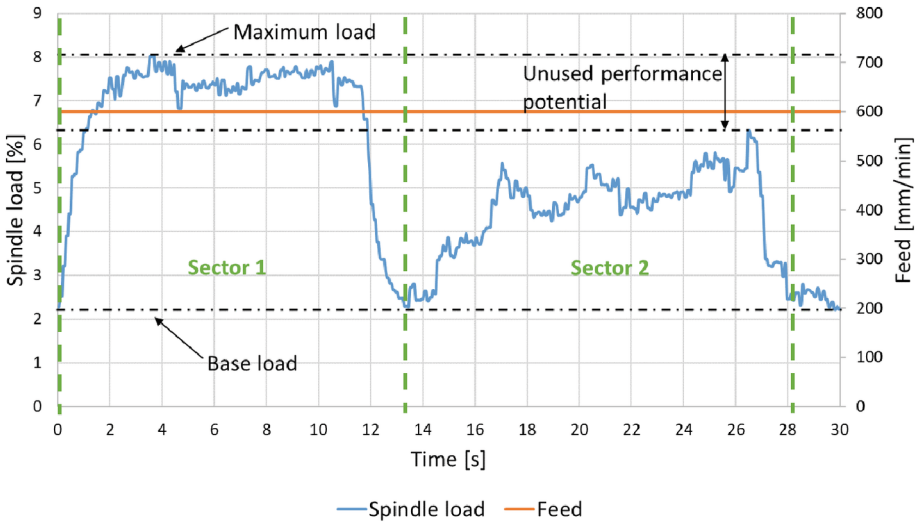
The general approach is therefore to evaluate and present the data provided in such a way that the findings can be used to increase efficiency and thus reduce CO<sub>2</sub> emissions. Relevant machine-internal data can be drive currents of spindle motors, but also current positions, speed or acceleration values of individual drive axes. Depending on the control system, these are measured in the position control cycle at the respective frequency inverter of a drive, sent to the Numerical Control Unit (NCU) and finally output at the Human-Machine Interface (HMI) or external measuring computer.

### 2.1 Suitability of Internal Machine Data for Process Optimization

Because monitoring the drive power of spindle and feed drives to protect against overload is standard equipment on many machine tools, it is an obvious approach to check their suitability for process monitoring and optimization [3].

Own investigations showed that the evaluation of the torque-forming current consumption of the axis drives is not suitable for the evaluation of the loads arising in the process, such as cutting, feed and passive forces. On the test machine used, type GROB G350, it was noticed, that the holding currents caused by the raised machine table are many times higher than the current changes caused by machining. However, the situation is different when evaluating the drive power of the spindle drives. Although the basic load, which occurs when the spindle is rotating without machining, has to be compensated, current changes and thus torques resulting from the machining process can be clearly detected.

Figure 1 shows the spindle load during a roughing milling process. In this case, the tool utilization in sector 2 is below the referencing maximum from sector 1, which



**Fig. 1.** Spindle load curve of typical roughing milling process

indicates an unused performance potential. The data sheet shown was generated during data collection at industrial companies and thus represents real manufacturing scenarios. In the investigated workpiece, this revealed potentials that reduce the machining time by around 13%. Applied to the company's entire product portfolio, this would result in annual savings of around 18 MWh and 8 t CO<sub>2</sub> per machine tool, assuming 3-shift operation on 6 working days, an average machine power consumption of 18.8 kW and a CO<sub>2</sub> emission factor of 438 g/kWh (in 2019) [4, 5].

The tests proved a correlation between the real cutting torque and the current consumption of the spindle drive called up internally in the machine. However, these depend on the process parameters as well as on the spindle type and parameterization, which complicates the comparison between different machine tools.

### 3 Calibration Methods for Spindle Drives

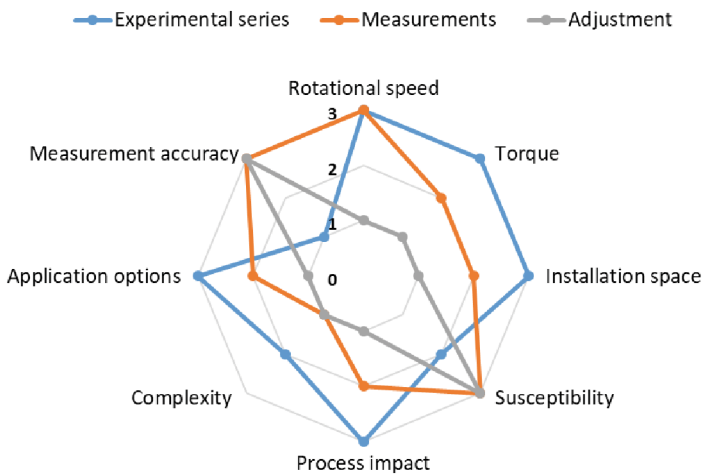
In order to realize the comparability between processes and machine types, a transformation from a parameter- to a load-controlled process evaluation has to be carried out. This is to be achieved by means of a calibration procedure in which the characteristics of various spindle designs are recorded and a calculation methodology for the machine-internal data is created. In view of the fact that the calibration procedure has to be carried out on every existing machine tool and that acceptance in the industry must be ensured for this purpose, the implementation should not be associated with a high expenditure of time and machine downtimes. This enables the transfer of machine-specific data to an absolute reference system, which allows comparability and thus transferability.

For the necessary calibration of the current consumption of the machine internally derived spindle in the manufacturing production environment, various methods were

investigated and checked for their suitability. Three approaches have been defined for the basic mode of action of the process:

**Measurements:** In this case, the torsional moment generated in the machining process is measured directly and finally compared with the current consumption formed out of machine-internal data. This approach includes among others strain gauges, which measure the deformations resulting from the process forces and are either used in sensory tool holders or integrated directly into the corresponding tool spindle [6]. **Adjustment:** In these processes, a clearly defined torque is applied to the tool spindle. This can be realized by calibrated eddy current, hysteresis brake or agitators. Eddy current brakes are used, for example, on engine test benches to apply a defined load to the units [7].

**Experimental series:** The third category consists of defined metal cutting processes in which the machining forces and torques that occur have been determined beforehand. These test processes are implemented on the respective machine tool and the resulting recorded spindle currents are then compared with the target values.



**Fig. 2.** Suitability of the criteria for calibration methods, Legend: 1 = low/bad; 2 = medium; 3 = high/good

Different requirements are placed on the corresponding calibration procedure with regard to application possibilities and process influence. On this basis, 8 criteria were developed and evaluated according to the approaches in Fig. 2, among others: **Rotational speed:** Scalability in terms of speed; **Process impact:** Influence on the real machining process; **Application options:** Applicability to different machining processes.

However, since the various criteria established cannot be regarded as equivalent in terms of weighting, they must first be ranked by means of a hierarchy. This was realized with a 3-stage pairwise comparison through which the corresponding weighting factors were created. These were used to offset the respective values in Fig. 2. This was calculated with the following formula:

$$\text{Rating Criteria} * \text{Weighting factor} = \text{Evaluation number}$$

The resulting overall evaluation including the weighting factors is shown in Table 1 and thus evaluates the suitability of the respective approaches “Experimental series”, “Measurements” and “Adjustment” explained before.

**Table 1.** Evaluation including weighting factor

Criteria	Experimental series	Measurements	Adjustment	Weighting factor
Rotational speed	0.48	0.48	0.16	16%
Torque	0.43	0.29	0.14	14%
Installation space	0.21	0.14	0.07	7%
Susceptibility	0.25	0.38	0.38	13%
Process impact	0.48	0.32	0.16	16%
Complexity	0.18	0.09	0.09	9%
Application options	0.43	0.29	0.14	14%
Measurement accuracy	0.11	0.32	0.32	11%
<b>Sum:</b>	2.57	2.30	1.46	100%

The overall evaluation shows that, with regard to the selected criteria, the “Experimental series” with 2.57 out of a maximum of 3.0 evaluation points is the most suitable for representing practical machining processes and for ensuring the necessary transferability to other machine types and configurations.

## 4 User Requirements

In addition to the technical challenges of collecting and processing machine data, such as a multitude of controls and machines, and the necessary measured value qualities, there are also the human requirements. In particular, the extensive implicit process knowledge of experienced and well-trained machine operators can only be used in a harsh production environment if an intuitive and efficient communication option between machine and user is realized. This must provide feedback on potential savings, stable process sections and prediction of change effects. At the same time, communication among all actors requires the consideration of systemic factors. This requires the collection of objective process and measurement data as well as information on selected optimization approaches and boundary conditions.

For all applications of optimization tools at the shop floor level, it is therefore crucial that the entire user experience is consistently practice-oriented. Only if this is ensured will an assistance system be sufficiently accepted by employees on the shop floor, even in areas with high performance pressure [8]. Requirements analyses carried out in manufacturing companies to date have identified one application area as particularly serious, from which specific user requirements arise.

Especially for productions of small and medium batch sizes, no elaborate studies for the optimal setting of a process are realized. The decisive factor is often the experience of the skilled machine operator. Manufacturing processes are usually optimized only as far as necessary to be able to produce economically. Here, a data basis is missing to make objective statements about the tool utilization in a process. A target group-oriented visualization of existing tool loads already opens up significant optimization potentials within a process.

In addition, due to the prevailing time and performance pressure, solutions and results achieved are rarely documented in such a way that other employees can apply this expertise to similar problems. Therefore, documentation close to the machine, at best fully automatic, must be able to record process parameters and malfunctions. This secured expertise increases productivity and permanently secures the company the corresponding process knowledge of the executing employees.

These requirements can be met with an optimization system that provides in-machine sensor data, enabling objective process evaluations, while also having an effective human-machine interface that allows employees to combine their expertise and the available measurement data. In this way, production processes can be optimized efficiently, taking into account all necessary factors.

## 5 UX-Example

The following graphical user interface (see Fig. 3) shows the optimization of the productive time of a milling process as a use case with the largest identified savings potentials. Human-centered design takes place through the four phases of identifying the user context, specifying user requirements, creating design solutions and evaluating the design solutions [9].

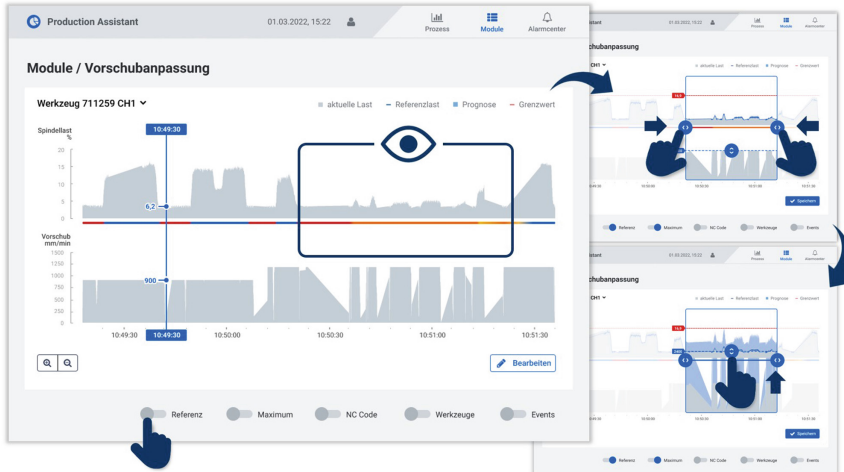
The increase in efficiency is achieved by utilizing the tools as evenly as possible throughout the entire production process. Necessary load changes are realized by local feed adjustments. Research and feedback from machine operators has shown that the particular information required highly depends on the process and product. In this way, the irrelevant data is hidden in order to provide the machine operator only with the essential information for process optimization. For example, the spindle speed is an irrelevant parameter in milling processes and is not shown in the dashboard in this case. The exemplary calculation of time, energy and CO<sub>2</sub> savings, on the other hand, has a motivating effect and is therefore presented more intensively.

An optimization tool is available for the interaction, which narrows down the optimization range by defining a start and end point. The machine operator uses his extensive knowledge to include existing process restrictions in the optimization.

A visualization of the previously reached safe spindle load maximum serves as a reference line. Using drag-and-drop touch gestures, the programmed feed rate is adjusted locally by the operator. The expected effects on the spindle load are calculated using an approximate calculation according to Kienzle. By adjusting the color-coding, the operator receives direct feedback on the optimization potential. The granularity of the process section adjustment depends on the time available and the cost-benefit ratio of the process.



Through the user's intervention in the pre-programmed process and the real-time prediction of its adaptation by the application algorithm, the user and the algorithm learn from each other in equal measure. Through feedback, users learn to refine their suggestions. The collected data can be used in the long term for partial automation, which enables a transfer from an experience- and parameter-controlled to a load-controlled process design and thus permanently optimal operating conditions.



**Fig. 3.** Assistant shows need for optimization (left), user defines action frame (top right) and performs spindle load adjustment by means of feed rate adjustment, impact prediction takes place immediately (bottom right)

## 6 Summary and Outlook

These ongoing investigations carried out have shown that machine-internal data are suitable for process evaluation. To be able to transfer processes to other machine tools and thus make production much more flexible, the corresponding machine-internal data must be transferred to an absolute reference system by means of calibration procedures. The experimental series to be developed for this purpose must represent different processing scenarios and ensure the scalability of different parameters. Process monitoring and optimization based on machine-internal data offers an opportunity for metal-cutting processes to increase efficiency by utilizing existing performance reserves.

The appropriate visualization of this data makes it possible to use it effectively for process optimization by making optimal use of the machine operator's knowledge and presenting the required information as comprehensibly as possible. Care must be taken to ensure that the visualization can be flexibly adapted to the respective target group to ensure that the crucial information is conveyed in a comprehensible manner.

In prospect, the various approaches are aimed at a wide range of stakeholders, from the requirements for machine-internal data and their interpretation to visualization for

the user. This end-to-end approach creates a holistic view of the value chain of manufacturing processes. This is also shown by initial investigations in additive direct energy deposition processes and hand-guided welding processes. In this process, the various relevant process data, such as feed rate of the application nozzle or acceleration of the manual welding gun are examined and analyzed using an AI application. Here, targeted process monitoring can possibly also reduce the necessary quality assurance by means of costly and destructive testing and further increase process reliability.

### Acknowledgments.



This research is funded by the Gesellschaft für Energie- und Klimaschutz Schleswig-Holstein GmbH (EKSH) under projects 8/12-45 and 8/12-53.

### References

1. Günther, D., Gniffke, P.: Berechnung der Treibhausgasemissionsdaten für das Jahr 2021 gemäß Bundesklimaschutzgesetz, Umweltbundesamt, Dessau-Roßlau (2022)
2. Denkena, B., Tönshoff, H.K., Uhlich, F., Kiesner, J.: Quality assurance using enriched process information. *TM - Technisches Messen* **86**(9), 522–527 (2019)
3. Gittler, T., Gontarz, A., Weiss, L., et al.: A fundamental approach for data acquisition on machine tools as enabler for analytical Industrie 4.0 applications. In: 12th CIRP Conference on Intelligent Computation in Manufacturing Engineering, Gulf of Naples (2018)
4. Holkup, T., Vyroubal, J., Smolik, J.: Improving energy efficiency of machine tools. In: 11th Global Conference on Sustainable Manufacturing, Berlin (2013)
5. Icha, P., Lauf, T., Kuhs, G.: Entwicklung der spezifischen Treibhausgas-Emissionen des deutschen Strommix in den Jahren 1990 – 2021. Umweltbundesamt, Dessau-Roßlau (2022)
6. Qin, Y., Zhao, Y., Li, Y., Zhao, Y., Wang, P.: A novel dynamometer for monitoring milling process. *Int. J. Adv. Manuf. Technol.* **92**(5–8), 2535–2543 (2017). <https://doi.org/10.1007/s00170-017-0292-3>
7. José Rosa Nunes, A., Miguel Ribeiro Proença Brojo, F.: Designing an eddy current brake for engine testing. In: International Congress on Engineering – Engineering for Evolution, vol. 5, no. 6, pp. 743–756 (2020)
8. Nelles, J., Kuz, S., Mertens, A., et al.: Human-centered design of assistance systems for production planning and control: the role of the human in Industry 4.0. In: IEEE International Conference on Industrial Technology (ICIT), Taipei (2016)
9. EN ISO 9241-220:2019 Ergonomics of human-system interaction - Part 220: processes for enabling, executing and assessing human-centred design within organizations. Beuth Verlag, Berlin (2020)

**Open Access** This chapter is licensed under the terms of the Creative Commons Attribution 4.0 International License (<http://creativecommons.org/licenses/by/4.0/>), which permits use, sharing, adaptation, distribution and reproduction in any medium or format, as long as you give appropriate credit to the original author(s) and the source, provide a link to the Creative Commons license and indicate if changes were made.

The images or other third party material in this chapter are included in the chapter's Creative Commons license, unless indicated otherwise in a credit line to the material. If material is not included in the chapter's Creative Commons license and your intended use is not permitted by statutory regulation or exceeds the permitted use, you will need to obtain permission directly from the copyright holder.





# Method for Evaluating and Identifying Energy-Efficient Process Chains for the Manufacturing of Press Hardening Tools Based on the Deming Circle

Anja Rautenstrauch<sup>1</sup> (✉), Larisa Markov<sup>1</sup>, and Verena Kräusel<sup>1,2</sup>

<sup>1</sup> Faculty of Mechanical Engineering, Institute for Machine Tools and Production Processes, Professorship for Forming and Joining, Technische Universität Chemnitz, Reichenhainer Str.70, 09126 Chemnitz, Germany

<sup>2</sup> Fraunhofer Institute for Machine Tools and Forming Technology, Reichenhainer Straße 88, 09126 Chemnitz, Germany

**Abstract.** In response to rising energy demand, climate change and resource scarcity, the German government has set guiding targets for the transformation of energy systems by 2050. One goal is to increase energy efficiency in order to halve the demand for energy. An important instrument for increasing energy efficiency and reducing energy costs is the energy audit. By determining how much energy is consumed in which areas of the company, it is possible to identify where there is potential for savings. This paper presents an evaluation method for identifying energy-efficient process chains for the production of press hardening tools. The evaluation method is based on the Deming Circle and is intended to serve as a supporting tool for the energy audit. The method enables the analysis and evaluation of energetic variables of a process chain and is designed for manufacturing companies.

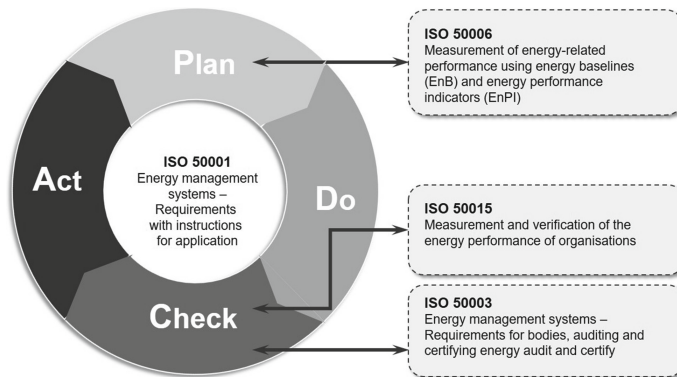
**Keywords:** Energy Management System · Energy consumption · (PDCA) cycle

## 1 Introduction

The increasing demand for energy, climate change and scarcity of resources are major challenges of our time. As a reaction to the drastically increasing environmental problems, this topic has developed into an independent policy area and demands corresponding ecology-oriented information and decision-making instruments [1].

DIN EN ISO 50001 is an instrument that provides the normative basis for the introduction, operation and continuous optimisation of an energy management system. The aim of this document is to assist companies in continuously improving energy-related performance, including energy efficiency, energy use and energy consumption. To this end, the standard requires the implementation of processes that ensure effective and measurable improvement. The organisational units shall collect, analyse and evaluate

its energy data and systematically identify energy potentials from it. To ensure continuous optimisation, these processes are subdivided according to the Deming Circle, the Plan-Do-Check-Act (PDCA) cycle. In addition, there are other standards of the ISO 5000 family (Fig. 1) for a comprehensive explanation of the individual processes and for support in implementing the requirements of DIN EN ISO 50001 [2].



**Fig. 1.** The ISO 50000 family and the Plan-Do-Check-Act (PDCA) cycle.

The standards are based on the principle of uniform standardisation, are formulated very generally and do not contain any industry-specific information. However, each industry has certain specifics that must be taken into account in order to set up and introduce an energy management system. For this reason, this article deals with the toolmaking industry, in particular with the production of press hardening tools. The production of thermo-mechanically stressed tools is associated with energy- and resource-intensive manufacturing processes. With the help of the developed method, the currently existing deficits regarding the use of energy and resources in tool production are to be shown comparatively between the conventional and an alternative route of tool production.

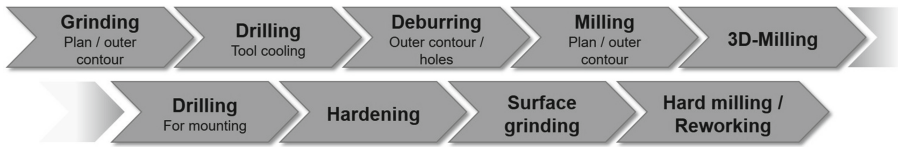
## 2 Production of Press Hardening Tools

For classical press hardening, the cooling effect of the thermal and mechanical highly stressed tool is of particular importance. In order to realise a stable process, the heat must be dissipated evenly and quickly from the component, so that the cooling structure should be arranged as close to the surface as possible. The insertion of the cooling channel structures can be done with different concepts: cooling holes, cast-in cooling tubes, sand core casting, additively manufactured cooling structures or shell structures.

### 2.1 Process Chain for Manufacturing the Tool with Drilled Cooling Channels

In industry, cooling with the use of deep-hole drilled cooling channels is most frequently used. This solution is comparatively simple to manufacture, robust in use and enables a high degree of automation in production. In order to map the geometry of the tool

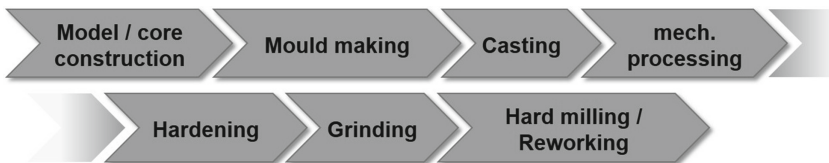
and the cooling system, these are divided into segments and provided with holes. The size of the individual segments is determined by the complexity of part and thus also the tool geometry as well as the maximum drilling depth. The disadvantage of this segmented construction is the required sealing of the segments, taking into account the temperature-related expansion. Another disadvantage is the formation of so-called hot spots with insufficient cooling in the case of very complex geometries of the tool, especially in radius areas. The manufacturing of tools with drilled cooling systems is characterised by a high proportion of machining. After milling, drilling and deburring, the tool is hardened to increase its mechanical resistance and then hard-milled to its final geometry and finished (Fig. 2) [3].



**Fig. 2.** Process chain for manufacturing the tool with drilled cooling channels, based on [4]

## 2.2 Process Chain for Manufacturing the Tool with Cast Cooling Channels/sand Core Casting

Another manufacturing for cooling channels option is the sand core casting process. With this method, cooling close to the contour can be realised with high material utilisation. The process chain begins with pattern making and sand core production. The sand core represents the complete cooling system and thus reproduces the inner contours of castings. The core consists of sand and a chemical binder, has a high strength and should withstand the pressure as well as the high temperature until the shell solidifies. The model is moulded with the compacted sand, supplemented with the sand core and then cast. After cooling and demoulding, mechanical processing takes place. If necessary, the castings are further hardened to increase the strength of the tool. After a final grinding, hard milling and reworking, the tool parts are ready for further assembly (Fig. 3) [4].

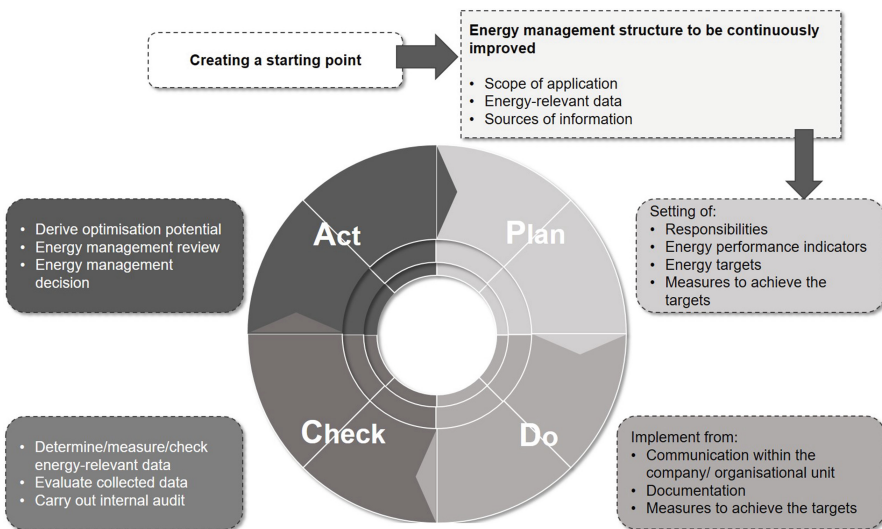


**Fig. 3.** Process chain for manufacturing the tool with cast cooling channels/sand core casting, based on [4]

### 3 Method Devised

The method developed is used to evaluate and identify energy-efficient process chains for the manufacturing of press hardening tools and identifies existing deficits in terms of energy and resource use. As a result, the objective is to increase energy efficiency and reduce energy costs. For this purpose, a comprehensive analysis of the energy consumption and the development of possible savings potentials is carried out. All the information collected is used to carry out the energy audit.

The aim of the method is to create an energy management structure based on existing organisational processes that can be used to evaluate manufacturing strategies for the manufacturing of thermally and mechanically highly stressed tools. When introducing the method, the framework conditions must first be created in order to be able to carry out an evaluation. For this purpose, the scope of application, the responsibilities, the energy-relevant data to be included and the available sources of information must be defined. Building on the basis created, the assessment and identification of the manufacturing process chains can begin. For this purpose, the PDCA cycle is used to achieve a continuous improvement of the set goals and target values (Fig. 4).



**Fig. 4.** Method for evaluating and identifying energy-efficient manufacturing process chains [ff. 2]

## 4 Evaluating and Identifying Energy-Efficient Process Chains

### 4.1 Scope of Application

The investigations are to be carried out for the manufacturing of a thermal and mechanical highly stressed forming tool for the press hardening of sill components. The process

chains for manufacturing a forming tool with drilled cooling channels and a forming tool in which the cooling channel structure was introduced by means of sand core casting are to be compared with each other (Fig. 2; Fig. 3). The tools were both made from a hot work tool steel 1.2367. The mechanical processing was carried out on a milling machine Hermle C 400 and a grinding machine ELB Perfekt 6 SPS (Fig. 5).

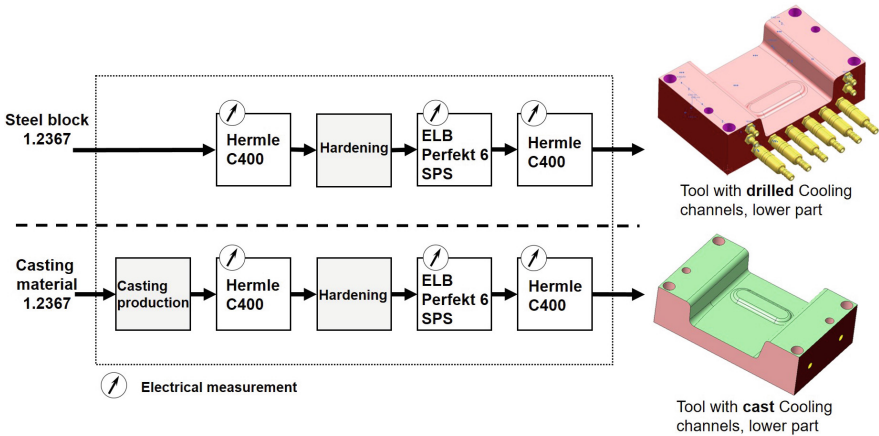


Fig. 5. Schematic representation of the scope of application

### 4.2 Planning Phase

The first step is to define target values that can be used for an evaluation. It is important to pay attention to the available data:

- The total energy consumption of the process, which represents the integration of the absorbed active power  $P(t)$  within a time period  $T$  [5].

$$W_{system/process} = \int_{T_0}^{T_n} P(t)dt \tag{1}$$

- Energy efficiency, which describes the ratio or other quantitative relationship between an achieved output or yield of services, goods, commodities or energy  $E_{id}$  and the energy used  $E_{real}$  [2].

$$\eta = \frac{E_{id}}{E_{real}} \tag{2}$$

The energy driver describes the plant/machine or a process that has the highest energy consumption  $W_{system/process}$  along a manufacturing task or process chain [5].

$$W_{ET} = \max(W_{system/process}) \tag{3}$$



- The energy consumption peak/peak load  $P(t)_{max}$  describes a high power demand occurring for a short time [7].

Furthermore, the measures for necessary adjustments of the energy demand of the manufacturing processes are defined in this section. This is influenced by process-specific data, such as the technology, the type, the year of construction or the manufacturer of the machine/plant. In addition, the states taken, their temporal relationships and the temporal sequence of the states are to be considered as factors influencing the energy demand and the temporal sequence of the states is relevant. The measures can include various instruments such as short-term or medium-term adjustment of process starts, machine occupancy, order sequence, break or shift times, storage of energy or even change of energy source. These have a wide variety of control variables such as shift times, break times, maintenance times, machining times, start-up times, set-up times, daily requirements or the number of variants at their disposal [8]. In addition, new processes or process chains can be introduced to achieve the objectives.

The concern of every company is the reduction of energy consumption. For this purpose, the energy consumption of two process chains for manufacturing of a thermal and mechanical highly stressed forming tool, by means of cast cooling channels/sand core casting and by means of drilled cooling channels, is to be determined and compared in this example. The process steps of both process chains are determined by the selected field of application (Fig. 2, Fig. 3).

### 4.3 Implementation Phase

The measures described are implemented in the company during this phase. All determinations and implemented measures must be precisely documented and communicated. The documentation of all activities carried out and the results achieved serve as evidence. In this way, it can be proven and understood what has been achieved. Within the framework of a management system, environmentally relevant records should be filed in an orderly and protected manner. Furthermore, the involvement of employees in the energy management system must be ensured through regular meetings. For internal and external communication, enquiries, complaints, communication with customers, suppliers and authorities must be included.

### 4.4 Check-Phase

In the check phase, the effectiveness of the measures is checked with regard to the achievement of target values or energy goals. This involves monitoring and measuring the defined target values, which should be carried out regularly. For this purpose, the energy-relevant data must be recorded and evaluated. The results should be documented in a comprehensible way and included in the performance evaluation.

A voltage divider, which was developed by the TU Chemnitz, was used to measure the voltage. The current was measured using current clamps such as ELCONTROL (clamp C 1000/I), HT97U (HT Instruments), MN71 (Chauvin Arnoux) and VOLTcraft AC 200. An NI USB6259 measuring amplifier was used for the measurements. The recorded energy data were evaluated in the jBEAM programme. The energy demand of the heat

treatments was calculated via the amount of heat to be introduced. This is calculated from the specific heat capacity  $c$ , the tool mass  $m$  and temperature change  $\Delta T$ .

$$Q = c \cdot m \cdot \Delta T \quad (4)$$

Table 1 summarises the process steps of the considered process chains and the results of the measurements. The overview shows the energy-intensive processes depending on the production plant. It is possible to reduce the energy consumption of these processes by adjusting the process settings. The process chain for manufacturing the press hardening tool with cast-in cooling channels has the lower energy requirement as a result.

**Table 1.** Comparison of the total energy demand of the processes, tool lower part

Process step	Production line	$W_{Anlage/Prozess}$ , [kWh]	
		Drilled cooling channels	Cast-in Cooling channels
<b>Casting production</b>	Assumption	–	6,17
Milling (clamping surface, face milling, outer contour)	Hermle C400	4,58	2,19
Drilling cooling channels	Hermle C400	2,66	–
Deburring (outer contour, holes)	Hermle C400	2,07	2,07
Milling (face milling, external contour)	Hermle C400	2,25	–
3D milling, rough contour	Hermle C400	4,29	–
3D milling, fine contour	Hermle C400	4,99	4,99
Countersink M10	Hermle C400	0,11	0,11
Aufnahmebohrung	Hermle C400	7,19	7,19
<b>Hardening</b>	Assumption	3,78	3,78
Grinding (bottom and view side)	ELB 6 SPS	3,31	3,31
Hard milling	Hermle C400	0,87	0,87
Chamfer insertion	Hermle C400	0,28	0,28
Rework	Hermle C400	0,78	0,78
3D milling, fine contour	Hermle C400	2,72	2,72
<b>Total</b>		<b>39,88</b>	<b>34,46</b>

## 4.5 Act-Phase

The Act phase serves to continuously improve energy consumption in manufacturing and the energy management system. The first step is to derive optimisation potentials. This enables an interpretative evaluation of collected data and the derivation of optimisation potentials. These suggestions form the basis for setting new goals for the next cycle to evaluate the application area under consideration. Furthermore, all necessary information/data for an energy management review and decision are compiled. This review is a presentation of the results, the analysis and evaluation of the considered application area as well as an interpretative interpretation of solution proposals. It represents an important basis for communication with the management and, if necessary, serves as a report for an external energy auditor.

As a result of the analysis and evaluation of the two production process chains considered, the process chain for manufacturing the forming tool using sand core casting shows the lowest energy consumption. It thus represents the potential for energy-efficient implementation and is presented as a proposal in the energy management review. The decision is incumbent on the management.

## 5 Summary and Outlook

In this article is presented a method for evaluating and identifying energy-efficient process chains for the manufacturing of press hardening tools based on the PDCA cycle. The method was used and validated for a comparison of the process chains with drilled and cast cooling channels. The result showed that by documenting the individual phases, the evaluation was recorded in a comprehensible and transparent manner for the energy management review and forms a good basis for decision-making. The described procedure using the PDCA cycle enables a standardisation and introduction of an energy management system with continuous improvement of the energy consumption of the considered application area.

**Acknowledgment.** The article was written as part of the joint project “Identification of energy- and resource-efficient process chains for the production of thermo-mechanically stressed tools by means of a holistic evaluation method – reProTools” with the funding code: 03EN2020. The authors would like to thank the project-executing agency PTJ and the BMWK.

## References

1. [https://energy.ec.europa.eu/topics/energy-efficiency/energy-efficiency-targets-directive-and-rules/energy-efficiency-targets\\_en](https://energy.ec.europa.eu/topics/energy-efficiency/energy-efficiency-targets-directive-and-rules/energy-efficiency-targets_en). Accessed 01 July 2022
2. DIN EN ISO 50001: Energy management systems – Requirements with guidance for use (ISO 50001:2018), Beuth Verlag GmbH, 10772 Berlin
3. Kolley, R.: Technologies and production equipment for temperature-controlled sheet metal forming. In: Proceeding of 13. Dresdner Werkzeugmaschinen-Fachseminar, Dresden (2008)

4. Klocke, F.: *Fertigungsverfahren 5, Gießen und Pulvermetallurgie*, 5th edn. Springer, Heidelberg (2018)
5. Paetzold, J.: Messung elektrische Energie — Grundlagen und Erfahrungen. In: Neugebauer, R., et al. (eds.) *Methoden der energetischen Bilanzierung und Bewertung in der Produktionstechnik*, Chemnitz, pp. 35–53 (2011)
6. Rüdiger, D., Dobers, K.: Electricity measurements at logistics locations to determine energy drivers and savings potentials *Magdeburger Logistiktage*, vol. 18 (2013)
7. Paschotta, R.: Spitzenleistung. *RP-Energie-Lexikon-Spitzenleistung*. <https://www.energie-lexikon.info/spitzenleistung.html>. Accessed 01 May 2022
8. Graßl, M.A.: *Assessment of energy flexibility in production*. Diss. Technische Universität München (2015)

**Open Access** This chapter is licensed under the terms of the Creative Commons Attribution 4.0 International License (<http://creativecommons.org/licenses/by/4.0/>), which permits use, sharing, adaptation, distribution and reproduction in any medium or format, as long as you give appropriate credit to the original author(s) and the source, provide a link to the Creative Commons license and indicate if changes were made.

The images or other third party material in this chapter are included in the chapter's Creative Commons license, unless indicated otherwise in a credit line to the material. If material is not included in the chapter's Creative Commons license and your intended use is not permitted by statutory regulation or exceeds the permitted use, you will need to obtain permission directly from the copyright holder.





# Approach for Design of Low Carbon Footprint Paint Shops in the Automotive Industry

Jonas Wendt<sup>1</sup> , Astrid Weyand<sup>1</sup> , Boris Barmbold<sup>2</sup>, and Matthias Weigold<sup>1</sup> 

<sup>1</sup> Institute of Production Management, Technology and Machine Tools (PTW), Technical University of Darmstadt, Otto-Berndt-Straße 2, 64287 Darmstadt, Germany  
j.wendt@ptw.tu-darmstadt.de

<sup>2</sup> Paintnology GmbH, Christian-Wirth-Straße 18, 36043 Fulda, Germany

**Abstract.** To mitigate the ongoing progress of climate change, the European Commission announced in the European Green Deal to reduce greenhouse gas emissions by 55% until 2030 compared to the reference year 1990 and to achieve climate neutrality by 2050 [1]. In this context, the industry in particular faces environmental challenges due to its high energy demand. To achieve the objective of becoming climate-neutral, increasing the energy and resource efficiency in the industry is crucial, because a large proportion of the greenhouse gases released are emitted during the provision of energy. In the automotive industry, paint shops are among the most energy-intensive processes and have great potentials for efficiency measures. These potentials can be identified with the assistance of energy or CO<sub>2</sub> balancing methods. This publication presents a tool to analyse the energy efficiency potentials of automotive paint shops. The approach offers the possibility to parameterize different painting processes and their sub-processes. After defining the process requirements, a thermodynamic and process engineering simulation of the individual process steps enables the identification of potentials for energy and resource savings and CO<sub>2</sub> reduction in existing or planned painting processes. In a validation on a real reference scenario, the simulated CO<sub>2</sub> emissions of a paint shop were reduced by up to 24% .

**Keywords:** CO<sub>2</sub> accounting · Efficiency measures · Paint shop · simulation model

## 1 Introduction

Increasing prosperity, rising economic output and a growing world population result in a disproportionate consumption of resources and the emission of climate-damaging greenhouse gases such as carbon dioxide (CO<sub>2</sub>) into the atmosphere. Since a large proportion of the emissions released are linked to energy supply, energy efficiency measures should be implemented in particular in those sectors that account for the largest shares of total final energy consumption [2]. One of these sectors is the industry, which was responsible for 28.5% of final energy consumption in Germany in 2020 [3]. Automotive manufacturing is one of the most important and resource-intensive industrial segments. Since up to 73% of the total energy consumption of automobile factories can be attributed to

© The Author(s) 2023

H. Kohl et al. (Eds.): GCSM 2022, LNME, pp. 490–498, 2023.

[https://doi.org/10.1007/978-3-031-28839-5\\_55](https://doi.org/10.1007/978-3-031-28839-5_55)

painting processes, considerable energy and emission saving potentials are expected in this area, which is why the painting process is the focus of this paper [4]. For this purpose, an approach to design low carbon footprint paint shops was developed and applied in a use case. The approach is based on a Matlab Simulink tool which can simulatively analyze existing or planned systems according to a predefined scheme and calculate the released CO<sub>2</sub> emissions according to Scopes 1, 2 and partly 3 of the Greenhouse Gas Protocol (GHGP) [5].

In the following, the scopes and the general procedure of a CO<sub>2</sub> balancing including the determination of relevant CO<sub>2</sub> emission factors will be discussed. Following the concept structure of this approach, relevant efficiency measures for painting processes will be presented and validated with the help of the tool based on a real use case. After a discussion of the results, the knowledge gained will be concluded and an outlook on further developments will be given.

## 2 Background

### 2.1 Carbon Footprint Calculation

With the DIN EN ISO 14060 series, the German Institute for Standardization has created a standardized procedure for the preparation and evaluation of carbon footprints for organizations and projects. These standard series is based on the Greenhouse Gas Protocol, which pursues the goal of creating internationally recognized and uniform standards for carbon footprint calculation. The GHGP divides carbon emissions into three scopes. The first one being direct emissions resulting from the process itself, scope 2 being the indirect emissions related to energy supply and scope 3 including all other indirect emissions related to the product such as emissions in the usage phase of a product. For a carbon footprint according to the GHGP standard, all emissions of scope 1 and 2 must be included, scope 3 is optional [5]. To calculate a carbon footprint, CO<sub>2</sub> emission factors from specific databases such as ecoinvent [6] can be used for the consumed energy and materials.

### 2.2 Painting Processes

To make the following approach more comprehensible, the painting process steps in the automotive industry will first be briefly explained. The standard painting process is divided in process steps for corrosion protection and in processes for colour application. It starts with the pre-treatment as a dipping process to remove impurities from the car body. Afterwards, the so-called E-Coat is applied in a dipping process with high voltage. To protect the underbody, polyvinyl chloride (PVC) is coated in the following process steps. After PVC, the colour is applied in the three topcoat processes filler, basecoat and clearcoat in a spray-painting application. As a last process step, wax is inserted into the hollow spaces of the body. After waxing, the body is fully coated and can be transferred to assembly [7]. Figure 1 shows the different coating and drying processes in the standard painting process for car bodies. Process air is required in every process step, so the surrounding atmosphere in the paint shop has to be considered as well in the following approach.

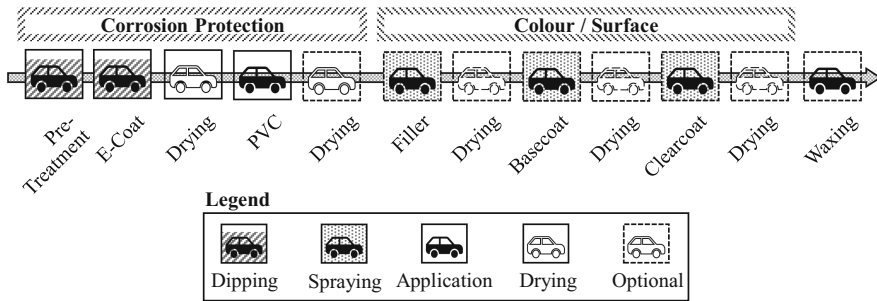


Fig. 1. Standard painting process in automotive series painting following [8].

### 3 Simulation and Improvement Approach

#### 3.1 Simulation Model

To determine the carbon footprint of the painting process and assess the effectiveness of different efficiency measures, a simulation model is built in the program Matlab Simulink [9]. For the simulation, the model has to be adjustable regarding different parameters. First of all, the different process steps need to be selectable individually, as not all process steps might be installed in every paint shop. Accordingly, the process parameters need to be configurable, like the characteristics of the painted part or the CO<sub>2</sub> emission factors to comply with local differences. Furthermore, the surrounding conditions of the paint shop need to be adjustable as well. These mainly include the climatic conditions of the ambient air for air distribution processes.

To estimate carbon footprint in each of the painting process steps as accurate as possible, the various material and energy flows within a paint shop are considered according to the principles of the GHGP. Figure 2 shows the exemplary energy and material inputs and outputs in paint shops. Energy flows in paint shops mainly consist of natural gas, electricity and cooling power and are simulated based on thermodynamical principles and respective process requirements. In addition, the main operating materials like paint, solvent, waste, fresh water or wastewater and compressed air are calculated based on process requirements like layer thickness of the desired paint layer and setpoint temperatures [10]. The paint consumption is calculated with the workpiece surface, the required layer thickness and the solid content of the paint, which remains after drying. Combined with the process-related overspray, this results in a total consumption of the paint. This overspray is collected in a paint separation system. Depending on the efficiency of the application system and the amount of paint, higher material consumption occurs in the filter system of the paint separator. This shows the mutual influence of the different processes. The necessary curing temperature as well as the weight and material of the workpiece can then be used to calculate the energy required for drying.

The calculated energy and material flows are linked to CO<sub>2</sub> emissions using CO<sub>2</sub> emission factors, in this case provided by the ecoinvent database version 3.8 [6]. Not all materials are yet available in the current version of ecoinvent, especially different paint mixtures. Thus, the CO<sub>2</sub> emission factors for these materials were estimated based on

their components and their respective weight proportion. To reduce the energy and material consumption and hence the carbon footprint, different energy efficiency measures are implemented in the simulation model. These measures include integrated processes, which will lead to a different process configuration. One example of an integrated process is the filler-free application that allows to combine the functional requirements of the filler into the basecoat layer and thus the filler process can be omitted completely. However, this results in a higher layer thickness and different paint material in the basecoat-process, which is considered automatically in the model for the carbon footprint calculation. In addition to more efficient process configurations, different process materials, which require less energy for their error-free application, or process equipment with higher efficiencies like paint separation systems can be simulated. Besides using different paint materials or process equipment, which leads to a change in the painting process, energy efficiency measures can also include more efficient process equipment like electrical motors or heat recovery systems to prevent heat loss into the atmosphere. These last measures have the advantage of reducing energy consumption without changing die painting process.

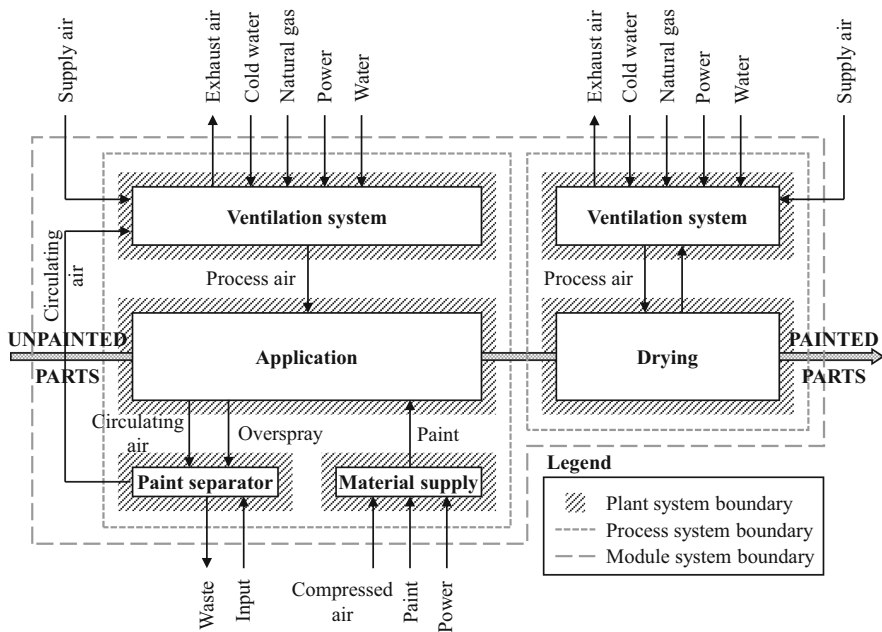


Fig. 2. Inputs and outputs of a paint shop regarding different system boundaries following [11].

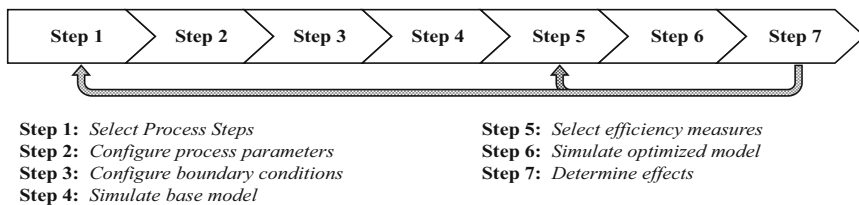
### 3.2 Approach to Identify Improvement Measures

In the first step of the application approach, shown in Fig. 3, the process steps are selected, since not all processes mentioned in Sect. 2.2 are installed in every paint shop. After the selection of the process steps, different process parameters must be defined to meet the



requirements of the manufacturer (step 2). Examples for process parameters are desired layer thickness and paint characteristics like solid content, water content and content of volatile organic compounds. Besides the process parameters, boundary conditions must be set (step 3). These include for example production conditions like throughput and production times. In addition, climatic conditions like ambient temperature and humidity for air distribution processes must be provided [10]. With process and product parameters and boundary conditions defined, the base simulation can be performed (step 4).

After this first simulation, multiple efficiency measures can be selected via pre-set variables. After the selection of the desired measures (step 5), the improved model can be simulated (step 6) to determine the effects of the efficiency measures in comparison to the base model (step 7). The results can be used afterwards to generate a CO<sub>2</sub> reduction plan or to use the energy and CO<sub>2</sub> data in feasibility studies. If needed, there can be multiple iterations with different efficiency measures to determine the best solution for the specific painting process. Furthermore, the approach can be started again if measures are implemented and parameters of the base model change as a result.



**Fig. 3.** Approach for the simulation model and determination of improvement measures.

## 4 Use Case

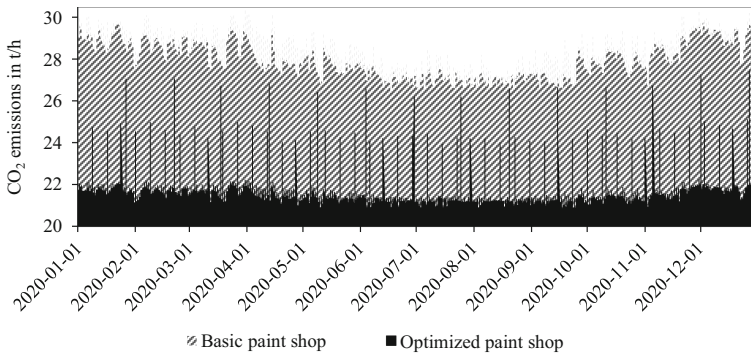
### 4.1 Application of the Approach

In the following, the model is configured to meet the requirements of the German automotive industry. Therefore, all process steps to coat a car body are simulated and improved regarding energy consumption and CO<sub>2</sub> emissions. As all processes steps described above are required in the standard automotive painting processes, they are all included within the model (step 1). The use case was developed with normed values for the process parameters (step 2) regarding paint application and drying. Product parameters were used from an existing body paint shop in Germany with a body weight of 380 kg plus an additional 250 kg for the conveyor skid, both made from steel and a maximum throughput of 55 bodies per hour. The surface area was set to 90 m<sup>2</sup> for dipping processes, 15 m<sup>2</sup> for PVC and 25 m<sup>2</sup> for topcoat processes. As many German car manufacturers are based in the south of Germany, the city of Augsburg was chosen for the climatic conditions of the use case with hourly climate data for the entire year of 2020 [12]. With process and product parameters and boundary conditions (step 3) defined, the base simulation was done (step 4). By applying different efficiency measures (step 5) and choosing the best

alternative for each measure, an optimized paint shop is simulated (step 6). The effect on CO<sub>2</sub> emissions is determined (step 7) and presented in the following chapter.

## 4.2 Results and Discussion

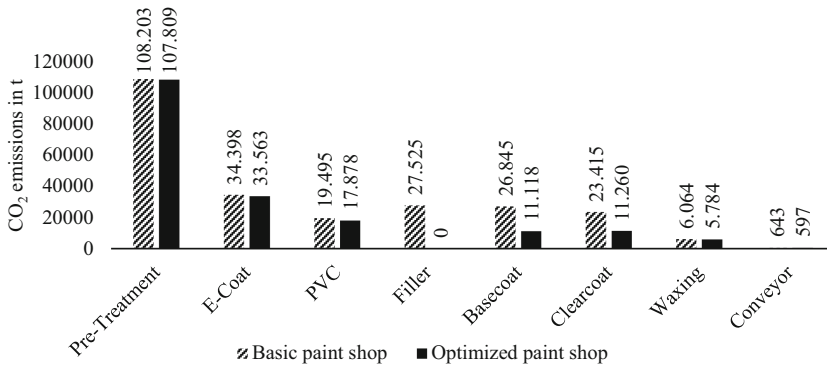
The base simulation, done with the defined parameters mentioned above, generates a consumption of 183 kWh of electrical energy per car body, 145 kWh of natural gas, 91 kWh of other energies, and 502 L of fresh water, respectively wastewater. The results comply with data provided in literature [8]. The annual carbon footprint of the basic paint shop is calculated to be 246,591 tons of CO<sub>2</sub>-equivalents with the assumptions made. In addition to the base simulation, each efficiency measure is simulated individually to identify the optimized paint shop. It should be noted that some measures are affecting each other, hence the combination of different efficiency measures results in a lower CO<sub>2</sub> reduction than the sum of each individual measure. Figure 4 shows the hourly carbon footprint of the basic paint shop and the optimized paint shop. The optimized paint shop with an average of 21.46 tons of CO<sub>2</sub>-equivalents per hour has a significantly lower carbon footprint than the basic paint shop with approximately 28.15 tons of CO<sub>2</sub>-equivalents per hour. In contrast to the base simulation, the optimized paint shop shows periodic outliers. They result from the dry paint separation of the spray booths, since the cardboard filters used in the booths have to be completely replaced and disposed at periodic intervals. With the exception of the outlier, the optimized paint shop is subject to lower seasonal fluctuations than the basic paint shop. This can be attributed in particular to the optimization of the ventilation technology using heat recovery systems and the increased tolerance window for the supply air. Therefore, the optimized paint shop is less susceptible to fluctuations in outside temperatures.



**Fig. 4.** Simulated hourly carbon footprint of basic paint shop and the optimized paint shop.

Figure 5 shows the CO<sub>2</sub> emissions per process for the basic paint shop and the optimized paint shop. It can be seen that the emission reductions are highest in the topcoat processes filler, basecoat and clearcoat. In total, the emissions of these processes are reduced by 71.2% compared to the basic paint shop. Furthermore, it is notable that pre-treatment, the process with the highest carbon footprint, can only be slightly optimized

by the measures presented. This can be attributed to the high emissions related to the wastewater produced. Since the amount of rinsing water and chemicals is calculated based on an existing reference plant and this process was not changed as part of the optimization, the water requirement of the plant has not changed either. For the optimized paint shop, this results in a carbon footprint of tons of CO<sub>2</sub> equivalents for one year. This corresponds to a reduction in CO<sub>2</sub> emissions of 23.8% compared with the basic paint shop.



**Fig. 5.** Simulated CO<sub>2</sub> emissions of processes per year for the basic paint shop and the optimized paint shop.

## 5 Conclusion and Outlook

With the help of the defined approach and the developed tool, the carbon footprint of various paint shops can be calculated. On the one hand, this allows new paint shops to be designed more efficient and sustainable in regard to required energy and resources. On the other hand, efficiency improvement measures for existing systems can be evaluated and implemented in a targeted manner. In addition to the reduction of carbon emissions, economic advantages can also be achieved in many cases through the short amortization periods of new, more efficient system components. The developed tool is designed to simulate a wide range of paint shops. Even though the steps of the presented approach are clearly defined, an analysis should only be performed by experts, as the accuracy of the simulation strongly correlates with the quality of the input data and the selected CO<sub>2</sub> emission factors. Based on the presented use case, the functionality of the tool was validated, and different efficiency improvement measures could be compared in regard to their carbon emission saving potentials. The program is currently being used and further developed by the Paintnology engineering office to apply it to more use cases. Further research is needed in particular to determine CO<sub>2</sub> emission factors for paint shop-specific resources such as paints and solvents. Following the results of the presented application scenario, the water and wastewater cycles of the pre-treatment of industrial paint shops should be examined more closely in order to develop CO<sub>2</sub> reduction possibilities, since the largest impact was identified regarding this resource.

**Acknowledgements.** This research is funded in the DiNaPro-project by the German Federal Ministry of Education and Research (BMBF) and implemented by the Project Management Agency Karlsruhe (PTKA). The authors are responsible for the content of this publication. Furthermore, we would like to thank Paintnology GmbH for their cooperation and provision of the data sets.

## References

1. European Union: Regulation (EU) 2021/1119 of the European parliament and of the council of 30 June 2021 (2021)
2. Hesselbach, J., Herrmann, C., Detzer, R., Martin, L., Thiede, S., Lüdemann, B.: Energy efficiency through optimized coordination of production and technical building services. In: Conference Proceedings LCE2008 - 15th CIRP International Conference on Life Cycle Engineering, pp. 624–628 (2008)
3. Umweltbundesamt: Energieverbrauch nach Energieträgern und Sektoren (2022). <https://www.umweltbundesamt.de/daten/energie/energieverbrauch-nach-energetraegern-sektoren#allgemeine-entwicklung-und-einflussfaktoren>. Accessed 8 May 2022
4. Zahler, C., Iglauer, O.: Solar process heat for sustainable automobile manufacturing. Energy Procedia **30**, 775–782 (2012)
5. Smith, B.: The greenhouse gas protocol: a corporate accounting and reporting standard. Rev. ed. ed. World Resources Institute; World Business Council for Sustainable Development, Washington, DC, Conches-Geneva, 112 p. (2004)
6. ecoinvent: About ecoinvent (2022). <https://ecoinvent.org/the-ecoinvent-association/>. Accessed 13 Dec 2021
7. Giampieri, A., Ling-Chin, J., Ma, Z., Smallbone, A., Roskilly, A.P.: A review of the current automotive manufacturing practice from an energy perspective. Appl. Energy **261**, 1–29 (2020)
8. Verein Deutscher Ingenieure: Emissionsminderung Anlagen zur Serienlackierung von Automobilkarosserien, 08th ed. 144 p (2013)
9. MathWorks: MathWorks: Makers of MATLAB and Simulink (2022). <https://www.mathworks.com/>. Accessed 8 May 2022
10. Verband Deutscher Maschinen- und Anlagenbau e.V.: Prognose des Energieverbrauchs von Lackieranlagen, 2010th ed. 87.100 (2010)
11. Feng, L., Mears, L.: Energy consumption modeling and analyses in automotive manufacturing plant. J. Manuf. Sci. Eng. **138**(10) (2016)
12. Deutscher Wetterdienst: Climate Data Center Germany (2022). [https://www.dwd.de/DE/klima/umwelt/cdc/cdc\\_node.html](https://www.dwd.de/DE/klima/umwelt/cdc/cdc_node.html). Accessed 4 January 2022

**Open Access** This chapter is licensed under the terms of the Creative Commons Attribution 4.0 International License (<http://creativecommons.org/licenses/by/4.0/>), which permits use, sharing, adaptation, distribution and reproduction in any medium or format, as long as you give appropriate credit to the original author(s) and the source, provide a link to the Creative Commons license and indicate if changes were made.

The images or other third party material in this chapter are included in the chapter's Creative Commons license, unless indicated otherwise in a credit line to the material. If material is not included in the chapter's Creative Commons license and your intended use is not permitted by statutory regulation or exceeds the permitted use, you will need to obtain permission directly from the copyright holder.





# A Practical Approach to Realize a Closed Loop Energy Demand Optimization of Milling Machine Tools in Series Production

Alperen Can<sup>1</sup>(✉), Hendrik Schulz<sup>1</sup>, Ali El-Rahhal<sup>1</sup>, Gregor Thiele<sup>2</sup>, and Jörg Krüger<sup>2</sup>

<sup>1</sup> Daimlerstraße 143, Mercedes-Benz AG, 12277 Berlin, Germany  
alperen.can@mercedes-benz.com

<sup>2</sup> Fraunhofer Institute for Production Systems and Design Technology IPK, Pascal-Straße 8-9,  
10587 Berlin, Germany

**Abstract.** Energy efficiency is becoming increasingly important for industry. Many approaches for energy efficiency improvements lead to the purchase of new hardware, which could neglect the sustainability. Therefore, optimizing the energy demand of existing machine tools (MT) is a promising approach. Nowadays energy demand optimization of MT in series production is mainly done manually by the operators, based on implicit knowledge gained by experience. This involves manual checks to ensure that production targets like product quality or cycle time are met. With data analytics it is possible to check these production targets autonomously, which allows optimizing production systems data driven. This paper presents the approach and evaluation of a closed loop energy demand optimization of auxiliary units for milling MT during series production. The approach includes, inter alia, a concept for machine connectivity using edge devices and a concept for validating production targets.

**Keywords:** Energy Efficiency · Machine Tool · Optimization · Series Production · Energy Demand

## 1 Introduction

In view of increasing ecological awareness, rising production costs and strict political demands for the sustainable use of resources and the reduction of greenhouse gas emissions, companies are increasingly moving towards environmentally friendly production. According to a study by the German Federal Association of Energy and Water Industries, approximately 45% of total electricity consumption in Germany was used by the industry sector in 2020 [1]. Of this, metal production and processing, which includes the automotive industry, account for a significant share of about 23% [2]. In average more than two thirds is used by MT [3]. Therefore, MT are a interesting use case for energy optimization.

There are various optimization approaches, most of which relate to specific operating states of MT [4]. The productive operating state, with the longest runtime in series production and highest power consumption, has the greatest savings potential [5]. However,

manipulations in productive operating state can affect the functionality of the machine. In series production, this can have an impact on the entire production chain. Monitoring of important key performance indicators (KPIs) to ensure the production goals must take place to safeguard the process. The steps to be taken for a successful implementation of such an optimization will be discussed and tested in this paper. The following question is to be answered: What steps are necessary for successful closed-loop optimization in series production? This leads to two further questions. How is the connection to the machine organized? How can the KPIs be determined and tracked?

Section 2 explains the technical environment of the optimization, as well as important production and control fundamentals. Section 3 gives an overview of already implemented energy optimization approaches on MT. The applicability to the considered technical context will be discussed. Section 4 presents a possible approach to realize energy optimization on MT in series production. All necessary steps are analyzed in detail. Section 5 contains the implementation and evaluation of the approach on a grinding machine in serial production. Section 6 finally summarizes the results and discusses the generality of the approach.

## 2 Technical Context

In the following, the technical environment and MT as an object of optimization are examined in more detail. Production and control fundamentals are explained and requirements for the optimization procedure are identified.

### 2.1 Series Production

With increased quantities, workpieces are often processed in series production, whereby a workpiece usually to go through different manufacturing processes until the desired product is produced. An industrial production facility with multiple manufacturing resources is called a manufacturing system (MS) [6]. The performance of a MS or individual machines is measured in terms of overall equipment effectiveness (OEE), which is a measure of value creation consisting of availability, performance and quality factors [7].

The availability factor relates the actual productive time of a system to the operating time, in which planned downtimes such as tool setups or unplanned downtimes such as malfunctions can also occur. The performance factor describes the utilized duration of the system's production time and identifies short downtimes. The quality factor describes the ratio of defect-free parts that meet quality requirements to the total number of parts produced. The quality can be controlled directly in the machine (inline) or on a separate measuring machine (offline). The multiplication of the three factors gives the OEE in percent and is calculated as follows. [8]

$$\text{OEE} = \text{availability} \cdot \text{performance} \cdot \text{quality} \quad (1)$$

According to Bertagnolli in [9], average OEE values in automotive industry are around 60–80%. The OEE is also an indicator of the effective use of energy in MS and must not be negatively influenced by improvement measures.

## 2.2 Machine Tools

MT are an essential part of a MS. In the structure of a MT, a distinction is made between main and auxiliary assemblies. The main assembly includes the components that carry out the actual manufacturing process, also called the main process. Accompanying the main process there are several auxiliary processes, which support the manufacturing process by auxiliary units and provide for example cooling and lubrication. They do not directly influence the process. In addition, auxiliary units account for around 60% of the MT total energy consumption [10]. This makes auxiliary units a promising object for energy demand optimization.

## 2.3 Control System of Machine Tools

The linking and interaction of the individual components of a modern MT is realized by the Programmable Logic Controller (PLC). Inter alia, the PLC has tasks such as starting and stopping the movements of spindles and axes, switching auxiliary media on and off, and changing target values of forces, torques and rotational speeds. Depending on the requirements for precision or complexity, the PLC can be also used to address a numerical control system, named Computerized Numerical Control (CNC). [11].

Depending on the subsystems control of a MT and the material flow, the machine is set to different operating states by the control system. The productive operating state usually has the highest power consumption and longest runtime and thus the greatest potential for energy savings [12]. Therefore, only this state will be examined.

## 3 State of the Art

Some approaches to energy optimization of MT already exist in a similar technical context. However, the extent to which these provide a suitable approach for implementing energy efficiency measures will be considered below.

In Denkena et al. [13] the authors present a strategy to reduce the energy consumption of a MT. Therefore, the high-pressure coolant flow is adapted to the optimal quantity of flow while taking the influence on the tool wear into account. With additionally attached sensors, the volume flow was recorded, and new operating points were transferred from the NC code to the frequency inverter by a PROFIBUS connection. By this implementation up to 37% energy could be saved in the optimal case. Nonetheless the authors state, that the necessary software functions are not commonly available and tests outside of secured laboratory conditions were not conducted.

In [14], the energy consumption of a CNC-controlled MT was optimized in productive operation. For this purpose, a virtual MT was simulated, which estimated the energy consumption and feed rate for each line of the NC program. A generic optimizer adjusted spindle speed, feed rate and coolant pump pressure in the form of an improved NC program. Experiments on the CNC machine were able to show an energy saving of 13% after optimization. However, successful application outside laboratory conditions on MT that are more complex remains questionable.



Outside of secure laboratory conditions, the manipulation of a MT in a production system can affect the entire production chain. In [15], an approach for the safe process optimization of MT in series production was presented. The core of the work was the determination of production critical KPIs to validate the process capability of the machine. From this, a decision tree for the optimization of MT in series production was derived, which provides recommendations for action in the event of a violation of the KPIs and checks the validity of the optimization. Based on these results, an approach for the implementation of a closed loop optimization will be presented in the following.

## 4 Approach

The realization of a closed optimization loop requires not only the necessary connectivity to the control system of the MT, but also safety measures to adequately safeguard the manufacturing process and reach production goals during series operation. To avoid a negative impact on the OEE, it is recommended to control the machine with the shortest possible downtime and constant component quality. The following assumptions and requirements should be met for this purpose.

### 4.1 PLC

The control of the MT represents a production critical system and ensures the machine functions. The PLC must not be overloaded by the optimization cycle. However, continuous setpoint specifications and computationally intensive data analyses could provoke this, making a different solution necessary.

External industrial computers, mainly called industrial edge devices, can reduce load on the control system. The edge device communicates with the control system via Profinet and can collect and specify data without significant loads on the PLC. Furthermore, it is possible to calculate new setpoints based on the collected data using computationally intensive algorithms.

### 4.2 Connectivity

The key figures of the OEE presented in Sect. 2 must be checked continuously in order to guarantee a high overall effectiveness of the process. For a closed loop optimization, it is necessary to collect this data either from the machine or from external sources such as a Manufacturing Execution System (MES). Therefore edge device must be connected to external systems outside of the MT.

### 4.3 Setpoint Specification

Optimized parameters should be able to be activated without downtime. The data transfer takes place via the Profinet connection of the PLC. The PLC should continuously check whether new parameters are being transferred. As soon as these are available, their values have to be checked for validity regarding syntax and semantics to avoid malfunctions. If a value is invalid, it is to be rejected.

#### 4.4 Optimization Procedure

MT in series operation repeatedly perform a defined production process within one cycle. The process result can therefore be validated after each cycle. It is not advisable to change the setpoints dynamically during the production process, since the cause-effect chain would not be traceable. Instead, the target value should be specified statically, so that a new target value is defined before the start of a production cycle.

#### 4.5 Closed Loop Energy Demand Optimization

In the first step, the edge device must be integrated into the existing system of the plant. The necessary hardware installations, such as the edge device and peripherals, must be connected. A connection to the control system is established via Profinet. Access to the MES is established via the machine's LAN switch. The PLC must be extended by function blocks that enable communication to the edge device. The overall approach structure, with the systems connections is shown in Fig. 1.

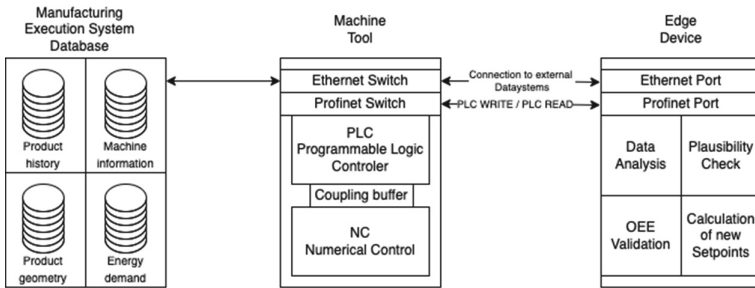


Fig. 1. Overall approach structure with peripheral connections

Secondly, the data acquisition is to be realized. Important data points for safeguarding the OEE, as well as the parameters for specifying the target values, must be localized in the PLC and integrated in the edge device. Applications for controlling the setpoints and for recording the data points may have to be implemented in the edge device. All optimization data must be collected and put into a uniform format for comparability. Finally, the data must be merged and matched on a time and cycle basis.

In the last step, the optimization itself is facilitated. Target values must be checked for syntax and semantics before each specification and the OEE must be continuously monitored to detect defective production. The optimizer and its application should be designed according to the use case. For instance, the selection can be based on the possible number of trials or the system complexity.

## 5 Implementation

The approach is to be implemented on a grinding machine in a camshaft production, which processes the surfaces of the camshafts. The optimization will be realized during series operation.

## 5.1 Hardware Installation

The MT has an inline quality inspection. A measuring device for tracking the total electrical power consumption is available and transmits the current power consumption to the MES every second. The Industrial Edge from Siemens is used for data collection and setpoint specification. The edge device is connected to the machine and MES via the Profinet and LAN connections as described in Sect. 4.6.

## 5.2 Data Acquisition

The setpoints to be specified are taken from the respective function blocks of the PLC. For the approach, a high-pressure cooling pump is varied about pressure in order to reduce the total energy consumption. In the given solution, the configuration of the edge device is done via a web interface, which offers the possibility to define the necessary data points from the PLC and predefined setpoints in tabular form. Applications for writing and reading the data points were also developed via the web interface. The characteristics required for tracking the OEE and the energy savings are as follows:

- The **cycle time** of the production cycle specifies the speed of the production process and serves as the start and end point for predefined setpoints.
- The **operating status** of the MT provides information about whether the machine is in productive operation.
- For the evaluation of the **component geometry**, the discrete values of the probes are collected. The tolerance limits are available in the corresponding function block, so that this information will also be collected.
- The **energy measurement** is carried out via the counter reading of the multifunction meter and is to be collected in the controller in the associated function module.

In principle, it is possible to collect further process data that could serve as indicators for the changes in the system. However, with this approach, attention is paid only to the unique values that provide information about the OEE.

For comparability of the data, it is converted into a uniform CSV format and sorted by time and cycle. Data generated during the manufacturing, must be aggregated to a uniform frequency. The part geometry is recorded after each production cycle and thus assigned to the correct production cycle via the part ID of the workpiece.

## 5.3 Optimization

Here, an optimization problem was investigated under three constraints named quality (N1), cycle time (N2) and technical availability (N3). These can be represented by lower and upper tolerance limits  $x_{\min}^i, x_{\max}^i$  as follows  $N_i = [x_{\min}^i, x_{\max}^i]$ ,  $i = 1, \dots, 3$ .

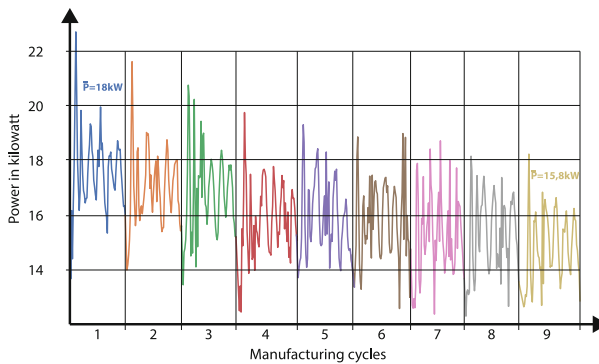
To solve this problem, the task is to find a local minimum of the function without violating the constraints. The function to be optimized  $E : \Omega \subset \mathbb{R}^d \rightarrow \mathbb{R}$  describes the energy consumption, where  $d$  corresponds to the number of inputs and  $\Omega$  defines the set of admissible input parameters, which do not violate the constraints ( $N_i$ ).

In order to safeguard the process, the factors of the OEE should be considered individually, thus ensuring that all components of the OEE are complied with. A slight reduction in OEE is already an indication of process deterioration. To determine the OEE coefficient, the values of the constraints are considered binary rather than discrete numerical values. As soon as one of the target parameters leaves one of the  $N_i$  process reliability is endangered and the input parameter used is discarded.

For example, the experiments are performed using the gradient descent with continuous validation of the target variables. Using this gradient method, one progresses from an arbitrary starting point in the direction of the steepest descent, until a stationary point is reached. The method now iteratively computes from a predefined value  $x_0$  a sequence of points  $(x_k)$ ,  $k \in \mathbb{N}$  according to the following iteration rule  $x_{k+1} = x_k + \alpha_k * d_k$ ,  $k = 0, 1, \dots$ , where the descent direction is given by  $d_k = -\nabla E(x_k)$  and  $\alpha_k \in \mathbb{R}$  determines the step size. The step size is a variable quantity that can be chosen smaller with increasing computing power or time to increase the accuracy of the optimization.

## 6 Results

The approach of a closed-loop optimization on a MT in series operation could be successfully carried out. Using an edge device did not overload the PLC. With the existing software for the configuration of the data to be collected and setpoints to be described, the process could be monitored continuously and the setpoints could be given to the machine without any problems.



**Fig. 2.** Power consumption of the MT during Closed loop optimization experiments

The experiments led to energy savings without changing the value of the OEE. As shown in Fig. 2, iterative gradient descent was used to localize energetically improved operating points. Compared to the starting point, an energy saving of about 12% was achieved. An approximately linear relationship was found in the range of values considered.

## 7 Conclusion

The paper presented a practical approach to realize a closed loop energy demand optimization of milling machine tools in series production. Data evaluation and optimization runs on an edge device that is physically connected to the machine's PLC. The optimization KPIs can be tracked using data from the PLC and the MES. A constant OEE is understood as a benchmark for successful optimization.

The feasibility of the approach was shown for a grinding machine, where energy savings of about 12% could be achieved. With the ability to read data directly from the PLC via the edge device and tracking OEE as a general benchmark, the applicability of the approach to other milling machine tools is conceivable.

Future work should examine whether this approach can be automated. For this purpose, however, it should be investigated to what extent the cause-effect chain can be traced with regard to medium- and long-term consequences. The tests did not show any abnormalities, but this could be the case with regard to tool durability, for example.

## References

1. bdew: Stromverbrauch in Deutschland nach Verbrauchergruppen 2020 (2021). <https://www.bdew.de/presse/pressemappen/faq-energieeffizienz/>. Accessed 01 May 2022
2. Liebl, C.B.: Systematische Energiedatenerfassung in der Produktion, Technische Universität München, München (2019)
3. Redecker, M.E.: Kenngrößen der Energieeffizienz in der spanenden Fertigung. TU Graz, Graz (2016)
4. Nitesh Sihag, K.S.: A systematic literature review on machine tool energy consumption. *J. Clean. Prod.* **275**, 123125 (2020)
5. Yoon, H.S., Kim, E.S., Kim, M.S., Lee, J.Y., Lee, G.B., Ahn, S.H.: Towards greener machine tools – A review on energy saving strategies and technologies. *Renew. Sustain. Energy Rev.* **48**, 870–891 (2015)
6. Christian Brecher, M.W.: Werkzeugmaschinen Fertigungssysteme 1. Springer, Heidelberg (2018). <https://doi.org/10.1007/978-3-662-46565-3>
7. Erlach, K.: Wertstromdesign: Der Weg zur schlanken Fabrik. Springer, Heidelberg (2010). <https://doi.org/10.1007/978-3-540-89867-2>
8. Focke, M., Steinbeck, J.: Steigerung der Anlagenproduktivität durch OEE-Management: Definitionen, Vorgehen und Methoden – von manuell bis Industrie 4.0. Springer Fachmedien, Wiesbaden (2018). <https://doi.org/10.1007/978-3-658-21456-2>
9. Bertagnolli, F.: Lean Management. Springer Fachmedien, Wiesbaden (2020)
10. Can, A., Thiele, G., Krüger, J., Fisch, J., Klemm, C.: A practical approach to reduce energy consumption in a serial production environment by shutting down subsystems of a machine tool. *Procedia Manuf.* **33**, 343–350 (2019)
11. Weck, M.: Werkzeugmaschinen 3. Springer Vieweg, Heidelberg (2006). <https://doi.org/10.1007/978-3-540-32506-2>
12. Ma, F., Zhang, H., Gong, Q., Hon, K.K.B.: A novel energy efficiency grade evaluation approach for machining systems based on inherent energy efficiency. *IJPR* **59**, 6022–6033 (2021)
13. Energy efficient machine tools. *CIRP Ann. Manuf. Technol.* **69**, 646–667 (2020)
14. Lee, W., Kim, S.H., Park, J., Min, B.K.: Simulation-based machining condition optimization for machine tool energy consumption reduction. *J. Clean. Prod.* **150**, 352–360 (2017)

15. Can, A., Fisch, J., Stephan, P., Thiele, G., Krüger, J.: Automated continuous learn and improvement process of energy efficiency in manufacturing. In: IECON, vol. 46, pp. 757–762 (2020)

**Open Access** This chapter is licensed under the terms of the Creative Commons Attribution 4.0 International License (<http://creativecommons.org/licenses/by/4.0/>), which permits use, sharing, adaptation, distribution and reproduction in any medium or format, as long as you give appropriate credit to the original author(s) and the source, provide a link to the Creative Commons license and indicate if changes were made.

The images or other third party material in this chapter are included in the chapter's Creative Commons license, unless indicated otherwise in a credit line to the material. If material is not included in the chapter's Creative Commons license and your intended use is not permitted by statutory regulation or exceeds the permitted use, you will need to obtain permission directly from the copyright holder.





# Load Profile Optimization Using Electricity Wholesale Market Price Data for Discrete Manufacturing

Clemens Schwaiger<sup>(✉)</sup>, Thomas Trautner, and Friedrich Bleicher

TU Wien, Institute of Production Engineering and Photonic Technologies,  
Getreidemarkt 9, Objekt 1, BA - OG 8, Vienna 1060, Austria  
schwaiger@ift.at  
<http://www.ift.at/>

**Abstract.** Several strategies for reducing energy costs can be derived from the energy procurement cost function for Austrian end users of electrical energy. Based on short-term energy procurement on the *day-ahead* trading floor an optimization problem for cost-optimal scheduling of the load curve of a single plant has been formulated. A preliminary study for an annealing furnace is presented and it is found that the approach can lead to significant savings during periods of volatile prices. Furthermore, the strategy is applicable to any production process that provides sufficient flexibility, and therefore, if the trade-off between peak energy costs is included, can be applied to entire production systems.

**Keywords:** energy flexibility · demand side management · demand response · energy price volatility · day-ahead · energy-cost-optimization

## 1 Introduction

For end-use customers of electrical energy, price volatility is expected to persist beyond a phase of fluctuating and generally high prices since the end of 2021. This will be caused by different factors, notably one of them being the rising share of variable renewable energy (VRE) on the supply side [3]. The associated uncertainty of energy-costs will and already is affecting more and more industrial subsectors that are dependant on energy to perform value-adding. The energy-intensive sector (EIS) is already working on mitigating energy costs and lowering the environmental impact of the inherent processes for quite some time, driven by a high share of energy-related costs of unit costs as well as policy measures.

Industry is generally dependent on the availability of energy at reasonable prices, but when energy prices were sufficiently low, end-use customers outside the EIS, whose demand for energy is on a lower level, were not significantly affected by the cost. These intermediate energy consumers have not yet intensively addressed the issue of cost containment in energy procurement and must now respond. This set of industrial enterprises can be denominated as the energy-dependant sector (EDS) and encircles a rather specific set of production

processes [3]. The difference in how energy is consumed by companies within the EIS and the EDS is significant thus, strategies specifically tailored to the production systems within the EDS, that largely coincide with discrete mechanical manufacturing (DMM) must be found.

## 2 State of the Art

In order to incentivize sustainability measures in the industrial sector one has to look at energy-related costs. Considering DMM the most significant energy carrier in Austria is electric energy [2,3]. The total procurement costs  $EPC$  for electric energy can be described with a procurement cost function, including all taxes, tariffs, grid and energy costs [3]:

$$EPC = C_f + c_p P_p + W(c_{W,f} + \bar{c}_W) \quad (1)$$

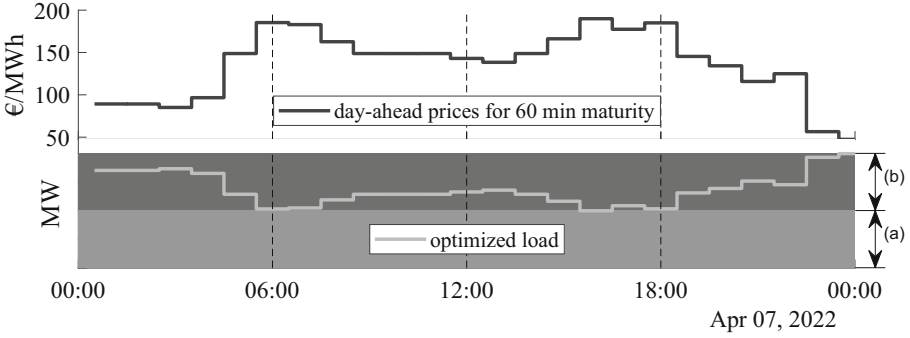
Therein  $C_f$  are fixed costs and  $c_p$  is the cost factor for peak power demand  $P_p$ , i.e. the maximum power uptake within the billing period. The three variables in Eq. 1 are the peak power demand  $P_p$ , the amount of electric energy consumed  $W$  and the wholesale market price, represented as the mean costs per billing period  $\bar{c}_W$ . Because of high utilization and a low share of downtime or operational readiness of plants, lowering  $W$  through energy efficiency is the way to go in the EIS. In the EDS however energy efficiency, i.e. the lowering of energy input whilst maintaining the same level of product output, is not that easily scalable [3]. Lowering the overall energy uptake is of the essence within the EDS too, but unclaimed flexibilities on the demand side considering production systems of DMM are more easily accessible. Rather than lowering the energy uptake per se these may be utilized in order to react to the growing share of VRE on the supply side and thus, to mitigate costs [3,4]. This is in opposition to most processes within the EIS, where continuous processes cannot be interrupted. In contrast to discrete production, there is also little or no leeway for postponing or prioritizing process cycles regarding batch processes.

Schwaiger et al. deduced two basic ways for flexibilizing the demand side with regards to energy costs, either by *pro-* or *reactive flexibilization* [3]. This is based on the two market floors end-use customers will trade on in order to procure electric energy short-time. We decidedly neglected long-term trading because of the increasing short-term volatility of energy prices through VRE and the as of yet unknown long-term developments caused by the transformation of the energy system and focused on *proactive flexibilization*.

### 2.1 Proactive Flexibilization

Equations defining the incurrence of costs by directly or indirectly trading electric energy on the short-term wholesale trading floors, be it near real time (*intra-day*), or on the day preceding delivery (*day-ahead*) have been stated by Schwaiger et al. [3]. The according costs for *day-ahead* trading are stated in Eq. 2. In the following the denotations (left superscript)  $d$  for the day of delivery,  $d - 1$  for





**Fig. 1.** A qualitative example for *proactive flexibilization*; (a) baseload; (b) potential bandwidth for flexibilization [1]

the day before delivery and  $\bar{d}$  for a reference workday are used as well as the indices (right subscript)  $i = 1, \dots, 24$  for hourly and  $j = 1, \dots, 4$  for quarter hourly products.

$${}^{d-1}C = \sum_{i=1}^{24} {}^{\bar{d}}W_i {}^{d-1}c_i \tag{2}$$

Minimizing  ${}^{d-1}C$  is the basic goal for *proactive flexibilization*, i.e. optimizing the load curve for the next day by planning accordingly. Basically the load curve should resemble the vertical reflection of the graph representing hourly price. More so, optimally the load curve has maxima where prices are lowest and vice versa. A qualitative example for *proactive flexibilization* is given in Fig. 1 where a load curve with a given base load (a) and a flexible bandwidth (b) is fitted accordingly. In this simple example the discrete prices have been mirrored to the abscissa, normalized on the interval  $[0,1]$  and multiplied with the power flexibility potential in order to produce the optimized load curve.

### 3 Energy-Cost Optimization for DMM through Proactive Flexibilization

Given the aforementioned situation on the supply side from the viewpoint of an end-use consumer corresponding to DMM the following problem arises: The usually rather volatile load profile has to be matched with different blocks of energy procured on the wholesale market at least a day in advance.

Schwaiger et al. introduced proactive flexibilization as a price-driven strategy to procure electric energy on the day-ahead trading floor [3]. It is formulated as an optimization problem for the convolution of the two functions  ${}^{d-1}c(t)$  for the day-ahead prices and  $P_{plant}(t)$  for the power uptake of a single plant:

$$({}^{d-1}c * P_{plant})(t) = \int_{\tau_1}^{\tau_2} {}^{d-1}c(\tau)P_{plant}(t - \tau) d\tau \tag{3}$$

The result of Eq. 3 is the time-dependant cost function for a single cycle of the plant where  ${}^{d-1}c(t)$  and  $P_{plant}(t)$  are functions continuous in time. The power uptake of the plant may in fact be represented by a time-continuous function, e.g. when it's load curve can be defined analytically depending on the process parameters, or empirically by learning from past cycles. In an early stage of implementing *proactive flexibilization*  $P_{plant}$  will rather be represented by the measurement of the plants power uptake during a typical production cycle, thus being discrete in time. *Day-ahead* prices will be set for products with a maturity of 60 min and thus also are discrete in time, i.e.  $c_i = c_1, c_2, c_3, \dots, c_{24}$ . Either way the problem stated in Eq. 3 has to be solved numerically. If the plant's power uptake is continuous in time it has to be discretised to  $P_i = P_1, P_2, P_3, \dots, P_{24}$ . The numerical convolution is defined as

$$(c_i * P_{plant,i})(n) = \mathbf{P}_{plant} \vec{c} \quad (4)$$

where  $\vec{c}$  is the vector of hourly day-ahead prices and  $\mathbf{P}_{plant}$  is the convolution matrix.

$$\vec{c} = \begin{bmatrix} c_1 \\ c_2 \\ \vdots \\ c_{24} \end{bmatrix}, \mathbf{P}_{plant} = \begin{bmatrix} \vec{P}_{plant} & 0 & 0 & \dots & 0 \\ 0 & \vec{P}_{plant} & 0 & \dots & 0 \\ \vdots & 0 & \vec{P}_{plant} & \dots & 0 \\ \vdots & \vdots & \vdots & \ddots & \vdots \\ 0 & 0 & 0 & \dots & \vec{P}_{plant} \end{bmatrix} \quad (5)$$

The minimum of the convolution will yield the most energy-cost effective point in time to start the process cycle:

$$\min(\mathbf{P}\vec{p}) \rightarrow t_{start} \quad (6)$$

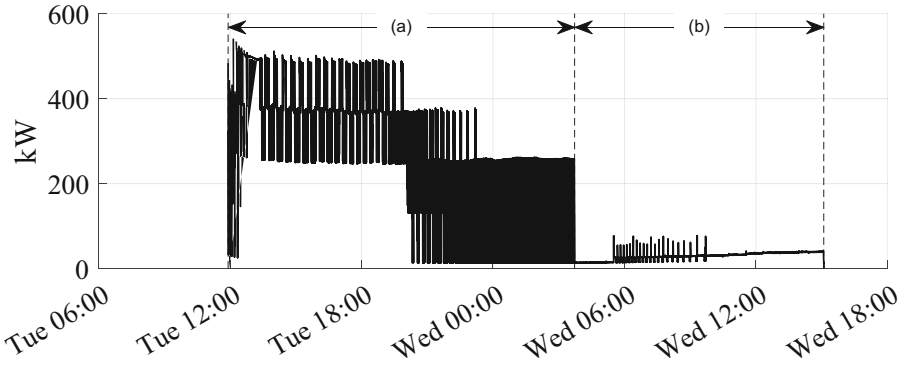
## 4 Prestudy of Proactive Flexibilization

A practical implementation of proactive flexibilization has been evaluated for the annealing of machine parts. The corresponding plant is an air convection oven equipped with electrical heating. Thus, the plants power consumption mainly stems from the operation of the heating resistors with a small portion of the overall uptake caused by the electric motors driving fans. The technical specifications of the plant are stated in Table 1.

Cycle duration and power uptake over time are mainly influenced by the mass of steel to be treated, the dimension of the parts and the holding temperature. The plant will always be loaded up to the maximum and processes other than annealing with a far lower energy demand may be conducted, but are the exception. Thus, a representative annealing process cycle, i.e. the plants power uptake over time, has been monitored, see Fig. 2. This process-specific load curve was averaged to 60 min intervals and used as input  $\vec{P}_{plant}$  for the optimization problem stated in Eq. 6. For proactive flexibilization the goal is to best match

**Table 1.** Technical data of the annealing convection oven

		Unit
Nominal power of the heating resistors	450	kW
Maximum load of steel parts	30	t
Annealing target temperature	600	°C

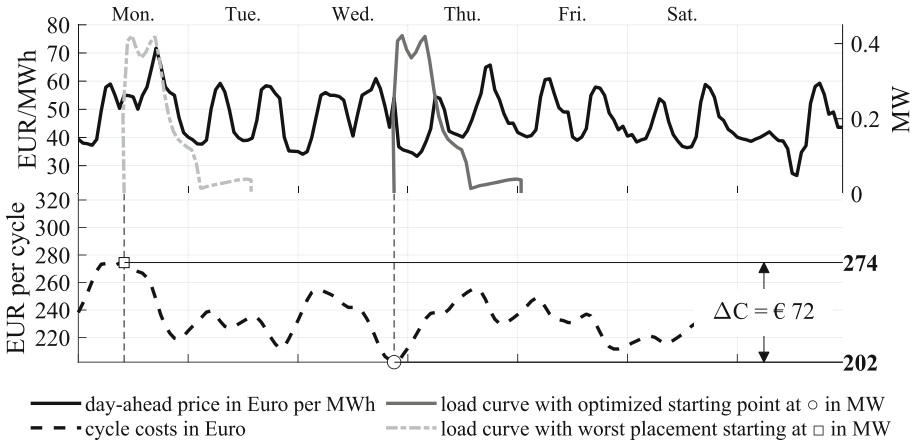


**Fig. 2.** Uptake of electrical power; annealing oven; (a) phase with active heating resistors (heating up, maintaining temperature and controlled cooling down); (b) cooldown phase where only fans are active

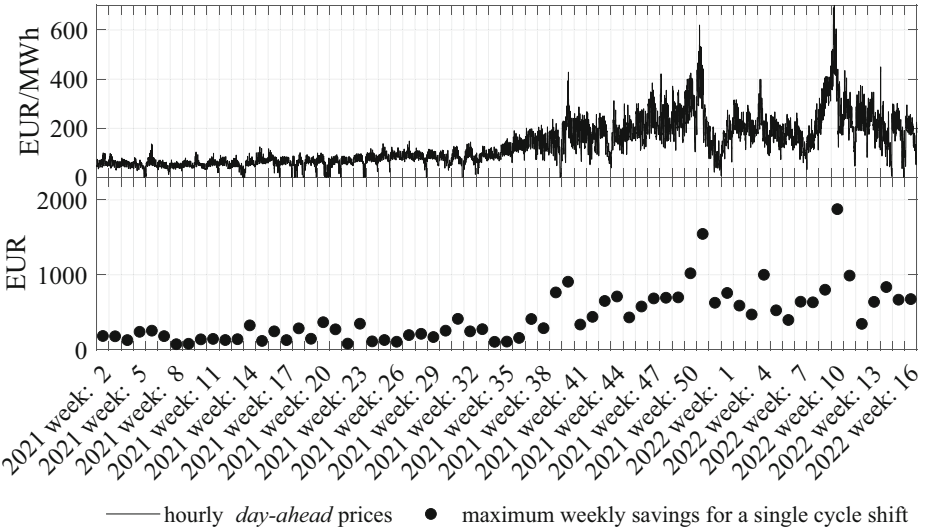
load to the *day-ahead* prices, where only maturities of 60 min can be traded at the moment. Therefore the characteristics of the load curve during the hour are not of interest. Only the cumulative electric energy consumed during the period is of importance.

The other input of Eq. 6, i.e. the hourly prices on the *day-ahead* trading floor  $\vec{c}$ , has been derived from historic wholesale price data from EPEX Spot [1]. Week long time frames ranging from the first quarter of 2021 to the second quarter of 2022 have been selected for evaluation. The length of the time frame stems from the fact that the annealing process' duration is well over 24 h. Therefore it can not be scheduled on a daily basis but weekly. Thus, the energy-cost optimal starting point within a week for the given reference cycle has been calculated.

Figure 3 shows an exemplary result for calendar week 8 in 2021. In the upper graph the hourly prices on the *day-ahead* trading floor are shown on the primary axis, as well as the energy-cost-optimized annealing cycle starting at  $t_{start}$  and its counterpart resulting in the cost maximum indicated by the power uptake over time on the secondary axis. As the cycle duration is around 27 h it must be started on Saturday at the latest. The lower graph represents the overall costs for electrical energy per annealing cycle, i.e. the solution of the numerical convolution as stated in Eq. 4. By being able to freely shift the cycle in time over a whole week a maximum difference in costs  $\Delta C$  of €72 could be achieved



**Fig. 3.** Weekly *proactive flexibilization* of an annealing cycle for calendar week 8 in 2021



**Fig. 4.** Maximum weekly potential savings by shifting the annealing cycle in time [1]

between the best and worst timed cycles. This result has been generated within a time frame with stable wholesale energy market prices, represented by a typical daily pattern of high prices during mid day and low prices during the night, as well as differences over the span of the week where prices on weekends are generally moderate.

Results of weekly energy-cost optimization of the annealing cycle are stated in Fig. 4 and have been generated from calendar week 2 in 2021 to calendar week 16 in 2022. Looking at the top graph the rise of energy prices to the end

of 2021 can be seen. Furthermore, the aforementioned familiar pattern in price fluctuation over the week has been more and more disrupted by the end of 2021, resulting in the uncertainty of even short-term predictions. A typical outcome of energy-cost-optimization for the ca. 27 h long annealing cycle in times of stable and thus, predictable market prices, is that it will be shifted to the weekend. On extending the time frame for optimization to two weeks, the phases of high power demand (i.e. the phase of heating up) thus, would be shifted to the night from Saturday to Sunday.

In calendar week 10 of 2022 the energy-cost-optimal cycle costs differ as much as €1.877 from the worst placed cycle, representing the maximum theoretical savings over the whole period analyzed. In conclusion the shifting in time of the presented annealing cycle only results in significant savings when the usual price pattern during a week does not hold up and especially when the spread of high and low prices during a week is high.

## 5 Conclusion and Outlook

Two strategies for energy-cost optimization have been deduced from the energy procurement cost function, being *pro-* and *reactive flexibilization*. It has been emphasized on the latter, which focuses on load scheduling typically at least a day ahead and has been formulated as a numerical convolution of hourly prices on the *day-ahead* trading floor and the time-discrete load curve of a single plant. The minimum of the function resulting from the convolution gives the cost-optimal starting point of the process cycle in time.

A prestudy of *proactive flexibilization* has been conducted, using historical *day-ahead* market data and the time series of a representative process cycle of an air convection annealing oven. It could be shown that in weeks where prices are following a usual pattern, even if they are relatively high, potential savings are moderate. In times of high volatility and a high price level, savings for this particular application range from several hundred to several thousand Euros. The typical outcome is to shift the cycle to the weekend because of the 27 h duration and long time slots of lower prices then. The prestudy was performed ignoring further limitations caused by production planning that may not allow for the energy-cost-optimized process cycle placement and thus, practicable savings may be much lower. The duration of the process cycles, the times in between needed for loading and unloading and the two shift rotation restrict flexibilization greatly. In practice operation of the given plant also needs to adhere to a given schedule because of a high workload.

The following conclusions can be derived, which lead to steps for expanding the approach of *proactive flexibilization* and increase practicability:

- As a basic assessment unclaimed flexibility of production processes within a factory has to be assessed to choose the right production processes for *flexibilization*. An indicator for quantifying the potential regarding flexibility is lacking.

- Given high enough energy costs it may even be practical to increase flexibility by changing given procedures, but costs due to the increased effort in production planning must be weighed against the savings in energy costs.
- Limits given by production planning have to be introduced to *proactive flexibilization*, i.e. the time frame available for energy-cost optimization has to be adjusted accordingly.
- Given additional restrictions  $\min(\mathbf{P}\bar{p})$  will have to be solved repeatedly, whilst after each iteration the time frame has to be trimmed.
- Since *proactive flexibilization* is plant or process specific, multiple computations must be performed in parallel to cover an entire facility and the procedure must be extended to calculate the expected trade-off due to peak power costs.
- The numerical convolution is easily scalable which is beneficial for practical implementation, especially given the necessity of multiple parallel calculations with potentially many iterations each, when applied to a production system or even a factory.

Assuming that current developments within the (electrical) energy system will lead to persistent volatility and given the fact that investment costs for implementing *proactive flexibilization* are low, it can provide enough of a monetary incentive in order to be applicable in practice. In addition, the application is not process-specific in terms of production technology and can therefore be used on a larger scale, provided sufficient flexibility is offered. We assume that a high potential of unclaimed flexibilities exists in DMM in general, as well as a high potential for actively expanding flexibilities for the purpose of energy-cost optimization.

**Acknowledgements.** This work has been partially supported and funded by the Austrian Research Promotion Agency (FFG) via the “Austrian Competence Center for Digital Production” (CDP) under the contract number 881843.

## References

1. Epex Spot. Market data (2022)
2. Eurostat. Energy balance flow for Austria 2019 (2022)
3. Schwaiger, C., Trautner, T., Bleicher, F.: Energy-cost-optimized strategies for discrete mechanical manufacturing. *Procedia CIRP* (2022)
4. Serale, G., Gnoli, L., Giraud, E., Fabrizio, E.: A supervisory control strategy for improving energy efficiency of artificial lighting systems in greenhouses. *Energies* **14**(1), 202 (2021)

**Open Access** This chapter is licensed under the terms of the Creative Commons Attribution 4.0 International License (<http://creativecommons.org/licenses/by/4.0/>), which permits use, sharing, adaptation, distribution and reproduction in any medium or format, as long as you give appropriate credit to the original author(s) and the source, provide a link to the Creative Commons license and indicate if changes were made.

The images or other third party material in this chapter are included in the chapter's Creative Commons license, unless indicated otherwise in a credit line to the material. If material is not included in the chapter's Creative Commons license and your intended use is not permitted by statutory regulation or exceeds the permitted use, you will need to obtain permission directly from the copyright holder.



# **Industry 4.0 and Digitalization**





# Conceptual Framework of a Digital Twin Fostering Sustainable Manufacturing in a Brownfield Approach of Small Volume Production for SMEs

Sandra Krommes<sup>(✉)</sup> and Florian Tomaschko

Technical University of Applied Science Rosenheim, 83024 Rosenheim, Germany  
wi.sem@fh-rosenheim.de

**Abstract.** SMEs are increasingly forced to shift to more sustainable manufacturing. Industry 4.0 can support the transformation and foster innovation. But, SMEs need solutions with a low barrier to entry in terms of investment, IT knowledge and capacities. A framework based on value and material flow analysis, low investments and user-oriented IT skills is proposed. As an example, it is implemented in the furniture industry and shows a digital twin in terms of monitoring the energy and material flows. In addition, a product-specific allocation of energy consumption, energy peak shaving and other applications are possible.

**Keywords:** Industry 4.0 technology · Green transformation of manufacturing

## 1 Introduction

For decades, growing economic, environmental and social challenges have reinforced the need for a “green transformation” in production. The increasing demand for resources by industry leads to environmental problems. As small and medium-sized enterprises (SMEs) are responsible for 60–70% of industrial pollution in Europe, they need solutions to address sustainability [1, 2]. Combined with resource scarcity which entails supply risks and price volatilities, this poses major challenges, but also offers opportunities in terms of reduced environmental impact and lower supply risks. All companies, including SMEs, must develop their business models into sustainable ones.

Sustainable manufacturing (SM) can be seen a part of sustainable development (SD): Based on the UN Brundtland Commission, which has defined sustainability as “meeting the needs of the present without compromising the ability of future generations to meet their own needs”, the approach is applied to the concept of SM [3]. In addition, the UN agreed on the 17 SD Goals (SDGs) in 2015. Three of them relate to SM and cover different aspects, namely SDG 7, 9 and 12. While SDG 7 and 12 consider energy intensity or material consumption, that can be achieved with SM approaches and technologies, SDG 9 emphasizes building resilient infrastructure, promoting inclusive and sustainable industrialization and fostering innovation. Target 9.4 explicitly calls for upgrading infrastructure and retrofitting industries to make them sustainable, with increased resource-use

efficiency and greater adoption of clean and environmentally sound technologies and industrial processes [4].

## **2 Sustainable Manufacturing in the Context of Industry 4.0**

### **2.1 Sustainable Manufacturing and Industry 4.0**

There has been no uniform definition of SM among scientists for years, and even today different approaches are associated with SM [5, 6]. A general definition is given by Chen and Zhang, who describe SM as “the science and technology of manufacturing based on the idea of SD” [7]. Loglisci et al. go further, seeing SM as a key component of SD [8]. Following Moldavska and Welo, most definitions agree that SM is the creation of a product or service taking into account the environmental, economic and social dimensions. However, the literature distinguishes between whether it is a strategy or concept on the one hand, or a paradigm or system on the other. Further, while it can be assumed that the entire life cycle is considered, only a few deal with the end-of-life in the context of SM. Almost all definitions reflect the goal of reducing impacts or improving the relevant factors of production [5].

For this paper, SM is defined as “the integration of systems and processes capable to produce high-quality products and services by utilizing less and more sustainable resources such as energy and material, being safer for societies, employees, consumers, stakeholders and being able to mitigate social and environmental impacts throughout its whole life cycle” [9]. Bonvoisin et al. present four overlapping and complementary layers that considers the objects addressed and disciplines concerned to achieve SM [10]: According to these layers, the framework looks at the first layer, manufacturing technologies, which addresses the two factors of value creation process and equipment. The aim is to increase energy, resource and economic efficiency and reduce environmental impact through a digital twin by applying I4.0 technologies.

### **2.2 Industry 4.0 Enabling Technologies for Sustainable Manufacturing**

I4.0 describes the transformation of the industry through Internet of Things (IoT), data and services. The term integrates different perspectives, sectors, industries, corporate functions, technologies and subject areas [11]. Its technologies have a huge scope of application and cover a broad spectrum. Suleiman et al. 2022 list 24 concepts that also include concepts beyond production: With regard to sustainability, the concepts of circular economy, remanufacturing, sustainability and Recycling 4.0 are mentioned. Accordingly, the sustainability concept of I4.0 “enables and supports sustainability by deploying digital technologies and business models with a focus on energy efficiency, pollution control, and value chain optimization” [12].

Ching et al. identify eight I4.0 technologies that are relevant for the economic, ecological and social dimension of SM [13]: Artificial Intelligence, Blockchain, Big Data Analytics, Cyber-Physical (Production) Systems (CP(P)S), Industrial Internet of Things (IIoT), Digital Twins (DT), mixed reality and robotics. Others mention fog and cloud

computing, actuators and sensors, 3 D print (additive manufacturing), cognitive computing, simulation and modelling related to sustainable or energy efficient manufacturing, to name but a few technologies [14–17].

For the purpose of this framework, technologies such as CPPS, IIoT, DT and sensors as well as methods such as data analytics and machine learning are relevant (Table 1). The technologies collect, transfer, store and process real time data via the infrastructure of the network (IIoT), while data analytics and machine learning methods analyse them for decision-making. These technologies and methods drive the digital transformation of production systems, which offer a variety of opportunities to use real-time data to increase sustainability in manufacturing [17–20]. Based on this, metrics are often used for SM assessment that prepare the real-time data for further use, e.g. key performance indicators, process maps, forecasts. Several metrics are available taking into account the three dimensions of sustainability [21–24].

**Table 1.** Terms, definitions and application of I4.0 technologies and methods

Term	Definitions	Application in the context of the conceptual framework	
Technologies	CPPS	A cyber-physical (production) system (CP(P)S) is comprising a set of interacting physical and digital components, which may be centralised or distributed, that provides a combination of sensing, control, computation and networking functions, to influence outcomes in the real world through physical processes [25]. In a production context, it is referred to as a CPPS.	Based on the IIoT, machines, IoT connectors and sensors on the shopfloor level, ERP and MES systems, data bank and analytic software form a CPPS.
	DT	A digital twin (DT) is a digital representation of a physical unit (real device, object, machine, service, or intangible asset) or product-service system that comprises its selected characteristics, properties, conditions, and behaviors by means of models, information, and data within a single or even across multiple life cycle phases [26].	Real-time data from machines and sensors, enriched with ERP and MES data, create a digital twin from the processing data, machine data, value and material flow data of the process chain.
	IIoT	The Internet of Things (IoT) form the infrastructure for the networking of cyber-physical systems and enables people and CPS to have controlling, coordinating and location-independent access to the integrated CPS [27]. The application of the IIoT in an industrial context is referred to as Industrial Internet of Things (IIoT) [18].	The IIoT enables the communication of the Industry 4.0 components and provides the network for digital data collection and the CPPS.
	Sensor	A sensor is a device that detects the input stimulus, which can be any quantity, property or condition from the physical environment, and responds to a measurable digital signal. For instance, the input stimulus can be pressure, force, flow, light, heat, motion, humidity or many other environmental phenomena. The output signal is usually an electrical form of a signal (voltage, current, capacitance, resistance, frequency, etc.), which is converted into a readable display or transmitted electronically over a network [28].	Sensors are collecting data (power, compressed air, waste, exhaust, etc.) and transmit them digitally via IIoT to a data bank or cloud.
Methods	Artificial Intelligence (Big) Data Analytics	A subtopic of artificial intelligence (AI) is machine learning, in which algorithms are used to recognise patterns and regularities. Solutions can then be developed based on the empirical data sets.	Machine learning is used to detect anomalies in manufacturing, e.g. processing characteristics.
	Data Analytics	Data analysis can be divided into the categories system infrastructure and analysis methods. While system infrastructure focuses on preparing the data for analysis, analysis methods focus on how to gain insights from the data. The latter are divided into descriptive, predictive and prescriptive analyses [29].	Data analysis methods are used to monitor efficiency or to predict power performance for demand side management or peak shaving.

Therefore, I4.0 technologies are recognised as a key facilitator in SM [6, 30]. Kumar et al. take a different perspective, noting that SMEs are under enormous pressure to produce more sustainable. Stakeholders ask SMEs to implement sustainability and request, for example, information on resource, material and energy consumption or their carbon footprint. The application of I4.0 may support SME in these efforts [31]. However, due to their economic footprint, SMEs are one of the most important pillars for the sustainable growth of national economies [30].

### 2.3 Industry 4.0 Challenges for SME and Small Volume Production

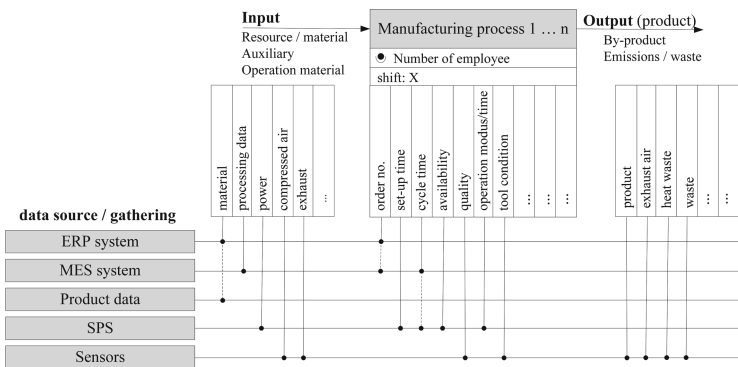
Large manufacturers are often taking a leading role in the adoption of technologies as they have greater opportunities to embrace and transform them, while many SMEs are reluctant to adopt [32]. The main barriers for adopting I4.0 are a lack of expertise and a short-term strategy mindset [33, 34]. In addition, limited IT skills, capacities and investment costs are a common concern [35]. SMEs’ production is often characterised by heterogeneous machines of different ages, from different manufacturers and with a variety of protocols and sometimes missing processing information (brownfield) [36]. Or it is a production that not infrequently also has a batch size of up to 1.

Studies tend to focus on global companies. Consequently, SMEs are often treated similarly in their transformation towards SM and I4.0, although they have different requirements. Thus, research is needed to support SMEs that help smaller players to continue or implement I4.0 innovations. Due to limited capacities, technologies need to prove their benefits quickly in order to be pursued further in SMEs. I4.0 applications for SMEs therefore require solutions that have low barriers to entry [35].

## 3 Framework for a Digital Twin for Sustainable Manufacturing

### 3.1 Method of Value and Material Flow Analysis in the Context of I4.0

Increasing sustainability in manufacturing is related to inputs and outputs, internal and external process parameters and characteristics, machining time, quality and the condition of machines and tools. Therefore, a combined value and material flow analysis was developed as a methodological basis in the context of I4.0 [37]. Depending on the aim of SM, the availability of (digital) data from different sources, ranging from ERP and MES systems to product data and machine and sensor data, is analysed and missing data must be collected with the help of I4.0 technologies (Fig. 1).



**Fig. 1.** Value and material flow analysis in the context of I4.0 for SM

Thus, I4.0 technologies offer a real-time, consistent and continuous collection of relevant data from the machines, sensors and operational information systems to implement a digital twin for the value and material flow of a process chain. In combination

with data analytic methods and user-related process knowledge, the data-based value and material flow model can be used for various issues of SM.

### 3.2 Framework for a Digital Twin in the Context of Sustainable Manufacturing

The framework links the methodology of value and material flow analysis with the architecture of I4.0 real-time based information, communication and data processing technologies. The stored data are then used to provide real-time data for operations profitability, energy and resource efficiency towards digital twins. The framework is developed for a brownfield approach that allows SMEs to retrofit their existing machines with I4.0 technologies regardless of heterogenous machine types, age, data format. Aim is to provide an I4.0 based solution for SM with a low entry threshold (Fig. 2).

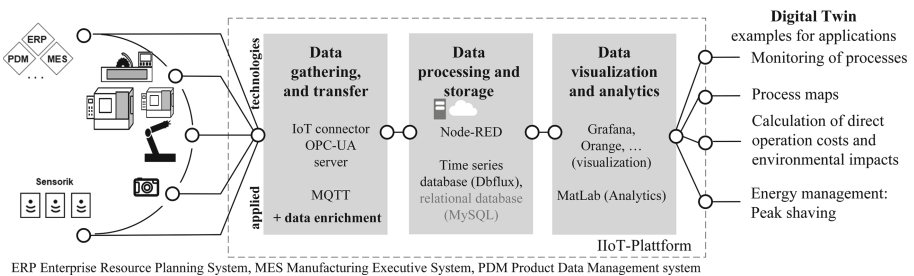


Fig. 2. Architecture of the conceptual framework for SM

Data from ERP, MES and PDM systems as well as machine data are collected with an OPC-UA server that converts them. While the machine data is real-time data from operations, the others are static data for process or product-specific analyses. Sensor data is collected by IoT connectors located at the machine site and transmitted using the messaging protocol MQTT (Message Queuing Telemetry Transport). In a next step, the data is processed with the object-based programming Node-RED and written to a database. Since the data is collected in small time steps, a time series database is recommended to process the flood of data appropriately in terms of time and storage capacity. The processed data serves as a digital backbone for visualization and analytics. Simple applications such as the monitoring of value and material flows as well as the utilization of machines are already possible with open source graphics programs. For data analytics, MatLab is recommended as a common tool for engineers. Descriptive analytics such as process maps for improved start-up of a process at the beginning of a shift to prescriptive analytics dealing with the energy peak shaving based on production planning and process data in order to reduce energy demand from the power grid.

### 3.3 Application of the Conceptual Framework for SM

The framework is applied in a small volume production in the furniture industry. It reflects typical processes from the panel sawing, edge banding and drilling and milling (Fig. 3). At shop floor level, the machines are equipped with IoT connectors, sensor

technology for power, compressed air, exhaust air and waste, with data being collected every 250 ms. In the periphery system, the compressor and exhaust air system are equipped with sensors (power). In addition, data is extracted from the CAD product configurator, ERP and MES systems. This data characterises the material, density and size of the material and the parts to be produced, machining data per process step, e.g. type of edge band, number of sides to be edged, number of drillings per part. The data collected by the IoT connectors is transmitted via the MQTT protocol and processed with Node-RED. The material and product data are provided via an OPC UA server. All data is written to a DBflux database; all data analytics are carried out with MatLab.

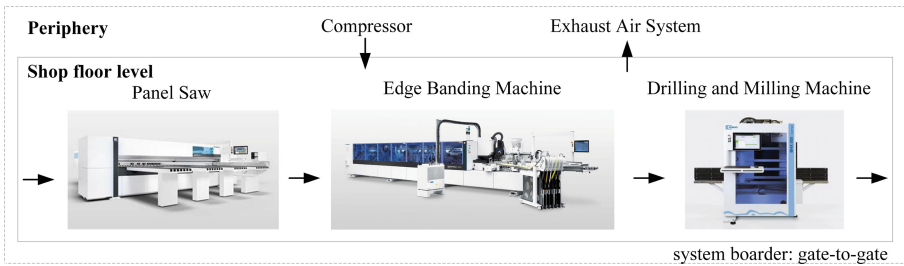


Fig. 3. Process chain in the furniture industry

The digital backbone of real-time data, enriched with product and process data, enables diverse applications in terms of SM. In the field, a real time monitoring of energy and material consumption for a small volume production with a parameterized process model was developed based on real-time data (Fig. 4). This allocates the consumption and power demand to specific components. Further applications develops a parameterized process (chain) model for forecasting energy and material consumption or machine occupancy, assessment of the total power demand to shave energy peaks, and direct offsetting of energy and processing costs at component and product level; or calculation of cumulative energy demand or CO<sub>2</sub> footprint of a product.

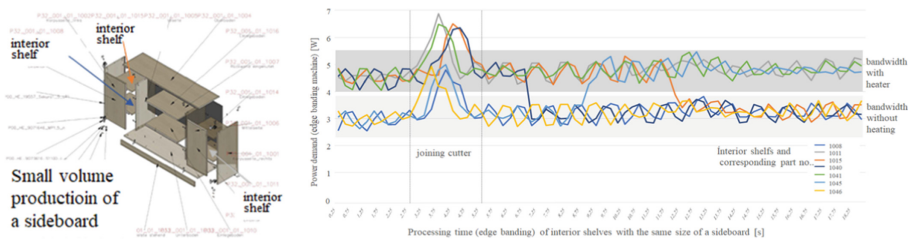


Fig. 4. Small volume production of a sideboard: Power demand monitoring by defined bandwidth with/without heater of a banding edge machine for glueing the edge

Depending on the impacts and potentials of the manufacturing processes, SMEs need to derive strategies on how I4.0 can support sustainability efforts.

## 4 Conclusions

Based on a combined value and material flow analysis, the conceptional framework presents an approach that can be applied to implement SM applications in the context of I4.0. The methodology of material flow analysis is mainly known among environmentally oriented economists and engineers, but qualifies as a suitable approach for SMEs by combining it with the well-known method of value flow analysis. To address the SME situation, the framework avoids proprietary solutions to create a digital twin. Furthermore, it focuses on a brownfield environment with machines from different manufacturers and different levels of digitalisation, as is often the case in SMEs. The I4.0 hardware and software have a low barrier to entry in terms of costs and required skills. SMEs can apply it to a single process and then gradually extend it to others. Successes in real-time process monitoring and process maps encourage SMEs to take further steps. Various application as direct cost calculation or accounting of environmental impacts of products in small batch production are possible. However, there is a need for further research into solutions for a horizontal process integration.

**Acknowledgement.** The paper presents results of the ReFer project, which was funded by the Bavarian State Ministry of Education and Cultural Affairs, Science and the Arts.

## References

1. Constantinou, C., et al.: SMEs and the environment in the EU, European Commission, DG Enterprise and Industry, Brussels (2010)
2. EaPGreen: Environmental Policy Toolkit for Green SMEs in the EU Eastern partnership countries, Brussels (2015)
3. World Commission on Environment and Development (WCED): Our Common Future, Report of the World Commission on Environment and Development, Oxford and N.Y. (1987)
4. UN: Sustainable Development: The 17 goals. <https://sdgs.un.org/goals>. Accessed 30 Apr 22
5. Moldavska, A., Welo, T.: The concept of sustainable manufacturing and its definitions: a content-analysis based literature review. *J. Clean. Prod.* **166**, 744–755 (2017)
6. Sartal, A., Bellas, R., Mejías, A.M., García-Collado, A.: The sustainable manufacturing concept, evolution and opportunities within Industry 4.0: a literature review. *Adv. Mech. Eng.* **12**(5), 1–17 (2020)
7. Chen, M., Zhang, F.: End-of-life vehicle recovery in China: consideration and innovation following the EU ELV directive. *JOM* **61**(3), 45–52 (2009). <https://doi.org/10.1007/s11837-009-0040-8>
8. Loglisci, G., Priarone, P.C., Settineri, L.: Cutting tool manufacturing: a sustainability perspective. In: Proceedings of the 11th GCSM, Berlin, pp. 252–257 (2013)
9. Malek, J., Desai, T.N.: Prioritization of sustainable manufacturing barriers using best worst method. *J. Clean. Prod.* **226**, 589–600 (2019)
10. Bonvoisin, J., Stark, R., Seliger, G.: Field of research in sustainable manufacturing. In: Stark, R., Seliger, G., Bonvoisin, J. (eds.) *Sustainable Manufacturing*. SPLCEM, pp. 3–20. Springer, Cham (2017). [https://doi.org/10.1007/978-3-319-48514-0\\_1](https://doi.org/10.1007/978-3-319-48514-0_1)
11. Kagermann, H., Anderl, R., Gausemeier, J., Schuh, G., Wahlster, W.: *Industrie 4.0 im globalen Kontext*, Berlin (2016)

12. Suleiman, Z., Shaikholla, S., Dikhanbayeva, D., Shehab, E., Turkyilmaz, A.: Industry 4.0: clustering of concepts and characteristics. *Cogent Eng.* **9**, 1 (2022)
13. Ching, N.T., Ghobakhloo, M., Iranmanesh, M., Maroufkhani, P., Asadi, S.: Industry 4.0 applications for sustainable manufacturing: a systematic literature review and a roadmap to sustainable development. *J. Clean. Prod.* **334**, 130133 (2022)
14. Bonilla, S.H., Silva, H.R., da Silva, M.T., Goncalves, R.F., Sacomanto, J.: Industry 4.0 and sustainability implications: a scenario-based analysis of the impacts and challenges. *Sustainability* **10**, 3740 (2018)
15. Jena, M.C., Mishra, S.K., Moharana, H.S.: Application of Industry 4.0 to enhance sustainable manufacturing. *Environ. Progr. Sustain. Energy* **39**, e13360 (2020)
16. Mohamed, N., Al-Jaroodi, J., Lazarova-Molnar, S.: Leveraging the capabilities of Industry 4.0 for improving energy efficiency in smart factories. *IEEE Access* **7**, 18008–18020 (2019)
17. Oláh, J., Aburumman, N., Popp, J., Khan, M.A., Haddad, H., Kitukutha, N.: Impact of Industry 4.0 on environmental sustainability. *Sustainability* **12**, 4674 (2020)
18. Beier, G., Ulrich, A., Niehoff, S., Reißig, M., Habich, M.: Industry 4.0: how it is defined from a sociotechnical perspective and how much sustainability it includes – a literature review. *J. Clean. Prod.* **259**, 120856 (2020)
19. Beltrami, M., Orzes, G., Sarkis, J., Sartor, M.: Industry 4.0 and sustainability: towards conceptualization and theory. *J. Clean. Prod.* **312**, 127733 (2021)
20. Stock, T., Seliger, G.: Opportunities of sustainable manufacturing in Industry 4.0. *Procedia CIRP* **40**, 536–541 (2011). Proceedings of the 13th GCSM, Berlin
21. OECD: Sustainable manufacturing toolkit – 7 steps to environmental excellence (2011)
22. Joung, C.B., Carrell, J., Sarkar, P., Feng, S.C.: Categorization of indicators for sustainable manufacturing. *Ecol. Ind.* **24**, 148–157 (2012)
23. Bhanot, N., Qaiser, F.H., Alkahtani, M., Rehman, A.U.: An integrated decision-making approach of cause-and-effect analysis for sustainable manufacturing indicators. *Sustainability* **12**(4), 1517 (2020)
24. Swarnakar, V., Singh, A.R., Jayaraman, R., Tiwari, A.K., Rathi, R., Cudney, E.: Prioritizing indicators for sustainability assessment in manufacturing process: an integrated approach. *Sustainability* **14**, 3264 (2022)
25. Boyes, H.: A security framework for cyber-physical systems, WMG CSC Working Paper, Coventry, University of Warwick (2017)
26. Stark, R., Damerau, T.: Digital Twin. In: Chatti, S., Tolio, T. (eds.) *CIRP Encyclopedia of Production Engineering*, pp. 1–8. Springer, Heidelberg (2019). [https://doi.org/10.1007/978-3-642-35950-7\\_16870-1](https://doi.org/10.1007/978-3-642-35950-7_16870-1)
27. Bischoff, J., Taphorn, C., Wolter, D., Braun, N., et al.: Erschließen der Potenziale der Anwendung von Industrie 4.0 im Mittelstand, Studie (2015)
28. Javaid, M., Haleem, A., Singh, R.P., Rab, S., Suman, R.: Significance of sensors for Industry 4.0: roles, capabilities, and applications. *Sens. Int.* **2**, 100110 (2021)
29. Duan, L., Xu, L.D.: Data analytics in Industry 4.0: a survey. *Inf. Syst. Front.* (2021) <https://doi.org/10.1007/s10796-021-10190-0>
30. Suciu, A.-D., Tudor, A.I.M., Chitu, I.B., Dovleac, L., Bratucu, G.: IoT Technologies as instruments for SMEs' innovation and sustainable growth. *Sustainability* **13**, 6357 (2021)
31. Kumar, R., Singh, R.K., Dwivedi, Y.K.: Application of Industry 4.0 technologies in SMEs for ethical and sustainable operations: analysis of challenges. *J. Clean. Prod.* **275**, 124063 (2020)
32. Rauch, E., Dallasega, P., Unterhofer, M.: Requirements and barriers for introducing smart manufacturing in small and medium-sized enterprises. *IEEE Eng. Manage. Rev.* **47**(3), 87–94 (2019)
33. Moefuf, A., Lamouri, S., Pellerin, R., Tamayo-Giraldo, S., Tobon-Valencia, E., Eburdy, R.: Identification of critical success factors, risks and opportunities of Industry 4.0 in SMEs. *Int. J. Prod. Res.* **58**, 1384–1400 (2020)



34. Rauch, E., Unterhofer, M., Roja, R.A., Gualtieri, L., Woschank, M., Matt, D.T.: A maturity level-based assessment tool to enhance the implementation of Industry 4.0 in small and medium-sized enterprises. *Sustainability* **12**, 3559 (2020)
35. Chavez, Z., Hauge, J.B., Bellgran, M.: Industry 4.0, transition or addition in SMEs? A systematic literature review on digitalization for deviation management. *Int. J. Adv. Manuf. Technol.* **119**, 57–76 (2022)
36. Ingaldi, M., Ulewicz, R.: Problems with the implementation of Industry 4.0 in enterprises from the SME sector. *Sustainability* **12**, 217 (2020)
37. Krommes, S., Tomaszko, F.: Chance für mehr Ressourceneffizienz. *Zeitschrift für wirtschaftlichen Fabrikbetrieb* **116**, 58–63 (2021)

**Open Access** This chapter is licensed under the terms of the Creative Commons Attribution 4.0 International License (<http://creativecommons.org/licenses/by/4.0/>), which permits use, sharing, adaptation, distribution and reproduction in any medium or format, as long as you give appropriate credit to the original author(s) and the source, provide a link to the Creative Commons license and indicate if changes were made.

The images or other third party material in this chapter are included in the chapter's Creative Commons license, unless indicated otherwise in a credit line to the material. If material is not included in the chapter's Creative Commons license and your intended use is not permitted by statutory regulation or exceeds the permitted use, you will need to obtain permission directly from the copyright holder.





# Pharma 4.0: Revealing Drivers of the Digital Transformation in the Pharma Sector

Michelle Grace Tetteh<sup>(✉)</sup> , Sandeep Jagtap , and Konstantinos Salonitis 

Sustainable Manufacturing Systems Centre, School of Aerospace, Transport and Manufacturing,  
Cranfield University, Cranfield MK43 0AL, UK  
michelle.tetteh@cranfield.ac.uk

**Abstract.** The primary goal of this paper was to uncover the drivers of digital transformation (DT) in the pharmaceutical industry. The Covid-19 pandemic and tightening regulatory standards in the global pharma industry necessitated pharma executives need to understand the most critical drivers of digitalizing the sector and charting a new path that improves production processes and streamlines these companies' overall supply chain. This research aims to identify the drivers for DT in the pharmaceutical industry. The Web of Science Core Collection and Scopus gathered relevant data for the research study. The research employs objective analysis to ensure that more reliable conclusions were drawn following the study. The study also proposed that external and internal factors, such as supply chain difficulties and data silos, impact DT adoption in the pharmaceutical sector.

**Keywords:** Digital transformation · Industry 4.0 · Pharma 4.0 · Pharmaceutical industry · Supply chain complexities

## 1 Introduction

This section clarifies the pharmaceutical sector during the pandemic and how it influences its activities. Pharmaceuticals were one of the most rapidly changing industries in 2020, with the adoption of new digital technologies becoming more common throughout the pandemic. Covid - 19 prompted a rise in the use of technology to halt the rapid spread and death of millions of people worldwide. These DTs ranged from big data analytics to aid in research and development (R&D) and clinical trials. Artificial Intelligence (AI) surveillance cameras and drone-borne cameras, among others, can not only collect real-time data on people's locations but also track and restrict their mobility inside a monitored/locked-down area [1].

The pharmaceutical business is anticipated to spend more than \$4.5 billion on DT by 2030 [2, 3]. Pharmaceutical companies believe that implementing digital processes will result in savings of 20% or more, including a 17% reduction in expenses associated with poor product quality and a 14% reduction in delivery reliability. Lee et al. [4] predicted that Pharma 4.0 might increase output by 200% compared to current capabilities. They further underlined that digital changes and automation have resulted in more than 65% overall deviation reductions and 60–90% testing time reductions.

At the very least, the Covid-19 outbreak heightened global awareness of the need to accelerate the implementation of cutting-edge DT procedures [5, 6]. As a result, scientists worldwide reacted quickly, emphasizing the critical role those digital technologies play in mitigating the effects of new challenges like Ebola and the Covid Pandemic and assisting manufacturing companies in scaling up and improving the entire process from product development to market sales [7]. As a result, companies have been motivated to further progress on their DT journeys [8].

In this context, this paper will review pertinent literature, reveal the key drivers to a digitalized pharmaceutical space, identify relevant gaps and challenges, and highlight the benefits of adopting digitalization and its impact on operations in the pharma sector.

## 2 Literature Review

This section defines and gives clarity on what DT is with examples. DT is defined by researchers as a cultural development or construction of a business model, redefining firm capabilities, processes, and linkages to fundamentally disrupt established (traditional) business practices [7]. Furthermore, Carcary et al. [9] state that effective digitalization needs to develop diverse skills, which would change depending on the business climate and the company's need to remain competitive. As a result, digital technology must be integrated into how businesses process and companies must effectively rethink and perhaps redesign their business models. Thoben et al. [10] described DT as “changes that digital technology causes or effects on all aspects of human existence”; however, this definition confounds the concept with its impact. Various DT definitions are accessible as scholars have sought to strengthen the DT concept by broadening the definition and terminology outside the sphere of usage [11]. It then makes some definitions overlap or mislead others, such as emerging digital technologies such as social networking, mobile analytics, and embedded devices. It enables significant commercial benefits such as improved customer experience, improved processes, or the creation of new business models [12].

The Internet of things (IoT), 3D printing, the Industrial Internet of things (IIOT), Enterprise Resource Planning (ERP) Systems, Artificial Intelligence (AI), Machine Learning (ML), Big data (BD), and the convergence of physical manufacturing and digital technologies have all resulted from this revolution [13]. DT is inextricably linked to Industry 4.0, whether in the services or industrial sectors; it is the transformation that propels Industry 4.0 forward. Businesses are now ensuring that digitalization and automation eliminate mistakes that have the potential to harm their brand and result in massive financial losses. On the other hand, the pharmaceutical industry has a history of resistance to new technologies and digital solutions. Nonetheless, with the Covid-19 outbreak causing widespread concern and posing a continuing threat, digitalization appears to be the best way to ensure everyone has access to safe medication [2]. Environmental changes because of the growing population and pollution cause contention and disruption. Therefore, digitalization was required to address these environmental challenges while simultaneously increasing competition, and improving customer relations, productivity, profitability, effective planning, problem-solving, and decision-making to continue delivering medical items [14].

The pharmaceutical industries are extremely sophisticated in terms of technological use. However, in terms of operations, the sector has been quite conservative in embracing new technology thus far, relying on a long-established supply chain and manufacturing models [15]. The highly regulated environment in which pharmaceutical companies operate is an important factor. Digitalization has enormous potential to assist pharmaceutical businesses in addressing these difficulties of lack of integrated planning throughout the network. Companies across all industries are boosting operations through a collection of developing technologies known as Industry 4.0 [12].

### 3 Methodology

This section describes the nature of the data obtained and selected to achieve the research purpose. The approach used to select and analyse articles is the Systematic Literature Network Analysis (SLNA) [16]. In addition, the web of science, Google scholar and Scopus were considered for literature analysis (2004 to 2022) [9]. Out of the 63 articles, 14 were irrelevant abstracts, 16 were irrelevant to objectives, and 19 were used for the review.

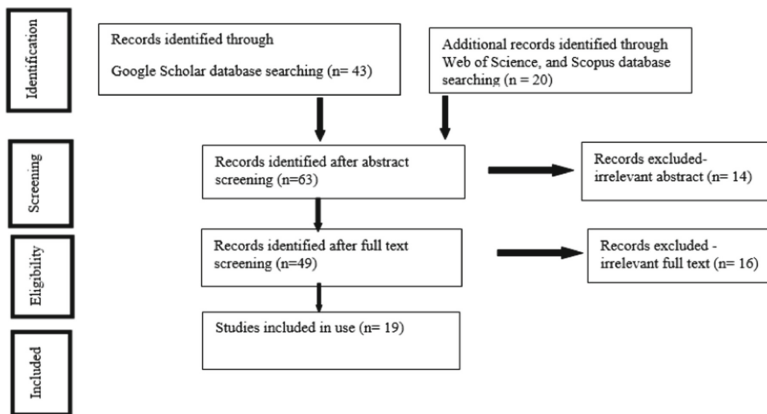


Fig. 1. Systematic Literature Review.

Figure 1 shows a structure crucial in performing a secondary investigation, such as a systematic literature review (SLR), to minimize bias in the study. The structure embodies the detailed plan for the review, specifying the process to be followed to achieve results and facts as findings [17].

### 4 Results and Findings

The research findings and results displayed seven important motives for DT and its benefits in the pharmaceutical sector, as well as the influences of digitalization. There are several reasons why the pharmaceutical industry needs to be digitalized. Some of the key motivations for digital enablement adoption in pharma are as follows [18]:

- The need for effective data management practices,
- Harnessing the expert knowledge of other industry players worldwide,
- Improving the frontiers of research related to the manufacturing of safe and quality pharma products,
- Supply chain complexities,
- The ever-changing needs of customers,
- Reducing production costs and increasing profitability, and
- The need for effective teamwork.

Developing clear data management strategies is essential to avoid running out of data centre space and financial resources in the pharmaceutical industry due to the day-to-day creation of data. This data is valuable to pharma sector researchers for many reasons, including improving clinical trials, developing personalized medicines, and advancing new product research [7]. Digitalization improves supply chain visibility and speeds decision-making. As a result of digitalization, companies are more adaptable and responsive and improve planning accuracy, manufacturing efficiency, inventory, and service levels [18]. A digital supply chain ecosystem with virtual supply chain control tools, cloud-based information architecture, and a digitally enabled physical supply chain is required to capitalize on this opportunity. People, machines, and resources communicate as a cyber-physical system, improving all stages of the operations value chain: plan, source, and make. In addition, it allows manufacturers and distributors to reach previously inaccessible customers [3].

According to the findings, internal and external factors significantly impact the adoption of DTs in the pharmaceutical industry. The development of new drugs is too expensive, and clinical approval times are too long; this is one of many internal factors influencing DT. However, technology such as AI can help with data science tools for smart experimental design, data-driven decision-making, and process optimization [19]. People with the necessary skills are scarce, making them expensive and limited in their time. Also, IoT, an enabler of CPS, interconnects real and digital components via embedded chips, sensors, and networks to create algorithms and replace judgments that rely on manual data analysis [20].

Given the time and money spent on drug R&D, medication discovery, clinical trials, product quality evaluation, pharma supply networks, and marketing, the pharmaceutical industry is unquestionably a large and complex ecosystem. As a result, understanding these forces will aid in developing appropriate structures or technologies to address the SWOT Pharma analysis (Fig. 2).

Figure 2 illustrates the four main quadrants that drive pharma digitalization transformation. Large capital investments are required to transform an organization's operations digitally. Pharmaceutical companies with larger financial cashflows have an advantage in adopting and implementing newer technologies. Brand image is critical to those in the pharmaceutical industry who are quickly adopting new technologies. Pharma executives at these companies are more likely to adopt and implement technologies that will further strengthen their market position. A deeper understanding of these technologies and more efficient ways of doing things, combined with structural flexibility, all contribute to the early adoption and implementation of digital enablers.



**Fig. 2.** SWOT Pharma Analysis, the four quadrants that identify pharma company strengths, weaknesses, opportunities for digitalization, and threats for adoption and implementation

Regardless of the propellers to digital enabler adaptation, low quality and production capacity, data silos, broken audit trails, and a lack of optimization for equipment and processes all impede the drive towards 4.0 pharma activities. Covid-19 Pandemic presented and accelerated the adoption of advanced technologies, hastening the development of vaccines [3]. This, along with other external factors such as customer demand, regulatory requirements from standard authorities, and conflicts such as the one between Russia and Ukraine, present opportunities to further enhance and expand the frontiers of digitalization in the pharmaceutical sector. However, there are some perceived barriers to DT adoption. These may include industry competition, supply chain complexities, the risk of reputational damage, data losses, and a variety of other unknowns.

Digitalizing the processes that support the pharmaceutical industry can significantly improve the quality of some critical industrial processes such as documentation and materials management, and logistical challenges, making them safer, more efficient, and more consistent. This considerably reduces the barrier of supply chain complexity, which is a big lure to the digitalization agenda. Furthermore, the study discovered that it has a higher impact when digitalization is applied to all aspects of a business. As a result, it is critical to determine whether there are any project dependencies or possible synergies. The digitalization of a process may affect other developments consistent with the work of [21]. As a result, to properly digitalize processes, it is important to identify cross-divisional activities and establish their ownership.

Finally, the study discovered that supply chain difficulties, worldwide pandemics such as Covid -19, demand shifts, and regulatory requirements all positively influenced the adoption of DT in the pharmaceutical sectors.

## 5 Conclusions and Further Research

Digitalization is unquestionably playing a key role in catalysing a paradigm change in the pharmaceutical sector. It can also be concluded that, despite significant efforts in digitalization over the past three years since Covid's initial strike, the pharmaceutical

industry has been resistant to digital implementation. It resulted in very slow progress in the sector's digitalization. As a result, production costs, employee skills, efficiency, customer satisfaction, breaking new ground and discovering cutting-edge quality products, enhanced digital platforms through data acquisition and protection, tracking various aspects of production, and many other factors are impacted. The push for a fully digitalized pharmaceutical industry is more pressing than ever primarily because digital platform enablers improve processes such as data collection, real-time information sharing of trial results, and the ability to track various aspects of productions. However, it also aids in reducing the complexities that have plagued the pharma industry over the years.

As with any other type of change, industry participants should expect challenges in managing these initiatives, as outlined above, employee resistance to the proposed change, flaws in the adoption process, and overall implementation lag. However, this can be effectively managed by engaging employees and providing training on new and innovative working methods while also committing to their job security and benefit.

The pharmaceutical sector must implement digital standards that ensure partner compatibility to address cybersecurity concerns. Pharmaceutical companies must also have the necessary resources, such as a multidisciplinary team of specialists and the funds to make the required investments. Technological advances will have an impact on the pharmaceutical industry. Industrial productions are linked with modern information and communication technology as part of the digitalization process, allowing for a self-organized manufacturing process and capturing important, usable data [21]. Further researchers are encouraged to broaden the scope of this research by investigating all other aspects of the pharmaceutical supply.

## References

1. Ayati, N., Saiyarsarai, P., Nikfar, S.: Short and long term impacts of COVID-19 on the pharmaceutical sector. *DARU J. Pharm. Sci.* **28**(2), 799–805 (2020). <https://doi.org/10.1007/s40199-020-00358-5>
2. Bedenkov, A., et al.: Developing medical affairs leaders who create the future. *Pharm. Med.* **34**(5), 301–307 (2020). <https://doi.org/10.1007/s40290-020-00351-y>
3. Lambert, H., et al.: COVID-19 as a global challenge: towards an inclusive and sustainable future. *Lancet Planet Health* **4**, e312–e314 (2020). [https://doi.org/10.1016/S2542-5196\(20\)30168-6](https://doi.org/10.1016/S2542-5196(20)30168-6)
4. Lee, S.L., et al.: Modernizing pharmaceutical manufacturing: from batch to continuous production. *J. Pharm. Innov.* **10**(3), 191–199 (2015). <https://doi.org/10.1007/s12247-015-9215-8>
5. Trollman, H., Jagtap, S., Garcia-Garcia, G., Harastani, R., Colwill, J., Trollman, F.: COVID-19 demand-induced scarcity effects on nutrition and environment: investigating mitigation strategies for eggs and wheat flour in the United Kingdom. *Sustain. Prod. Consum.* **27**, 1255–1272 (2021). <https://doi.org/10.1016/j.spc.2021.03.001>
6. Jagtap, S., et al.: The Russia-Ukraine conflict: its implications for the global food supply chains. *Foods* **11**, 2098 (2022). <https://doi.org/10.3390/foods11142098>
7. Belk, R.W.: Extended self in a digital world: table 1. *J. Consum. Res.* **40**, 477–500 (2013). <https://doi.org/10.1086/671052>

8. Fatorachian, H., Kazemi, H.: A critical investigation of Industry 4.0 in manufacturing: theoretical operationalisation framework. *Prod. Plan. Control* **29**, 633–644 (2018). <https://doi.org/10.1080/09537287.2018.1424960>
9. Carcary, M., Doherty, E., Conway, G.: A dynamic capability approach to digital transformation: a focus on key foundational themes. In: Dameri, R.P. (ed.) *Proceedings of the ECISM 2017 11th European Conference on Information Systems Management*, pp. 20–28 (2016)
10. Thoben, K.-D., Wiesner, S., Wuest, T.: “Industrie 4.0” and smart manufacturing – a review of research issues and application examples. *Int. J. Autom. Technol.* **11**, 4–16 (2017). <https://doi.org/10.20965/ijat.2017.p0004>
11. Kitson, P.J., et al.: Digitization of multistep organic synthesis in reactionware for on-demand pharmaceuticals. *Science* **2018**(359), 314–319 (1979). <https://doi.org/10.1126/science.aao3466>
12. Okafor, O., Weilhard, A., Fernandes, J.A., Karjalainen, E., Goodridge, R., Sans, V.: Advanced reactor engineering with 3D printing for the continuous-flow synthesis of silver nanoparticles. *React. Chem. Eng.* **2**, 129–136 (2017). <https://doi.org/10.1039/C6RE00210B>
13. Hurter, C., Ersoy, O., Fabrikant, S.I., Klein, T.R., Telea, A.C.: Bundled visualization of dynamic graph and trail data. *IEEE Trans. Vis. Comput. Graph.* **20**, 1141–1157 (2014). <https://doi.org/10.1109/TVCG.2013.246>
14. Carlsson, C.: Decision analytics—key to digitalisation. *Inf. Sci. (N Y)* **460–461**, 424–438 (2018). <https://doi.org/10.1016/j.ins.2017.08.087>
15. Mongeon, P., Paul-Hus, A.: The journal coverage of web of science and scopus: a comparative analysis. *Scientometrics* **106**(1), 213–228 (2015). <https://doi.org/10.1007/s11192-015-1765-5>
16. Arreola González, A., Pfaff, M., Krcmar, H.: Business model representations and ecosystem analysis: an overview. In: Themistocleous, M., Rupino da Cunha, P. (eds.) *EMCIS 2018. LNBIP*, vol. 341, pp. 464–472. Springer, Cham (2019). [https://doi.org/10.1007/978-3-030-11395-7\\_36](https://doi.org/10.1007/978-3-030-11395-7_36)
17. Brereton, P., Kitchenham, B.A., Budgen, D., Turner, M., Khalil, M.: Lessons from applying the systematic literature review process within the software engineering domain. *J. Syst. Softw.* **80**, 571–583 (2007). <https://doi.org/10.1016/j.jss.2006.07.009>
18. Rajadhyaksha, V., Patil, A.: Evolving role of pharmaceutical physicians in the industry: Indian perspective. *Perspect. Clin. Res.* **3**, 35 (2012). <https://doi.org/10.4103/2229-3485.92306>
19. Steinwandter, V., Borchert, D., Herwig, C.: Data science tools and applications on the way to Pharma 4.0. *Drug Discov. Today* **24**, 1795–1805 (2019). <https://doi.org/10.1016/j.drudis.2019.06.005>
20. Jeschke, S., Brecher, C., Meisen, T., Özdemir, D., Eschert, T.: Industrial internet of things and cyber manufacturing systems. In: Jeschke, S., Brecher, C., Song, H., Rawat, D.B. (eds.) *Industrial Internet of Things. SSWT*, pp. 3–19. Springer, Cham (2017). [https://doi.org/10.1007/978-3-319-42559-7\\_1](https://doi.org/10.1007/978-3-319-42559-7_1)
21. Cobelli, N., Chiarini, A.: Improving customer satisfaction and loyalty through MHealth service digitalization. *TQM J.* **32**, 1541–1560 (2020). <https://doi.org/10.1108/TQM-10-2019-0252>



**Open Access** This chapter is licensed under the terms of the Creative Commons Attribution 4.0 International License (<http://creativecommons.org/licenses/by/4.0/>), which permits use, sharing, adaptation, distribution and reproduction in any medium or format, as long as you give appropriate credit to the original author(s) and the source, provide a link to the Creative Commons license and indicate if changes were made.

The images or other third party material in this chapter are included in the chapter's Creative Commons license, unless indicated otherwise in a credit line to the material. If material is not included in the chapter's Creative Commons license and your intended use is not permitted by statutory regulation or exceeds the permitted use, you will need to obtain permission directly from the copyright holder.





# A Case Study on Evaluation of Defect Characteristics for Practical Application of Appearance Inspection Work Support System Utilizing Deep Learning

Yuta Nakakura, Kosuke Temizu, Mana Nishino, and Ryosuke Nakajima<sup>(✉)</sup>

The University of Electro-Communications, Tokyo, Japan  
nakajima@uec.ac.jp

**Abstract.** To prevent outflow of defective products to customers, many manufacturing industries have focused not only on processing and assembling, but also on product inspection. In appearance inspection, a work support system using deep learning has been proposed, and its usefulness was experimentally shown in model images of industrial product in recent years. Therefore, in this study, aiming for practical application of work support system, the relationship between the lighting angles and the visibility of defects is experimentally evaluated using 80 actual automobile parts as a case study. As results, it is found that the visibility of the defect greatly differs depending on the angle of lighting, and the conditions for high visibility differ depending on the defect. Furthermore, it is found that it is possible to improve the visibility of defects in about 24% of all 80 automobile parts, but, it is difficult to improve the visibility of defects for the remaining 76%. From the above, for the practical application of the work support system, it is clarified that the importance of constructing of lighting condition optimization method to improve the visibility of defects, and examining the input image considering the visibility of defects for deep learning.

**Keywords:** Appearance Inspection · Work Support · Machine Learning

## 1 Introduction

In manufacturing processes, appearance inspections are conducted to ensure that industrial products are free of scratches, stains, and other visible defects. During an appearance inspection, it is difficult to reliably detect a wide variety of defects that occur in the production process and correctly distinguish between good and defective products simultaneously based on appearance inspection standards. Therefore, human visual (sensory) inspection is used commonly in the field. In addition, as production patterns shift to high-mix low-volume production schemes, automated inspections have not progressed because they are not cost-effective in terms of development, introduction, and operation costs [1].

In response to these problems, recent studies focusing on appearance inspection have taken an ergonomic approach to human visual inspection [2], as well as an approach

using image processing and machine learning [3] for machine-based visual inspection, aiming to improve inspection accuracy and efficiency. Recently, a work support system has been proposed that combines the findings of the two approaches, in which a machine searches for defects and a human inspector categorizes the results. The effectiveness this approach has been experimentally demonstrated on model images that imitate industrial products [4]. Specifically, the work support concept entails using a camera to capture images of the product before it is sent to the human inspector and presenting the results of the computer analysis to the human inspector on a display, so that only potentially defective items are inspected.

The work support system can be configured using commercially available inexpensive cameras and computers that conduct machine learning (Deep Learning) with product images as input; there is no need to set individual features for each product. In other words, this approach directly addresses the cost-effectiveness issue discussed above and could be widely applicable to many industrial products.

However, the usual defects in actual industrial products have certain characteristics that affect the visibility of defects greatly depending on the lighting conditions [5]. Therefore, product images taken under appropriate lighting conditions should be used as input images. The usefulness of the work support system has not yet been demonstrated while considering such defect characteristics.

Therefore, in this study, we experimentally evaluate the relationship between lighting condition and visibility of defects as a case study on actual automobile parts. Our objective is to study the practical applicability of the work support system based on an understanding of the defect characteristics.

## 2 Experimental Design

### 2.1 Target Products and Image Capture Environment

The target products collected and used were 80 defective automobile parts measuring 87.5 mm in length and 440.0 mm in width produced by Company A. The breakdown of defects in the 80 parts was, 20 bumps, 14 scratches, 11 dust spots, 7 paint over-sprays, 8 thread debris, 7 dents, 6 irregularities, 4 white spots, and 3 stains. In the image capture environment, shown in Fig. 1, the camera (Nikon, D5500) and target product were fixed in position. Moreover, two planar illuminators (SUNTECH, LG-E268C) were used at different positions and angles to capture images under various lighting conditions.

### 2.2 Experimental Factors

Nine types of defects (bumps, scratches, dust spots, paint over-sprays, thread debris, dents, irregularities, white spots, and stains) were used as experimental factors. As shown in Fig. 2, the angle  $\theta$  between the illuminator and target product was set at five settings ( $-60^\circ$ ,  $-30^\circ$ ,  $0^\circ$ ,  $30^\circ$ , and  $60^\circ$ ). Note that  $0^\circ$  is the position perpendicular to the target product,  $-60^\circ$  and  $-30^\circ$  denote position after counterclockwise rotation, and  $30^\circ$  and  $60^\circ$  denote position after clockwise rotation. Based on these experimental factors, a total of 400 images were captured and used in the experiment for a combination of 80 defective products (9 types) with 5 lighting angle settings.

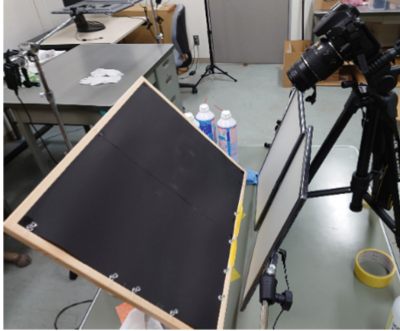


Fig. 1. Image capture environment.

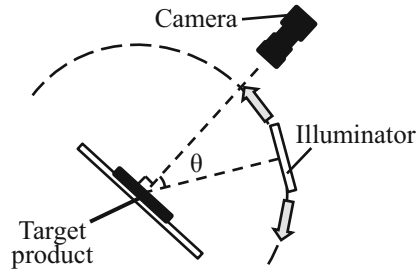


Fig. 2. Experimental factor

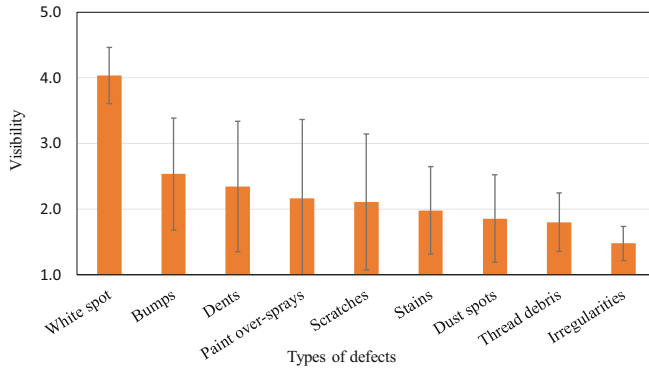
### 2.3 Methods for Evaluating Visibility of Defects

Three university students (including graduate students) aged 21 to 24 years participated as evaluators to conduct subjective evaluation of a total of 400 images on a 5-point scale of 1 (invisible), 2 (somewhat visible), 3 (visible), 4 (somewhat easily visible), and 5 (easily visible). The mean and standard deviation of the scores given by the three evaluators for each image were then used as the values for evaluating the visibility of defects. In this study, university students with no experience in appearance inspection were recruited as evaluators but we believe that it is necessary to recruit experts in the appearance inspection processes as evaluators in the future.

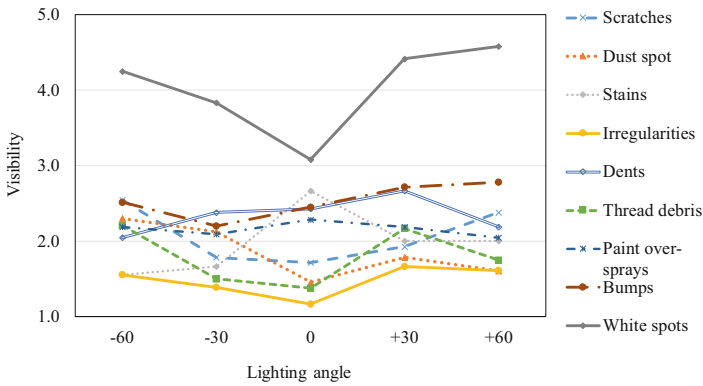
## 3 Experimental Results

The mean and standard deviation of the evaluated defect values are shown in Fig. 3, which depicts that the highest visibility rating was 4.0 for white spots and lowest was 1.5 for irregularities, indicating that visibility varies greatly depending on the type of defect. It was also observed that the standard deviation was large for some types of defects, such as bumps and paint over-sprays, and visibility of defects differed even for the same type of defect.

Next, the evaluation values with respect to lighting angle for each defect are shown in Fig. 4. The figure depicts that the effect of lighting angle differs depending on the defect type. For example, some defects, such as white spots and scratches, have higher visibility ratings at  $-60^\circ$  and  $60^\circ$ , while others, such as stains, have higher ratings at  $0^\circ$ , and some defects, such as paint over-sprays and bumps, have the same level at all lighting angles.



**Fig. 3.** The mean and standard deviation of the evaluated defect values

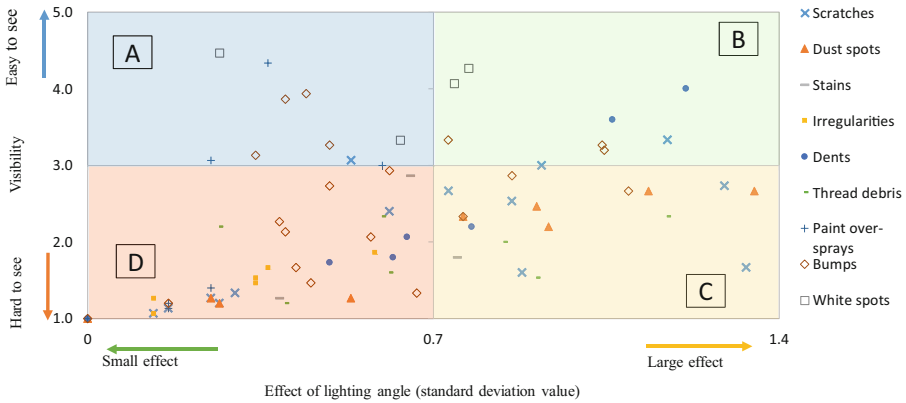


**Fig. 4.** The evaluation values with respect to lighting angle for each defect

## 4 Discussion

The experimental results demonstrated that visibility differs for each defect type, as well as the same defect type under different lighting conditions. Furthermore, the effect of lighting angle differs depending on the type of defect. Therefore, a plot of the mean and standard deviation values of the evaluation results for each individual defect is shown in Fig. 5. The figure clearly demonstrates that it is important to evaluate and understand the characteristics of individual defects as well as their types and consider their applicability to work support systems because some defects of the same type have different characteristics.

If Fig. 4 is divided into four quadrants, defects in the second quadrant are visible regardless of the lighting angle and are categorized as a group of defects that are easily detected by the work support system. The defects belonging to the first quadrant may be visible depending on the lighting angle and are considered to be detectable by the work support system by appropriately considering the image capture conditions of the input image. However, we can also confirm that only approximately 24% of all the defects



**Fig. 5.** a plot of the mean and standard deviation values of the evaluation results for each individual defects

belong to the first and second quadrants. In contrast, the number of defects belonging to the third and fourth quadrants was approximately 76% of the total. Subsequently, we determined that measures need to be considered for practical use because the product images as they are cannot be effective inputs to the work support system for the target products considered in this study.

The abovementioned findings elucidated that to put the work support system into practical use, it is important to construct a methodology to further pursue lighting conditions that increase the visibility of defects and take images considering the visibility of defects as input images for deep learning.

## 5 Conclusion

In this study, the relationship between lighting condition and defect visibility was experimentally evaluated using 80 actual automobile parts to realize a novel appearance inspection method based on human-machine integration. The results confirmed that the visibility and its characteristics differ for each type of defect, as well as the same type of defect under different lighting conditions. We also found that for about 24% of the total of 80 defects the visibility was sufficiently high depending on the lighting condition, while for the remaining 76%, the visibility was not sufficiently ensured. These findings elucidated that to put the work support system into practical use, it is important to construct a methodology to further pursue lighting conditions that increase the visibility of defects and take images that consider the visibility of defects in input images for deep learning.

In future studies, we would like to use inspectors who are field experts as evaluators to assess more detailed defect characteristics, propose appropriate lighting conditions based on a better understanding of the defects, and apply the subsequent result to the work support system to confirm its usefulness.

**Acknowledgment.** This study was partly supported by JSPS Grant-in-Aid for Young Scientists (22K14439).

## References

1. Chugoku Regional Innovation Research Center.: [Survey on the feasibility of promoting automation of inspections at production sites of manufacturing companies.]*Monodukuri kigyō no seisan genba ni okeru kensa no jidōka sokushin kanousei chōsa* (2016)
2. Akio, S.: [Peripheral visual inspection method] *Shuhen shi mokushi kensa hou*. [I] In: IE review, The Japan Institute of Industrial Engineering, vol. 46, No. 4, pp. 65–75 (2005)
3. Chengkan, L., Zengtao, Z., Fei, S., Feng Z., Hu. S.: A fast surface defect detection method based on background reconstruction. *Int. J. Prec. Eng. Manuf.* **21**(3), 363–375 (2019)
4. Hidenori, K.M., Ryosuke, N.: [Basic research on the development of a work support system for visual inspection using Deep Learning] *Deep Learning wo mochiita gaikan kensa no sagyou shien system no kaihatu ni kansuru kiso kenkyu*. In: Japan Industrial Management Association Spring Conference 2020, pp. 6–7 (2020)
5. Ryosuke, N., Keisuke, S., Toshiyuki M.: A study on the effect of irradiation angle of light on defect detection in visual inspection. *Int. J. Indust. Eng. Theory Appl. Pract.* **22**(1), 525–537 (2015)

**Open Access** This chapter is licensed under the terms of the Creative Commons Attribution 4.0 International License (<http://creativecommons.org/licenses/by/4.0/>), which permits use, sharing, adaptation, distribution and reproduction in any medium or format, as long as you give appropriate credit to the original author(s) and the source, provide a link to the Creative Commons license and indicate if changes were made.

The images or other third party material in this chapter are included in the chapter's Creative Commons license, unless indicated otherwise in a credit line to the material. If material is not included in the chapter's Creative Commons license and your intended use is not permitted by statutory regulation or exceeds the permitted use, you will need to obtain permission directly from the copyright holder.





# Framework for the Development and Implementation of Sustainable Information Systems for the Digitalization of Small Businesses in South Africa

Ryan Parker<sup>(✉)</sup> and Stephen Matope

Stellenbosch University, Stellenbosch 7600, WC, South Africa  
ryanneilparker@gmail.com

**Abstract.** In this paper, a framework for the development and implementation of a low-cost, “low-code”, information system, for the digitalization of small businesses, in the retail and manufacturing sectors is developed and employed. The purpose of this framework is to enable small businesses, that lack the technical expertise and financial resources to invest in proprietary information system technology, to develop systems by leveraging freely available cloud-based tools like Google Forms, Google Sheets, and Google Sites. A thorough literature review of the concept of digitalization is conducted. Thereafter, a small business suitable for digital transformation is identified. Based on the system requirements an information system relevant to the business is developed and implemented. Finally, guidelines are proposed for the development and implementation of similar systems in other small businesses.

**Keywords:** framework · digitalization · information system

## 1 Introduction

The terms digitization and digitalization are used interchangeably in the literature. However, for the purposes of this paper, a clear distinction is made between digitization and digitalization. Digitization refers only to the conversion of analog information, such as a paper document, into a digital format such as a pdf document [1]. Digitalization is a more encompassing term and refers to the ongoing transformation of business processes because of new digital technologies [2]. Organizations have long recognized the importance of managing key resources such as people and raw materials. Now, information has moved to its rightful place as a key resource. Decision-makers understand that information is not just a by-product of conducting business; rather, it fuels business and can be the critical factor in determining the success or failure of a business [3]. Until recently, there has been slow progress towards leveraging information as a resource amongst small South African businesses, perhaps the result of more than half of its citizens living below the poverty line [4]. However, since the onset of the Covid-19 pandemic SMEs, which make up over 98% of businesses and employ more than 50%



of workers in South Africa, have begun their digital transformation [5]. In 2018 PWC's Strategy and Global Digital Operations study found that only 10% of global manufacturing companies were considered "Digital Champions", whilst almost two-thirds had barely begun or had not yet begun the digital transformation journey [6]. In 2022, the race toward digitalization is in full swing, but the truth is that most small South African businesses lack the resources and skills to make the transition to a digital, data-driven business model [7]. If these businesses are to compete in the modern digital environment, then harnessing the power of the data they generate will be paramount. However, this poses a difficult question "How do small businesses rapidly harness the power of their data at low cost, with low skills, and in an environmentally sustainable way?". Digitalization is a resource-intensive process and involves the production of computing equipment, the design of software and database infrastructure, and the cost of maintaining and operating a system once in place [8]. The environmental impact of constructing server rooms, writing software, and maintaining the systems themselves is huge [9]. Moreover, alternatives such as Software as a Service (SaaS) can be prohibitively costly. The solution lies in being able to construct information systems in a low-cost, low-skill manner and bring them to life using sustainable cloud infrastructure. Not every company can afford to power its servers with renewable energy, but Google can.

## 2 Literature Review

### 2.1 Concept

Digitalization is defined by Gartner [10] as "The use of digital technologies to change a business model and provide new revenue and value-producing opportunities; it is the process of moving to a digital business.". This covers the implementation of the technology required to support digital systems, as well as the updating of business models to synergize with the capabilities of the new technology. The image of factory workers laying down their hand tools and learning to operate automated machines springs to mind. Digitalization can be divided into 4 overarching levels [11]: (1) process level: streamlining processes by adopting new digital tools and reducing manual steps, (2) organizational level: offering new or improved services and discarding obsolete practices, (3) business domain level: changing roles and value chains in ecosystems, (4) societal level: changing societal structures (e.g., type of work, means of influencing societal decision making). The framework discussed here is germane to the process level of digitalization.

### 2.2 Benefits

Globally, the application of digital technologies in SMEs has disrupted and revolutionized many industries and organizations [12, 13]. There are a variety of benefits associated with digitalization including replacing manual steps in information-intensive processes, resulting in more streamlined and effectual actions [11]. Moreover, data tracked in real-time allows workflows to become more transparent [14], and identifies areas in need of process improvement, which can result in cost reduction [15, 16]. The more parts along the value chain that are digitalized the greater the resource savings as fewer people, less

work, and more data visibility enable greater control, foresight, planning, and decision making [17]. Without the means to implement information systems small businesses in South Africa are left at a disadvantage.

### **2.3 Limitations**

Digitalization has great promise, but it is not without its limitations. Digitalization typically requires advanced computing infrastructure like servers, and or datacenters. Usually, the associated software must be created or bought from other companies. Creating on-site information systems requires highly skilled workers, time, and money [18]. Buying software and offsite infrastructure often limits the capabilities the organization might be able to derive from the system and comes at a premium, often recurring, cost [19]. Neither of these solutions hold much promise for a low income and technologically limited small business owner.

### **2.4 Sustainability**

As the use of information technology becomes more ubiquitous, the need for data processing and storage capabilities increases. This results in the construction and operation of large data center facilities that house thousands of servers and serve as the backbone for all types of computational processes [20]. Unfortunately, as processing power and storage capacity increase, so do the corresponding power and cooling requirements of the data centers. Several studies have examined the efficiency of data centers by focusing on server and cooling power inputs, but this fails to capture the data center's entire impact [21–23]. To fully account for the environmental impact of these resources the materials, manufacture, and transportation of the servers themselves should also be considered. Large, centralized data centers can offset the emissions of manufacturing by distributing the required compute over many servers and using algorithmic control of power supplies, minimizing idle time, and maximizing resource utilization [24, 25]. For many small businesses, the capital involved in this is prohibitive. However, many do have access to at least one computer or a mobile phone, which could be used as a link to an outsourced data center.

### **2.5 Mobile and Cloud**

A promising solution to the problem of high energy consumption is the use of “green data centers”. That is, data centers that run primarily on green renewable energy. Google has been carbon neutral since 2007, currently matches 100% of its energy consumption with renewable energy and has eliminated its entire carbon legacy pre-2007 through the purchase of high-quality carbon offsets [26]. Not all companies can afford to run such a clean data center and thus the prospect of outsourcing the hardware needs to Google is attractive. Furthermore, small businesses stand to benefit from the suite of free cloud-based applications like Google Sheets, and Google Sites, which are all integrated into the Google Cloud ecosystem. The use of these applications requires little to no training, and they are accessible for free to anyone, anywhere, anytime. Moreover, the fact that it is cloud-based and mobile-friendly means that the user would need little more than a smartphone to leverage these services.

## 2.6 Existing Research

Previous research has focused on implementation in companies that are well established and have the economic resources to develop or buy their own information systems [27]. Furthermore, the high investment requirements for new I4.0 applications and limited availability of skilled staff are regarded as the biggest obstacles to I4.0 implementation [28]. The purpose of this paper is to explore the potential of using free cloud-based software to allow low-income, unskilled business owners to build their own information systems. Research in this area is sparse as it is generally assumed that financial resources are a prerequisite for the development of an information system [29]. However, the emergence of the cloud has opened new avenues that may potentially allow these unskilled individuals to leverage technologies previously inaccessible to them. Using Google as the model of a cloud-based “green data center” and their suite of free cloud-based applications and tools the proceeding methodology seeks to design and implement an information system that could be replicated by a small business, even without advanced skills or large capital outlay.

## 3 Methodology

### 3.1 Candidate Selection and Analysis

A candidate business was selected on the grounds of its apt representation of a small, paper-based business in South Africa. The business was analyzed and discussions with the owner and employees were conducted. Key areas of interest were identified and added to the system to maximize its utility without allowing the system architecture to become overcomplicated. The business processes associated with the new system were analyzed, improved, and redesigned to interface with the system.

### 3.2 System Specifications

Interviews and discussions with the stakeholders of the business eventually generated a list of requirements for the system. Potential additions to the system were scrutinized and only the requirements with the greatest potential return on investment were used to minimize complexity. The user requirements were further processed into a set of system requirements which were then finally reduced to a set of specifications that the system must meet to satisfy the needs of the business.

### 3.3 System Architecture

The tools used for synthesizing the system were restricted to those that are freely available and mobile friendly. The ecosystem of applications used included Google Forms (data capture), Google Sheets (data storage), Google Data Studio (data processing), Google Sites (interfacing host), and Scan2Web (QR code scanner). The system was designed to be usable with only a smartphone and is almost entirely cloud based apart from the QR scanning app which must be installed onto the user’s phone.

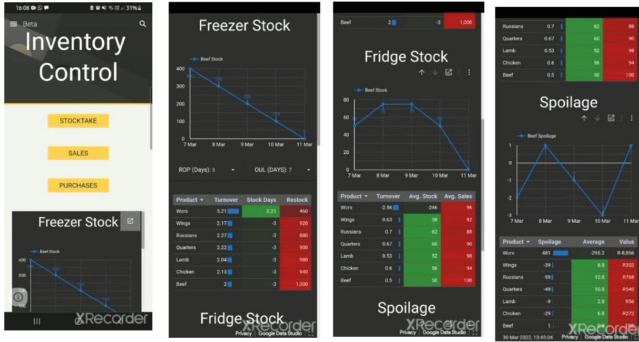


Fig. 1. A collection of screenshots of the mobile friendly interface showing the UI and chart outputs for some dummy data.

### 4 Results

The resulting information system was focused on kitchen stock control. The user interface takes the form of a website, hosting forms for data capture and reports displaying graphical analysis of the data. The stock level of the freezer and fridge are shown as line charts which can be filtered by product and aggregated at various time intervals. Several KPIs including spoilage and stock days remaining are calculated and displayed on the website (see Fig. 1, above).

#### 4.1 Candidate Selection and Analysis

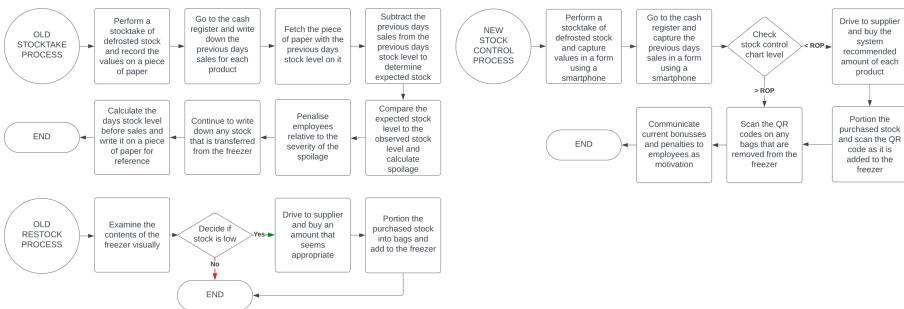


Fig. 2. A comparison of the old and new business processes (ROP stands for Re-Order Point).

“Chisa nyama (also spelled shisa nyama or chesa nyama) is a Zulu word - literally meaning ‘burn meat’ - used to describe a popular ‘buy-and-braai’ style of venue found across South Africa, particularly in townships. At a chisa nyama, you choose your own meat from an attached butchery and then have it barbecued, or in some cases ‘braai’ (barbecue) it yourself.” [30]. A chisa nyama operating out of Bellville, Cape Town was selected. The small business was paper-based, and the owners did not have access

to anything beyond a smartphone and a cash register that can print receipts and sales reports. Analysis of the current business processes, including discussions with the owner and employees, eventually led to the coda that tracking of kitchen stock levels held the greatest potential for improvement. This choice was motivated by high uncertainty surrounding the true stock levels in the kitchen, excessive theft, spoilage of stock, and disproportionate labor allocation towards stocktaking activities. The associated business processes were redesigned to incorporate the new technology and streamline the tasks of the worker (see Fig. 2, above).

### 4.2 System Requirements and Specifications

See Table 1

**Table 1.** A table summarizing the conversion of user requirements into system specifications.

User Requirements	System Requirements	System Specifications
See the current stock levels of frozen and defrosted stock	Track freezer stock transactions	QR scanner, calculate stock levels, store in a normalized table, and display as a time-series line chart
Be able to track and monitor spoilage	Compare daily stock takes to expected stock levels	Stocktake form, calculate spoilage, store in a normalized table, and display as a time-series line chart
Decide when to order stock and in what quantity	Track average demand and calculate stock control KPIs	Sales form, calculate average demand, calculate stock control KPIs, and display KPIs in a table

### 4.3 System Architecture

The system was split up into three distinct modules, namely data capture, data processing, and data visualization. The first module relied primarily on the use of web forms created in Google Forms, in addition to a QR scanning app, to capture data from business operations. It consists of three forms for capturing purchases, sales, and stocktakes and the app for tracking freezer stock. The second module processes that data with Google Sheets into normal data tables. The normalized data tables were used as a database to feed Google Data Studio which then output visualizations of the data in the form of charts and KPI's. Lastly all three modules were hosted in a Google Sites website for easy navigation between capturing and viewing data.

## 5 Discussion

The reception from employees was positive with many stating the system had eased their workloads. Furthermore, management reported that they had greater control over their stock and were able to eliminate or decrease several sources of waste. The owner is grateful for the mobile interface as there was no need to buy a computer.

## 6 Conclusion

The methodology proved to be a viable way for a small business to begin their digital transformation. The benefits were tangible and achievable. It is recommended that anyone attempting to replicate this methodology research relational databases and systems design. The system whilst successful still suffers from several limitations. Developing complex algorithms or logic using only Google Sheets is challenging. Further, the row limit of one million data entries per sheet means that the database would eventually need to be cleaned out to avoid obsolescence.

## References

1. (2022) <https://www.collinsdictionary.com/dictionary/english/digitize>. Accessed 21 Jul 2022
2. (2022) What is Digitalization | IGI Global. In: Igi-global.com. <https://www.igi-global.com/dictionary/it-strategy-follows-digitalization/7748>. Accessed 21 Jul 2022
3. Kendall, K., Kendall, J.: Systems Analysis and Design, 10th ed. Pearson, Hoboken, New Jersey (2019)
4. (2022) Poverty Rate by Country 2022. In: Worldpopulationreview.com. <https://worldpopulationreview.com/country-rankings/poverty-rate-by-country>. Accessed 21 Jul 2022
5. (2022) Digitalisation – the best hope for South Africa and its small firms. In: Small-businessinstitute.co.za. <https://smallbusinessinstitute.co.za/wp-content/uploads/2019/02/Digitalisation-Paper-March-2021.pdf>. Accessed 21 Jul 2022
6. (2022) Global Digital Operations Study 2018 Digital Champions. In: pwc.com. <https://www.strategyand.pwc.com/gx/en/insights/industry4-0/global-digital-operations-study-digital-champions.pdf>. Accessed 21 Jul 2022
7. Kalidas, S., Magwentshu, N., Rajagopaul, A.: How South African SMEs can survive and thrive post COVID-19 (2020). In: mckinsey.com. <https://www.mckinsey.com/featured-insights/middle-east-and-africa/how-south-african-smes-can-survive-and-thrive-post-covid-19>. Accessed 21 Jul 2022
8. Veneck, A.: The Cost of Digital Transformation | Lightico. In: Lightico (2022). <https://www.lightico.com/blog/the-cost-of-digital-transformation/>. Accessed 21 Jul 2022
9. Schiettekatte, A.: Environmental impact of producing and operating server infrastructure: a systematic literature review (2021)
10. (2022) Definition of Digitalization - Gartner Information Technology Glossary. In: Gartner. <https://www.gartner.com/en/information-technology/glossary/digitalization>. Accessed 21 Jul 2022
11. Parviainen, P., Tihinen, M., Kääriäinen, J., Teppola, S.: Tackling the digitalization challenge: how to benefit from digitalization in practice. *Int. J. Inf. Syst. Proj. Manag.* **5**, 63–77 (2017). <https://doi.org/10.12821/ijispm050104>

12. Ziyae, B., Sajadi, S.M., Mobaraki, M.H.: The deployment and internationalization speed of e-business in the digital entrepreneurship era. *J. Glob. Entrep. Res.* **4**(1), 1–11 (2014). <https://doi.org/10.1186/s40497-014-0015-2>
13. Celuch, K., Bourdeau, B., Saxby, C., Ehlen, C.: SME internet use: the moderating role of normative influence. *J. Small Bus. Strateg.* **24**(2), 69–90 (2014)
14. Arkhipova, D., Bozzoli, C.: Digital capabilities. In: Bongiorno, G., Rizzo, D., Vaia, G. (eds.) *CIOs and the Digital Transformation*, pp. 121–146. Springer, Cham (2018). [https://doi.org/10.1007/978-3-319-31026-8\\_8](https://doi.org/10.1007/978-3-319-31026-8_8)
15. Hui, G.: How the Internet of Things Changes Business Models. In: *Harvard Business Review* (2014). <https://hbr.org/2014/07/how-the-internet-of-things-changes-business-models>. Accessed 21 Jul 2022
16. Livari, M., Ahokangas, P., Komi, M., tihinen, M.: Toward ecosystemic business models in the context of industrial internet. *J. Bus. Models* **4**, 42–59 (2016)
17. Rosin, A., Proksch, D., Stubner, S., Pinkwart, A.: Digital new ventures: assessing the benefits of digitalization in entrepreneurship. *J. Small Bus. Strateg.* **30**, 59–71 (2020)
18. Peatfield, H.: How much does ERP cost? (Free ERP cost and budget guide). In: *Erpfocus.com* (2021). <https://www.erpfocus.com/erp-cost-and-budget-guide.html#:~:text=A%202020%20ERP>. Accessed 21 Jul 2022
19. (2022) Cloud Price List | Oracle South Africa. In: *Oracle.com*. <https://www.oracle.com/za/cloud/price-list.html>. Accessed 21 Jul 2022
20. Hannemann, C., Carey, V., Shah, A., Patel, C.: Lifetime exergy consumption as a sustainability metric for enterprise servers. In: *ASME 2008 2nd International Conference on Energy Sustainability*, vol 1. (2008). <https://doi.org/10.1115/es2008-54181>
21. Jones, N.: How to stop data centres from gobbling up the world's electricity. *Nature* **561**, 163–166 (2018). <https://doi.org/10.1038/d41586-018-06610-y>
22. Kistowski, J., Block, H., Beckett, J., et al.: Analysis of the influences on server power consumption and energy efficiency for CPU-intensive workloads. In: *Proceedings of the 6th ACM/SPEC International Conference on Performance Engineering* (2015). <https://doi.org/10.1145/2668930.2688057>
23. Chait, K., Juiz, C.: Research line on improving energy efficiency in web servers. In: *2013 World Congress on Computer and Information Technology (WCCIT)* (2013). <https://doi.org/10.1109/wccit.2013.6618699>
24. Ciesielczyk, T., Cabrera, A., Oleksiak, A., et al.: An approach to reduce energy consumption and performance losses on heterogeneous servers using power capping. *J. Schedul.* **24**, 489–505 (2020). <https://doi.org/10.1007/s10951-020-00649-4>
25. Coady, Y., Hohlfeld, O., Kempf, J., et al.: Distributed cloud computing. *ACM SIGCOMM Comput. Commun. Rev.* **45**, 38–43 (2015). <https://doi.org/10.1145/2766330.2766337>
26. Pichai, S.: Our third decade of climate action: realizing a carbon-free future. In: *Google* (2020). <https://blog.google/outreach-initiatives/sustainability/our-third-decade-climate-action-realizing-carbon-free-future/>. Accessed 21 Jul 2022
27. Yap, C., Soh, C., Raman, K.: Information systems success factors in small business. *Omega* **20**, 597–609 (1992). [https://doi.org/10.1016/0305-0483\(92\)90005-r](https://doi.org/10.1016/0305-0483(92)90005-r)
28. Schmitt, P., Schmitt, J., Engelmann, B.: Evaluation of proceedings for SMEs to conduct I4.0 projects. *Procedia CIRP* **86**, 257–263 (2019). <https://doi.org/10.1016/j.procir.2020.01.007>
29. Premkumar, G.: A meta-analysis of research on information technology implementation in small business. *J. Organ. Comput. Electron. Commer.* **13**, 91–121 (2003). [https://doi.org/10.1207/s15327744jocce1302\\_2](https://doi.org/10.1207/s15327744jocce1302_2)
30. (2022) A South African Chisa Nyama. In: *Inyourpocket.com*. [https://www.inyourpocket.com/johannesburg/a-south-african-chisa-nyama\\_74233f](https://www.inyourpocket.com/johannesburg/a-south-african-chisa-nyama_74233f). Accessed 21 Jul 2022

**Open Access** This chapter is licensed under the terms of the Creative Commons Attribution 4.0 International License (<http://creativecommons.org/licenses/by/4.0/>), which permits use, sharing, adaptation, distribution and reproduction in any medium or format, as long as you give appropriate credit to the original author(s) and the source, provide a link to the Creative Commons license and indicate if changes were made.






The images or other third party material in this chapter are included in the chapter's Creative Commons license, unless indicated otherwise in a credit line to the material. If material is not included in the chapter's Creative Commons license and your intended use is not permitted by statutory regulation or exceeds the permitted use, you will need to obtain permission directly from the copyright holder.







# Sustainable Solutions by the Use of Immersive Technologies for Repurposing Buildings

Maximilian Rosilius<sup>1</sup> , Markus Wilhelm<sup>1</sup> , Ingo von Eitzen<sup>2</sup> ,  
Steffen Decker<sup>3</sup> , Sebastian Damek<sup>4</sup> , and Volker Braeutigam<sup>1</sup> 

<sup>1</sup> Technical University of Applied Sciences Würzburg-Schweinfurt, Ignaz-Schön-Straße 11,  
97421 Schweinfurt, Germany

maximilian.rosilius@thws.de

<sup>2</sup> Julius-Maximilians-Universität Würzburg, Sanderring 2, 97070 Würzburg, Germany

<sup>3</sup> Simplifier AG, Nürnberger Str. 47A, 97076 Würzburg, Germany

<sup>4</sup> University of Applied Sciences Erfurt, Altonaer Straße 25, 99085 Erfurt, Germany

**Abstract.** In the context of urban production and sustainable reuse of existing buildings, a detailed planning of the later usage is indispensable. One approach is to enable large-scale AR simulation on site with a sufficient Level of Detail (LoD) and stability. To determine performance metrics, a technology-stack is created and presented that enables a realistic field experiment in an industrial environment (area of 1,314 m<sup>2</sup>) using Microsoft HoloLens 2. For the experiment, a 3D model was instantiated as often as possible up to the limit of system stability and in different LoDs (100% down to 10%). The result shows that it is feasible to represent 2.63 million polygons (equivalent to about 1,909 m<sup>3</sup> of augmented space) on LOD-35%; LoD-100% is equivalent to 327.38 m<sup>3</sup> and 1,284 million polygons. Polygonal density [polygons/m<sup>3</sup>] is introduced as new indicator for better comparability when using 3D models. Thus, it is possible to immersively visualize urban production planning processes in large-scale scenarios. This expands the functional planning space of Urban Production and overcomes previous technical limitations.

**Keywords:** Augmented Reality · Urban Production · Large Scale Industry Scenario · Industrial Metaverse · Stability · Resilience · Rendering · Performance · Sustainability

## 1 Introduction

Current research contributions identify possible synergies from digitization and sustainability [1, 2]. In contrast to typical definitions of sustainability, which are mainly characterized by environmental, social and economic factors, there are also domain-specific factors. In the industrial context, sustainability also refers to areas such as emissions, products and services, transportation, appropriate working conditions, community relations, economic performance, and market presence [3]. These areas of industrial sustainability are enhanced by utilizing modern concepts of urban production (UP). UP is defined as a production system that creates value for real goods and services based on

transformative processes of input flows in urban space [4, p. 28]. UP of sustainable products is enabled by city-friendly factories and production systems on behalf of all partners [5]. This paper presents a technology stack as an immersive tool for UP concepts with its direct contribution to sustainability. In addition, the reliability and performance of the system under the constraints of UP requirements and their indirect effects towards sustainability are discussed [6–8].

## 2 Related Work

The symbiosis of the UP provides a sustainable contribution to the optimization of the ecosystem and the minimization of negative effects in several aspects [5]. Workplace and residential areas can merge and the social benefits can offer a more flexible work-life balance [9]. Energy and exhaust heat recovered from industrial processes can be made available for heating private housing due to sector coupling for example [10]. A main strategy of UP rests in the efficient use of already existing infrastructure and its sealed areas for sustainable industrial use [11]. To improve the competitive market position and to enhance the regional economy, the local, decentralized potentials of manufacturers, customers, services and lean supply chains can be used efficiently [12].

One challenge is the ‘space dilemma’, which is the lack of industrially available space versus the increasing need for production space to ensure growth and value creation [11 p. 3]. UP fulfils the requirements for the sustainable repurposing of vacant buildings in the so-called ‘Greyfields’ to avoid unnecessary sealing of surfaces. The challenges of sustainable industrial parks in urban environments are not only in the appropriate site selection, but also in the implementation, considering constraints such as space and cost issues, regulatory issues, emissions, pollution, odors, noise, vibrations, planning, construction, logistics and traffic [12]. The realignment of production to be designed with the involvement of all stakeholders, taking into account life-friendly conditions in terms of optimization, growth, customer integration and resource sharing [12].

For the assessment of potential locations and variants of the UP concepts, different methods are suggested. Augmented Reality (AR) can support the five stages of evaluation (analysis, scenario development, location selection, scenario evaluation and planning implementation) [13] and improve planning processes in general [14]. Stakeholders and developers of UP planning concepts can be displayed relevant, contextual information straight ahead in the field of view at the place of fulfilment [15].

## 3 Concept

The conclusion of the related work indicates that the objectives of the UP concepts can be sustainably supported by the use of augmented reality technology in decision-making and concept development. Based on the ‘ultra-efficiency approach’ [16], an immersive implementation is created. This allows the relevant interrelationships of the five areas, including material (white lines), energy (orange lines), people (yellow lines) and emissions (violet lines), to be displayed and examined in an AR simulation at the point of performance (Fig. 1) [16].



**Fig. 1.** Mockup of an AR UP scene with production and distribution close to the customers. In the scenario, both interconnection (highlighted purple emissions, orange energy, yellow people, white material) and value stream planning combined with sector coupling (utilisation of process heat and excessive energy for private residences) are based on [16]

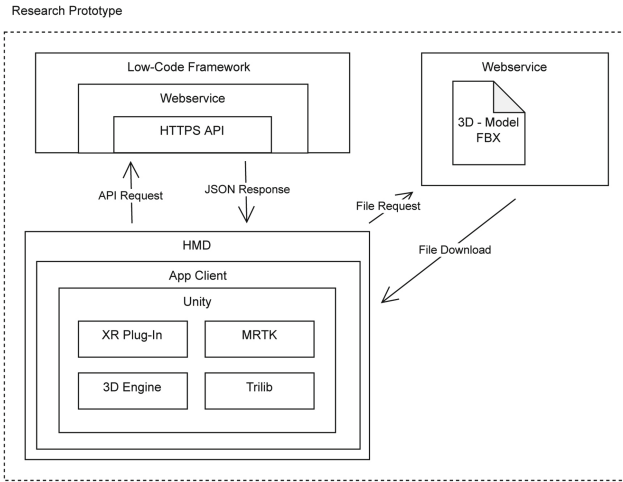
### 3.1 Research Demand and Research Question

In this context, the research demand focuses on the challenge of a resilient, usable AR planning application that fulfils the requirements of the UP dimensions including the necessary rendering performance. These challenges are met in a mixed reality application comparable to the mobile AR field [17]. The present research design is designed to meet the following research question: *What is the maximum amount of augmented volume or how many 3D models can be rendered in one AR scene as a function of the level of detail (LoD) using ‘On-Device-Rendering’?*

### 3.2 Implementation of the Application

The application (Fig. 2) represents an implementation of an AR system for visualization of complex, spatial planning scenarios. The goal is an AR implementation approach for UP application that can be provided for a lean, SME-suitable process to masters the trade-off of sufficient detail and quality of immersive information (3D models and contextual annotations) with sufficient system robustness. Different native formats CAD, BIM or 3D models have to be manually processed as mesh-based, textured 3D models according to a defined asset pipeline. The models are uploaded in the mixed reality application at runtime via a web-based AR content management system. Due to the specified requirements, such as a low-budget solution, low complexity and independence of technology providers, the approach of cloud rendering was not preferred. The following approach was implemented:

To render the geometric information in the HMD hardware, the first step is to load a 3D model onto the client at runtime of the application. For this, an asynchronous



**Fig. 2.** System architecture of the implementation

HTTP request is sent to the webservice by an user input. This serves as an abstraction layer for the provision of the file-based data storage of the 3D models. After the file has been successfully downloaded, an asset template is created, which functions as a placeholder for the geometric information. This template provides the application logic for interactions, which remains the same for all instances, and provides the adjustments to the visualization of the exchangeable geometric data. The loaded mesh and the respective textures are inserted into this placeholder and stored on the device for later instantiations. Afterwards, a concrete instance of the complete asset (e.g. 3D model of the UP planning scene) is created and added with meta information, including an optional scaling factor, an asset name and a dynamically generated instance ID. This information is listed via user interface for the identification of all instances loaded in the scene. Subsequently, the animation data optionally available in the loaded file is converted into animation objects and an animation dialogue is made available to them on the user interface. Finally, the instance is inserted as a node in the scene graph of the 3D engine and is located relative to the real environment using a spatial anchor.

## 4 Methodology

To explore the overall system capability (performance) of the aforementioned implementation, the following DOE is developed:

### 4.1 Design of Experiment (DOE)

The objective of the experiment is to examine the maximum number of 3D models considering predefined Level of Detail (LoD) in the industrial context. The number of simultaneously rendered 3D models and the LoD are defined as independent variables. As dependent variable the system stability is evaluated. Starting from zero, the number

of 3D models is continuously increased. Four different LoD are defined by manipulating the number of polygons and resolution of the mono-texture (Table 1). As an indirect metric, the polygon density in the unit polygons/m<sup>3</sup> was derived (Eq. 1) [18]:

$$\text{polygonal density} = \frac{\text{total polygone count}}{\text{augmented volume}} \quad (1)$$

The LoD is selected based on prior experience in the industrial context and the subjective quality assessment depending on the available model for the experiment. Starting from a high-quality model by the asset pipeline, the number of polygons and the texture resolution are successively reduced in percentage. The structural complexity of the object hierarchy is reduced to a singular level.

**Table 1.** Predefined LoD as function of number of polygons, density and texture

level of detail [%]	number of polygons	polygone density [polygons/m <sup>3</sup> ]	texture resolution [MP]
100	107,000	3,922	1.05
50	53,600	1,963	0.52
35	37,500	1,374	0.37
10	10,700	392	0.11

To ensure the system stability, the displayable frames per seconds (FPS) are validated against the threshold 20 FPS by the system performance dialogue (current RAM load and FPS). Above 20 FPS, the usability of the system is assumed. According to the manufacturer's specifications of MS HoloLens 2, the system performance is affected by several influencing factors on 3D models [19]. Thus, the following parameters are defined to the 3D models: hidden and unused data are removed, drawing calls are reduced, inverted surface normals are reversed and conflicting tangent bases are solved.

## 4.2 Experimental Setup

The experiment is realised in a de-cored building (previously used for industrial purposes) on the first floor (cf. Fig. 3). The dimensions of the vacant area are 41.58 m in length and 31.60 m in width, which represents a total area of 1,314 m<sup>2</sup>. The available room height is about 3.05 m. In total, the room offers a volume of 4,007.48 m<sup>3</sup>. The 3D model represents a CNC milling machine (Index GFG 250). The test is conducted on a Microsoft HoloLens 2 (Windows Holographic V21H2, Build 20348-1432). The application was developed in Unity (Ver. 2021.1.9). For each LoD, a series of experiments is performed in which the number of rendered models is increased cyclically. After each additional model, the system stability (functionality) of the application is validated. The test ends with the performance-related crash of the application or dropping below the threshold of 20 FPS.



**Fig. 3.** Immersive screenshot of the experiment with the rendered 3D models

## 5 Results

Twelve 3D models (corresponding to an immersive volume of  $327.38 \text{ m}^3$ ) of the LoD-100% in a total of 1.284 million polygons can be rendered stably. With the LoD-50%, 35 3D models in a total of 1.876 million polygons (corresponding to an immersive volume of  $954.70 \text{ m}^3$ ) can be reliably displayed. By the LoD-35%, 70 instances in a total of 2.625 million polygons and an immersive volume of  $1,909.09 \text{ m}^3$  can be resiliently depicted. The resulting number of 3D models by LoD-10% can not be determined in the given setting due to the lack of available space. The results suggest that the maximum total count of 3D models does not only dependent on the number of polygons, but also on the polygonal density, among other things.

## 6 Discussion

One of the paradigms of sustainable software engineering is the ‘limitations imposed by the state of technology (...) on the environment’s ability (...) to meet present and future needs’ [7]. This recurs to the comparison of the study result to the specification of the hardware, in that the present implementation exceeds the number of reliably representable polygons by a factor of 8 compared to the reference implementation (‘low-scene complexity’, three models à 100,000 polygons) [20]. The direct effects on the software footprint, such as the energy consumption of the system can not be considered [6]. However, the implementation serves sustainability, as larger scenes can be mapped via On-Device-Rendering without relying on the resource-intensive cloud rendering. Basically, the AR system can be used for the rendering of large scale industry scenarios to support UP (planning). According to the rebound effect, a robust application leads to a positive user experience [6]. In this case the software contributes to effective UP concepts, due

to its resilience. Especially towards the UP purpose, an immersive application supports users of different skill levels and roles in a sustainable way [7]. By providing relevant information at the place of fulfilment [8], avoidable misinterpretations in the evaluation and development of UP concepts can be reduced in early planning stages and communication barriers can be lowered between the stakeholders. Furthermore, it becomes apparent that the effective performance depends, among other things, on the build of the operating system in the industrial metaverse. In most cases, the approach is not standardized and is therefore described as precisely as possible in the interest of reproducibility. Further research with to be developed, standardized methods is recommended.

## 7 Conclusion

With the presented results, the research question can be answered precisely. If a comparable AR system such as the introduced approach is to be used in an UP planning task, analogous study results can facilitate the right choice of the LoD and the evaluation of a priori capabilities in order to ensure the successful application in terms of system stability. The presented solution as an immersive tool of the ‘Ultra-Efficiency Approach’ [16] can strengthen the technical UP methods with sufficient rendering performance. Thus, such a software system can be used sustainably and offers technological approaches towards the design of a powerful industrial metaverse. For further investigation of the technical sustainability, it is necessary to investigate the influencing factors and effects of specific industrial applications in terms of effectiveness, efforts, acceptance and other stimuli of human-machine interactions.

**Acknowledgements.** The authors gratefully acknowledge the support by the state of Bavaria. The Bavarian Ministry of Economic Affairs, Energy and Technology funds this Bavarian Alliance Research Program (BayVFP)-project (Grant no. DIK0113/01, IUK-1811-0022).

## References

1. Ghobakhloo, M.: Industry 4.0, digitization, and opportunities for sustainability. *J. Clean. Product.* **252**, 119869 (2020)
2. Ejsmont, K., Gladysz, B., Kluczek, A.: Impact of industry 4.0 on sustainability—bibliometric literature review. *Sustainability* **12**(14), 5650 (2020)
3. Arena, M., Ciceri, N.D., Terzi, S., Bengo, I., Azzone, G., Garetti, M.: A state-of-the-art of industrial sustainability: definitions, tools and metrics. *Int. J. Prod. Lifecycle Manage.* **4**(1–3), 207–251 (2009)
4. Juraschek, M.: *Analysis and Development of Sustainable Urban Production Systems*. Springer (2022)
5. Lentens, J.: *Urbane Produktion*. In: *Neue Entwicklungen in der Unternehmensorganisation*, pp. 45–55. Springer Vieweg, Berlin, Heidelberg (2017)
6. Amsel, N., Ibrahim, Z., Malik, A., Tomlinson, B.: Toward sustainable software engineering: NIER track. In: 2011 33rd International Conference on Software Engineering (ICSE), pp. 976–979. IEEE (2011)

7. Johann, T., Dick, M., Kern, E., Naumann, S.: Sustainable development, sustainable software, and sustainable software engineering: an integrated approach. In: 2011 International Symposium on Humanities, Science and Engineering Research, pp. 34–39. IEEE (2011)
8. Betz, S., Caporale, T.: Sustainable software system engineering. In: 2014 IEEE Fourth International Conference on Big Data and Cloud Computing, pp. 612–619. IEEE (2014)
9. Matt, D.T., Orzes, G., Rauch, E., Dallasega, P.: Urban production—a socially sustainable factory concept to overcome shortcomings of qualified workers in smart SMEs. *Comput. Ind. Eng.* **139**, 105384 (2020)
10. Ramsebner, J., Haas, R., Ajanovic, A., Wietschel, M.: The sector coupling concept: a critical review. *Wiley Interdiscipl. Rev. Energy Environ.* **10**(4) (2021)
11. Burggräf, P., Dannapfel, M., Uelpenich, J.: Sustainability of factories in urban surroundings enabled by a space efficiency approach. In: Andersen, A.-L., et al. (eds.) *CARV/MCPC -2021*. LNME, pp. 987–996. Springer, Cham (2022). [https://doi.org/10.1007/978-3-030-90700-6\\_113](https://doi.org/10.1007/978-3-030-90700-6_113)
12. Sajadieh, S.M.M., Son, Y.H., Noh, S.D.: A conceptual definition and future directions of urban smart factory for sustainable manufacturing. *Sustainability* **14**(3), 1221 (2022)
13. Reuter, C.; Prote, J.-P.: Standortentscheidungen systematisch herleiten, *ZWF Online*, Jahrg. 110 (2015) 10, Carl Hanser Verlag, München (2015)
14. Herr, D., Reinhardt, J., Reina, G., Krüger, R., Ferrari, R.V., Ertl, T.: Immersive modular factory layout planning using augmented reality. *Procedia CIRP* **72**, 1112–1117 (2018)
15. Tan, C.H., Yap, H.J., Musa, S.N., Chang, S.W., Sivadas, C.S., Hisaburi, A.S., Baharudin, L.H.: Augmented reality assisted facility layout digitization and planning. *J. Mech. Sci. Technol.* **35**(9), 4115–4123 (2021)
16. Hertwig, M., Bogdanov, I., Beckett, M., Waltersmann, L., Lentjes, J.: Symbiotic loss-free industrial production in ultra-efficient urban industrial parks. *Procedia CIRP* **98**, 637–642 (2021)
17. Qiao, X., Ren, P., Dustdar, S., Liu, L., Ma, H., Chen, J.: Web AR: a promising future for mobile augmented reality—state of the art, challenges, and insights. *Proc. IEEE* **107**(4), 651–666 (2019)
18. <https://docs.microsoft.com/en-us/windows/mixed-reality/design/spatial-mapping>. Accessed 4 May 2022
19. <https://docs.microsoft.com/en-us/dynamics365/mixed-reality/guides/3d-content-guidelines/best-practices>. Accessed 4 May 2022
20. <https://docs.microsoft.com/en-us/dynamics365/mixed-reality/guides/3d-content-guidelines/optimize-models>. Accessed 4 May 2022

**Open Access** This chapter is licensed under the terms of the Creative Commons Attribution 4.0 International License (<http://creativecommons.org/licenses/by/4.0/>), which permits use, sharing, adaptation, distribution and reproduction in any medium or format, as long as you give appropriate credit to the original author(s) and the source, provide a link to the Creative Commons license and indicate if changes were made.

The images or other third party material in this chapter are included in the chapter’s Creative Commons license, unless indicated otherwise in a credit line to the material. If material is not included in the chapter’s Creative Commons license and your intended use is not permitted by statutory regulation or exceeds the permitted use, you will need to obtain permission directly from the copyright holder.







# Development of a Potential Analysis for the Introduction of Sustainable Digitization Solutions

Tanja Steinbach<sup>1</sup>✉, Franziska Parthey<sup>1</sup>, Markus Weidmann<sup>2</sup>, and Reiner Anderl<sup>1</sup>

<sup>1</sup> Department of Computer Integrated Design (DiK), TU Darmstadt, Otto-Berndt-Straße 2,  
64287 Darmstadt, Germany  
steinbach@dik.tu-darmstadt.de

<sup>2</sup> Inventied GmbH, Albrecht-Dürer-Ring 22B, 67227 Frankenthal, Germany

**Abstract.** This paper presents a methodical approach that addresses the challenges of the development process to ensure sustainable product use. Consideration of user behavior in the use phase of products is imperative for efficient support by the technical system already in the development phase.

For these and other challenges, the developed approach combines methods of system engineering with the human-technology-organization approach. It helps to identify and develop optimization potential in the area of digitization solutions in the early phases of the product lifecycle. To do this, a technical system is analyzed in its current state and the requirements of the stakeholders. By defining socio-technical system elements and applying a structured approach, recommendations can be outlined holistically. As a result, the recommendations lead to an increasing level of digitization of the technical system and ensure a targeted development process.

Furthermore, the methodical approach includes modeling methods to deal with the complex system behavior. The modeling language SysML as well as task-related analysis methods are used to highlight faulty states and promising aspects. In addition to the human-technology-organization triad, the basis of the developed approach is the V-model, which is applied in phase-oriented design processes or iterative design steps. This makes the usage of the approach particularly advantageous for interdisciplinary development teams.

**Keywords:** systems engineering · socio-technical systems · digitalization · potential analysis

## 1 Introduction

The topic of sustainability has become increasingly important in recent years. The findings of science and research show that, especially in industry, considering sustainability aspects is indispensable. In order to take the important sustainability aspects into account in the early stages of product development, the entire product life cycle must be considered and examined for potential to obtain a sustainable product.

A particular challenge is to assess the role and behavior of people as users of a product. On one side, the users' behavior is highly relevant for the sustainable utilization of products; on the other side, developers need to assure sustainable products and operability. Therefore, much research focuses on requirement management to guarantee targeted and holistic development work and decisions. Especially digitalization solutions or so-called cyber-physical systems have the potential for sustainable products and utilization if they are implemented deliberately and by deep system understanding. Challenging is a successful integration of cyber-physical systems in existing and complex organizational structures and processes.

This paper presents a methodical approach for examining existing physical processes for optimization potential with regard to digitization solutions. The aim is to identify optimization potential of the existing technical system for effective support of humans, to identify possible points of influence in processes, and to integrate digitization solutions into the so-called socio-technical system.

The methodical approach is based on system engineering (SE) methods in combination with the human-technology-organization (HTO) approach. SE refers to a problem-solving process. Therefore, problems need to be outlined and specified.

## 2 State of the Art

First, the HTO approach is briefly characterized by introducing socio-technical systems. In the following, SE is shortly outlined as well as the V model as the established model of development processes. Subsequently, SysML as a modeling language is introduced.

A socio-technical system is characterized by the coexistence of a technical and a social subsystem. The subsystems are connected by tasks. The human-technology-organization (HTO) approach according to Strohm and Ulich [1] is established in human factors science. The aim of the HTO approach is to improve processes in so-called socio-technical working systems holistically on several economic levels such as companies, organizational units, working groups, or individuals. Therefore human, technology, and organization are defined as system elements of the socio-technical system and influence each other as a consequence of the common task. The organization of the HTO approach is characterized by its structure, processes, and management structures. Humans have individual characteristics, such as health, competencies, or motivation. Technology can be characterized by its functionality, selection, or implementation. If one of the three elements is changed, this has an impact on the other elements. Defining tasks and functions of a planned system brings the network behavior into focus to hinder suboptimization. Plus, developers are encouraged to allocate functionality of the whole working system to humans or machines precisely. Mentioned analysis methods on behalf of the HTO approach are observations and written or oral interviews. [1].

SE mainly signifies an interdisciplinary approach to develop successful systems fulfilling the requirements of stakeholders. Therefore, the requirements are defined in the early stages of the development process to continue the process of system design and validation [2]. Furthermore, in the understanding of SE technical and economic aspects are mentioned, such as time, quality, testing, training, maintenance, operation, and disposal, to ensure a structured and reliable development process and result. In

general, a “system” in the SE context consists of system modules pursuing a common goal. System modules can be software, hardware, persons, or any other unit [3].

The V model is a generic procedure model in the SE context such as described in VDI/VDE 2206. It describes the case-by-case required development and hedging activities. The left branch of the V model leads to the specified system design. The right branch leads through the verification and validation of the implemented solutions and system requirements. Challenging in an interdisciplinary development team is to arrange the requirements of a complex system traceably. The V model is one established procedure model to visualize targeted development work in the context of cyber-physical systems [4].

Applying SE methods in order to analyze systems and processes of a system modeling languages such as SysML are functional. They help to guarantee a sufficient specified target system in the product development process. Therefore, diagrams such as requirement, activity, or use case diagrams are included in the repertory of SysML.

For technical systems methods such as Fault Tree Analysis (FTA) are established to extract the causes and effects of faulty states quantitatively and qualitatively [5]. Therefore, main events, which are faulty states, are analyzed by subsequent key events, which lead in combination to the main event. This technique can also be applied by defining success as the main event instead of a fault state [5].

There are various examples of successful applications of the HTO approach to analyze human-machine interaction in working or safety contexts in various domains. The derived aims of applying the HTO approach are to increase productivity, quality, and safety. Especially, the physiological and mental effects on humans are examined and the outcomes of the analysis are reused to improve the following technical systems. [6].

This addresses the sustainability aspects because suboptimization of socio-technical systems can be prevented by holistic development processes. Well-considered system improvements provide the potential to deal with exhaustible resources. Also, reasonably integrated digitization solutions may increase efficiency.

Still challenging is to integrate the human-machine interactions into the whole development process. Especially in interdisciplinary development teams, the agreement on a common development procedure and tool is rarely unified. Developing complex technical systems, model-based SE methods and the V model are commonly used [7]. This is because this paper presents a concept to combine human factor science and SE methods.

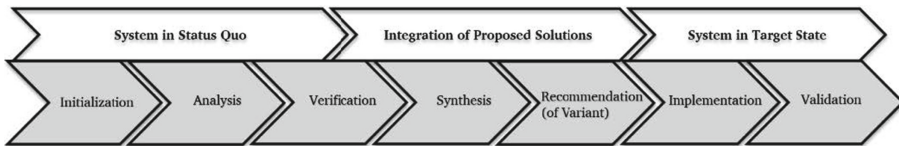
### 3 Concept

With the help of the developed methodical approach, a system with a higher degree of digitization in the target state is developed from stakeholder requirements and a system in the actual state. The developed approach is based on methods and models of SE in connection with the HTO approach. Therefore, the system elements *human*, *technology*, and *organization* as well as an inner and outer system boundary are defined. The methodical approach can be applied by going through the development phases *initialization*, *analysis*, *verification*, *synthesis*, *implementation* and *validation* chronologically (c.f. Fig. 1). Analogous to the V-model, the methodical approach can also be applied time-invariantly (c.f. Fig. 3). The detailed process of gaining optimization potential of the actual system

is explained by defining *tasks*. Optional, a deep analysis of the socio-technical system is done by applying SysML techniques and a so-called Success Tree Analysis (STA), captured from data collections.

### 3.1 Development Phases

At the beginning of the development work, stakeholder needs are discussed in the *initialization* phase (c.f. Fig. 1). The *analysis* phase includes the extensive investigation of the socio-technical system, including the modeling of use cases and processes. In the subsequent *verification* phase, the created system models are verified with the help of defined *tasks*. These first three phases deal with the system in the actual state which is to be improved (c.f. Fig. 1). By passing through the *analysis* and *verification* phase, faulty states and optimization potential are worked out, which are combined with digitization solutions in the subsequent *synthesis* phase. Until the *recommendation* phase, possible digital solutions are integrated as variants. From the *implementation* phase, the target system is focused. Therefore, one solution variant is selected and realized. Finally, compliance with the required stakeholder needs is determined in the *validation* phase. Figure 1 shows the development phases of the methodical approach. Like the V model proposes, there are phases of analysis and validation. In between, the methodical approach includes a verification phase of the modeled socio-technical system and its physical processes.



**Fig. 1.** Development phases of the methodical approach.

### 3.2 Defining System Elements and System Boundaries

A central component of the methodical approach is the definition of system elements: *humans*, *technology* and *organization*. An outer, extensive system boundary separates the HTO system elements from their environment. Figure 2 represents the defined HTO system elements. An outer, extensive system boundary includes the whole socio-technical system and places it into a specific environment and context. For SE techniques it is functional to use an inner system boundary to focus on the technical systems. Therefore, the impact of the other system elements *human* and *organization* have to be considered, too.

Another central component of the methodical approach is the integration of defined *tasks* into the socio-technical system. The considered *tasks* enable the verification of the created system models. The *tasks* are responsible for the interactions of the HTO system elements.

Examples of the definitions, system boundaries, and tasks are given in Sect. 4.

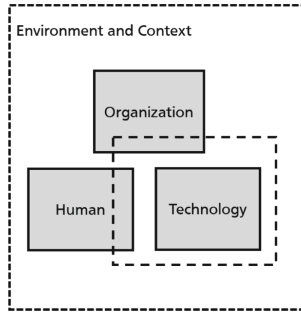


Fig. 2. System boundaries of the HTO system.

### 3.3 Detailed Methodical Approach to Gain Faulty States and Optimization Potential

Figure 3 exemplarily shows details of the methodical approach; starting by considering specific *tasks* of the HTO system. Modeled use cases and processes support analyzing the *tasks*. With the help of data collections with former types or prototypes of the technical system, the HTO system behavior can be observed. Based on this, faulty states and optimization potential are derived. Drafting system requirements during the whole development process is supported as well as considering possible system solutions and, finally, a recommendation of a solution variant, which includes digitization solutions.

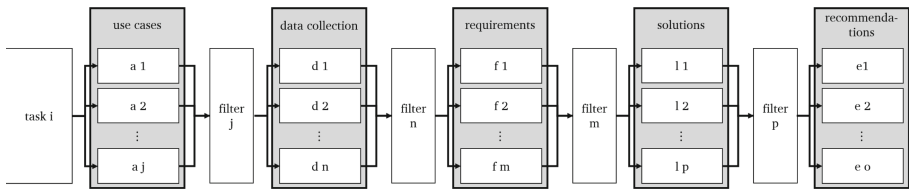


Fig. 3. Exemplary detailed concept.

For instance, *tasks* are usual or unusual user instructions and scenarios of the foreseen use phase of the product life cycle. Defining multiple *tasks* (c.f. index  $i$ , Fig. 3) will increase the reliability of the analysis results and are related to validation parameters (c.f. right side of the V-model [4]).

Modeling use cases, as well as system processes of the socio-technical system, is convenient for systematic and detailed analysis. In the *verification* phase (c.f. Fig. 1) the modeled system needs to be verified. Faults due to modeling need to be minimized because they affect the quality of the optimization potential and within this the development success. In Fig. 3 the variables  $a_1 \dots a_j$  symbolize verified use cases the socio-technical system has to deal with. In Fig. 3 the mentioned inaccuracies of modeling to be minimized are symbolized by filter  $j$ .

Furthermore, it is convenient to analyze the tasks of the socio-technical system within data collection methods such as field studies, interviews, observations and surveys. At

first, the data collection methods will hand out objective statements about the socio-technical system. In Fig. 3 the objective statements are symbolized by the variables  $d_1 \dots d_n$ . Secondly, existing faulty states and ideas of optimization potential can be derived. To build the base for the optimization potential an STA out of a qualitative FTA [5] is a systematic and traceable technique. Modeling a success tree, defining the *task* or parts of the *tasks* as a main event is functional and helps to derive optimization potential traceably. Despite this, the combination of causes and effects of a socio-technical system stays sensitive to errors. In Fig. 3 this combination work is symbolized by filter  $n$ .

Referring to the V model [4] requirements of the target system are pointed out after the *analysis* and *verification* phase (c.f. Fig. 1). Depending on the requirement management, wording, or level of detail, there is room for interpretation, which is symbolized with filter  $m$  in Fig. 3.

In the *synthesis* phase (c.f. Fig. 1), the system requirements and digitalization solutions are merged and become variants of solutions of the target system. Until this point of development, the solution variants for the target system stay unvalued. Even the system analysis can be a solution open until this phase. After weighting depending on the development goals a solution variant can be recommended. The weighting is symbolized in Fig. 3 by filter  $p$ . Development goals can be aspects of time, costs, quality, especially sustainability.

## 4 Validation

The concept presented in this paper is validated by applying it in a development project on the technical system Vario-Load-Rescue (VLR), which is invented by the startup “invented” and used in Technisches Hilfswerk (THW) contexts. “Invented” produces and develops devices for civil protection. The VLR is one of those with the aim to support rescue operations by THW. The VLR is a carrier, loaded with rescue items, and has currently a low digitalization degree. So, the socio-technical system was specified by THW as *organization*, THW workers and system developers as *humans*, and the VLR itself as *technology*. Also, the validation of the concept dealt with observing a THW operation simulation, where THW workers operated with the VLR in a realistic scenario and were charged with realistic *tasks*, such as building underpin constructions. The inner system boundary, to limit the SysML modeling effort, included the VLR, as well as its rescue items. The outer system boundary also included the THW workers and their working structure. For example, phone calls and shouts were noted and analyzed, to gain the relevant operation information. This enabled the developers to analyze the communication and operational strategy of the THW workers and to differentiate the potential of organizational or technological nature. The SysML modeling included use cases of the VLR and the activities observed in the THW operation simulation. Through should and actual comparison in the operation simulation, fault states and time-intensive activities were outlined. Based on this, the observations were noted and worded as requirements for system improvement. Existing digital solutions, such as digital inventory or the visualization of underpinning constructions, were integrated into the modeled processes and finally recommended.

The aim of the development work was to increase the digitalization degree of the VLR to maximize its potential to support rescue operations, especially in time-critical

situations. Characteristic weighting aspects also focused on robustness and availability (c.f. Fig. 3, filter p). This validation case is exemplarily for treating socio-technical systems to increase the efficiency of processes through digitalization solutions.

## 5 Conclusions

In this paper, a methodical approach was presented to identify potentials for possible digitization solutions in an existing socio-technical system, and then to develop and integrate corresponding digitization solutions in a guided manner. The development of the approach is based on the combination of engineering and occupational science methods. Thus, the approach is also applicable in the context of established development models, such as VDI/VDE 2206. Furthermore, the approach uses the established human-technology-organization approach. By defining the system elements organization and human, the structures in which the product is used become more visible. This has the advantage that the user behavior of products becomes more transparent.

In the context of a cooperation project, the presented approach could already be tested successfully. It could be validated that it is suitable to analyze a socio-technical system where the user behavior has a great influence on the technical system and its support potential. The approach guided through the development phases and enabled interdisciplinary development work as well as the outlining of constructive requirements for a target system with a higher degree of digitization.

The concept provides a guideline for implementing digitization solutions consciously and on the basis of objective considerations. The naming of filters and points of influence in the development process ensures transparency and traceability. The use of defined HTO system elements and tasks clarifies the relevance of the individual parts of a system. The creation of system models and links that visualize system-promoting or system-inhibiting effects help to outline the optimization potential and to implement solutions in a targeted and holistic manner.

The division of tasks into primary and secondary tasks ensures aspects of functionality in the development, but also creates room for the consideration of aspects of sustainability, such as maintenance or disposal activities. On the one hand, this opens up broader thinking about possible applications for the product. On the other hand, relevant sustainability aspects are thus systematically included in the early development phases.

The digitization solutions that are developed and introduced with the help of the present approach are an efficient alternative to or support for existing solutions. In addition, the focus of the developed methodology can be placed purely on the area of sustainability, so that mainly or exclusively optimization potentials with regard to sustainability are identified and corresponding solutions are implemented.

**Acknowledgments.** This research and development project is funded by the German Federal Ministry of Education and Research (BMBF) within the Innovations for “Tomorrow’s Production, Services, and Work” Program (02J19B012, CyberTech) and implemented by the Project Management Agency Karlsruhe (PTKA). The author is responsible for the content of this publication.

The development and validation of the results were supported by Inventied GmbH. Thanks to all participants involved, in particular to the staff of THW Frankenthal.

## References

1. Strohm, O., Ulich, E.: Unternehmen arbeitspsychologisch bewerten: Ein Mehr-Ebenen-Ansatz unter besonderer Berücksichtigung von Mensch, Technik und Organisation, pp. 9–10, 265–266. vdf Hochschulverlag AG an der ETH Zürich, Zürich (1997)
2. Endler, D., Geisreiter M., Rambo, J.: Systems Engineering Handbuch: Ein Leitfaden für Systemlebenszyklus-Prozesse und -Aktivitäten. INCOSE (International Council on Systems Engineering), deutsche Übersetzung der 4. Auflage, pp 15–16. GfSE e.V. (2017)
3. Weikiens, T.: Systems Engineering mit SysML/UML: Anforderungen, Analyse, Architektur. 3, überarbeitete und aktualisierte Auflage, p. 72. dpunkt Verlag Heidelberg (2014)
4. Verein Deutscher Ingenieure/Verband der Elektrotechnik Elektronik Informationstechnik: VDI/VDE 2206: Entwicklung mechatronischer und cyber-physischer Systeme, Beuth Verlag GmbH, Berlin (2021)
5. Deutsches Institut für Normung e.V.: DIN EN 61025: Fehlzustandsbaumanalyse (IEC 61025:2006); Deutsche Fassung EN 61025:2007. Beuth Verlag GmbH, Berlin (2007)
6. Berglund, M., Karlton, A., Eklund, J., Karlton, J.: HTO – A Concept of Humans, Technology and Organisation in Interaction, p. 2, HELIX working papers 20:002, LiU-Tryck, Linköping (2020)
7. Eigner, M., Roubanov, D., Zafirov, R. (eds.): Springer, Heidelberg (2014). <https://doi.org/10.1007/978-3-662-43816-9>

**Open Access** This chapter is licensed under the terms of the Creative Commons Attribution 4.0 International License (<http://creativecommons.org/licenses/by/4.0/>), which permits use, sharing, adaptation, distribution and reproduction in any medium or format, as long as you give appropriate credit to the original author(s) and the source, provide a link to the Creative Commons license and indicate if changes were made.


The images or other third party material in this chapter are included in the chapter's Creative Commons license, unless indicated otherwise in a credit line to the material. If material is not included in the chapter's Creative Commons license and your intended use is not permitted by statutory regulation or exceeds the permitted use, you will need to obtain permission directly from the copyright holder.







# Industrial Digital Twin in Industry 4.0: Enabling Service Exchange Between Assets in Manufacturing Systems

Tim van Erp<sup>(✉)</sup> , Frederik Bredahl Pedersen, Niels Peter Lamm Larsen, and Rasmus Bæk Lund

Department of Technology and Innovation, University of Southern Denmark, Campusvej 55,  
5230 Odense, Denmark  
tve@iti.sdu.dk

**Abstract.** The idea of the Asset Administration Shell (AAS) is currently evolving into a framework for the Industrial Digital Twin in Industry 4.0 since more and more industrial use cases for its application as well as AAS sub-models with standardized semantic properties are being defined. The concept of the AAS enables data interoperability and thus provides novel opportunities for exchanging services between manufacturing assets, digital platforms, and value chain actors. Services in this sense are fabrication or assembly operations and tasks. It is demonstrated, how the data link and exchange between different AASs on the equipment level can be accomplished through an overlaying AAS on the manufacturing system level. A conceptual model for the service exchange is developed based on the state-of-the-art within the field of Industry 4.0. The model is subsequently verified and validated through a case implementation at the University of Southern Denmark's Industry 4.0 lab.

**Keywords:** Industry 4.0 · Industrial Digital Twin and Asset Administration Shell · Service exchange

## 1 Introduction

### 1.1 Rationale

Industry 4.0 (I4.0) embraces the fusion of the physical with the virtual world while facilitating the automation of industrial value creation [1]. An important building block of I4.0 is to establish interoperability between manufacturing assets in complex global value networks [2, 3]. The realization of interoperability usually requires industry standards and their integration throughout different hierarchy levels of manufacturing systems. For this purpose, the standardized Asset Administration Shell (AAS) comes into play as the Industrial Digital Twin in I4.0. The development of a concept for exchanging digital services between manufacturing assets by utilizing the AAS's functionalities seems particularly relevant for the future application of the AAS in manufacturing systems. Manufacturing equipment must be enabled to exchange services with other equipment or products. This will allow to automatically and decentralized match the required manufacturing process steps to manufacture a certain product [4].

© The Author(s) 2023

H. Kohl et al. (Eds.): GCSM 2022, LNME, pp. 567–575, 2023.

[https://doi.org/10.1007/978-3-031-28839-5\\_64](https://doi.org/10.1007/978-3-031-28839-5_64)

## 1.2 Research Approach

The paper addresses a deductive, qualitative research approach, which demonstrates the results of ongoing I4.0 research at the University of Southern Denmark (SDU). In Sect. 2, a brief overview of the state-of-the-art based on a semi-structured literature review in the context of the AAS is elaborated. In Sect. 3, a conceptual model for exchanging services between assets based on the AAS is presented. In Sect. 4, a proof-of-concept demonstrates how the data link between a 3D printer and an Autonomous Mobile Robot (AMR), to enable service exchange, can be accomplished by using the AASX Package Explorer software. In Sect. 5, the research is summarized and an outlook for future research activities is given.

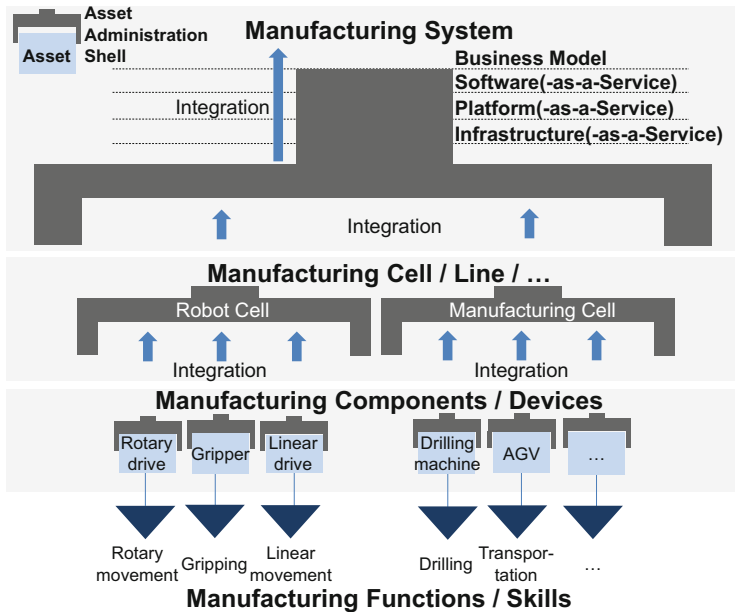
## 2 State-of-the-Art

### 2.1 Asset Administration Shell (AAS)

The application of the AAS in manufacturing systems is proposed by different industry associations as the key to achieving interoperability in I4.0 manufacturing systems [5–7]. The EU-based Industrial Digital Twin Association and the US-based Digital Twin Consortium just decided to collaboratively develop the AAS technology in the future by standardizing requirements and through discussions for harmonizing the technological standard [8]. The AAS aims at storing and collecting relevant data and data streams, such as technical data, operational data, identification data, etc., over the whole life cycle of an asset [9]. The data is clustered according to specific sub-models of the AAS (Table 1). The sub-models are defined by standardized semantic properties and contain sub-model elements e.g., functions, properties, and processes, which eventually determine the digital representation of the asset [10]. Industry-driven initiatives are contributing to coining the AAS standard [11]. For example, an industry-driven research project investigated and demonstrated how AAS technology can be used to digitalize the nameplate of products [12]. Current academic projects explore how the AAS can be designed and integrated into manufacturing systems [13]. Figure 1 gives an idea for integrating AASs throughout different hierarchy levels of manufacturing systems.

**Table 1.** Example of sub-models of the AAS [14].

Sub-model	Content
Nameplate	Defines the digital nameplate of the asset
Identification	Defines the supplier and product
TechnicalData	Defines and contains the technical data of a product
ConfigurationalData	Defines the setup parameters of a production process
OperationalData	Defines and contains the actual values of a production process
Documentation	Stores documentation for the product and/or process
CertificatesAndDeclaration	Storing certificates and conformance classes



**Fig. 1.** Integration of AASs on different hierarchy levels of manufacturing systems [1]

## 2.2 Service Exchange Between Assets

Technically, the exchange of information between assets can be defined as a minimum requirement for a service exchange [15]. For example, an AAS on the system level might request the process status of a physical asset on the equipment level, which then will provide the status by a boolean signal based on classifications of the data under the given property. In an AAS context, a service exchange is executed as a service request by one AAS and the response from another AAS within the manufacturing system. This automatic service exchange is utilized by connecting AASs using unique semantic IDs. These IDs provide an unambiguous identifier (or address/asset ID) for an AAS integrated into a network [12] and allow the implementation of self-managed assets. A self-managed asset is defined as an asset with its own semantic asset ID [14]. A foundation for exchanging services between manufacturing assets has been laid out by [16].

## 2.3 Research Gap and Objective

The academic and industry responses to the integration of AASs throughout manufacturing systems and the realization of service exchange between AASs are only beginning to take shape, see for example [1, 13, 16, 17]. A concept of how to link a system of different AASs to exchange services has not been sufficiently addressed in current industrial and academic work. The authors aim to contribute with their research to this discussion by

demonstrating an approach for the realization of service exchange between manufacturing equipment based on integrated AASs. However, the research presented by the authors focuses more on the practitioner’s perspective on AASs.

Thus, the developed concept is intended to inspire manufacturing companies to realize a service exchange between assets.

### 3 Concept

The concept is created by facilitating expert opinion. This means that the conceptual model is iteratively developed and evaluated until a consensus was reached among the authors. Further, the concept incorporates the current state-of-the-art in the field of AAS. It is based on the sub-model concept of the AAS [10, 14] as well as on the so-called Reference Models of I4.0 components [11]. A requirement for linking AASs is that every AAS and sub-model must consist of its unique semantic ID within the network [18]. The concrete connection of AASs can be realized by linking the underlying AAS sub-models e.g., on the component or equipment level of an asset, to a concrete sub-model on the system level. The conceptual model for linking the AAS to achieve a service exchange between self-managed assets is depicted in Fig. 2.

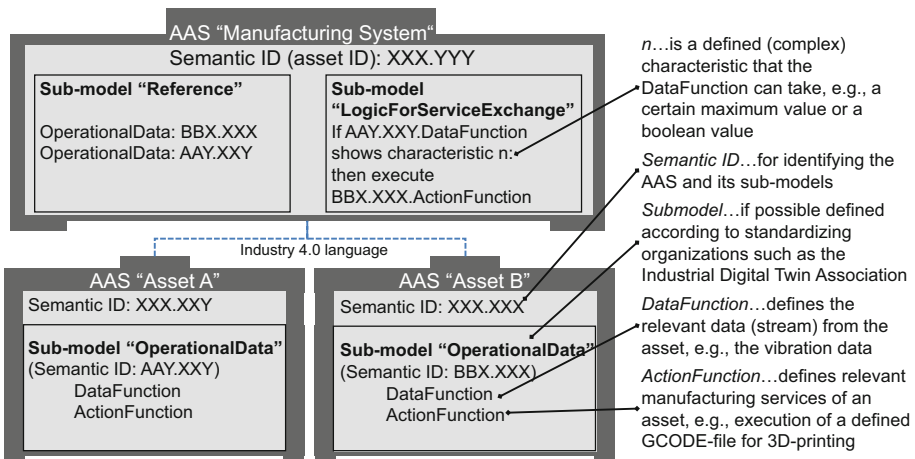


Fig. 2. Conceptual model for exchanging services using the sub-model reference

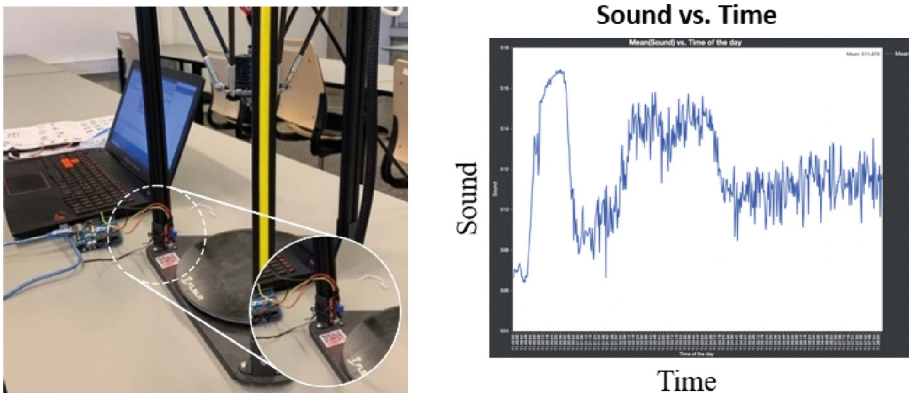
### 4 Proof-of-Concept

#### 4.1 Case

The proof-of-concept aims at verifying and validating the conceptual model from Sect. 3. It covers a case for service exchange between a 3D printer and an Autonomous Mobile Robot (AMR) in SDU’s Industry 4.0 lab. The two assets are selected due to their relevance

for Industry 4.0 manufacturing systems: 3D printers and AMRs are commonly used assets and thus provide a suitable and transferable case for exemplarily demonstrating the service exchange. Also, both assets are easily accessible in SDU's Industry 4.0 lab. Both assets, the 3D printer and the AMR represent self-managed assets with their AASs.

An Arduino sound sensor is used to collect the vibration data of the 3D printer (Fig. 3a). This data allows deriving the operational state of the printer e.g., start, printing, or idling state. Collecting the vibration data using a sound sensor is suitable for the proof of concept. However, with an industrialized 3D printer, the operational state can often be collected directly from the asset without attaching additional sensors. The Arduino sensor is collecting analog data input which is saved in a local database. Typically, this data would be stored in a cloud database, from where the AAS can collect the information. Small statistical data analysis was performed in JMP 15 to demonstrate that the collected data can be used to derive the different operational states of the 3D printer as shown in Fig. 3b.



**Fig. 3.** (a) Printer-sensor setup; (b) Measured vibration (sound) data stream over time.

The proof-of-concept setup is coined by the development of the AAS in the AASX Package Explorer software (AASX-PE), which is an open-source C# based editor [19]. The pre-defined sub-models from Table 1 have been implemented in the AAS on the equipment level. The sub-models on the system level have been selected based on [17]. A local database is hosting each AAS separately. The real-time linkage between AASs has not been fully implemented since the purpose of the implementation is to establish a sufficient conceptual demonstration of the service exchange. The linkage between the AASs is made by linking the semantic IDs from the AAS or relevant sub-model. The semantic IDs used are Internationalized Resource Identifier (IRI) links, but they could also be implemented by IRDI, FragmentID, ShortID, or custom ID depending on the use cases [19]. The IRI is named “<https://example.com>” and “[https://companyX\(orY\).com](https://companyX(orY).com)”, to illustrate that the IRI is a unique worldwide link. Hence, it fosters interoperability since it can be used across companies. In Fig. 4, a linkage using the sub-model reference, by following the model from Fig. 2, is demonstrated. The unique semantic ID of the “OperationalData” sub-model from the 3D printer (“FLSUN3Dprinter”)

has been directly linked to the “Printing” sub-model of the manufacturing cell’s AAS. Also, the operational data of the AMR (OperationalDATAMIR100) has been linked to the sub-model “Transportation” of the manufacturing cell. As a result, a logic for service exchange can be implemented as an additional sub-model. For example, within the “MESConnection” sub-model on the manufacturing cell level, the “PredictiveMaintenance” sub-model could now utilize the operational data from the AMR and the 3D printer to predict maintenance activities. Another example could be the implementation of a logic for scheduling the transportation tasks of the AMR, based on the operational data of the 3D printer: the ARM can be called automatically by the 3D printer for picking up the finished product.

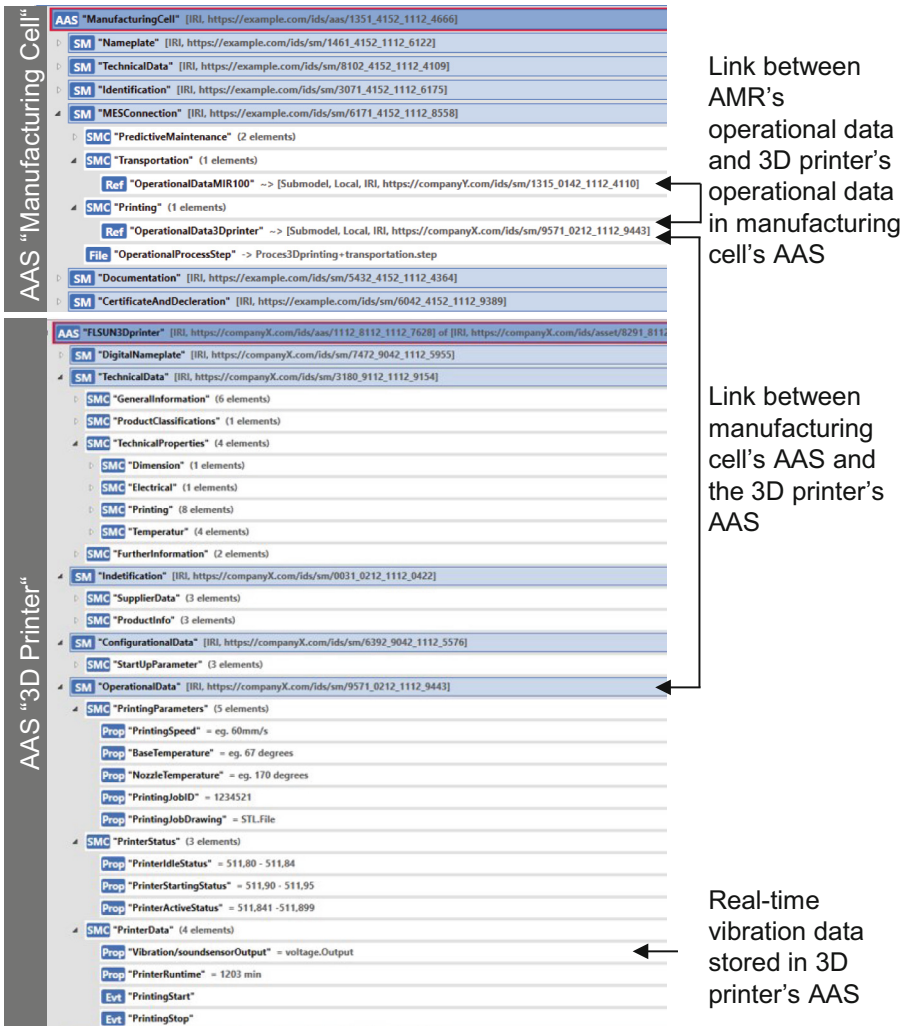


Fig. 4. Linking AASs on different manufacturing system levels using AASX-PE

## 4.2 Discussion and Limitations

The proposed conceptual model for exchanging services between manufacturing assets seems to be suitable for the available AAS technology and its open-source development tools. The functionality for exchanging service requests, i.e., manufacturing tasks, has been verified. The implementation of the logic for the service exchange was not part of the proof-of-concept and will be subject to future research. Only limited conclusions can be drawn in terms of the efficacy of the concept and its suitability for industrial application under real manufacturing conditions. Realizing a service exchange with the AAS technology might also be a future emphasis of the Industrial Digital Twin Association or other industry stakeholders. These actors might decide to realize the service exchange by using a different concept. However, the authors believe that the presented conceptual model demonstrates an initial idea of how the exchange of services can be implemented with the current state of standardized AAS technology.

## 5 Summary and Outlook

The research presented a conceptual model as well as a proof-of-concept for exchanging digital services within a system of Industrial Digital Twins based on the AAS technology. The service exchange is realized by integrating unique semantic IDs of AASs from manufacturing equipment into the AAS on the manufacturing system level and by defining a logic for the service exchange within the AAS of the manufacturing system. A proof-of-concept validated the basic functionality of the concept for exchanging services between two manufacturing assets. Future research will investigate the logic of service exchange within manufacturing systems. For example, it will be explored how a job shop scheduling approach can be implemented based on the AAS and the described service exchange concept.

## References

1. van Erp, T., Rytter, N.G.M., Sieckmann, F., Larsen, M.B., Blichfeldt, H., Kohl, H.: Management, design, and implementation of innovation projects: towards a framework for improving the level of automation and digitalization in manufacturing systems. In: 9th International Conference on Control, Mechatronics and Automation (ICCA), pp. 211–217 (2021)
2. Plattform Industrie 4.0. 2030 Vision for Industrie 4.0: Shaping Digital Ecosystems Globally. Plattform Industrie 4.0. (2019). [https://www.plattform-i40.de/IP/Redaktion/EN/Downloads/Publikation/Vision-2030-for-Industrie-4.0.pdf?\\_\\_blob=publicationFile&v=9](https://www.plattform-i40.de/IP/Redaktion/EN/Downloads/Publikation/Vision-2030-for-Industrie-4.0.pdf?__blob=publicationFile&v=9). Accessed 22 July 2022
3. Boss, B., Malakuti, S., Lin, S., Usländer, T., Clauer, E., Hoffmeister, M., et al.: Digital Twin and Asset Administration Shell concepts and application in the industrial internet and Industrie 4.0. Plattform Industrie 4.0 (2020). [https://www.plattform-i40.de/IP/Redaktion/EN/Downloads/Publikation/Digital-Twin-and-Asset-Administration-Shell-Concepts.pdf?\\_\\_blob=publicationFile&v=9](https://www.plattform-i40.de/IP/Redaktion/EN/Downloads/Publikation/Digital-Twin-and-Asset-Administration-Shell-Concepts.pdf?__blob=publicationFile&v=9). Accessed 22 July 2022
4. Plattform Industrie 4.0. Describing Capabilities of Industrie 4.0 Components. Plattform Industrie 4.0 (2020). [https://www.plattform-i40.de/IP/Redaktion/EN/Downloads/Publikation/Capabilities\\_Industrie40\\_Components.pdf?\\_\\_blob=publicationFile&v=2](https://www.plattform-i40.de/IP/Redaktion/EN/Downloads/Publikation/Capabilities_Industrie40_Components.pdf?__blob=publicationFile&v=2). Accessed 22 July 2022

5. Plattform Industrie 4.0. Details of the Administration Shell - From idea to implementation. Plattform Industrie 4.0 (2019). [https://www.plattform-i40.de/IP/Redaktion/EN/Downloads/Publikation/vws-in-detail-presentation.pdf?\\_\\_blob=publicationFile&v=12](https://www.plattform-i40.de/IP/Redaktion/EN/Downloads/Publikation/vws-in-detail-presentation.pdf?__blob=publicationFile&v=12). Accessed 22 July 2022
6. Industrial Digital Twin Association. Industrial Digital Twin Association – the Digital Twin, the future of industry. <https://industrialdigitaltwin.org/en/>. Accessed 22 July 2022
7. Digital Twin Consortium. Digital Twin Consortium. <https://www.digitaltwinconsortium.org/>. Accessed 22 July 2022
8. GlobeNewswire. Digital Twin Consortium Announces Liaison with the Industrial Digital Twin Association, 11 June 2022. <https://www.globenewswire.com/news-release/2021/12/02/2345129/0/en/Digital-Twin-Consortium-Announces-Liaison-with-the-Industrial-Digital-Twin-Association.html>. Accessed 10 May 2021
9. Industrial Digital Twin Association. Factsheet AAS-based Pilot Plant - Covering the entire production life cycle (2021). [https://industrialdigitaltwin.org/en/wp-content/uploads/sites/2/2021/11/21-10-18\\_IDTA\\_UseCases\\_FactSheet\\_PilotPlantProject-in-Korea\\_en.pdf](https://industrialdigitaltwin.org/en/wp-content/uploads/sites/2/2021/11/21-10-18_IDTA_UseCases_FactSheet_PilotPlantProject-in-Korea_en.pdf). Accessed 22 July 2022
10. Bader, S., Bedenbender, H., Billmann, M., Boss, B., Erler, S., Garrels, K., et al.: SPECIFICATION Submodel Templates of the Asset Administration Shell. Plattform Industrie 4.0, ZVEI (2020). [https://www.plattform-i40.de/IP/Redaktion/EN/Downloads/Publikation/Submodel\\_templates-Asset\\_Administration\\_Shell-Technical\\_Data.pdf?\\_\\_blob=publicationFile&v=3](https://www.plattform-i40.de/IP/Redaktion/EN/Downloads/Publikation/Submodel_templates-Asset_Administration_Shell-Technical_Data.pdf?__blob=publicationFile&v=3). Accessed 22 July 2022
11. Bedenbender, H., Billmann, M., Epple, U., Hadlich, T., Hankel, M., Heidel, R., et al.: Examples of the Asset Administration Shell for Industrie 4.0 components – Basic part. ZVEI (2017). [https://www.zvei.org/fileadmin/user\\_upload/Presse\\_und\\_Medien/Publikationen/2017/April/Asset\\_Administration\\_Shell/ZVEI\\_WP\\_Verwaltungschale\\_Englisch\\_Download\\_03.04.17.pdf](https://www.zvei.org/fileadmin/user_upload/Presse_und_Medien/Publikationen/2017/April/Asset_Administration_Shell/ZVEI_WP_Verwaltungschale_Englisch_Download_03.04.17.pdf). Accessed 22 July 2022
12. Helmut Schmidt University. Digital Nameplate, 11 May 2022. <http://www.i40-aas.de/>. Accessed 22 July 2022
13. Arm, J., Benesl, T., Marcon, P., Bradac, Z., Schröder, T., Belyaev, A., et al.: Automated design and integration of asset administration shells in components of Industry 4.0. *Sensors* **21**(6) (2004)
14. StenGruener, aorzelskiGH, Boss B, degoell. Asset Administration Shell Frequently Asked Questions List. GitHub (2021). <https://github.com/admin-shell-io/questions-and-answers#readme>. Accessed 22 July 2022
15. Qi, Q., Tao, F., Zuo, Y., Zhao, D.: Digital twin service towards smart manufacturing. *Procedia CIRP* **72**, 237–242 (2018)
16. Belyaev, A., Diedrich, C., Espen, D., Lüdicke, B., Miny, T., Mrosowski, A., et al.: Discussion paper - AAS Reference Modelling - Exemplary modelling of a manufacturing plant with AASX Package Explorer based on the AAS metamodel. Plattform Industrie 4.0 (2021). [https://www.plattform-i40.de/IP/Redaktion/EN/Downloads/Publikation/AAS\\_Reference\\_Modelling.pdf?\\_\\_blob=publicationFile&v=5](https://www.plattform-i40.de/IP/Redaktion/EN/Downloads/Publikation/AAS_Reference_Modelling.pdf?__blob=publicationFile&v=5). Accessed 22 July 2022
17. Lv, B., Zhang, Y., Dai, W.: Integrated asset management model based on IEC 61499 and Administration Shell. In: *IECON 2021–47th Annual Conference of the IEEE Industrial Electronics Society*, pp. 1–6 (2021)
18. Adolphs, P., Auer, S., Bedenbender, H., Billmann, M., Hankel, M., Heidel, R., et al.: Structure of the Administration Shell - Continuation of the development of the reference model for the Industrie 4.0 component. ZVEI and VDI, Status Report (2016)
19. Ristin, M., Orzelski, A., Hoffmeister, M. (eds.): *AASX Package Explorer* (2021). <https://github.com/admin-shell-io/aasx-package-explorer>. Accessed 21 July 2022



**Open Access** This chapter is licensed under the terms of the Creative Commons Attribution 4.0 International License (<http://creativecommons.org/licenses/by/4.0/>), which permits use, sharing, adaptation, distribution and reproduction in any medium or format, as long as you give appropriate credit to the original author(s) and the source, provide a link to the Creative Commons license and indicate if changes were made.

The images or other third party material in this chapter are included in the chapter's Creative Commons license, unless indicated otherwise in a credit line to the material. If material is not included in the chapter's Creative Commons license and your intended use is not permitted by statutory regulation or exceeds the permitted use, you will need to obtain permission directly from the copyright holder.





# Digital Twins for Sustainability in the Context of Biological Transformation

Anne Seegrün<sup>(✉)</sup>, Janine Mügge, Theresa Riedelsheimer, and Kai Lindow

Fraunhofer Institute for Production Systems and Design Technology IPK, Berlin, Germany  
anne.seegrueen@ipk.fraunhofer.de

**Abstract.** Applying biological principles that are similar to those found in nature to product engineering and manufacturing offers new approaches to product and production systems and might lead to a significant contribution towards sustainability. By transferring materials, structures, and processes of natural to digital ecosystems industrial value creation can be optimized. A promising approach to establish a networked, self-regulating digital ecosystem represents a digital twin. The potential of digital twins within the context of biological transformation has not been researched yet. This paper attempts to provide a first entry into the research topic by identifying biological principles within the concept of a digital twin and analyzing its potential for biological transformation in the industry. As a main result, the paper presents a list of relevant principles of biological transformation based on a structured taxonomy. These are specified within the concept of a digital twin.

**Keywords:** Biological Transformation · Digital Twin · Sustainability · Biologicalization · Digitalization

## 1 Introduction and Research Approach

During the last two centuries, manufacturing systems have changed in shape and form innumerable times [1]. Up until now, the manufacturing industry is obliged to adapt due to emerging challenges such as demographic change, individualization, digitalization, the increasing scarcity of natural resources, and the growing demand for sustainability [2]. In response to many such demands, companies currently place their confidence in Industry 4.0 and digital transformation [3]. With regard to the fourth industrial revolution, the main items on the agenda are productivity gains, flexibility enhancements, and cost reductions, whereas sustainability commonly plays a subordinate role [4]. This is where Biological Transformation (BT) comes into play – a holistic approach to change industrial value creation towards sustainable optimized production systems, by an accelerating convergence of technical, digital, and biological systems in the manufacturing environment [5]. Embracing principles of nature by transferring materials, structures, and processes of natural to digital ecosystems harbors the great potential for sustainable and resource-efficient manufacturing [6]. The concept of a Digital Twin (DT) therefore represents a promising approach to establish a networked, self-regulating ecosystem

whose stability and resilience are to be monitored and controlled with regard to ecological parameters. The potential of DTs for sustainability in the context of BT has not been researched yet. Hence, this paper attempts to provide a first entry into the research topic by presenting a conceptual framework and addressing the following research questions: “What are the relevant biological principles of a DT for sustainability? (RQ I)” and “How can these biological principles be integrated into a conceptual framework of a DT in the context of BT to foster sustainability in industrial value creation? (RQ II)”.

In order to systematically answer these research questions, the state of the art of BT in manufacturing and DTs for sustainability will first be specified. As part of a systematic literature review on DTs in the context of BT, a more detailed understanding of the research area will be developed in order to deduce the research gap addressed within this paper. Starting from this gap, a conceptual framework will be derived that integrates biological principles into the concept of a DT for sustainability and serves as an initial provision of support. The result of the present paper must accordingly be regarded as a first basis that needs to be evaluated, specified, and applied in future research work.

## 2 State of the Art

### 2.1 Biological Transformation in Manufacturing

BT in general describes the holistic transformation from traditional industrial value creation towards sustainable value creation systems [7] by transferring principles, materials, functions, and structures from nature into technical systems [8]. The knowledge from nature is applied systematically in the context of BT in manufacturing [9] and pursues the aim of optimizing production systems regarding their societal and business challenges. In this context, a convergence of the bio- and technosphere is pursued [7]. The BT can be divided into three development modes [10], which include different levels of convergence of the bio- and technosphere [7]: *Inspiration* involves translating natural phenomena in the form of concepts (fluid dynamics, lightweight construction, biomechanics), processes of evolution (bio-analogue optimization techniques, swarm intelligence, neural networks), and principles of nature (resilience, self-organization, self-healing) into technical value creation systems [2, 7, 10]. *Integration* refers to the transfer of biological and technical processes to traditional value creation systems [7]. Examples include closed loops, the manufacturing of new products by using microorganisms to recover rare earth from magnets, extracting biofuel from CO<sub>2</sub> waste streams, and extracting methane from industrial wastewater [7, 11]. With digitalization and Industry 4.0, BT is experiencing a new dynamic. Beyond bio-inspired and bio-integrated approaches, current technological developments offer the possibility to foster sustainable value creation with the *interaction* of biological and technical systems by means of intelligent information systems such as the concept of a DT [8, 12]. The aim is to develop new and autonomous production technologies and structures [10].

The biological transformation has different facets, basically inspiration, integration, and interaction. These can be expressed in various principles of nature. One way to describe and structure these principles is through taxonomies. The Biomimicry Taxonomy, for instance, covers various principles in eight major categories, which can be transferred in abstract form to the solution of technical problems [13].

## 2.2 Digital Twins for Sustainability

In general, DTs can be defined as “a digital representation of an active unique product [...] or unique product-service system (a system consisting of a product and a related service)” [14]. A DT consists of the interlinkage of Digital Master-data, which are models and information from the planning phase, and production, usage, or end of life data of an individual system instance, the so-called Digital Shadow.

DTs for sustainability are based on the definition of DTs with the specific aim to foster sustainability in the form of a minimized environmental impact [15, 16]. One specific approach in this context is the calculation of the environmental impact with Life Cycle Assessment as standardized in the ISO 14044 [17]. With the help of a DT with integrated LCA, an “As planned-LCA” for different product design variants and corresponding process alternatives can already be carried out during the design phase of a product and be stored within the Digital Master (see A in Fig. 1). With the start of the production phase, the product generates an individual CO<sub>2</sub> footprint (“As is-LCA”) which is being captured along consecutive lifecycle phases via unique identifiers within the Digital Shadow (see B in Fig. 1). Through the linkage of master models and shadow data within the DT Core, lifecycle information such as data from production, usage, or end of life can be systematically made available and processed into valuable information. Thus, the comparison between “As planned-“ vs. “As is-LCA” (see C in Fig. 1) may enable the provision of insights for future product optimizations (Feedback to Design). However, analysis and interpretation within the DT Core (see D in Fig. 1) can also be used to execute control commands via direct feedback to the physical system, for instance, to optimize product behavior with regard to CO<sub>2</sub> emissions.

## 2.3 Digital Twins in the Context of Biological Transformation

To analyze the state of the art of research on DTs in the context of BT, a systematic literature review was conducted. Limiting the search query to the terms biological transform\* and digital twin\* resulted in zero hits in the databases Scopus, Web of Science, and eLib. To broaden the data set for the literature review, more general keywords were used. The query, formulated as followed, retrieved 24 publications: TITLE-ABS-KEY (“biological transform\*” OR “bio\*inspir\*” OR “bio\*integrat\*” OR “bio\*interact\*” OR “bio\*intelligen\*”) AND (“digital twin\*” OR “digitization” OR “digitalization” OR “digital technolog\*”). After screening the results in full text, the respective publications were rated as high-, medium- and low-appropriate for the subject matter. Publications with low appropriateness for analysis either had no specific reference to BT or digital solutions or included case studies from other domains being too specific to be transferred to manufacturing. Papers of the subject area “manufacturing”, that tended to consider the DT concept at a very high altitude or only as a marginal note have been rated with medium appropriateness. Publications with high appropriateness contained the term “Digital Twin” and will be described in more detail below.

Miehe et al. [10, 18] develop a framework of ten fields of action for BT of industrial value creation. According to their findings, the prerequisite for increased resilience of manufacturing systems are robust technologies constantly monitoring significant states of products, processes, and production systems. In the context of BT, the DT adopts the

function of a genotype (genetic data) to its respective component state, the phenotype, and thus, may act as an enabler for optimized process transparency and planning. With the help of simulation and bio-inspired algorithms (e.g. swarm intelligence, ant algorithms) this ‘manufacturing gene pool’ will continue to expand [19, 20].

Bergs et al. [3] introduce projects applying BT in manufacturing. The project EVOLOPRO represents a bio-inspired approach for the utilization of biological principles (e.g. diversity of variants, facilitated variation) for optimizing complex self-adapting production systems with the help of DTs. Here, the DT evolving through learning and interaction analyzes and evaluates the difference between a targeted and an actual state of a manufactured product by using evolution-based algorithms and thus, helping the production system to perform better in future situations (increased fitness).

Miehe et al. [12] examine the transferability of existing DT architectures (Asset Administration Shell (AAS), RAMI4.0 Architecture) to biological systems. Therefore, Miehe et al. present a scalable model integrating structural and functional features of biological systems for the interoperability between process steps across company borders for both technological and biological assets.

In summary, literature on DTs in the context of BT is scarce. Recent publications in this field ascribe DTs significant potential for biological transformed value creation (e.g. enhanced process transparency and planning, optimized production systems), but lack a general contextualization of the concept of a DT within BT. By identifying relevant biological principles within the concept of a DT for sustainability, this paper attempts to provide a first entry into the topic and fill in the identified research gap.

### 3 Concept of a Digital Twin in the Context of Biological Transformation

Based on the identified research gap, a conceptual framework for DTs for sustainability in the context of BT is proposed. The derived framework that is shown in Fig. 1 extends the current definition of Stark et al. [14] and Riedelsheimer et al. [15] to include the aspects of BT.

The DT accompanies its physical counterpart throughout its entire lifecycle [21]. Within this digital representation, selected characteristics, states, and behaviors of the product instance or system are reflected and models, information, and data are linked across lifecycle phases [14]. Along the lifecycle of a product, the DT uses enriched data sets on different product states, such as 3D models and product structures from CAD or PLM systems (“As designed”), manufacturing BOMs of the product instance from ERP or MES systems (“As built”), information on maintenance history (“As maintained”), or (real-time) data from the use phase (“As used”) [22].

Within this paper, BT in manufacturing is being referred to as a process of optimizing industrial value creation towards sustainability with concepts and technologies inspired by nature, integrating biological aspects, and operating in the interaction between digital and biological systems. The present framework is therefore primarily focusing on DTs for sustainability offering the opportunity to leverage existing data and optimize both the individual sustainability of the system and future product generations by means of an LCA (see Subsect. 2.2).

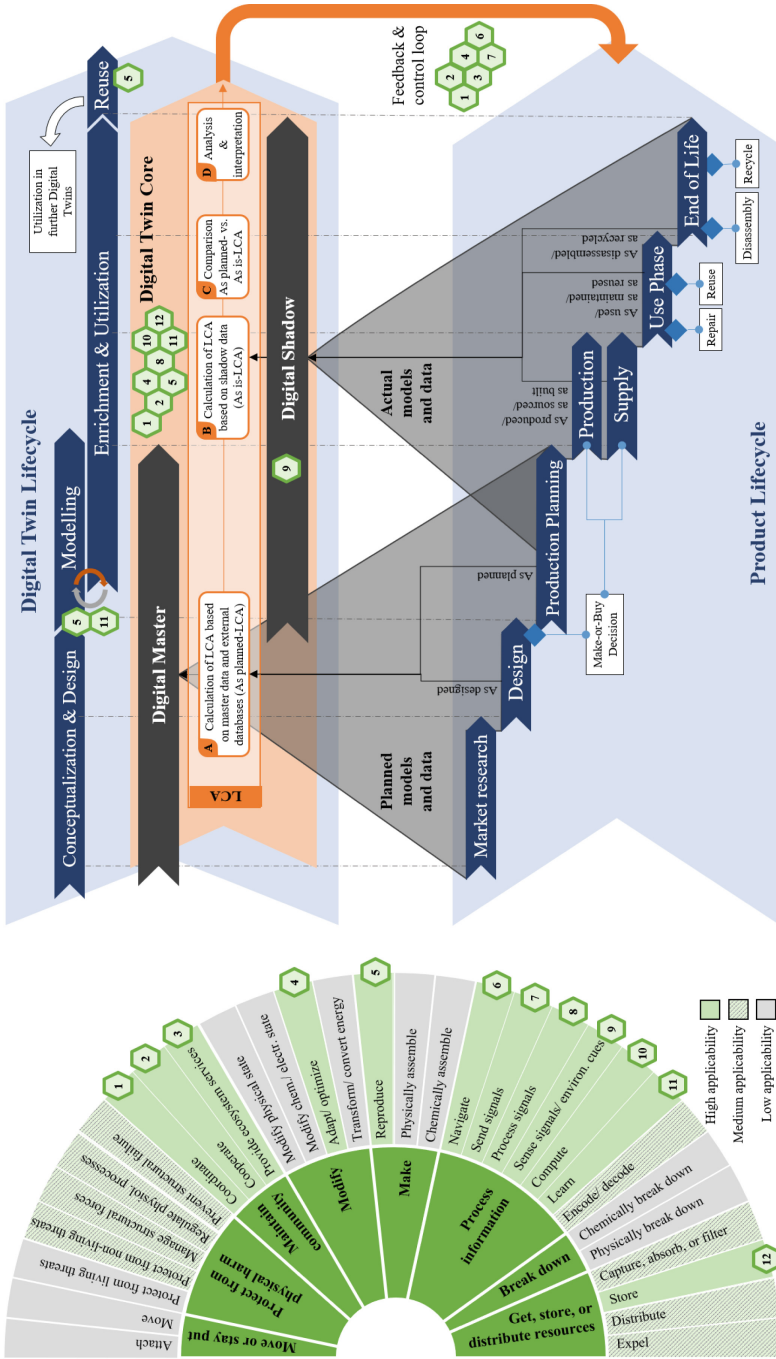


Fig. 1. Concept of a Digital Twin for Sustainability in the Context of Biological Transformation

In order to systematically address RQ I, relevant biological principles of the Biomimicry Taxonomy [13] were assessed according to their applicability to the concept of DTs for sustainability. The result of the assessment is depicted in Fig. 1. Principles with low applicability address natural characteristics that relate to physical changes of the ecosystem (e.g. “Physically assemble”, “Chemically break down”) and were thus excluded from further considerations. Biological principles which are assignable to a general concept of a DT, but lack a certain transferability to DTs for sustainability were rated as medium-applicable (e.g. “Manage structural forces”). In response to RQ II, the remaining high-applicable principles are listed in Table 1 with corresponding examples within a DT for sustainability. As a digital ecosystem a DT inherits various biological principles itself but also serves as an enabler of biological transformed products by equipping it with characteristics inspired from nature to ultimately optimize its resilience, stability, and sustainability.

**Table 1.** Biological principles and examples within a DT for sustainability

Biolog. Principle	Examples within a DT for sustainability
Coordinate	e.g. Coordination of processes along the lifecycle to reduce CO <sub>2</sub> footprint: Monitoring of ecological parameters and identification of optimization potential
Cooperate	e.g. Intelligent linkage between master models and shadow data along the lifecycle (internally, across companies/industries)
Provide ecosystem services	e.g. Provision of insights for future product optimizations (Feedback to Design), execution of control commands via direct feedback to the physical system, for instance, to optimize product behavior with regard to CO <sub>2</sub> emissions
Adapt/optimize	e.g. Adaptation/optimization of physical system based on monitoring of CO <sub>2</sub> footprint
Reproduce	e.g. Provision of a physical system’s copy and instantiation of DT along lifecycle and utilization for further Digital Twins (fleet, variants)
Navigate	e.g. Management of assets within production system with regard to ecological parameters for increased sustainability
Send signals	e.g. Visualization of “As planned-“ vs. “As is-LCA” in dashboard
Process signals	e.g. Calculation of LCA based on master data, external databases, and shadow data as well as comparison of “As planned-” vs. “As is-LCA”

(continued)

**Table 1.** (continued)

Biolog. Principle	Examples within a DT for sustainability
Sense signals/envIRON. Cues	e.g. Data acquisition of operational, state, or process data in Digital Shadow (e.g. energy consumption)
Compute	e.g. Analysis and interpretation of “As planned-“ vs. “As is-LCA”
Learn	e.g. Adaptation and optimization of DT itself based on historical data
Store	e.g. Storage of master models or shadow data with regard to ecological parameters

## 4 Conclusion and Outlook

BT as a holistic approach to change industrial value creation towards sustainable optimized production provides promising answers to current challenges such as resource scarcity, the reduction of ecological footprints, and climate change. A DT for sustainability offers the opportunity to optimize a product by impersonating the characteristics and functions of natural ecosystems. Leveraging and processing existing ecological data into valuable information along a product’s lifecycle, with the help of DTs might ultimately lead to enhanced resilience, stability, and sustainability of the physical counterpart. Given the absence of theoretical foundations in recent literature, the objective of this paper was to develop a conceptual framework of a DT in the context of BT (RQ II) by identifying relevant biological principles of a DT for sustainability (RQ I). The main academic contribution of the present paper lies in its attempt to fill in the identified research gap and broaden companies’ horizons towards the potential of DTs in the context of BT by providing a more holistic perspective. Given the diversity of DT use cases, the framework is deliberately kept general and therefore requires adjustments to individual project needs. Additionally, the potential to foster sustainability in manufacturing has not been quantified yet. In this connection, the impact and rebound effects of the DT on the ecosystem’s CO<sub>2</sub> footprint should not be neglected in subsequent research. To this end, the developed framework shall be considered as a starting point and evolving concept, which needs to be further detailed with insights gained from evaluation, practical application, and future research.

**Acknowledgments.** This paper was written as part of the research and development project „Biological Transformation 4.0: Further development of Industry 4.0 by integrating biological principles (BioFusion 4.0)“, which is funded by the German Federal Ministry of Education and Research (BMBF) and supervised by the Project Management Agency Karlsruhe (PTKA). The responsibility for the contents of this publication lies with the authors.



## References

1. Neugebauer, R., et al.: A new generation of production with cyber-physical systems: enabling the biological transformation in manufacturing. *J. Mach. Eng.* **19**(1), 5–15 (2019)
2. Mieke, R., et al.: Enabling bidirectional real time interaction between biological and technical systems: structural basics of a control oriented modeling of biology-technology-interfaces. *Procedia CIRP* **81**, 63–68 (2019)
3. Bergs, T., et al.: Application cases of biological transformation in manufacturing technology. *CIRP J. Manuf. Sci. Technol.* **31**, 68–77 (2020)
4. Hellmich, A., et al.: “Bio-inspired factories of the future.” Hannover. In: Proceedings of the Conference on Production Systems and Logistics: CPSL 2020 (2020)
5. Berkhahn, M., et al.: Taxonomy for Biological Transformation principles in the manufacturing industry. In: Proceedings of 18th Global Conference on Sustainable Manufacturing (2022) (to be published), to be published
6. Drossel, W., Dani, I., Wertheim, R.: Biological transformation and technologies used for manufacturing of multifunctional metal-based parts. *Procedia Manufac* **33**, 115–122 (2019). <https://www.sciencedirect.com/science/article/pii/S2351978919304937>
7. Mieke, R., et al.: The biological transformation of the manufacturing industry – envisioning biointelligent value adding. *Procedia CIRP* **72**, 739–743 (2018). <https://link.springer.com/content/pdf/10.1007%2F978-3-662-57303-7.pdf>
8. Byrne, G., et al.: Biologicalisation: biological transformation in manufacturing. *CIRP J. Manuf. Sci. Technol.* **21**, 1–32 (2018)
9. Patermann, C.: Innovation, Wachstum, Bioökonomie, Bioökonomie: Europa wird sich sputen müssen, um in der Umsetzung der Bioökonomie im industriellen Maßstab mitzuhalten. in *Blickwinkel*
10. Mieke, R., et al.: The biological transformation of industrial manufacturing: future fields of action in bioinspired and bio-based production technologies and organization. *Procedia Manufac.* **39**, 737–744 (2019)
11. Mieke, R., Full, J., Sauer, A.: Biointelligenz im Produkt und in der Produktion. In: *Handbuch Konstruktion*, 2nd ed., pp. 621–634. Carl Hanser, Munich (2018)
12. Mieke, R., Horbelt, J., Baumgarten, Y., Bauernhansl, T.: Basic considerations for a digital twin of biointelligent systems: applying technical design patterns to biological systems. *CIRP J. Manuf. Sci. Technol.* **31**, 548–560 (2020)
13. The Biomimicry Institute, Biomimicry Taxonomy. <https://asknature.org/resource/biomimicry-taxonomy/>. Accessed 3 May 2022
14. Stark, R., Damerau, T.: Digital twin. In: *CIRP Encyclopedia of Production Engineering*, pp. 1–8. Springer, Berlin, Heidelberg (2019)
15. Riedelsheimer, T., Neugebauer, S., Lindow, K.: Progress for life cycle sustainability assessment by means of digital lifecycle twins: a taxonomy. In: *EcoDesign and Sustainability II*, , 329–245. Springer Singapore, Singapore (2021)
16. Barni, A., et al.: Exploiting the digital twin in the assessment and optimization of sustainability performances. In: *Theory, Research and Innovation in Applications*, Portugal, pp. 706–713 (2018)
17. DIN EN ISO 14044:2006, 14044 (2006)
18. Mieke, R., et al.: The biological transformation of industrial manufacturing: technologies, status and scenarios for a sustainable future of the German manufacturing industry. *J. Manuf. Syst.* **54**, 50–61 (2020)
19. Werfel, J., Petersen, K., Nagpal, R.: Designing collective behavior in a termite-inspired robot construction team, (eng), *Science* (New York, N.Y.), vol. 343, no. 6172, pp. 754–758 (2014)
20. Parker, C., Zhang, H., Kube, C.: Blind bulldozing: multiple robot nest construction. In: *Proceedings 2003 IEEE/RSJ International Conference on Intelligent Robots and Systems (IROS 2003)*, pp. 2010–2015 (2003)

21. Riedelsheimer, T., Lindow, K., Stark, R.: Feedback to Design with Digital Lifecycle-Twins: literature review and concept presentation. In: Design for X: Beiträge zum 29. DfX-Symposium September 2018, pp. 203–214. Tutzing (2018)
22. Himstedt, S.: Digitaler Zwilling und Produktion 4.0. Zeitschrift für wirtschaftlichen Fabrikbetrieb **115**(s1), 41–42 (2020)

**Open Access** This chapter is licensed under the terms of the Creative Commons Attribution 4.0 International License (<http://creativecommons.org/licenses/by/4.0/>), which permits use, sharing, adaptation, distribution and reproduction in any medium or format, as long as you give appropriate credit to the original author(s) and the source, provide a link to the Creative Commons license and indicate if changes were made.

The images or other third party material in this chapter are included in the chapter's Creative Commons license, unless indicated otherwise in a credit line to the material. If material is not included in the chapter's Creative Commons license and your intended use is not permitted by statutory regulation or exceeds the permitted use, you will need to obtain permission directly from the copyright holder.





# Virtual Experiments for a Sustainable Battery Cell Production

Jonathan Krauß<sup>1</sup>(✉), Thomas Ackermann<sup>1</sup>, Alexander D. Kies<sup>2</sup>, David Roth<sup>1</sup>,  
and Miriam Mitterfellner<sup>1</sup>

<sup>1</sup> Fraunhofer Research Institution for Battery Cell Production FFB, Bergiusstr. 8, 48165  
Münster, Germany

jonathan.krauss@ffb.fraunhofer.de

<sup>2</sup> Fraunhofer Institute for Production Technology IPT, Steinbachstr. 17, 52074 Aachen, Germany

**Abstract.** On the path towards a sustainable society, the availability of energy storage systems is an essential step – leading to increased demand for batteries. To achieve a sustainable society, it is necessary to manufacture batteries also in a sustainable way. One approach lies in virtual experiments. They aim at identifying parameters, recipes, and technologies in the digital world, before applying them to the physical production system. Thus, manufacturing is optimized in regard to sustainability indicators such as material consumption, emission, and waste – but also in regard to costs, quality, and yield. The faster ramp-up is especially important in the production of battery cells, due to the highly complex processes and critical materials. In this paper, we introduce a concept for virtual experiments platform in battery cell production. It includes collection of data, data aggregation, a simulation environment, as well as an optimizer. Also, it is integrated into existing production and IT systems. The virtual experiments platform functions as a service of a digital twin. Validation is conducted by realizing the virtual experiments platform on the electrode production of lithium-ion batteries.

**Keywords:** Battery Cell Production · Sustainability · Digital Twin · Virtual Experiment · Digitalization

## 1 Motivation

The advancing climate change necessitates a shift from the use of conventional energy sources to renewable ones, which is accompanied by the indispensability of efficient storage of electrical energy, leading to a rapid increase in demand for battery cells [1, 2]. In the context of battery cell production, sustainability is proving to be a key challenge. Especially the use of digital twins can offer a solution for this challenge [3]. One specific approach that can lead to reducing the resource-intensive initial period for identifying machine parameters is the use of virtual experiments. This is to use less of the materials in production that may themselves have to be sourced from non-sustainable sources. Thus, the input/output ratio can be improved and a more sustainable battery cell production can be achieved. The concept of virtual experiments in battery cell production based on the digital twin is presented in this paper and the concept is evaluated in the context of electrode production.

© The Author(s) 2023

H. Kohl et al. (Eds.): GCSM 2022, LNME, pp. 585–594, 2023.

[https://doi.org/10.1007/978-3-031-28839-5\\_66](https://doi.org/10.1007/978-3-031-28839-5_66)

## 2 State of the Art

### 2.1 Battery Cell Production

A battery cell consists of a cathode, an anode, collectors, a separator, the electrolyte, and a housing [4]. For many applications that rely on mobile energy storage, the lithium-ion batteries have emerged as the best solution in recent years. Production of the cells is divided into three main segments: electrode production, cell assembly, and activation or formation [5]. In electrode production – on which the explanations in this contribution focus – the production for anode and cathode follows the same process steps. The electrode foils are coated with a paste of active materials – the slurry – dried, calendered, slitted into narrower electrode strips, and finally vacuum dried [4, 6].

### 2.2 Sustainability

Sustainability is broadly defined as “the ability to meet the needs of the present without compromising the ability of future generation to meet their own needs” [7]. Today ecosystems are exceeding the capacity for self-regulation from man-made disruptions. Climate change, overexploitation of land and natural resources, and loss of biodiversity are outcomes of these disruptions in ecosystems [8]. Therefore the use of resources must be adequately planned and emissions to air, water, and soil have to be measured and minimized. The ISO normed method of life cycle assessment (LCA) captures all material, energy, and emission flows that occur during the life cycle of a product system. From this ecological status-quo analysis, different scenarios for optimization can be investigated to enhance sustainability performance. Sustainability always bases on the three pillars of ecology, economy, and society [9]. This implies that sustainable and economic targets are not – as often perceived – contrary concepts, but are integrated in each other, therefore creating a strong interdependence. Nonetheless each pillar of sustainability can be targeted individually, but consequences for the other pillars have to be taken into account.

### 2.3 Digitalization for a Sustainable Battery Cell Production

Battery cell production is very energy-intensive and requires critical raw materials [10]. Digitalization can help to enable sustainable battery cell production in all pillars: economic, environmental, and social. The basis for this is created by the digital twin, which is a digital representation of physical objects. It includes the properties, states, and behavior of the object via data, models, and information [11]. The data generated during production can be aggregated in the respective digital twins, stored, and thus used for a variety of services – e. g. for simulations, or as input data for an LCA.

Predictive maintenance or adaptive production can have a direct impact on economic key figures in the form of cost reductions. For this, the linking and analysis of data from the machine and product twin is essential, as this is the only way to make reliable predictions based on the production data.

Social sustainability aspects can also be addressed by digitalized battery production. For example, the creation of transparency regarding the entire value chain of battery production is an essential factor in avoiding social injustice in the future. This transparency

can be enabled by the digital twin of the product, which contains data on the type of production or the origin of the materials. It serves also as a basis for automated LCA or the Battery Passport which is targeted by the European Union [12].

Furthermore, to enable the goal of ecologically sustainable production, data-based simulation use cases can be realized that increase the input/output ratios in cell manufacturing in the long term through optimized use of resources and energy.

Simulation is intended to mimic the behavior of a physical scenario, whose effects are applied to a physical system [13]. In the field of battery cell production, there is related work addressing concepts for simulating impacts of the entire process chain on the battery performance such as [13]. Moreover, they state that various interdependencies in the complex battery cell production process are still unknown, and thus stressing the desire for more transparency [13]. Schönemann *et al.* [14] focus on a holistic framework for coupling multiple submodels of a battery cell production system, enabling transparency on process chain level. Thomitzek *et al.* [15] propose a multi-paradigm simulation for the entire process chain, focusing on energy demand. However, besides these holistic approaches on battery process chain level, no platform has been developed so far using a combination of simulation models that allows for optimizing machine parameters while considering the peculiarities of the specific process step, its intermediate product quality, and its interdependency to the final battery performance. To narrow this gap, we propose to establish a user-friendly virtual experiments platform for realistic experiments at the process step level. It would enable process experts to plan experiments more efficiently and support the production of high-quality intermediate products for the subsequent process step. The use of virtual experiments can help to reduce the resource-intensive setting of machine parameters for production [16].

### 3 Conception of Virtual Experiments

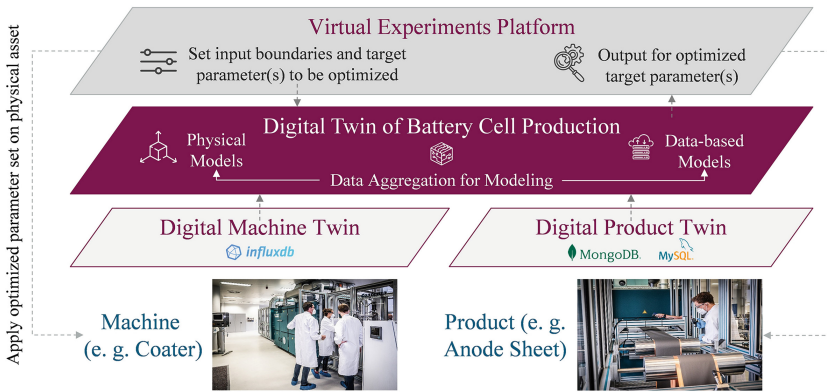
#### 3.1 Setting the Goal of Virtual Experiments

The idea of virtual experiments is to support the parameter optimization in terms of sustainability measures in a virtual space. In other words, virtual experiments are not simulations, but virtual representations of real experiments that can be manipulated in the digital world to a certain extent. Thus, virtual experiments represent a special application of simulation-based engineering of production processes that aim to decrease the time to develop a product with optimal parameters in a virtual space before producing it on the physical machine. [17] Therefore, among other sustainability-related measures, the use of input materials as well as energy consumption will be decreased using virtual experiments. Moreover, virtual experiments increase transparency by supporting to understand cause-effect relationships of machine input parameters and output parameters of the product. In this case, virtual experiments are applied for understanding the process by simulating various parameter sets of the depicted machine.

#### 3.2 Virtual Experiments Platform Design

Figure 1 illustrates the big picture of the virtual experiments platform (VEP). The bottom layer consists of the physical assets, on which physical experiments are conducted.

In production, these physical assets are the production machine and the product that is crafted on the respective machine. For both, the product as well as the machine, digital twins are used. Within the digital twin of the battery cell production, the data, models, and information of the relevant machine and product twins are aggregated. These aggregations are, for example, training data sets that link the machine parameters provided by the digital machine twin (e. g. of the coater) with the quality parameters that belong to the crafted product, e. g. the produced electrode foil. The quality parameters of the product are provided by the digital product twin. The data-based models and physical models that represent the characteristics of the particular process step are the basis of the VEP, which runs as a service of the digital twin of the battery cell production. The VEP allows for setting the input boundaries of machine parameters as well as parameters to be optimized (e. g. quality, energy, and material consumption). Based on the models, the parameters are shown within the VEP. The following step is to apply the optimized parameter set on the physical asset and validate the virtual experiment.



**Fig. 1.** Big Picture of the Virtual Experiments Platform (photos © Studio Wiegel).

### 3.3 Development of the Virtual Experiments Platform

In the following, an iterative development approach for the VEP is proposed. The general procedure bases on design thinking, which is useful for addressing complex issues by integrating the end user’s perspective [18, 19]. Design thinking has already been used in platform development to ensure that the needs of end users are considered [20].

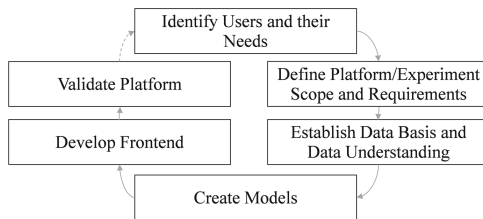
Similar to the design thinking methodology, the development process for virtual experiments is executed in an iterative way so that a first version is available in early stages, which can then be improved. The first step of the development process of a VEP is to incorporate the perspective of the end user by identifying stakeholders and determining the need for virtual experiments similar to the *Understand and Observe* stages of design thinking [21]. Based on the understanding of the user needs, the platform’s scope and requirements can be defined in the next step. For this purpose, it is necessary to assess which experiments should be represented within the platform by identifying the critical

cause-effect relationships for sustainability through expert interviews or quantitative analysis. Moreover, the complexity of the experiments needs to be defined by specifying whether the parameters within experiments should be optimized with respect to a single optimization objective or multiple objective variables in parallel. As sustainability in production is dependent on several factors in parallel, it can be defined as a multi-objective optimization problem.

To establish the data basis for a VEP, physical experiments have to be conducted in the second stage. The reason for this is two-fold. On the one hand, data-driven models such as machine learning algorithms need data for generating well-performing models. On the other hand, even for physical models a data basis is needed since expert knowledge is required for these models which can only be generated through physical experiments. Furthermore, physical models have to be validated on real data. For a VEP whose primary goal is to increase sustainability, there exist approaches that allow the data basis to be generated in a sustainable way by using as few input materials as possible while maximizing the exploration of the decision space [22, 23].

Once the data basis is ensured by conducting physical experiments, the frontend of the platform can be developed and connected with the models that are generated and validated on the data basis. The frontend should at least allow to set the input boundaries of the experiment and the target parameters as illustrated in Fig. 1. Based on the prediction of the models, the optimized target parameters and corresponding input parameters should be visualized in the platform.

Similar to the last phase of design thinking, the final process stage of VEP development entails the validation by users to assess whether the requirements are reached. If adjustments are necessary, the next iteration of the development cycle begins. The iterative process that has been described in this section is illustrated in Fig. 2.



**Fig. 2.** Virtual Experiments Platform Design Process.

## 4 Application of Concept in Battery Cell Production

The developed concept of VEP was applied in battery cell production at a coating line of Fraunhofer Research Institution for Battery Cell Production FFB. Due to its modular structure, transferability to other production processes and environments is given.

#### 4.1 Coating Line at FFB Workspace

In 2021, Fraunhofer started operating a coating line with clean room technology – the “FFB Workspace”. Its focus lies on innovative production procedures for slurry mixing, coating, and drying in the electrode production. The production machinery consists of a twin-screw extruder for continuous slurry mixing and a slot die coater with attached dryer for anode coating. As the research team experiments with continuous mixing techniques and different materials, the production recipes are frequently changed. Each change in the production recipe can lead to a different behavior of the machinery during the potentially material intensive and time-consuming ramp-up phase. The optimization of these ramp-up phases is one possible use case for which a VEP is developed via the methods described in Sect. 3.

#### 4.2 Implementation of the Process at FFB Workspace

As described in Sect. 3.3 the design process for developing the VEP starts with identifying the users of the platform and their needs. For this purpose, interviews with experts for electrode production are conducted to define use cases for the slurry mixing and coating/drying process. Possible general use cases could be to find ramp-up recipes with reduced material throughput or to find faster ramp-up procedures for configuring the process parameters. The specific parameters to be optimized during slurry mixing or coating/drying will be chosen, building on preliminary research on cause-effect relationships in battery cell production [24]. Based on these requirements, the scope of the platform and the experiments can be defined. Real experiments on the extruder and/or coater are planned and conducted to create the needed data basis consisting of the process parameters and inline quality measurements. The data basis also includes additional offline quality measurements – e. g. the slurry viscosity – and input material qualities. The subsequent steps in the design process, which are the model creation, frontend development and the platform validation follow as described in Sect. 3.3. Table 1 lists the specific content underlying the VEP components for an example use case of the coating/drying process focusing on optimizing the product quality.

#### 4.3 Digital Infrastructure for the Realization of the VEP

The digital infrastructure to realize the VEP is based on the big picture presented in Fig. 1. The machinery is connected via an OPC UA interface [31]. The process parameters, inline quality parameters, and machine states are read out via OPC UA and stored in time series databases as part of its respective digital machine twin. Offline quality parameters and material data are stored in relational and document-oriented databases as part of the digital product twin.

The relevant data out of these databases is aggregated in data sets and transformed into suitable data formats in the combined digital twin of production. These data sets will then be used for validating the physical models or training the data-based models. The simulations with these models shall run as services on the combined digital twin where the communication with the VEP will be made possible via its API. The VEP can run outside of the digital twin, e. g. as a web service, depending on the needs of the users. The advantages and disadvantages of the VEP are summarized in Table 2.



**Table 1.** VEP content for a use case of coating/drying process with focus on product quality

VEP Component	Specific Content	Realization Type	Related Work
VEP front end	Selection of target parameters (e. g. layer thickness and cell capacity) and input boundaries	Connecting target parameters and input boundaries with models (e. g. for predicting cell capacity and layer thickness)	
Physical model	Fluid simulation of slot die	CFD simulation	[25]
	Heat transfer in dryer	Analytical model	[26]
Data-based model	Prediction of electrode heterogeneity	Machine Learning model	[27]
	Assessment of cell capacity	Machine Learning model	[28]
Data aggregation for modeling	Aggregation of machine and quality parameters, e. g. slot die settings and layer thickness	Digital twin middleware	
	Cell-specific aggregations	Traceability system	[29]
Digital twins	Semantic model of the asset (e. g., meta data, machine states/quality parameters, models)	Asset administration shell	[30]

**Table 2.** Advantages and Disadvantages of a Virtual Experiments Platform.

Advantages	Disadvantages
Enabling faster ramp-up of battery cell production Stable platform and high availability due to open-source software technology stack Creation of data basis for training or validating models Better understanding of cause-effect relationships	More expertise and disciplines necessary in the ramp-up, such as computer science and simulation Additional effort for developing platform Models need to be adapted if process changes on physical side

## 5 Conclusion

In this paper, the need of sustainable battery cell production processes was presented. Digital twins were identified as enablers for a more sustainable battery cell production, as their data aggregation can be used as the basis for many services, ranging from visualization to advanced services such as the VEP introduced in this paper. The idea of virtual experiments is to accelerate parameter optimization in terms of sustainability measures and decrease the actual physical experiment effort. Thus, material consumption can be reduced. The user sets input boundaries and target parameters to be optimized and the platform returns the optimized parameter set which is then applied on the actual machine. For developing such a platform, an iterative six-step development approach based on design thinking was proposed. Similar to design thinking, an end user perspective is adopted. Finally, it was described how the virtual experiments platform can be applied in the battery cell production using the example of the electrode production in the “FFB Workspace”. Further research should lie on broadening the validation of the VEP conception to increase sustainability in the battery cell production.

**Acknowledgements.** “FoFeBat – Forschungsfertigung Batteriezelle Deutschland” is funded by the Federal Ministry of Education and Research. Reference number: 03XP0256, 03XP0416.

## References

1. Lewerenz, S.: Pros and cons of batteries in green energy supply of residential districts — a life cycle analysis. In: Albrecht, S., Fischer, M., Leistner, P., Schebek, L. (eds.) *Progress in Life Cycle Assessment 2019*. SPLCEM, pp. 159–172. Springer, Cham (2021). [https://doi.org/10.1007/978-3-030-50519-6\\_12](https://doi.org/10.1007/978-3-030-50519-6_12)
2. Bundesministerium für Wirtschaft und Klimaschutz, Batterien “made in Germany” – ein Beitrag zu nachhaltigem Wachstum und klimafreundlicher Mobilität. <https://www.bmwk.de/Redaktion/DE/Dossier/batteriezellfertigung.html>. Accessed 11 May 2022
3. Mondejar, M.E., et al.: Digitalization to achieve sustainable development goals: Steps towards a smart green planet. *Sci. Total Environ.* **794**, 148539 (2021). <https://doi.org/10.1016/j.scitotenv.2021.148539>
4. Kampker, A.: *Elektromobilproduktion*, 1st ed. Springer Berlin (2014). <https://ebookcentral.proquest.com/lib/kxp/detail.action?docID=1731217>
5. Pettinger, K.H., Kampker, A., Hohenthanner, C.R., Deutschens, C., Heimes, H., vom Hemdt, A.: Lithium-ion cell and battery production processes. In: Korthauer, R. (ed.) *Lithium-Ion Batteries: Basics and Applications*, pp. 211–226. Springer, Heidelberg (2018). [https://doi.org/10.1007/978-3-662-53071-9\\_17](https://doi.org/10.1007/978-3-662-53071-9_17)
6. Brodd, R.J., Tagawa, K.: Lithium-ion cell production processes. In: van Schalkwijk, W.A., Scrosati, B. (eds) *Advances in Lithium-Ion Batteries*, pp. 267–288. Springer, Boston (2002). [https://doi.org/10.1007/0-306-47508-1\\_10](https://doi.org/10.1007/0-306-47508-1_10)
7. Brundtland, G.H.: *Our Common Future: Report of the World Commission on Environment and Development*. United Nations, Geneva (1987)
8. Persson, L., et al.: Outside the safe operating space of the planetary boundary for novel entities. *Environ. Sci. Technol.* **56**(3), 1510–1521 (2022). <https://doi.org/10.1021/acs.est.1c04158>

9. Barbier, E.B.: The concept of sustainable economic development. *Envir. Conserv.* **14**(2), 101–110 (1987). <https://doi.org/10.1017/S0376892900011449>
10. Degen, F., Schütte, M.: Life cycle assessment of the energy consumption and GHG emissions of state-of-the-art automotive battery cell production. *J. Clean. Prod.* **330**, 129798 (2022). <https://doi.org/10.1016/j.jclepro.2021.129798>
11. Stark, R., Kind, S., Neumeyer, S.: Innovations in digital modelling for next generation manufacturing system design. *CIRP Ann.* **66**(1), 169–172 (2017). <https://doi.org/10.1016/j.cirp.2017.04.045>
12. Proposal for a Regulation of the European Parliament and of the Council concerning batteries and waste batteries, repealing Directive 2006/66/EC and amending Regulation (EU) No 2019/1020: 2020/0353 (COD) (2020)
13. Thomitzek, M., Schmidt, O., Röder, F., Krewer, U., Herrmann, C., Thiede, S.: Simulating process-product interdependencies in battery production systems. *Procedia CIRP* **72**(1), 346–351 (2018). <https://doi.org/10.1016/j.procir.2018.03.056>
14. Schönemann, M., Bockholt, H., Thiede, S., Kwade, A., Herrmann, C.: Multiscale simulation approach for production systems. *Int. J. Adv. Manuf. Technol.* **102**(5–8), 1373–1390 (2019). <https://doi.org/10.1007/s00170-018-3054-y>
15. Thomitzek, M., von Drachenfels, N., Cerdas, F., Herrmann, C., Thiede, S.: Simulation-based assessment of the energy demand in battery cell manufacturing. *Procedia CIRP* **80**(1), 126–131 (2019). <https://doi.org/10.1016/j.procir.2019.01.097>
16. McAfee, M., Kariminejad, M., Weinert, A., Huq, S., Stigter, J.D., Tormey, D.: State estimators in soft sensing and sensor fusion for sustainable manufacturing. *Sustainability* **14**(6), 3635 (2022). <https://doi.org/10.3390/su14063635>
17. Lemu, H.G.: Virtual engineering in design and manufacturing. *Adv. Manuf.* **2**(4), 289–294 (2014). <https://doi.org/10.1007/s40436-014-0085-y>
18. Plattner, H., Eds.: *Design Thinking Research: Measuring Performance in Context*, 1st ed. Springer, Berlin (2012)
19. Brown, T.: Design thinking. *Harvard Bus. Rev.* **86**(6), 84 (2008)
20. Friedrich, M., Borkowski, M., Lieb, J.: A multi-UAS platform to accelerate situation assessment in first response missions – identification of user needs and system requirements using design thinking. In: 39th DASC - Digital Avionics Systems Conference: Virtual conference, 11-16 October 2020, pp. pp. 1–7, San Antonio, TX, USA (2020)
21. Plattner, H., Meinel, C., Weinberg, U.: *Design Thinking: Innovation lernen - Ideenwelten öffnen*. München: mi-Wirtschaftsbuch Finanzbuch Verl. (2011)
22. Maier, M., Rupenyan, A., Akbari, M., Zwicker, R., Wegener, K.: Turning: autonomous process set-up through bayesian optimization and Gaussian process models. *Procedia CIRP* **88**, 306–311 (2020). <https://doi.org/10.1016/j.procir.2020.05.033>
23. Solnik, B., Golovin, D., Kochanski, G., Karro, J. E., Moitra, S., Sculley, D.: Bayesian optimization for a better dessert (2017)
24. Abramowski, J.-P., et al.: Identifikation qualitätskritischer parameter. *Zeitschrift für wirtschaftlichen Fabrikbetrieb* **116**(10), 695–700 (2021). <https://doi.org/10.1515/zwf-2021-0154>
25. Schmitt, M.: Slot die coating of lithium-ion battery electrodes. Erscheinungsort nicht ermittelbar: KIT Scientific Publishing (2016). <https://directory.doabooks.org/handle/20.500.12854/59466>
26. Kumberg, J., et al.: Drying of lithium-ion battery anodes for use in high-energy cells: influence of electrode thickness on drying time, adhesion, and crack formation. *Energy Technol.* **7**(11), 1900722 (2019). <https://doi.org/10.1002/ente.201900722>
27. Duquesnoy, M., Boyano, I., Ganborena, L., Cereijo, P., Ayerbe, E., Franco, A.A.: Machine learning-based assessment of the impact of the manufacturing process on battery electrode

- heterogeneity. *Energy AI* **5**(229361), 100090 (2021). <https://doi.org/10.1016/j.egyai.2021.100090>
28. Liu, K., Niri, M.F., Apachitei, G., Lain, M., Greenwood, D., Marco, J.: Interpretable machine learning for battery capacities prediction and coating parameters analysis. *Control. Eng. Pract.* **124**(4), 105202 (2022). <https://doi.org/10.1016/j.conengprac.2022.105202>
  29. Riexinger, G., et al.: Integration of traceability systems in battery production. *Procedia CIRP* **93**, 125–130 (2020). <https://doi.org/10.1016/j.procir.2020.04.002>
  30. Federal Ministry for Economic Affairs, Details of the Asset Administration Shell: Part 1 - The exchange of information between partners in the value chain of Industrie 4.0 (Version 3.0RC02). [https://www.plattform-i40.de/IP/Redaktion/DE/Downloads/Publikation/Details\\_of\\_the\\_Asset\\_Administration\\_Shell\\_Part1\\_V3.pdf?\\_\\_blob=publicationFile&v=10](https://www.plattform-i40.de/IP/Redaktion/DE/Downloads/Publikation/Details_of_the_Asset_Administration_Shell_Part1_V3.pdf?__blob=publicationFile&v=10). Accessed 21 Jul 2022
  31. OPC foundation, Unified Architecture. <https://opcfoundation.org/about/opc-technologies/opc-ua/>. Accessed 23 Jul 2022

**Open Access** This chapter is licensed under the terms of the Creative Commons Attribution 4.0 International License (<http://creativecommons.org/licenses/by/4.0/>), which permits use, sharing, adaptation, distribution and reproduction in any medium or format, as long as you give appropriate credit to the original author(s) and the source, provide a link to the Creative Commons license and indicate if changes were made.

The images or other third party material in this chapter are included in the chapter's Creative Commons license, unless indicated otherwise in a credit line to the material. If material is not included in the chapter's Creative Commons license and your intended use is not permitted by statutory regulation or exceeds the permitted use, you will need to obtain permission directly from the copyright holder.





# Conceptual Approach for a Digital Value Creation Chain Within the Timber Construction Industry – Potentials and Requirements

N. Schramm<sup>2</sup>, N. Oertwig<sup>2(✉)</sup>, and H. Kohl<sup>1,2</sup>

<sup>1</sup> Chair of Sustainable Corporate Management, Technische Universität Berlin, Straße des 17. Juni 135, 10623 Berlin, Germany

<sup>2</sup> Fraunhofer-Institute for Production Systems and Design Technology IPK, Pascalstraße 8-9, 10587 Berlin, Germany

[nicole.oertwig@ipk.fraunhofer.de](mailto:nicole.oertwig@ipk.fraunhofer.de)

**Abstract.** This paper addresses the megatrend of urbanization as well as the associated challenges of climate change and its relation to sustainable manufacturing. An enormous lever for improving the climate balance is offered by the consistent use of renewable building materials. In the Berlin/Brandenburg metropolitan region, wood as a building material in particular should play a central role in achieving the climate targets. To realize this, it is not only necessary to use the potential of wood as a raw material for storing carbon, but also to embed wood construction in regional value chains and integrated digital production systems in order to be able to optimally design innovative value creation fields, new regional products and efficient material cycles for increasing sustainability. In the context of this work, the information flows along the value chain are investigated and transferred into a digital model. Existing digital concepts such as the “Open BIM” approach (Building Information Modeling) have been incorporated and shape the entirety of the value chain module developed in this paper for serial prefabrication in multi-story timber construction. Material and information flows are analyzed, interfaces between the actors are identified, value-adding factors of timber system construction are systematically examined for their effects, and industrial prefabrication is aligned with a digital model.

**Keywords:** Manufacturing Systems · Sustainable Smart Cities · Digital Value Creation Chain · Wooden Construction

## 1 Motivation

At present there is a dynamic environment which, in the name of environmental protection, places high demands and new framework conditions on the entire sector of the construction industry. In addition to government measures and legal regulations, the construction industry is independently able to determine the demand for cement and thus regulate one of the largest greenhouse factors. Cement and concrete are of great importance for construction and infrastructure projects, but their impact on the greenhouse

effect is just as great. The production of cement, the binding agent in the manufacture of concrete, alone accounts for around eight percent of global CO<sub>2</sub> emissions. In addition, with the exception of a few aggregates, all the starting materials for concrete are primary raw materials, the extraction of which requires energy and impairs or even destroys the landscape and nature. Wood as a storing product for carbon offers a promising alternative here. Buildings are considered to be the most sustainable storage facilities because they have a long-lasting life cycle [1]. In scientific comparative analyses, it has already been demonstrated that building constructions made of wood can save up to 56 percent greenhouse gases compared to a mineral-based one [2]. This can be further increased through cascade use. An essential cornerstone in the further development of sustainable urban concepts is still the affordability of building and living. The building culture in Germany emphasizes these points and seeks to reconcile the ecological, economic and sociocultural dimensions. In Berlin concrete measures and recommendations for action are based on the resolution of the Berlin House of Representatives of March 21, 2019. Under the title “Sustainability in construction: Berlin builds with wood” [3], wood as a building material is to be used to a much greater extent in Berlin and, as a carbon dioxide reservoir, contribute to climate protection and resource efficiency. In doing so, the Senate is called upon to support forestry, crafts, industry and science in order to develop Berlin-Brandenburg into a region of timber construction. However, the increased use of wood as a building material for multi-story residential buildings requires an increased industrial scaling of the manufacturing processes. Therefore, the development of a horizontally and vertically digitally networked value chain for urban housing construction based on an economic and resource-efficient production system is required. Focusing on the wood construction sector of course such an approach has to tackle various challenges.

These major challenges exist in following areas:

- High re-planning efforts for prefabricator due to regulatory restriction in Germany prohibiting involvement of executing companies in planning processes of building
- Missing flexibility of prefabricators in transferring individualized architectural designs into production systems
- Missing competences and capacities by flexible craft-oriented prefabricator to scale up their production to an industrialized one
- Missing approaches for an iterative sustainability assessment of wooden buildings along the entire life-cycle

As a first step on this change, chapter two investigates on the current driver in the wood construction sector followed by a brief description on the current situation with regard to the interaction of planning and pre-manufacturing tasks in chapter three. Chapter four addresses the role of Building Information Modelling (BIM) as one possible enabler for a sustainable digital value chain and finally chapter five is summarizing specific requirements and fields of action.

## **2 Current Driver in Wood Construction Sector**

The technical possibilities for prefabrication of wooden building systems have expanded greatly in recent years [4]. Most of these solutions are applied in the single-family house

area. This is particularly due to the fact that here the element variants are limited and the prefabricators work with standardized superstructures and connections that are company specific developed and optimized. The guiding principles of prefabrication include the standardization of work steps, the systematization of process planning, and interdisciplinary cooperation between planners and those carrying out the work. According to the industrialization paradigms in construction developed by GRIMSCHEID, process orientation is one major pillar [5]. In the area of multi-story buildings, the potential is not fully exploited, since here the effort for planning and organization increases considerably with the number of element variants. In practice, the great design freedom of architects leads to individually developed superstructures and connections which, as project-specific detailed solutions, have virtually no repetition in prefabrication.

In general, industrialization requires interdisciplinary planning, as well as close cooperation between all involved planners, suppliers and executing companies, based on processes that link activities with defined follow-up relationships and with a continuous flow of information. The basic principle of individualized mass production is based on the intensive use of the most modern information and communication technologies in conjunction with modern manufacturing processes. The additional costs arising from customized production consist largely of information costs. The transmission of specifications to the production department, the increased complexity in production planning and control, coordination with the trades and suppliers involved in the prefabrication, as well as targeted distribution logistics are just a few indicators of the high and cost-intensive information and communication requirements. [6].

The core task of information technologies in the context of mass customization is to transfer the information about the specification of the customer's requirements at the right time and in the right place. A promising approach lies in the integration of prefabrication and integral planning with extended BIM components (Building Information Model). In this way, the increasing demand for urban and affordable living space can be met with the necessary sustainability goals in product as well as in production [7]. The following chapter introduces the actual situation on that purpose.

### **3 Status Quo Analysis of the Value Chain**

The aim of the status quo analysis (see Fig. 1) was to examine the value chain with regard to existing findings from relevant studies and projects in order to derive a concretization of the digitization level of the timber construction industry based on this. For this purpose, a structured research and interviews were conducted with stakeholders along the value chain. The findings of these investigations have been transferred into a value chain model. A comprehensive view of value creation can be taken by the value creation factors of product, organization, equipment, process and people [8]. An integrated mapping of the factors described can be achieved by using enterprise models. Therefore, a value chain model has been created using the Integrated Enterprise Modelling Method (IEM) [9].

In a next step further investigation on existing digital solutions, research projects and challenges and opportunities took place for the derivation of specific potentials and requirements.

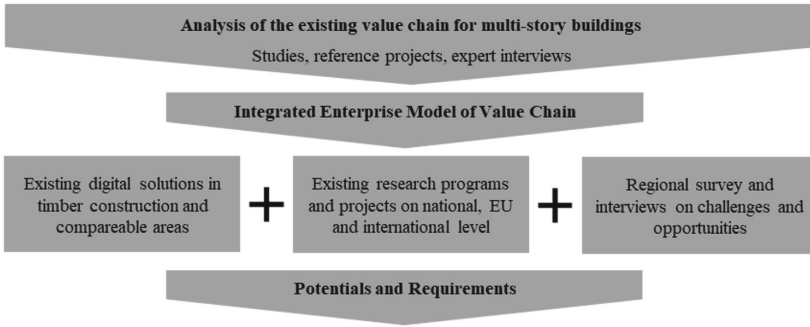


Fig. 1. Pathway of investigation.

### 3.1 Process and Digital Characteristics in Wood Construction

In contrast to conventional construction, timber construction based on prefabricated elements requires an earlier detailed examination of the construction process due to its higher degree of prefabrication. In the German-speaking countries, however, the strict separation of planning and execution is a major barrier. This is also reflected in the simplified value chain model (see Fig. 2).

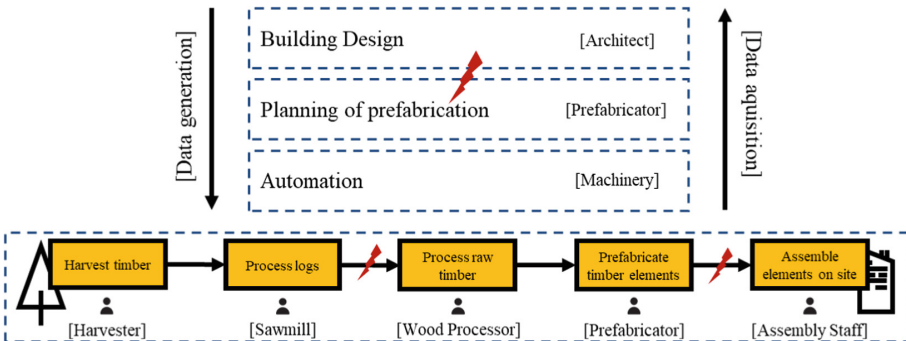


Fig. 2. Status Quo of information exchange between planning and execution.

Here, especially the vertical integration between the building design and planning of the prefabrication processes is still lacking. Approaches like leanWOOD [10] are addressing these challenges already and provide solution concepts for a more integrated planning process between the two disciplines. This way, the process can be shortened and the results optimized in terms of quality, deadlines and costs. Furthermore, an early involvement of prefabricators allows for a much more detailed consideration of company-specific solutions and supply chains, which can contribute to a better assessment and optimization of the sustainability of buildings in an early stage. Nevertheless, the implementation of the proposed approaches is still lacking.

When transferring the 2D or 3D CAD data of the architect’s design into the CAM planning of the prefabrication of the respective timber construction company, the



company-specific conditions of the production processes installed there must also be considered. The CAM data are usually based on a 3D model and serves as the source for the machine control and tool selection of CNC systems. Production-relevant aspects such as material and energy consumption, static dimensioning, element pitches, etc. can be evaluated and optimized at this stage. Afterwards, all changes in the planning are associated with high effort in the execution or omitted planning services lead to a production repetition and thus to cost-intensive delays in the construction process. [11, 12].

A continuous computer-integrated manufacturing (CIM) chain of this kind has so far hardly been realized in the construction industry, with a few exceptions [13].

A further basis for industrial prefabrication is early and precise production and work scheduling. In most cases, work scheduling centers on a virtually modeled, three-dimensional building model, which is created with a CAD-CAM program. The planning data generated in this way can be used to obtain all the information required for production and converted into two-dimensional planning documents and individual part drawings. This also includes automatic generation of bills of material, machining programs and material requirements. [14, 15].

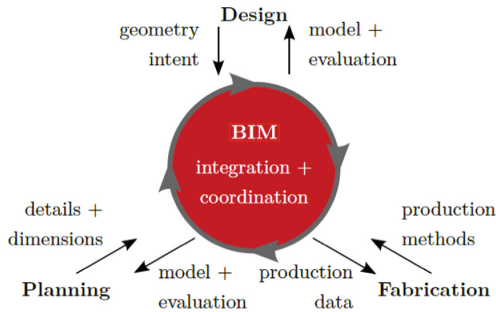
The additionally increased focus on ecological factors and its sustainability assessment, but also the desire for greater individualization is giving a significant boost to digital construction. This development calls for end-to-end information technologies for the designation of elementary data along the entire building life cycle.

## 4 The Role of BIM as an Enabler for Integration

With prefabrication, the systematization of detailed solutions is essential and inseparable from the early design phases. This necessity links modern timber construction with the BIM method, which describes a holistic approach of planning, execution and management of buildings with the help of consistent data availability. The basic idea is to digitally capture all relevant building data, link them together and, ideally, store them on a common data platform (see Fig. 3). [10, 12].

With the progressive further development and implementation of BIM along the entire value creation, the unidirectional exchange of information will be successively replaced [16]. Such a comprehensive and integrative value creation chain, in which all actors involved in planning and execution come together at an early stage of building development and explicitly align the results with the production process, corresponds to the so-called open-BIM model.

The results are brought together in a 3D model on a central data platform by means of a uniform data exchange format (e.g. Industry Foundation Classes (IFC)) and ideally linked to production-relevant data. Nevertheless, these solutions should be adaptable especially for small businesses with a hand-craft orientation. The provision of the necessary up-to-date production data represents a decisive step towards a digital integrated production. Automatic recognition of geometric properties by means of so-called “feature recognition tools” works for many standard machining operations, but is error-prone and not suitable for complex free forms. If the component geometry has been designed parametrically-associatively, this information must be made available to production via



**Fig. 3.** BIM platform for information exchange.

appropriate interfaces within the digital value creation chain. In timber construction, these are mainly CAM data formats such as “BTL” and “BVX”, which allow a machine-independent description of the geometry as well as information on machine processing. [12, 14, 17].

For this digital information flow with the integration of various data types from different stakeholders, completely in the sense of the Open-BIM approach, no suitable software is currently available. Research projects on the subject of data transfer in timber construction offer initial approaches to standardized and interdisciplinary data models. An example of the object-specific relationships of a component, in comprehensive data models, is the aggregation of information about:

- Component (e.g. material, geometry, supplier, processing etc.),
- Building (e.g. statistics, floor plans, energy management etc.),
- Material (e.g. wood origin, carbon footprint, treatments etc.).

However, in order to make optimal use of the potential of the digital value creation chain and to harmonize the various data models across different product phases, the requirements for the interface exchange still have to be defined by the timber construction companies. In this respect, the BIM method shows parallels to the fundamental concept of a digital and continuous value creation chain. [17].

## 5 Conclusion on Potentials and Requirements

The potentials of an end-to-end information exchange within the timber construction industry in Berlin/Brandenburg can be proven in many places. In this context, the greatest possible effect can be achieved not only through the cooperation of the timber construction companies themselves, but rather through a vertical as well as horizontal digital value creation chain of the entire Berlin/Brandenburg value-added (timber) construction system. The accompanying integration of the Open BIM model supports efficiency, especially in the planning and preparation process, and opens up access to excellent process models. Thus, the industrialization of the prefabrication of the wood system components with an accompanying flexible automation is an essential lever for the sustainable establishment of the wood-based materials in multi-story residential construction

in Berlin/Brandenburg. The development of regional and digital value creation chains requires networked action by all players. In order to be able to set up such value chains with trustworthy partners quickly and at low cost, common interoperable infrastructures for data exchange are a prerequisite for being able to use available data efficiently. The following table presents the main requirements in tabular form (Table 1).

**Table 1.** Digital value creation chain requirement table.

Requirements	Example
Utilize digitization	Information and material flows backed by automation solutions are only possible with digital support
Consistent joint planning	The realization of a continuous value chain in planning and construction requires cooperation between the planning actors (administration, architects/planners, specialist engineers) and the executing companies
Build regional value chains	The development of regional value chains requires networked action by all players. An integrated regional value chain can be established through horizontal and vertical cooperation
Interoperable infrastructures for data exchange	Make available data efficiently usable. The end-to-end value chain in timber construction can only be realized significantly across companies and through digital solutions
Establishment of a regional cooperation network for local businesses	In addition to the exchange of information, the objectives of the cooperation network should lie in the identification of required interfaces across companies and systems to enable a digital information exchange

With the methods of digitization, processes in the construction industry can be significantly optimized and new possibilities for individualization and traceability can be realized. For example, relevant data from prefabrication can be embedded in the end-to-end digital value chain of the wood system components and comprehensively evaluated in a life cycle analysis. The new and additional requirements for a forward-looking building culture can hardly be solved by other technologies, so that the circle to an overall ecological, economic and social sustainability is closed here.

## References

1. Churkina, G., Organschi, A., Reyer, C., Ruff, A., Vinke, K., Liu, Z., et al.: Buildings as a global carbon sink. *Nat Sustain.* **3**(4), 269–276 (2020). <https://doi.org/10.1038/s41893-019-0462-4>

2. Hafner, A., Rüter, S., Ebert, S., Schäfer, S., König, H., Cristofaro, L., et al.: Treibhausgasbilanzierung von Holzgebäuden, Forschungsbericht. Ruhr-Universität Bochum, Bochum. Fakultät Bau- und Umweltingenieurwesen (2017). [https://www.ruhr-uni-bochum.de/reb/mam/content/thg\\_bericht-final.pdf](https://www.ruhr-uni-bochum.de/reb/mam/content/thg_bericht-final.pdf)
3. Senat von Berlin:Nachhaltigkeit auf dem Bau: Berlin baut mit Holz (2019). <https://www.parlament-berlin.de/adoss/18/IIIPlen/vorgang/d18-2225.pdf>
4. Eversmann, P., Gramazio, F., Kohler, M.: Robotic prefabrication of timber structures: towards automated large-scale spatial assembly. *Constr. Rob.* **1**(1–4), 49–60 (2017). <https://doi.org/10.1007/s41693-017-0006-2>
5. Girmscheid, G.: Industrialization in Building Construction: Production Technology or Management Concept?. ETH Zurich, (2005)
6. Piller, F., Walcher, D.: Leading mass customization & personalization. LULU.COM (2018)
7. Nerdinger, W., Barthel, R., Grdanjski, M.: Wendepunkt/e im Bauen. Von der seriellen zur digitalen Architektur. Edition Detail, München (2010)
8. Stark, R., Seliger, G., Bonvoisin, J. (eds.): SPLCEM, Springer, Cham (2017). <https://doi.org/10.1007/978-3-319-48514-0>
9. Spur, G., Mertins, K., Jochem, R.: Integrated enterprise modelling, 1st edn. Developments for the standardization of CIM. Beuth Verlag GmbH, Berlin (1996)
10. Lattke, F., Hernandez-Maetschel, S.: Leanwood - advancing performance of design teams in timber construction. In: Proceedings of the World Conference on Timber Engineering, Vienna, Austria (2016)
11. Kaufmann, H., Krötsch, S., Winter, S.: Manual of Multistorey Timber Construction. Detail (2018)
12. Svilans, T., Tamke, M., Thomsen, M.R.: Integrative strategies across the digital timber value chain. In: Hvejsel MF, Cruz PJS (eds) Structures and Architecture. A Viable Urban Perspective?: Proceedings of the Fifth International Conference on Structures and Architecture (ICSA 2022), Aalborg, Denmark, 6–8 July 2022. CRC Press, Boca Raton (2022)
13. Rhombert, H.: Construction 4.0: the lifecycle tower and digitalised timber construction. In: Lehmann, H. (ed.) Factor X. EIS, vol. 32, pp. 373–384. Springer, Cham (2018). [https://doi.org/10.1007/978-3-319-50079-9\\_26](https://doi.org/10.1007/978-3-319-50079-9_26)
14. Slepicka, M., Vilgertshofer, S., Borrmann, A.: Fabrication information modeling: closing the gap between building information modeling and digital fabrication. In: ISARC Proceedings of the International Symposium on Automation and Robotics in Construction, pp. 9–16. IAARC Publications (2021)
15. Tamke, M., Gatz, S., Svilans, T.: Tree-to-product : prototypical workflow connecting data from tree with fabrication of engineered wood structure - RawLam. In: Proceedings of World Conference on Timber Engineering: WCTE2021, pp. 2754–2763 (2021)
16. Geier, S., Schwehr, P.: Criteria catalogue and analysis model to manage complexity in prefabricated timber construction. *IOP Conf. Ser.: Earth Environ. Sci.* **323**, 12046 (2019)
17. Müller, F., Jaeger, D., Hanewinkel, M.: Digitization in wood supply – a review on how Industry 4.0 will change the forest value chain. *Comput. Electr. Agric.* **162**, 206–218 (2021)

**Open Access** This chapter is licensed under the terms of the Creative Commons Attribution 4.0 International License (<http://creativecommons.org/licenses/by/4.0/>), which permits use, sharing, adaptation, distribution and reproduction in any medium or format, as long as you give appropriate credit to the original author(s) and the source, provide a link to the Creative Commons license and indicate if changes were made.

The images or other third party material in this chapter are included in the chapter's Creative Commons license, unless indicated otherwise in a credit line to the material. If material is not included in the chapter's Creative Commons license and your intended use is not permitted by statutory regulation or exceeds the permitted use, you will need to obtain permission directly from the copyright holder.





# Smart Manufacturing Systems for Small Medium Enterprises: A Conceptual Data Collection Architecture

M. G. Kanakana-Katumba<sup>1</sup>, R. W. Maladzi<sup>2</sup>, and M. O. Oyesola<sup>1</sup>(✉)

<sup>1</sup> Tshwane University of Technology, Startartellarie Road, Pretoria 0001, South Africa  
{kanakanamg, oyesolamo}@tut.ac.za

<sup>2</sup> University of South Africa, 28 Pioneer Street, Johannesburg 0111, South Africa  
maladrw@unisa.ac.za

**Abstract.** Smart manufacturing is the future of sustainable manufacturing entities with the emergence of innovative technologies readily available to foster industrial production. It becomes imperative for Small Medium-sized Enterprises (SMEs) to adopt the initiatives of the fourth industrial revolution termed Industry 4.0, to improve productivity and efficiency. SMEs are vital for the economic growth and social transformation of any nation, as such incorporating emerging technologies would generate more revenue and support sustainability. One of the major challenges facing the SMEs in a competitive and dynamic manufacturing environment is adapting the technique and implementation of smart enabled systems. The current manufacturing data information architecture for smart manufacturing is premeditated for big organisations with funding and skills to implement such systems, however SMEs struggles to cope with such advancement. This paper aim to propose a concept based data collection architecture to aid SME using the systems of smart manufacturing for internetwork communication, prediction and analysis. This study proposes a conceptual data architecture framework, which SMEs can utilise for data collection and integrate into any type of small-scale industrial production settings to enable effective decision-making. The successful demonstration of the concept is to gear manufacturing SMEs towards smart systems with no-need for high-level implementation techniques.

**Keywords:** Manufacturing system · System architecture · Conceptual design

## 1 Introduction

Data collection is critical in a manufacturing system. The ability to collect accurate data in an affordable manner is important to an enabling appropriate decision making. Small medium sized enterprises (SMEs) lack the funds required to collect accurate data in real-time; hence poor planning and productivity [1]. The ability to collect, analyse and communicate data through an affordable technique is crucial to any organisation. Globally, smart manufacturing is getting recognised as a value adding technique with the introduction of the fourth industrial revolution [2]. The SMEs that are readily flexible

and agile stand to benefit immensely from adoption and implementation of data collection architecture. For this reason, effective data collection structure is necessary. Smart Manufacturing Systems (SMS) defines the view of predictive tool, decision devising, and susceptibility to ubiquitous information from big data environments to help manufacturing enterprises better predict, balance production and improve efficiency and productivity [3].

SMS pronounces the merging of the digital and physical worlds within the manufacturing setting [4]. The National Institute of Standards and Technology (NIST) defines smart manufacturing as “fully-integrated, collaborative manufacturing systems that respond in real time to meet changing demands and conditions in the factory, in the supply network, and in customer needs” [5]. Smart manufacturing is characterised by digitalisation and service-orientation, connected and autonomous cyber physical system (CPS) objects, collaborative supply networks, integrated and decentralised decision-making, interoperability and advanced analytics [6]. It is considered as a new paradigm that carries the convergence of the cutting-edge information and communications technology (ICT) and manufacturing technologies. The added advantage of meeting the personalised customers’ needs rather than only completing the manufactured products will intensify customers’ interest [9]. Thus, SMS is estimated to be far more capable than usual manufacturing processes [10]. Industry 4.0 gives a boost to computer-integrated manufacturing (CIM), allowing a more decentralised architecture based on Customer Premises Network (CPN) [11]. Internet of Things (IoT) allows integrating devices and equipment into the company’s information system infrastructure [12]. While Industry 4.0 tools enhances Machine to Machine (M2M) communication [13], CIM was initially developed with a focus on human employees [14]. This includes self-organised diagnostics and repair request communicated to machine and equipment suppliers and allowing smart and intelligent predictive maintenance (SIPM) [15]. Components within the Industry 4.0-framework act as autonomous agents [16]. The transition from usual manufacturing towards smart manufacturing usually passes through the stages of connected (computerisation and connectivity), transparent (visibility and transparency), and intelligent (predictive capacity and adaptability [17].

Big data plays a key role in SMS, as big data is used for manufacturing operations’ optimisation, efficient planning and control, predictive supply, fault diagnosis, asset utilisation, and risk assessment [18]. Implementation of data science for SMS can be achieved through four enabling technical approaches; these include Data Technology (DT), Analytic Technology (AT), Platform Technology (PT) and Operations Technology (OT) [19]. Data-driven can be utilised in manufacturing, however, the conceptual model to implement such is required. Therefore, this paper pushes for a simple effective framework to structure data for the benefit of SMEs to ensure competitiveness.

## 2 Literature Review

Enterprise architecture is defined as a model organization use to design and implement information, technology, infrastructure and systems [21]. Enterprise data architecture in this study refers to the design and implementation of a data collection system for SME. Data collection is a costly exercise and manufacturing should provide cost-effective, sustainable, and safe manufacturing. [22]. The ability to collect data effectively requires enterprises to invest in data collection tools and systems. Many SMEs do not have the funds to invest in such resources; hence, their organisation suffer from low productivity and efficiency [20]. Industry 4.0 has opened the opportunity for organisations to take advantage of the internet of things, big data technology, and cloud computing without investing a significant amount of resources and skills required to design such systems. Data collection architecture proposed by multi-level integration is intended for large industries [20]. Utilising data collection tools linked to cloud hosting can have SMEs manufacturers to make decisions based on data, hence improving the business's operations. There is an extensive definition of smart manufacturing, according to Wallace and Riddick [23]. Smart manufacturing is described as a concentrated data application of information technology at the shop floor level and above to enable intelligent, efficient, and responsive operations [23]. The highlight concerning SM is the use of advanced data analytics to improve manufacturing operations at all levels of network, from shop floor, factory, supply chain, with the aid of information and communication technology (ICT) [24]. Some authors extended the knowledge of the smart manufacturing framework beyond the perception of manufacturing, but to all-round life cycle data management [25]. Based on the past research, review relating to data architecture designed is conducted in this section to specifically conceptualise for a low-level SMEs.

### 2.1 Smart Manufacturing Systems of Industry 4.0

Smart manufacturing is a data-driven connected network of a number of integrated technologies such as cloud computing, cyber-physical production systems (CPPS), internet of things (IoT), robotics/automation; all these are suitable for SMEs adoption [12]. The technology roadmap and changes in manufacturing paradigms are categorised into three basic levels [12]:

1. Information and communication technology (ICT): Computer network – Internet; Information space – World Wide Web (WWW or the Web); Agent technology; Mobile technology (communication protocol); Cloud technology; Internet of Things; Big data; etc.
2. Manufacturing technologies: Machining techniques – Computer Numerical Control (CNC); additive manufacturing – 3D printing; Reconfigurable machine tools; etc.
3. Artificial intelligence (AI): Computer & computing techniques; Cognitive technology – software-based; Computer-aided Diagram/Manufacturing (CAD/CAM), Enterprise Resource Planning (ERP), etc.; Robotics techniques – industrial robots, etc.; Virtual techniques; etc.



## 2.2 Benefit of Smart Manufacturing and Data Analytics

Post pandemic effect changes the way business is done globally, according to Almeida et al [24], 24% of businesses felt the urge to invest more in digital workflow and optimized automation technologies while 18% of companies expect to spend more on data analytics tools. The increase in fluctuating demands from customers throughout the entire manufacturing operations necessitate real-time response by the manufacturers, SMEs inclusive. Data in manufacturing is no longer a choice; it is now the required tool to help SME stay competitive in the vast manufacturing market. An architecture methodology proposed in [24] described work outlines for the integration of data collection tools, in-house manufacturing systems, and cloud computing to enable smart manufacturing systems with artificial intelligence (AI). However, the small manufacturing ventures are yet to utilize the full advantage of data analytics for efficient use.

## 2.3 Big Data Informatics for Small Medium Enterprise

The consideration of business informatics according to industry 4.0 principles, SME companies need to tackle two factors to remain active [18]: (i) analytical tools that can accurately capture and predict consumer patterns, and (ii) an automated closed-loop feedback system that can intelligently inform business processes to respond to changes in real-time based on the inputs received (data trends, user experience, etc.). Simplified big data value chain includes at least 4 stages [18]:

1. Data sources, during the data-generation stage, a stream of data is created from a variety of sources: sensors, human input, etc.
2. The raw data is combined with data from other sources, classified, and stored in some data repository.
3. Algorithms and analytics are applied by an intelligence engine to interpret and provide utility to the aggregated data.
4. The outputs of the intelligence engine are converted to tangible values, insights, or recommendations.

The opportunities for sustainable smart manufacturing environments from a macro and micro perspective, these efficient data managements are pinned on: business models, value-creation network, products and processes [21, 24]. Table 1 present a summary of smart manufacturing approaches useful for SME adoption.

**Table 1.** Summary of smart manufacturing and scope of SME adoption.

Key smart interaction models	Main usage of smart technologies for SME	Authors/year
Cloud computing and automation systems	<ul style="list-style-type: none"> <li>- Concept on cloud computing technology for industrial automation</li> <li>- Architecture to improve information flow, control, reliability and real-time issues</li> </ul>	[25]
Big data environment (Advanced analytics)	<ul style="list-style-type: none"> <li>- Assembly lines highly automated and intelligent systems to handle data, self-aware control machines</li> <li>- Manufacturing and big data prediction to achieve high productivity</li> </ul>	[25]
Smart factory and decentralised manufacturing	<ul style="list-style-type: none"> <li>- Enabling technology involving the concepts of embedded systems, communication technology (wireless), automatic identification technologies, situation recognition (sensor fusion)</li> <li>- Context-aware production systems and real-time</li> </ul>	[26]
Networked control systems (advanced sensor)	<ul style="list-style-type: none"> <li>- Sensor technologies and integration of knowledge aim to increase the transformation of the factory</li> <li>- Implementation of state of the art networked control systems for stabilizing linear systems, network topology, and event-based energy efficiency</li> </ul>	[27]
Advanced robotics	<ul style="list-style-type: none"> <li>- Stronger adoption of advanced robotics technology is reckoning in automotive; SMEs can use it for autonomous activities</li> <li>- Usage of robotics is mostly assumed an high level technology but very useful in automation when compared manpower equal labour cost</li> </ul>	[28]
Additive manufacturing (3D printing)	<ul style="list-style-type: none"> <li>- No widespread adoption of 3D printing by the SMEs in value adding and understanding manufacturing problems better</li> <li>- 3D printing for low-level or customise and scalable production entry opportunities</li> </ul>	[30]

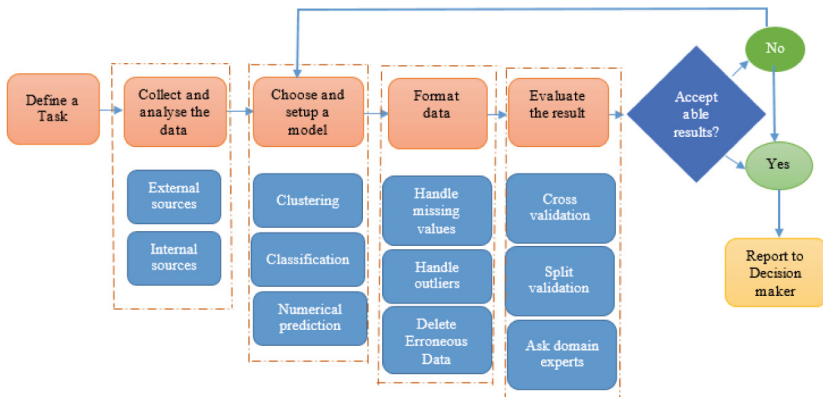
*(continued)*

**Table 1.** (continued)

Key smart interaction models	Main usage of smart technologies for SME	Authors/year
IT skills and training	- Generally, software/digital skills are needed to support the smart move towards industry 4.0; combination of Internet of Things talent, business intelligence and fundamental education for IT skills	[31]

### 3 Methodology

Manufacturing system architecture demonstration is subjective to enterprise requirements. As such, researcher seeks to design a conceptual data collection architecture for SME to manage; thereby becoming efficiently smart in manufacturing. The usual knowledge about data analysis process follows the cross industry standard process for data mining (CRISP-DM). The concept known as CRISP-DM approach is the basis set for data mining and useful for entry level of manufacturing ventures, adopted [33] (see Fig. 1).



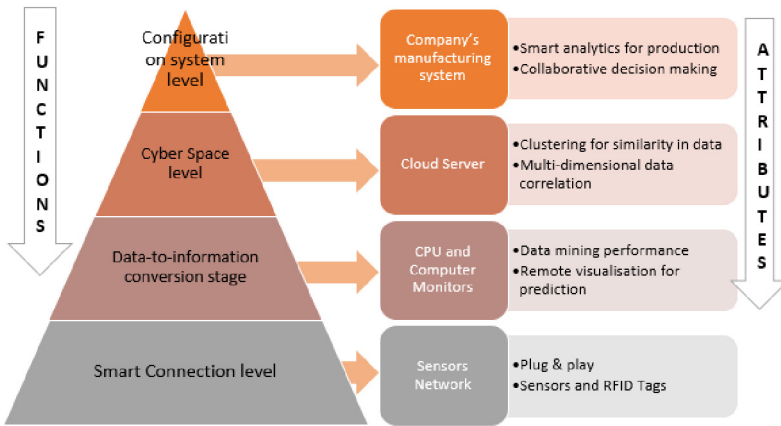
**Fig. 1.** Cross industry standard process for data mining (CRISP-DM).

CRISP-DM approach introduces standard phases for data science in business, namely;

- Business understanding
- Data understanding
- Data preparation
- Modelling
- Evaluation
- Utilization

To demonstrate an effective Data Enterprise Architecture (DEA) solution, the research partner with an SME to solve basic real life manufacturing problem; a conceptual solution was developed after point and dot assessment. The DEA application focused on productivity record and reduction of downtime as a problem to be solved.

In order to project a cognitive DEA solution, the use of database roles was conceptualized to form a broader flowchart inter-network based on functions and attributes. The attributes are in line with the company’s character (a small-scale textile venture), starting with the process production configuration sub-divided into functions. An encompassing data collection architecture was conceptualised for the SME smart manufacturing users. This was done to ensure that there is a control of what to use in an appropriate environment and get the targeted results. The data architecture structure conceptualized in this study to attain a smart system phase is presented in Fig. 2.



**Fig. 2.** Data Architecture for implementing data analytics

With smart manufacturing system, real time information is essential. Thus, the function and attributes of decomposable data capturing architecture on the bases of SME venture understanding, model, network and configuration is denoted. This concept premised on basic intelligent system using cell sensor, external server, and internal database for data analysis and prediction. The structure is to allow enterprise to collect data, analyse, and decide on the functioning of the manufacturing decision, continuity, quality of products and digital order.

#### 4 Conclusion

Unambiguously smart enabled manufacturing has been critically viewed as a tool for the SMEs to thrive in the competitive business market. A small and medium-sized venture will benefit more through the adoption of smart technologies to improve product quality, reduce lead times, reduce overtime, better cost estimation, increasing throughput, improving productivity, minimising work-in-process and better production planning

among others. Among these operational benefits, decision making with appropriate and precise information is crucial in achieving the aforementioned benefits. As such, this study had proposed a data architecture for SME smart manufacturing approach; this is different in a sense that it is simple, and it is a design-fit-all for any person without extensive skills to implement. SME in nature are hesitant to adopt technology, this architecture is designed to ensure that it is easy for the middle-sized manufacturing sector to adopt thereby leading to technology diffusion. Recommendation for this study on the long term includes management activities with respect to manufacturing enterprise execution and implementation with regards to specific small scale ventures. This contribute to closing gaps encountered and the acquisition and implementation of information systems and technology.

## References

1. Mittal, S., Khan, M.A., Romero, D., Wuest, T.: A critical review of smart manufacturing & Industry 4.0 maturity models: Implications for small and medium-sized enterprises (SMEs). *J. Manuf. Syst.* **49**, 194–214 (2018)
2. Geissbauer, R., Vedso, J., Schrauf, S.: *Industry 4.0: building the digital enterprise*, PWC 2016 (2017)
3. Lenz, J., MacDonald, E., Harik, R., Wuest, T.: Optimizing smart manufacturing systems by extending the smart products paradigm to the beginning of life. *J. Manuf. Syst.* **57**, 274–286 (2020)
4. Kavakli, E., Buenabad-Chávez, J., Tountopoulos, V., Loucopoulos, P., Sakellariou, R.: WiP: an architecture for disruption management in smart manufacturing. In: 2018 IEEE International Conference on Smart Computing (SMARTCOMP), pp. 279–281. IEEE (2018)
5. Moghaddam, M., Marissa, N., Cadavid, C., Kenley, R., Deshmukh, A.V.: Reference architectures for smart manufacturing: s critical review. *J. Manuf. Syst.* **49**, 215–225 (2018)
6. Lu, Y., Morris, K.C., Frechette, S.: Current standards landscape for smart manufacturing systems. National Institute of Stand. Technol. NISTIR **8107**, 39 (2016)
7. Frustaci, M., Pace, P., Aloï, G., Fortino, G.: Evaluating critical security issues of the IoT world: present and future challenges. *IEEE Internet Things J.* **5**(4), 2483–2495 (2017)
8. Tuptuk, N., Hailes, S.: Security of smart manufacturing systems. *J. Manuf. Syst.* **47**, 93–106 (2018)
9. Wilkesmann, M., Wilkesmann, U.: Industry 4.0 – organizing routines or innovations? *VINE J. Inf. Knowl. Manag. Syst.* **48**(2), 238–254 (2018). <https://doi.org/10.1108/VJIKMS-04-2017-0019>
10. Chen, G., Wang, P., Feng, B., Li, Y., Liu, D.: The framework design of smart factory in discrete manufacturing industry based on cyber-physical system. *Int. J. Comput. Integr. Manuf.* **33**(1), 79–101 (2020)
11. Weyrich, M., Schmidt, J.-P., Ebert, C.: Machine-to-machine communication. *IEEE Softw.* **31**(4), 19–23 (2014)
12. Pacchini, A.P.T., Lucato, W.C., Facchini, F., Mummolo, G.: The degree of readiness for the implementation of Industry 4.0. *Comput. Ind.* **113**, 103125 (2019). <https://doi.org/10.1016/j.compind.2019.103125>
13. Pech, M., Vrchota, J., Bednář, J.: Predictive maintenance and intelligent sensors in smart factory. *Sensors* **21**(4), 1470 (2021)
14. Pereira, A.C., Romero, F.: A review of the meanings and the implications of the Industry 4.0 concept. *Procedia Manufacturing* **13**, 1206–1214 (2017). <https://doi.org/10.1016/j.promfg.2017.09.032>

15. Tao, F., Qi, Q., Liu, A., Kusiak, A.: Data-driven smart manufacturing. *J. Manuf. Syst.* **48**, 157–169 (2018)
16. Liu, Q., Wang, Z., Liu, M.: HCPS-driven intelligent network collaborative manufacturing mode of process industry and open architecture of intelligent enterprise. *IFAC-PapersOnLine* **53**(5), 140–145 (2020)
17. Wang, J., Xu, C., Zhang, J., Zhong, R.: Big data analytics for intelligent manufacturing systems: a review. *J. Manuf. Syst.* (2021)
18. Gorkhali, A., Xu, L.D.: Enterprise architecture: a literature review. *J. Ind. Integr. Manage.* **2**(02), 1750009 (2017)
19. Van Nguyen, T., Zhou, L., Chong, A.Y.L., Li, B., Pu, X.: Predicting customer demand for remanufactured products: a data-mining approach. *European J. Oper. Res.* **281**(3), 543–558 (2020)
20. Lu, Y., Xu, X., Wang, L.: Smart manufacturing process and system automation—a critical review of the standards and envisioned scenarios. *J. Manuf. Syst.* **56**, 312–325 (2020)
21. Zhong, R.Y., Xun, X., Klotz, E., Newman, S.T.: Intelligent manufacturing in the context of industry 4.0: a review. *Engineering* **3**(5), 616–630 (2017)
22. Ren, S., Zhang, Y., Liu, Y., Sakao, T., Huisingh, D., Almeida, C.M.: A comprehensive review of big data analytics throughout product lifecycle to support sustainable smart manufacturing: a framework, challenges and future research directions. *J. Clean. Prod.* **210**, 1343–1365 (2019)
23. Almeida, F., Santos, J.D., Monteiro, J.A.: The challenges and opportunities in the digitalization of companies in a post-COVID-19 world. *IEEE Eng. Manage. Rev.* **48**(3), 97–103 (2020)
24. Castelo-Branco, I., Cruz-Jesus, F., Oliveira, T.: Assessing industry 4.0 readiness in manufacturing: evidence for the European Union. *Computers in Industry*, 107, 22–32 (2019)
25. Pei Breivold, H.: Towards factories of the future: migration of industrial legacy automation systems in the cloud computing and Internet-of-things context. *Enterprise Inf. Syst.* **14**(4), 542–562 (2020)
26. Delsing, J.: Local cloud internet of things automation: technology and business model features of distributed internet of things automation solutions. *IEEE Ind. Electron. Mag.* **11**(4), 8–21 (2017)
27. Moyne, J., Iskandar, J.: Big data analytics for smart manufacturing: case studies in semiconductor manufacturing. *Processes* **5**(3), 39 (2017)
28. Rauch, E., Dallasega, P., Matt, D.T.: Distributed manufacturing network models of smart and agile mini-factories. *Int. J. Agile Syst. Manage.* **10**(3–4), 185–205 (2017)
29. Oyesola, M., et al.: Sustainability of Additive Manufacturing for the South African aerospace industry: a business model for laser technology production, commercialization and market prospects. *Procedia CIRP* **72**, 1530–1535 (2018)
30. Guzmán, V.E., Muschard, B., Gerolamo, M., Kohl, H., Rozenfeld, H.: Characteristics and skills of leadership in the context of industry 4.0. *Procedia Manuf.* **43**, 543–550 (2020). <https://doi.org/10.1016/j.promfg.2020.02.167>
31. Saeed, T.: Data mining for small and medium enterprises: a conceptual model for adaptation. *Intell. Inf. Manag.* **12**(05), 183 (2020)

**Open Access** This chapter is licensed under the terms of the Creative Commons Attribution 4.0 International License (<http://creativecommons.org/licenses/by/4.0/>), which permits use, sharing, adaptation, distribution and reproduction in any medium or format, as long as you give appropriate credit to the original author(s) and the source, provide a link to the Creative Commons license and indicate if changes were made.

The images or other third party material in this chapter are included in the chapter's Creative Commons license, unless indicated otherwise in a credit line to the material. If material is not included in the chapter's Creative Commons license and your intended use is not permitted by statutory regulation or exceeds the permitted use, you will need to obtain permission directly from the copyright holder.





# Key Enablers of Industry 5.0 - Transition from 4.0 to the New Digital and Sustainable System

Maja Trstenjak<sup>(✉)</sup>, Miro Hegedić, Nataša Tošanović, Tihomir Opetuk, Goran Đukić, and Hrvoje Cajner

Faculty of Mechanical Engineering and Naval Architecture, University of Zagreb, Ivana Lučića 5, 10 000 Zagreb, Croatia  
maja.trstenjak@fsb.hr

**Abstract.** As Industry 4.0 has reached its first decade the new concept has appeared in the literature - Industry 5.0. With an emphasis on human role with the digital system, Industry 5.0 emphasizes the aspects of environmental awareness and sustainability in focus which serves as an upgrade to the previously presented concept. Although Industry 4.0 hasn't yet been implemented at the expected level in manufacturing companies all around the globe, this paper studies the current trends in Industry 5.0, the transition from 4.0 to 5.0 or directly to 5.0 by current evidence from the literature.

Based on the given extensive literature review, this paper provides a list of key enablers of Industry 5.0, possible directions of its development, influential transitional criteria, its advantages, and barriers.

**Keywords:** Industry 5.0 · Digital transformation · Sustainability · Flexible manufacturing

## 1 Introduction

Industry 4.0 has passed its first decade, but its full implementation by the strategic plans of many countries then presented, hasn't occurred yet [1]. The demand for flexible and agile manufacturing has increased even more over the years, as the world faced many unexpected challenges, as Covid-19 pandemic, for example. The high demand changed behavior of customers and restrictions have caused disruptions in supply chains when the industry hasn't yet implemented a fully functioning solution [2]. This is where the latest digital technologies play an important role to avoid the unnecessary and unpleasant increase of cost and time loss. Industry 4.0 has provided a background for the manufacturing digitalization resulting in a flexible and self-optimizing system which can provide answers for the dynamic market in relatively short time [3].

The pathway from the traditional to digital manufacturing demands complex changes on many level that also require a high initial investment which can be very challenging, especially for the small and medium enterprises. Therefore, many researchers have



dealt with the barriers which disable the transition towards Industry 4.0. One of the most common is the lack of knowledge about the digital principles which causes the inability to be aware of the future benefits which provides the potential higher initial investment in the new technologies. Second is the lack of human skills and knowledge which would enable the proper functioning of the digital system which requires the new skills and human positions for which the special internal trainings and education that must be provided, because the traditional academic structure hasn't yet incorporated this on the needed level [4]. This also causes the fear of human job loss because most of the manual tasks are now automatized and no longer require a human worker. To avoid these obstacles, before the Industry 4.0 technology implementation the strategic transformational plan should be defined for the optimal transition which maximizes the future benefits and minimizes the transitional time and cost [5].

To avoid obstacles of Industry 4.0 implementation, to give a response on the new market and global society trends, but also the improve the workers' life quality and enable the sustainability of the system, concept of Industry 5.0 is presented as a green and sustainable step further for the digital manufacturing systems [6]. As a relatively new concept, in the next chapters the literature review of the currently published papers will be given to explain the Industry 5.0 concept, based on which the most important characteristics of Industry 5.0 will be singled out, and key enablers will be defined as a guidance for the optimal transition from 4.0 to 5.0.

## 2 Industry 5.0

The first records of Industry 5.0 have been mentioned in 2017, and beside the digital transition the green component of a system plays an important role. Principles of Industry 5.0 must not only impact the single company but influence the entire society. The European Union states that Industry 5.0 "It places the wellbeing of the worker at the center of the production process and uses new technologies to provide prosperity beyond jobs and growth while respecting the production limits of the planet" [7]. Therefore it "complements the existing "Industry 4.0" approach by specifically putting research and innovation at the service of the transition to a sustainable, human-centric and resilient European industry". This kind of concept benefits not only the industry but also the worker as an individual and entire society. It creates a more resilient system to external changes and shocks with also a "greener" approach as another characteristic.

### 2.1 Literature Review

The most relevant scientific database *Web of Science* has been searched by tag "Industry 5.0" and most interesting and important work found will be described in following.

Xu et al. (2021) have stated that the main difference between the Industry 4.0 and 5.0 is that the 4.0 is technology driven, while 5.0 is value driven. They find EU directive as the main enabler of the 5th industrial revolution with three core values of manufacturing (human-centricity, sustainability, and resilience) and six enabling technologies (individualized human-machine interaction, bio-inspired technologies, digital twins, artificial intelligence and technologies for energy efficiency) [8]. Dautaj & Rossi (2021) have

compared the Industry 5.0 with the Society 5.0 concept [6], similarly to Salimova et al. (2020) [9]. Therefore, the changes and improvement should happen on every level of the community. Nahavandi (2019) discussed Industry 5.0 as a human-centric solution where the productivity is being increased without removing human workers from the process. Importance and challenges of collaborative robots are mentioned with a conclusion that Industry 5.0 will generate even more human work opportunities [10]. Akundi et al. (2022) discussed the human coexistence with the robots as one of the important research priorities [11] while Lu et al. (2022) discuss wellbeing principles in workplace design and organization as one of the key components of Industry 5.0, following the “5C” map of human-machine relationship: “Coexistence, Cooperation and Collaboration to future Compassion and Coevolution” [12]. The similar approach have Kaasinen et al. (2022) who discuss the teamwork collaboration in human-machine relations [13]. That is why Longo et al. (2020) discuss the implementation of value-oriented and ethical technology engineering in Industry 5.0 environment [14]. Doyle-Kend & Kopacek (2021) discussed an adoption of collaborative robots in Industry 5.0 which say will play an important role at 5th industrial (r)evolution, while on the case study of Irish industry showed that there are signs of awareness of importance of their implementation and benefits for the manufacturing [15]. Dimitropoulous et al. (2021) presented a framework of a of an AI-based system for the modular manufacturing comprised of three modules. These modules enable capturing the operator and environment status and process status, identification of the tasks that are being executed by the operator using vision-based machine learning, and provision of customized operator support from the robot side for shared tasks [16]. This kind of system was developed because for mass customizatoin concept demands which caused various bottlenecks in the system and so the usage of wearable devices enhanced with AI in support the interaction of human operators with robots in human-robot collaborative environments in a seamless and non-intrusive way [17].

Javaid et al. (2020) see the benefits of the Industry 5.0 in pandemic outbreaks, as an useful tool to help doctors and medical students to get needed training, but also with the remote monitoring systems in a healthcare [18]. The 5.0 principles can improve the hospitality sector where the interaction between the human and technology can improve the hygiene levels which are of highest importance today in the hospitality sector, claim Pillai et al. (2021) [19]. Javaid & Haleem (2020) concluded that the Industry 5.0 provides higher accuracy and speeds up manufacturing automation with help of critical thinking of human resources [20]. Majernik et al. (2022) studied the sustainable development from Industry 4.0 to 5.0. Significant progress in automation, robotization and digitization which supports the economic growth which is in relationship with sustainable development and climate strategies is noticed, as one of the key goals of Industry 5.0 [21]. Alvarez-Aros & Bernal-Torres (2021) claim that the technological competitiveness and emerging technology are key factors of the organizational strategy for the transition from 4.0 to 5.0. They mention engineering skills as one of the most important competencies as well as the training and education with sustainable organizational approach [22]. Broo et al. (2022) also see high importance in skills and suggests the rethinking of the engineering education by four strategies: “lifelong learning and transdisciplinary

education (1), sustainability, resilience, and human-centric design modules (2), hands-on data fluency and management courses (3) and human-agent/machine/robot/computer interaction experiences (4)” [23]. Matsuda et al. (2019) claim that the introduction and penetration of 5G network will bring significant technological advancements while the changes also must happen not only on the technological, but also the organizational and managerial level so that the theoretical background of the new concept can be fully implemented [24]. Özdemir & Hekim (2018) noticed the flaws of “extreme automation” which cause certain risks, where they see Industry 5.0 as a pathway to democratize knowledge and increase innovation and security level [25]. The innovation in the Industry 5.0 era and its importance was also discussed by Aslam et al. (2020) who see it as an important point for competitiveness on the market where, by digital standards, the special innovation management systems should be implemented within the companies [26]. Sharma et al. (2022) have shown a result of a research in German pharmaceutical manufacturing sector where the highest importance for the Industry 5.0 implementation was given to “linking virtual reality and reality” [27].

## 2.2 Key Enablers of Industry 5.0

Based on previously presented theoretical overview of the Industry 5.0 concept in the relevant literature there are several key points which stand out and distinct the transition from the 4.0 to 5.0 and can be used as a key enablers for the Industry 5.0 implementation. Those can be designated in two groups - human-centered approach and environmental impact awareness. These two groups have one thing in common - the achievement of sustainable system. Each of the main component brings many advantages to the manufacturing system, but also generates certain barriers, which will be described in the following.

**Human Centered Approach.** After the Industry 4.0 initiated complete digitization and automation of repetitive human work it created one of the greatest barriers in its implementation. The truth is that the many professions could disappear because of the work automatization, but the need for the human resources remains as one of the most important components of the industry. That is why Industry 5.0 places human in the center of the system and understands human knowledge and skills as one of most treasurable resources and competitive advantages. The local governments have recognized the need of the new-skilled professionals from the digital technologies which is why the educational system is also facing many changes. Today there are more examples of learning factories which are, usually, part of the academic institutions, but used not only for the education of the students, but also the education of working professionals which accept the concept of life-long learning and improvements.

**Flexibility and Modularity.** Unexpected global crisis and supply chain interruptions also caused that the modularity and flexibility of the system has become one of the most important goals of manufacturing companies. Another trend which emphasizes the need for the flexibility is the customization of the product which leads to significant product variation with the little time for the production preparation and planning. This can be achieved on the software level by advanced systems (digital twin) which control and

adapt the hardware (machines, robots, etc.) which is often referred as self-optimization. One of the hardware solutions which enable flexibility are collaborative robots which are cost-effective, safe and flexible.

**Human Factors, Ergonomics, Well-Being and Ethical Technology.** The special focus in Industry 5.0 is given to interaction between human and machine which can also partially be understood as sequel to use of collaborative robots. The ergonomics standards and measuring can be also implemented in the digital twin but also there is an increased need for use of specialized ergonomic software such as Siemens Jack, Ergo-Plus, VelocityEHS or SHERPA Software. Worker motivation is also one of the key components of Industry 5.0 which can be increased not only by ergonomic design of a workplace but also with implementation of wellbeing principles in the work environment. The wellbeing principles can improve workers' health and minimize the impact of stress-related psychosomatic diseases which lead to the absence of the workers from the workplace. With increased use of artificial intelligence, the certain ethical concerns have been raised. This includes the use and distribution of collected data, safety issues related to cybercriminal and safety of workers. The points for the trustworthy and ethical technology must not only be discussed and implemented on the industrial level, but also on the higher level of legislative bodies.

**Innovation Management.** Innovation is one of the leading advantages of every company which increases the market competitiveness. The need for the system flexibility and adjustment to the demands needs of the market has set the innovation management as one of the most important organizational key points of the Industry 5.0 concept. This includes special management of the organization's innovation procedure in which human workers from each organizational level must be included in. The set of tools which allow workers to better understand the processes and internal goals can be extended part of research & development department, all in hand to reduce production costs, increase product quality and shorten time-to-market.

**Green and Sustainable Manufacturing.** With the increase of climate preservation and reduction of the general pollution, green technologies have become a one of the most important in every aspect of human life, as well as the industry. The use of sustainable energy sources and increase of energy efficiency is another point to be achieved with Industry 5.0 and the use of advanced technology enables the adequate transition towards green standards and its optimization in exploitation phase. This is also closely related to the circular economy concept which encourages the material and product recycling and reuse to reduce the waste, maximize the usability and minimize the malicious environmental impact. This is all needed to achieve sustainable system in the end which won't be subject to unexpected market changes or disruptions and to enable the implementation human-centered flexible system.

### 3 Conclusion

Industry 5.0 is a natural development and advancement of previously presented digital manufacturing concept Industry 4.0. The human-centered approach enables the avoidance of human job loss because of the intensive digitalization, while use of artificial

intelligence enables the flexible and modular manufacturing by rising trend of personalized products and dynamic and unstable market demands. Industry 5.0 is environmentally aware, the increase of energy efficiency and use of renewable energy sources leads to positive impact to global demands for manufacturing industry. Industry 4.0 has demanded drastic digital transformation of very high investment and unclear future benefits; therefore, its implementation hasn't always been provided at fullest. Today, with the raised awareness of digital technologies and unexpected global events which has caused the disruptions of supply chains, but also the impacts of climate change, the human is more determined to start the digital transformation, while being sure that they are one of most important resources in the value chain.

For the future work, based on the specific Industry 5.0 characteristics previously mentioned, the adequate decision support method for the readiness calculation could be chosen and the model developed. This would enable the definition of transformational strategic plan for the optimal digital technology implementation and organizational changes.

**Funding.** This research was funded by the European Regional Development Fund, grant number KK.01.2.1.02.0226, "Razvoj energetske visokoučinkovite sustave za zagrijavanje na kruta goriva iz obnovljivih izvora energije korištenjem inovativnih tehnoloških postupaka".

## References

1. Weng, J., Wei, F., Jaiswal, A., Noche, B.: A review of industry 4.0 on national level and a concept of industry 4.0 stages based on technical level. In: Proceedings - 17th Annual International Conference on Distributed Computing in Sensor Systems, DCOS 2021, pp. 252–258 (2021). <https://doi.org/10.1109/DCOSS52077.2021.00049>
2. Duong, A.T.B., Vo, V.X., do Sameiro Carvalho, M., Sampaio, P., Truong, H.Q.: Risks and supply chain performance: globalization and COVID-19 perspectives. *Int. J. Prod. Perform. Manag.* (2022). <https://doi.org/10.1108/IJPPM-03-2021-0179>
3. Ardito, L., Petruzzelli, A.M., Panniello, U., Garavelli, A.C.: Towards Industry 4.0: mapping digital technologies for supply chain management-marketing integration. *Bus. Process Manag. J.* **25**, 323–346 (2019). <https://doi.org/10.1108/BPMJ-04-2017-0088>
4. Stentoft, J., Aadsbøll Wickstrøm, K., Philipsen, K., Haug, A.: Drivers and barriers for Industry 4.0 readiness and practice: empirical evidence from small and medium-sized manufacturers. *Prod. Plann. Control* **32**, 811–828 (2021). <https://doi.org/10.1080/09537287.2020.1768318>
5. Castelo-Branco, I., Cruz-Jesus, B., Oliveira, T.: Assessing Industry 4.0 readiness in manufacturing: evidence for the European Union. *Comput. Ind.* **107**, 22–32 (2019). <https://doi.org/10.1016/J.COMPIND.2019.01.007>
6. Dautaj, M., Rossi, M.: Towards a new society: solving the dilemma between Society 5.0 and Industry 5.0. In: Junior, O.C., Noël, F., Rivest, L., Bouras, A. (eds.) *Product Lifecycle Management. Green and Blue Technologies to Support Smart and Sustainable Organizations. PLM 2021. IFIP Advances in Information and Communication Technology*, vol. 639, pp. 523–536. Springer, Cham (2022). [https://doi.org/10.1007/978-3-030-94335-6\\_37](https://doi.org/10.1007/978-3-030-94335-6_37)
7. Industry 5.0: European Commission. [https://ec.europa.eu/info/research-and-innovation/research-area/industrial-research-and-innovation/industry-50\\_en](https://ec.europa.eu/info/research-and-innovation/research-area/industrial-research-and-innovation/industry-50_en). Accessed 13 May 2022
8. Xu, X., Lu, Y., Vogel-Heuser, B., Wang, L.: Industry 4.0 and Industry 5.0— inception, conception and perception. *J. Manuf. Syst.* **61**, 530–535 (2021). <https://doi.org/10.1016/J.JMSY.2021.10.006>

9. Salimova, T., Vukovic, N., Guskova, N.: Towards sustainability through Industry 4.0 and Society 5.0. *Int. Rev.* 48–54 (2020). <https://doi.org/10.5937/INTREV2003048S>
10. Nahavandi, S.: Industry 5.0—a human-centric solution. *Sustainability* **11**, 4371 (2019). <https://doi.org/10.3390/SU11164371>
11. Akundi, A., Euressti, D., Luna, S., Ankobiah, W., Lopes, A., Edinbarough, I.: State of Industry 5.0—analysis and identification of current research trends. *Appl. Syst. Innov.* **5**, 27 (2022). <https://doi.org/10.3390/ASI5010027>
12. Lu, Y., et al.: Outlook on human-centric manufacturing towards Industry 5.0. *J. Manuf. Syst.* **62**, 612–627 (2022). <https://doi.org/10.1016/J.JMSY.2022.02.001>
13. Kaasinen, E., Anttila, A.H., Heikkilä, P., Laarni, J., Koskinen, H., Väättänen, A.: Smooth and resilient human–machine teamwork as an Industry 5.0 design challenge. *Sustainability* **14**, 2773 (2022). <https://doi.org/10.3390/SU14052773>
14. Longo, F., Padovano, A., Umbrello, S.: Value-oriented and ethical technology engineering in Industry 5.0: a human-centric perspective for the design of the factory of the future. *Appl. Sci.* **10**, 4182 (2020). <https://doi.org/10.3390/APP10124182>
15. Doyle-Kent, M., Kopacek, P.: Adoption of collaborative robotics in Industry 5.0. An Irish industry case study. *IFAC-PapersOnLine* **54**, 413–418 (2021). <https://doi.org/10.1016/J.IFACOL.2021.10.483>
16. Dimitropoulos, N., Togiias, T., Zacharaki, N., Michalos, G., Makris, S.: Seamless human–robot collaborative assembly using artificial intelligence and wearable devices. *Appl. Sci.* **11**, 5699 (2021). <https://doi.org/10.3390/APP11125699>
17. Dimitropoulos, N., Togiias, T., Michalos, G., Makris, S.: Operator support in human–robot collaborative environments using AI enhanced wearable devices. *Procedia CIRP* **97**, 464–469 (2021). <https://doi.org/10.1016/J.PROCIR.2020.07.006>
18. Javaid, M., Haleem, A., Singh, R.P., Ul-Haq, M.I., Raina, A., Suman, R.: Industry 5.0: potential applications in COVID-19. *J. Ind. Integr. Manag.* **5**, 507–530 (2020). <https://doi.org/10.1142/S2424862220500220>
19. Pillai, S.G., Haldorai, K., Seo, W.S., Kim, W.G.: COVID-19 and hospitality 5.0: redefining hospitality operations. *Int. J. Hospitality Manag.* **94**, 102869 (2021). <https://doi.org/10.1016/J.IJHM.2021.102869>
20. Javaid, M., Haleem, A.: Critical components of Industry 5.0 towards a successful adoption in the field of manufacturing. *S*, 327–348 (2020). <https://doi.org/10.1142/S2424862220500141>
21. Majernik, M., Daneshjo, N., Malega, P., Drábik, P., Barilová, B.: Sustainable development of the intelligent industry from Industry 4.0 to Industry 5.0. *Adv. Sci. Technol. Res. J.* **16**, 12–18 (2022). <https://doi.org/10.12913/22998624/146420>
22. Alvarez-Aros, E.L., Bernal-Torres, C.A.: Technological competitiveness and emerging technologies in industry 4.0 and industry 5.0. *Anais da Academia Brasileira de Ciências.* **93**, 20191290 (2021). <https://doi.org/10.1590/0001-3765202120191290>
23. Gürdür Broo, D., Kaynak, O., Sait, S.M.: Rethinking engineering education at the age of industry 5.0. *J. Ind. Inf. Integr.* **25**, 100311 (2022). <https://doi.org/10.1016/J.JII.2021.100311>
24. Matsuda, K., Uesugi, S., Naruse, K., Morita, M.: Technologies of production with Society 5.0. In: *BESC 2019 - 6th International Conference on Behavioral, Economic and Socio-Cultural Computing, Proceedings* (2019). <https://doi.org/10.1109/BESC48373.2019.8963541>
25. Özdemir, V., Hekim, N.: Birth of Industry 5.0: making sense of big data with artificial intelligence, “the Internet of Things” and next-generation technology policy. *OMICS* **22**, 65–76 (2018). <https://doi.org/10.1089/OMI.2017.0194>
26. Aslam, F., Aimin, W., Li, M., Rehman, K.U.: Innovation in the era of IoT and Industry 5.0: absolute innovation management (AIM) framework. *Information* **11**, 124 (2020). <https://doi.org/10.3390/INFO11020124>

27. Sharma, M., Sehrawat, R., Luthra, S., Daim, T., Bakry, D.: Moving towards Industry 5.0 in the pharmaceutical manufacturing sector: challenges and solutions for Germany. *IEEE Trans. Eng. Manag.* (2022). <https://doi.org/10.1109/TEM.2022.3143466>

**Open Access** This chapter is licensed under the terms of the Creative Commons Attribution 4.0 International License (<http://creativecommons.org/licenses/by/4.0/>), which permits use, sharing, adaptation, distribution and reproduction in any medium or format, as long as you give appropriate credit to the original author(s) and the source, provide a link to the Creative Commons license and indicate if changes were made.

The images or other third party material in this chapter are included in the chapter's Creative Commons license, unless indicated otherwise in a credit line to the material. If material is not included in the chapter's Creative Commons license and your intended use is not permitted by statutory regulation or exceeds the permitted use, you will need to obtain permission directly from the copyright holder.





# Establishment of an Appropriate Data Analytic Platform for Developing a Wisdom Manufacturing System Using Decision Techniques

Emanuel Fernando Zeferino<sup>1</sup>, Khumbulani Mpofu<sup>1</sup>, Olasumbo Makinde<sup>2</sup>(✉), and Boitumelo Ramatsetse<sup>1</sup>

<sup>1</sup> Tshwane University of Technology, Pretoria 0001, South Africa

<sup>2</sup> University of Johannesburg, Johannesburg 2028, South Africa

olasumbom@uj.ac.za

**Abstract.** In today's global business context, data has played a critical role in ensuring accurate and appropriate decision making in manufacturing organisations. Despite the huge pool of information (i.e. data) generated by consumers, repair or maintenance shops, manufacturing job shop, scientific society on various products, which could be deployed by manufacturers in eliciting vital information towards achieving sustainable product design and development, only few manufacturers are making use of this data to generate wisdom required for sustainable manufacturing. This act is caused by lack of appropriate systems capable of integrating the available data and make wise inferences that will result in a competitive advantage of a specific organisation over its competitors. In light of this, the aim of this study is to establish a suitable data analytic platform that could be used to sort, classify and integrate data required to generate wisdom vital for sustainable manufacturing. In order to achieve this, Analytical Hierarchy Process (AHP) was deployed to appraise various alternative data analytical platforms such as Python, Apache Spark, Qlik View, Power BI, Tableau, KNIME, Excel, Talend, Rapid Miner and Statistical Analysis System (SAS) using various criteria such as Data Format, Availability, Interface, Programming Intensity, Data Science Knowledge Intensity and Capabilities. The result of this decision analysis and selection exercise, revealed that KNIME data analytic platform, with the most important decision criterion; data science knowledge intensity, and a cumulative assessment score of 80.80 is the appropriate data analytic platform that manufacturers should use to generate a knowledge advisor vital for sustainable manufacturing and product development.

**Keywords:** Wisdom Manufacturing · Data Analytics · Analytical Hierarchy Process · Decision Analysis

## 1 Introduction

Manufacturing systems have gone through abrupt changes given the dynamic nature of the environment in which they operate. Customer and system user demands, technological advancements, environmental demands, competition, globalisation and the ability



to de-globalise are some of the factors driving this fast change (Gola and Świć 2012). Yao et al. (2019), stated that personalisation and innovation are today's major metrics to evaluate manufacturing systems and has become the key transformation driver of the 21st century. The ability to have the voice of all stakeholders throughout the process of innovation, product development and manufacturing is one key competitive advantage an organisation can have in today's business environment. Currently existing manufacturing systems have limitations in fully meeting this demand through optimal integration of all stakeholder voices in their service or product offering (Yao et al. 2015). Abramovici (2007) stated that only one out of seven products ideas succeed in the market. This high failure is caused mainly due to lack of customer orientation.

With the social media platforms, there is a room to obtain nearly real-time sentiments from the people within the communities (i.e. the customers) on the products they use. Furthermore, with the advent of Industry 4.0 (Xiong et al. 2017), there is opportunity to deploy embedded sensors to source real-time information on the product health status as well deploy the use of designed database system to elicit information about the product repair records which constitute another stream of product data. Therefore, opportunity exist to integrate these various stream of data, and conduct adequate data analytics on them, towards unveiling wise design idea decisions that would ensure sustainable product design and development.

Wisdom manufacturing can be achieved via the use of Cyber Physical Social System (Yin et al. 2020). According to (Zeng et al. 2016), Cyber Physical Social System (CPSS) are complex systems that satisfy the limitations of the Cyber Physical Systems (CPS) and Cyber Social System (CSS) in order to meet people's social interactions demands and react to the physical world. CPSSs have been deployed for various applications such as military command and control operations (Liu et al. 2011), smart transport systems (Xiong et al. 2015), smart home (Smirnov et al. 2015), smart medical services (Sheth et al. 2013) and smart cities (Costanzo et al. 2016).

The realisation of WM is the state-of-art manufacturing system that has both the ability to incorporate the social interaction in the process of manufacturing and the product life cycle as well as physical data collected from the product and/or the immediate and broader production environment. Hence, mining relevant data from operators' social interactions, millions of consumer social media posts, product, equipment and experts publications is a cumbersome task that can only be accomplished through the use of suitable and well-designed algorithms (Abrahams et al. 2012). Social data such as customers, experts, enterprises and other stakeholder's interaction in the various social media platform, can be collected using social sensors (Ding and Jiang 2016). Physical data such as the health status of a product (Bogue 2014), human-related information (Taraldsen et al. 2012) as well as surrounding environment status such as weather condition (Hernández-del-Olmo et al. 2019) can be gathered by use of physical sensors.

Natural text analytics extracted from the data collected from various streams of data is pivotal for the implementation of the CPSS concept. Abrahams et al. (2013), discussed text mining tools for categorizing and obtaining product intelligence from user-generated contents in social media. Various data analytic platforms such as Microsoft Excel (Neyeloff et al. 2012), R and Python (Louridas and Ebert 2013), Tableau and Power BI (Negrut 2014) and Konstanz Information Miner (KNIME) platform (Minanovic et al.

2014) have been deployed in the literature for natural text analytics. However, selection of an appropriate data analytic platform based on the strength and weaknesses of these platforms towards ensuring accurate and sound natural text analytics is a salient issue that need to be discussed. In light of this, this study intend to investigate and ascertain a suitable data analytic platform that could be used to integrate various streams of data towards extracting suitable decisions that will promote wisdom manufacturing in various organisations. The structure of the paper are as follows. The second section present the methodology used in this study. The third section present and discuss the results obtained from this study while the last section draw conclusion based on the results obtained from the study and thereafter unveil the future research work.

## 2 Methodology

Two decision techniques, namely, the Analytical Hierarchy Process (AHP) and the Weighted Decision Matrix (WDM) were used to ascertain the suitable data analytic platform that could be used to develop a wisdom manufacturing system. The ten (10) data analytic platform alternatives considered in this study for developing wisdom manufacturing system are Apache Spark (DAP I), KNIME (DAP J), Power BI (DAP K), Python (DAP L), Qlik View (DAP M), Tableau (DAP N), Microsoft Excel (DAP O), Talend (DAP P), Rapid Miner (DAP Q), and Statistical Analysis System (DAP R). The various criteria used to evaluate the capability of the aforementioned data analytic platforms for developing wisdom manufacturing are discussed as follows:

- 1) Data Science Knowledge Intensity (DSKI): This criterion served to classify the data science knowledge required for the user to work with the tool. The classification ranged from low to high. Given that current tools are being developed so that it is simpler for an average data scientist to use, the lower the expertise knowledge required to use a machine learning tool, the more the tool is desirable by users.
- 2) Programming Intensity (PI): This criterion was used to classify the level of programming skills required to use the software. The classification followed a similar approach as that of DSKI level described above. The less programming expertise required, the more desirable is the tool.
- 3) Interface (I): This criterion describes the type of interface used in operating the tool. The desired tool should have a much user friendly interface, so that it is easy to use.
- 4) Capabilities (C): this criterion describes major functions provided by the tool concerning data analysis, visualization and machine learning as well as capabilities to integrate with other platforms. The more the capabilities offered by the specific tool, the more desirable the tool is for the study.
- 5) Data Format (DF): this criterion describes the data types which are supported by the tool to conduct the analysis or machine learning operation. Given that there is a need to conduct the analysis on csv, excel, pdf and data in any other format, the more formats the tool can accommodate the better for the user of the tool.
- 6) Availability (A): not all analytic tools are easily available; they range from free of charge to high cost licences. Some of the tools have limited versions available for free and the capabilities increase based on the licence acquired. For the purpose

of this study, despite all the above criteria, cost of the tool acquisition was highly considered. Freely accessible versions were highly desirable if not compromising the required capabilities needed to conduct the big data analytic exercise.

In the context of this study, the Analytical Hierarchy Process (AHP) was deployed to ascertain the priority weight score of each criterion considered in this study while the WDM was used to ascertain the performance of each alternative data analytic platform considered in this study using the priority weight score of each criterion considered in this study and the rating score of each alternative data analytic platform under each criterion. The procedures used to carry out the AHP and WDM decision analysis are highlighted in the subsequent sections.

## 2.1 Analytical Hierarchy Process

The pairwise comparison of each criterion against one another was conducted by the authors using the fundamental scale of pairwise comparison and random consistency analysis formulated by Saaty (2008). After this criteria comparative analysis, the most important criterion to satisfy the design requirements of the suitable data analytic platform for wisdom manufacturing system is the criterion with the highest priority weight score while the criterion with the lowest priority weight score is the least important criterion.

## 2.2 Weighted Decision Matrix

The rating score for each data analytic platform that could be used for wisdom manufacturing system was rated using a three level scale. The three level scale for criterion; *DF* are tagged as *less than or equal to 5*, *6 to 10* and *11 or more*. The three level scale for criteria; *A* and *I* are tagged as *Easy*, *Moderate* and *Difficult/Complex* while the three level scales for criteria; *PE*, *DSE* and *C* are tagged as *Low*, *Moderate* and *High*. The level scales for criteria; *DF* and *C* are awarded a grade score of *10*, *50* and *100* respectively. The level scales for criteria; *A*, *I*, *PE* and *DSE* are awarded a grade score within a range of *100*, *50*, and *10* respectively. If  $PW_a, PW_b, PW_c, PW_d, PW_e$  and  $PW_f$  represent the priority weight score of each criterion obtained from the AHP analysis, and  $R_a, R_b, R_c, R_d, R_e$  and  $R_f$  represent the grade score for each of the criterion used to appraise each data analytic platform, then the cumulative performance grade score for each data analytic platform that could be used for a wisdom manufacturing system is calculated using Eq. (1).

$$PGS_n = \sum_{i=a}^f (PW_i \times R_i) \quad (1)$$

where  $PGS_n$  represent the performance grade score for each alternative data analytic platform  $n$  considered in this study, and  $n = 1, 2, 3, 4, 5, 6, 7, 8, 9, 10$ .

Therefore, the data analytic platform with highest cumulative performance grade score is the suitable data analytic platform that could be used for a wisdom manufacturing system.

### 3 Results and Discussion

#### 3.1 Results of Analytical Hierarchy Process Assessment

The pairwise comparison matrix (*C*) of the assessed criteria is presented in Eq. 2.

$$C = \begin{pmatrix} \text{Criteria} & DF & A & I & PI & DSKI & C \\ DF & 1 & 4 & 3 & 3 & 1/2 & 3 \\ A & 1/4 & 1 & 3 & 3 & 1/4 & 1/3 \\ I & 1/3 & 1/3 & 1 & 2 & 1/4 & 1/3 \\ PI & 1/3 & 1/3 & 1/2 & 1 & 1/4 & 1/3 \\ DSKI & 2 & 4 & 4 & 4 & 1 & 2 \\ C & 1/3 & 3 & 3 & 3 & 1/2 & 1 \end{pmatrix} \tag{2}$$

The normalised comparison matrix, *N*, obtained by dividing each element in each column of Eq. 2 by each column summation value is depicted in Eq. 3.

$$N = \begin{pmatrix} \text{Criteria} & DF & A & I & PE & DSKI & C \\ DF & 0.235 & 0.316 & 0.207 & 0.188 & 0.182 & 0.429 \\ A & 0.059 & 0.079 & 0.207 & 0.188 & 0.091 & 0.048 \\ I & 0.078 & 0.026 & 0.069 & 0.125 & 0.091 & 0.048 \\ PI & 0.078 & 0.026 & 0.034 & 0.063 & 0.091 & 0.048 \\ DSKI & 0.471 & 0.276 & 0.250 & 0.354 & 0.364 & 0.286 \\ C & 0.078 & 0.237 & 0.207 & 0.188 & 0.182 & 0.143 \end{pmatrix} \tag{3}$$

After obtaining the normalized values, the criteria weight (*CW*) was calculated by obtaining the average value of each row of equation to represent the weight of the respective row criteria. The resultant matrix of the computation is presented in Eq. 4.

$$CW = \begin{pmatrix} 0.259 \\ 0.112 \\ 0.073 \\ 0.057 \\ 0.327 \\ 0.172 \end{pmatrix} \tag{4}$$

Based on the criteria weight matrix presented in Eq. (4), it could be inferred that the weight scores for each criterion are 0.259, 0.112, 0.073, 0.057, 0.327 and 0.172 respectively. In light of this, the criterion; “data science knowledge intensity” is the most important criterion, since it has the highest pairwise criterion weight score.

The result of the Consistency Ratio (CR) computed to confirm the authenticity of the pairwise criterion assessment exercise done in this study was valued at 0.076. Since this result is less than 0.1 as asserted in study of Saaty (2008), therefore, it can be concluded that the pairwise comparison analysis carried out were consistent and not biased.

#### 3.2 Results of Weighted Decision Matrix Assessment

The result of the WDM assessment tailored towards ascertaining a suitable data analytic platform for wisdom manufacturing system using the priority weight scores of the decision criteria obtained from the AHP analysis is depicted in Tables 1 and 2.

**Table 1.** WDM Results of the Data Analytic Platform Alternatives Evaluation

Criteria	$W_i$	DAP I		DAP J		DAP K		DAP L		DAP M	
		Ratings	$WS_j$	Ratings	$WS_j$	Ratings	$WS_k$	Ratings	$WS_l$	Ratings	$WS_m$
DF (a)	25.9 %	50	12.95	100	25.90	50	12.95	100	25.90	100	25.90
A (b)	11.2%	50	5.60	100	11.20	10	1.12	100	11.20	50	5.60
I (c)	7.3%	100	7.30	100	7.30	100	7.30	10	0.73	100	7.30
PE (d)	5.7%	50	2.85	50	2.85	50	2.85	10	0.57	50	2.85
DSE (e)	32.7%	50	16.35	50	16.35	50	16.35	10	3.27	50	16.35
C (f)	17.2%	50	8.60	100	17.20	50	8.60	100	17.20	50	8.60
<b>Total</b>			<b>53.65</b>		<b>80.80</b>		<b>49.17</b>		<b>58.87</b>		<b>66.60</b>
<b>Rank</b>			4		1		6		3		2

**Table 2.** Continuation of the WDM Results of the Data Analytic Platform Alternatives Evaluation

Criteria	$W_i$	DAP N		DAP O		DAP P		DAP Q		DAP R	
		Ratings	$WS_N$	Ratings	$WS_O$	Ratings	$WS_P$	Ratings	$WS_Q$	Ratings	$WS_R$
DF (a)	25.9%	50	12.95	10	2.59	50	12.95	50	12.95	50	12.95
A (b)	11.2%	50	5.60	100	11.20	50	5.60	50	5.60	10	1.12
I (c)	7.3%	50	3.85	50	3.65	100	7.30	100	7.30	50	3.65
PE (d)	5.7%	50	2.85	50	2.85	50	2.85	50	2.85	50	3.42
DSE (e)	32.7%	50	16.35	50	16.35	50	16.35	50	16.35	50	16.35
C (f)	17.2%	50	8.60	50	8.60	50	8.60	50	8.60	50	8.60
<b>Total</b>			<b>50.02</b>		<b>45.24</b>		<b>53.65</b>		<b>53.65</b>		<b>46.09</b>
<b>Rank</b>			5		8		4		4		7

Based on Tables 1 and 2, it could be deduced that the cumulative assessment scores of the data analytic platform alternatives I, J, K, L, M, N, O, P, Q and R are 53.65, 80.80, 49.17, 58.87, 66.60, 50.02, 45.24, 53.65, 53.65 and 46.09 respectively. In light of this, Data Analytic Platform J (i.e. KNIME) is the most suitable data analytic platform for WMS since it has the highest cumulative assessment score. This platform combines an easy to use flow interface and different scripting capabilities for personalised algorithms; it supports a variety of files formats and is able to perform all required operations in the WMS framework with minimum programming requirements. Furthermore, it is an open source platform.

## 4 Conclusion

Wisdom Manufacturing is a futuristic user-centred and data driven manufacturing paradigm which encompasses the inclusion of all product stakeholders throughout the product lifecycle to derive wisdom for product manufacturing and improvement. In light of this, ten (10) data analytic platform alternatives that could be used to achieve Wisdom Manufacturing were evaluated using AHP and WDM decision techniques, in order to ascertain the suitable platform. The criterion, DSE with a priority weight of 32.7%, amidst other criteria such as DF, A, I, PE and C, was considered the most important criterion that should be considered for selecting a suitable data analytic platform for WM. The data analytic platform alternatives performance assessment using the aforementioned criteria unveiled that KNIME is the suitable data analytic platform that should be used in manufacturing organisations to achieve WM. This article provide a decision assessment framework for production managers in manufacturing organisations to make the right decision when selecting data analytic platform to achieve WM. Simulation of the WMS framework using the KNIME data analytic platform should be explored in future studies.

## References

- Abrahams, A.S., Jiao, J., Fan, W., Wang, G.A., Zhang, Z.: What's buzzing in the blizzard of buzz? Automotive component isolation in social media postings. *Decis. Support Syst.* **55**(4), 71–882 (2013)
- Abrahams, A.S., Jiao, J., Wang, G.A., Fan, W.: Vehicle defect discovery from social media. *Decis. Support Syst.* **54**(1), 87–97 (2012)
- Abramovici, M.: Future trends in product lifecycle management (PLM). In: Krause, F.L. (ed.) *The Future of Product Development*, pp. 665–674. Springer, Heidelberg (2007). [https://doi.org/10.1007/978-3-540-69820-3\\_64](https://doi.org/10.1007/978-3-540-69820-3_64)
- Bogue, R.: Towards the trillion sensors market. *Sens. Rev.* **34**(2), 137–142 (2014)
- Costanzo, A., Faro, A., Giordano, D., Spampinato, C.: Implementing cyber physical social systems for smart cities: a semantic web perspective. In: 2016 13th IEEE Annual Consumer Communications & Networking Conference (CCNC), pp. 274–275. IEEE (2016)
- Ding, K., Jiang, P.: Incorporating social sensors and CPS nodes for personalized production under social manufacturing environment. *Procedia CIRP* **56**, 366–371 (2016)
- Gola, A., Świć, A.: Directions of manufacturing systems: evolution from the flexibility level point of view. In: *Innovations in Management and Production Engineering*, Oficyna Wyd. Polskiego Towarzystwa Zarządzania Produkcją, Opole, pp. 226–238 (2012)
- Hernández-del-Olmo, F., Gaudioso, E., Duro, N., Dormido, R.: Machine learning weather soft-sensor for advanced control of wastewater treatment plants. *Sensors* **19**(14), 31–39 (2019)
- Liu, Z., Yang, D.S., Wen, D., Zhang, W.M., Mao, W.: Cyber-physical-social systems for command and control. *IEEE Intell. Syst.* **26**(4), 92–96 (2011)
- Louridas, P., Ebert, C.: Embedded analytics and statistics for big data. *IEEE Softw.* **30**(6), 33–39 (2013)
- Minanovic, A., Gabelica, H., Krstić, Ž.: Big data and sentiment analysis using KNIME: online reviews vs. social media. In: 2014 37th International Convention on Information and Communication Technology, Electronics and Microelectronics (MIPRO), pp. 1464–1468. IEEE (2014)
- Negrut, V.: Power BI: effective data aggregation. *Quaestus Multidisc. Res. J.* **13**, 146–153 (2014)

- Neyeloff, J.L., Fuchs, S.C., Moreira, L.B.: Meta-analyses and Forest plots using a microsoft excel spreadsheet: step-by-step guide focusing on descriptive data analysis. *BMC. Res. Notes* **5**(1), 1–6 (2012). <https://doi.org/10.1186/1756-0500-5-52>
- Saaty, T.L.: Decision making with the analytic hierarchy process. *Int. J. Serv. Sci.* **1**(1), 83–98 (2008)
- Sheth, A., Anantharam, P., Henson, C.: Physical-cyber-social computing: an early 21st century approach. *IEEE Intell. Syst.* **28**(1), 78–82 (2013)
- Smirnov, A., Kashevnik, A., Ponomarev, A.: Multi-level self-organization in cyber-physical-social systems: smart home cleaning scenario. *Procedia CIRP* **30**, 329–334 (2015)
- Taraldsen, K., Chastin, S.F., Riphagen, I.I., Vereijken, B., Helbostad, J.L.: Physical activity monitoring by use of accelerometer-based body-worn sensors in older adults: a systematic literature review of current knowledge and applications. *Maturitas* **71**(1), 13–19 (2012)
- Xiong, G., et al.: From mind to products: towards social manufacturing and service. *IEEE/CAA J. Autom. Sin.* **5**(1), 47–57 (2017)
- Xiong, G., et al.: Cyber-physical-social system in intelligent transportation. *IEEE/CAA J. Autom. Sin.* **2**(3), 320–333 (2015)
- Yao, X., Jin, H., Zhang, J.: Towards a wisdom manufacturing vision. *Int. J. Comput. Integr. Manuf.* **28**(12), 1291–1312 (2015)
- Yao, X., Zhou, J., Lin, Y., Li, Y., Yu, H., Liu, Y.: Smart manufacturing based on cyber-physical systems and beyond. *J. Intell. Manuf.* **30**(8), 2805–2817 (2019). <https://doi.org/10.1007/s10845-017-1384-5>
- Yin, D., Ming, X., Zhang, X.: Understanding data-driven cyber-physical-social system (D-CPSS) using a 7C framework in social manufacturing context. *Sensors* **20**(18), 5319–5331 (2020)
- Zeng, J., Yang, L.T., Ma, J.: A system-level modeling and design for cyber-physical-social systems. *ACM Trans. Embed. Comput. Syst. (TECS)* **15**(2), 1–26 (2016)

**Open Access** This chapter is licensed under the terms of the Creative Commons Attribution 4.0 International License (<http://creativecommons.org/licenses/by/4.0/>), which permits use, sharing, adaptation, distribution and reproduction in any medium or format, as long as you give appropriate credit to the original author(s) and the source, provide a link to the Creative Commons license and indicate if changes were made.

The images or other third party material in this chapter are included in the chapter's Creative Commons license, unless indicated otherwise in a credit line to the material. If material is not included in the chapter's Creative Commons license and your intended use is not permitted by statutory regulation or exceeds the permitted use, you will need to obtain permission directly from the copyright holder.





# Implementation Framework for Blockchain-Based Traceability to Tackle Drug-Counterfeiting: Embracing Sustainable Pharma Logistics Networks

Benjamin Nitsche<sup>(✉)</sup>, Frank Straube, Tom-Li Kämper, and Simon Zarnitz

Technische Universität Berlin, Straße des 17. Juni 135, 10623 Berlin, Germany  
nitsche@logistik.tu-berlin.de

**Abstract.** Fighting counterfeit drugs in pharma logistics networks, is one of the most important challenges in the industry. In order to contribute to the UN Sustainable Development Goal of “global health and well-being” the integration of counterfeit substances and drugs has to be stopped but is still causing significant human and economic damage. Although the problem is known for decades no approach is known that eradicates the problem. Blockchain technology is promoted as a potential solution to counterfeit drugs since it combines the properties of tamper-proof data storage and secure information transfer but its’ application in the pharma industry is still lacking behind the theoretical potential. This study seeks to assess the applicability of blockchain technology to tackle drug counterfeiting in pharma networks and to develop an implementation framework that outlines industry-specific implementation barriers and mitigation measures as well as their interdependencies. Building on nine interviews with industry experts, Grounded Theory was applied. Accordingly, the interview results were condensed into a theory by applying a three-stage coding process. Building on this analysis, an implementation framework for blockchain technology to tackle drug counterfeiting in the pharma industry is developed. The framework explains the enablers, barriers, and implementation strategies as well as the relation between them. It is shown that blockchain implementation is not hindered by a lack of technological maturity, but mostly by opposing incentive mechanisms of stakeholders involved.

**Keywords:** Pharmaceutical supply chain · distributed ledger networks · blockchain · drug counterfeit · transparency

## 1 Introduction

Trust in the integrity of pharmaceutical products is one of the cornerstones of sustainable international pharma networks [1]. This trust is increasingly threatened by counterfeit medicine, which causes significant economic and human damage worldwide making it very difficult to achieve the UN Sustainable Development Goal 3 (“Ensure healthy lives and promote well-being for all at all ages”) [2]. The main reason for the occurrence of non-legitimate medicine is the complexity of heavily fragmented pharma networks.

© The Author(s) 2023

H. Kohl et al. (Eds.): GCSM 2022, LNME, pp. 630–637, 2023.

[https://doi.org/10.1007/978-3-031-28839-5\\_71](https://doi.org/10.1007/978-3-031-28839-5_71)



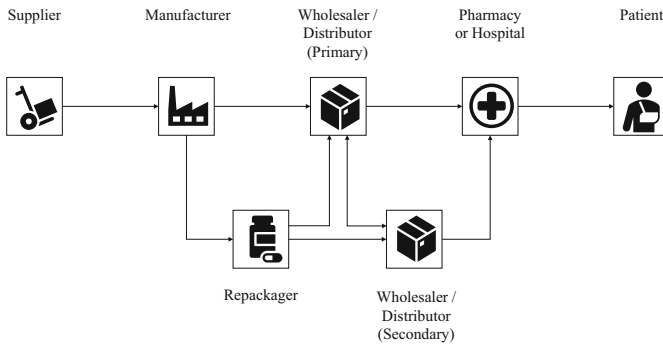
Throughout all value-adding processes, numerous transfer points between various actors in the logistics network exist with different informational interfaces leading to highly fragmented and inconsistent data flows [3]. This reduces transparency and trust and significantly complicates authenticity checks throughout the logistics network [4, 5]. Although this problem is known for decades, the need for a technology that addresses compatibility and credibility issues while allowing the alignment with legal requirements is still imminent.

Since blockchain combines the properties of tamper-proof data storage and secure information transfer, its deployment as a traceability solution in logistics networks is discussed in several fields [6]. Also, in the pharma industry several ideas emerge that promise a high potential for the industry. However, there is a variety of conditions that should be met to ensure that the technological benefits outweigh the technological shortcomings [7]. In general, blockchain allows meeting all legal requirements that are mandatory for pharmaceutical traceability solutions [8]. As a result, the technology seems to be the ideal foundation for automating transactions and increase operational efficiency [9]. Despite all those theoretical benefits, adoption in pharma logistics networks is slow and only few blockchain solutions in the pharma logistics network exceed a prototypical implementation [9]. The vast amount of blockchain research focuses on the identification and analysis of blockchain use cases, but research regarding the transfer from science to practice is scarce. In this regard, most blockchain literature is not industry-specific and therefore doesn't apply the proprietary mechanics and limitations of the pharmaceutical industry to their respective models. Furthermore, the specific challenges of the pharma logistics network and respective mitigation strategies remain unclear [10]. To contribute to this under-investigated area and to support future managers in the pharma industry, this study seeks to develop an implementation framework that outlines industry-specific implementation barriers, mitigation measures and enablers of blockchain implementations to tackle drug counterfeiting in pharma logistics networks. More specifically we aim at investigating the following research question: *What are the most relevant enablers and barriers as well as implementation strategies for adopting blockchain in the pharma logistics network and how do they interconnect and interdepend?*

To contribute to the RQs, the study analyses nine interviews with experts from the industry applying Grounded Theory (GT) methodology.

## **2 Theoretical Background: The Pharma Logistics Network and the Problem of Counterfeit Drugs**

The term counterfeit medicines commonly refers to drugs in which ingredients are either not contained at all, not in the specified concentration, or in which components have been replaced by harmful substances [8]. Criminals usually focus on counterfeiting the most lucrative medications, which often have the most severe health effects on patients. These include painkillers, antibiotics, contraceptives as well as medicines for cancer and cardiovascular diseases [11]. The pharma logistics network is highly complex and is composed of several actors. A simplified version of those actors involved is shown in Fig. 1.



**Fig. 1.** Pharmaceutical logistics networks

Contrary to this simplified illustration, the pharmaceutical industry comprises many multinational stakeholders involved in the processes. Concerning the in-sourcing of counterfeit medicines, several points in the logistics network are vulnerable to corruption. There is the risk that suppliers do not deliver the right ingredients. Those can be outdated, altered, or not contained in the right concentration [4]. Also, a completely different raw material may be supplied, which will not only fail to induce the desired pharmaceutical effect but may even cause harm to the patient [12]. The majority of counterfeit medicines enter the logistics network at the manufacturer's level. The wrong ingredients may be used or the right ingredients in the wrong concentration. Also, there is a risk during the packaging processes, as a counterfeit might be packaged with legitimate cartonnage, making it almost indistinguishable from authentic medicine [12].

Also, risks occur at the interface between manufacturers and wholesalers/distributors. While primary wholesalers indeed source their products from manufacturers, this is not necessarily the case with secondary wholesalers. In reality, a company's position as a secondary or primary wholesaler is not immediately apparent. For example, a wholesaler may purchase a type of drug from one manufacturer and at the same time from a secondary wholesaler if market demand exceeds the manufacturer's production capacity. This transfer of drugs between different distributors is not uncommon in the pharmaceutical industry. Often, products are repackaged at each handling before being forwarded to the next company. This recursive and non-transparent transport of goods creates a very high degree of opacity regarding the provenance of medications [5].

At the wholesale level, counterfeit drugs may be mixed with legitimate products. This process is called *sating* and can happen without the malicious intent of a wholesaler. *Sating* occurs, for example, when a primary wholesaler purchases drugs from a secondary wholesaler who has unwittingly purchased counterfeit drugs. Subsequently, counterfeit drugs may receive authenticity labels during repackaging at the primary wholesaler and are identified as legitimate in subsequent tracking processes. Repackaging at the wholesaler's level poses additional risks. Since manufacturers often sell their drugs in fraud-protected packaging, repackaging may remove authenticity features [5]. Finally, illegal drugs are often insourced at the pharmacy level. In particular online pharmacies represent a compelling opportunity to acquire medicines at low cost. At the same time, they are one of the most significant sources of counterfeit medicine in-sourcing [1].

### 3 Methodology

GT was chosen as a suitable methodology as it allows to understand the process behind a research object and to explore creative perspectives and insights regarding human interactions and business practices. In this regard, GT facilitates the development of theoretical models grounded in empirical data and their systematic analysis. Particularly in the research discipline of logistics and supply chain management, and even more so in the identification of critical success factors, GT has been widely accepted as a valid research methodology. Knowledge about blockchain and pharma logistics networks was gained and used during data collection, data analysis and theory generation. Within the GT methodology, both qualitative and quantitative data sources can be used to build theory. Data can be collected through focus groups, questionnaires, surveys, transcripts, letters, government reports, documents, grey literature, music, artifacts, videos, blogs and memos [13]. Especially interviews are a well-recognized method for data collection [14].

**Table 1.** Overview of interview partners

ID-No.	Industry Function	Job description	YoE
M1	Drug manufacturer	Senior VP Strategic Projects	39
M2	Drug manufacturer	Head of Regional SCM EMEA	15
W1	Wholesale association	Deputy Director General & Legal Advisor	17
W2	Wholesaler	Head of Corporate Infrastructure	9
P1	Hospital Pharmacy	SAP-EDV Coordinator	16
RC1	Blockchain research consortium/Manufacturer	Finished Goods Traceability Expert/IT Digital Lead Product Supply SCM	20
RC2	Blockchain research consortium/Manufacturer	Finished Goods Traceability Expert/Global Project Manager Supply Chain	20
RC3	Blockchain research consortium/Manufacturer	Industry Project Leader/Head of Supply Chain IT	24
RC4	Blockchain solution provider	CEO	15

In total 9 interviews were successfully conducted with an average of 50 min of interview length. In total, 413 min of interview recordings were analyzed. This resulted in the transcription of 64,513 words, which led to an overall transcript of 137 pages in length. In Table 1, the 9 experts are described in more detail in terms of their industry function, job position and years of experience (YoE) in the industry.

Based on the transcripts of the interviews, a data structure consisting of first-order concepts, second-order categories and higher-level aggregate dimensions was derived. A complete overview of the structure can be given upon request. In detail, the open-coding process examined 512 quotations from the transcripts of the interviews. These

quotations were condensed into 251 initial concepts based on overlaps in meaning. Then, the 251 open-coding concepts were abstracted to 69 second-order categories during axial coding. To improve the accessibility of results, the 69 second-order categories were aggregated into 36 second-order category clusters which present an aggregated form of the second-order categories. Despite this being a deviation from the usual data structure of grounded theory models, this approach allowed for better understandability of the models without sacrificing explanatory value. A final increase in abstraction was achieved by identifying 10 aggregated dimensions from which all second-order categories and first-order concepts can be derived. The coding results were then assigned to key areas of enablers, barriers and implementation strategies.

## 4 Results

Figure 2 summarizes the findings of the grounded theory model. The left side comprises the identified implementation enablers, which positively affect the implementation strategies via the dashed lines. The right side visualizes the implementation barriers, whose constraining effects on the implementation strategies are represented by dotted arrows. In the middle of the model, the three aggregate strategy dimensions are displayed along with their second-order category clusters. The solid arrows illustrate the causal relationships between the individual elements. As for many GT models, a complex understanding of the mechanisms in the respective research field emerges. For this model, this leads to the fact that all the information gained about the process can hardly be presented in the context of a brief conference paper. Therefore, the core findings are presented here instead of discussing all dimensions in detail. However, upon request, all information can be provided in more detail.

Looking into the barriers it can be seen that the pharma industry is very slow in adopting new technologies which is also because the industry is very reactive to legislative requirements. At the European level, the DataMatrix-code increased the security against counterfeit medicines to such an extent that illegal drugs hardly matter any-more and the incentive to purchase illegal medicines diminished substantially over recent years. Moreover, initiating a blockchain solution would require several technological standards that are hard to introduce in a very fragmented pharma industry with many stakeholders having different target systems and fearing competitive disadvantage. The non-willingness to share certain information can also be observed in the pharma industry since information asymmetries are often beneficial for some parties in the chain. Wholesalers risk negative consequences from full information transparency. On the one hand, wholesalers are concerned that manufacturers could exploit data transparency to control the flow of products through the logistics network, reducing the wholesalers' scope for action. On the other hand, wholesalers source their products from different countries to leverage price advantages, thereby decreasing product costs and easing the burden on the healthcare system. Even though this form of parallel importation is legal and allows patients to purchase safe and high-quality pharmaceuticals at attractive prices, tracking efforts are enormous. Parallel imports pass through complex logistics networks and cross multiple jurisdictions before being dispensed.

There are several strategies to cope with a plethora of barriers. However, stakeholders' incentivization and collaboration emerged as the central strategy that opposes a

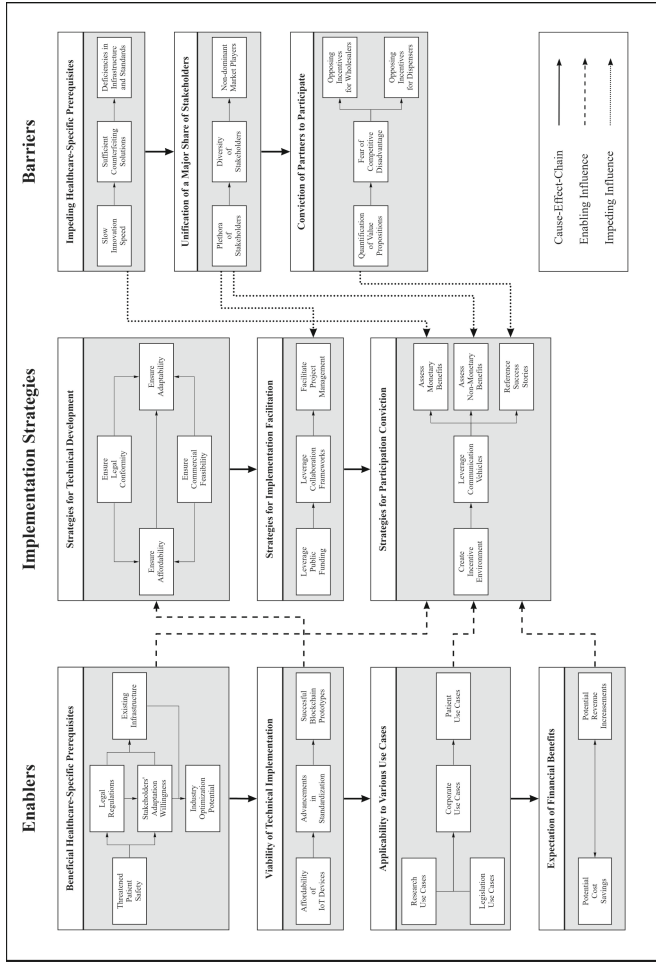


Fig. 2. Implementation framework for blockchain-based traceability to tackle drug-counterfeiting

huge challenge for successful blockchain implementation. Accordingly, most blockchain implementation projects do not fail due to the technology’s immaturity but because of the unwillingness of the required partners. Hence, a holistic approach that provides smooth implementation processes in a resource-saving manner is needed. On the one hand, an incentive environment for using the technology has to be created. On the other hand, blockchain developers should regard streamlined adaptation processes and cost-efficient operation from the beginning. Since most pharmaceutical enterprises act largely independent and profit-oriented, heavy investments need to be justified by beneficial returns of investment. Patient safety, however, is difficult to quantify and therefore hard to measure as a KPI. Thus, the assessment of monetary value propositions becomes more important. Especially in the EU, where supply chains are very secure, improving anti-counterfeiting doesn’t suffice as a sole motivator for large implementation projects. This insight might

be the biggest contradiction to researchers' opinions, who suggest anti-counterfeiting as the primary use case for global blockchain implementation. The justification of financial expenditures is even more challenging for those stakeholders that have to invest the most but benefit the least from new solutions. In the pharma logistics network, this applies in particular to wholesalers. They already contain high visibility over the information flows with the existing end-to-end solution. Moreover, wholesalers need to introduce individual mass scanning for all products to allow full data transparency in the EU. This, however, is heavily disincentivized due to competitive pressure and low-profit margins. Consequently, the likelihood of success for the deployment of blockchain is relatively independent on technological advancements. Instead, incentive mechanisms are needed to justify the adaptation for each stakeholder individually.

## 5 Limitations and Final Remarks

Although this study provides interesting insights that expand the current state of science, its limitations must also be mentioned. The number of interviews conducted is still low considering the variety of stakeholders in the process. However, most important stakeholders have been covered and all interview participants had expertise about issues along the entire logistics network, leading to a low probability of bias in the data. Furthermore, interviewees came from the field of logistics and supply chain and comprised high blockchain expertise, but with limited experience in concrete technological configuration and implementation as software developers. Still, it is very unlikely that the main insights of this thesis become invalid.

This study addresses the research gap of analyzing blockchain implementation given a specific use case. As a result, the pharma industry's dynamics and strategies were systematized and related. However, the derived implementation framework does not provide an action guide to select interrelated work packages for project management purposes. Instead, future research is needed in applying and developing the created framework within the pharma industry. This will require intensified networking between developers and management as well as the analyses of industry-specific incentive systems. Furthermore, in-depth assessments of stakeholders' requirements need to be executed to support developers in designing a fitting, compliant and streamlined blockchain platform. With these efforts being made, blockchain may grow beyond technical feasibility studies and find its way into the commercial use of various industries.

## References

1. Clohessy, T., Clohessy, S.: What's in the box? Combating counterfeit medications in pharmaceutical supply chains with blockchain vigilant information systems. In: Treiblmaier, H., Clohessy, T. (eds.) *Blockchain and Distributed Ledger Technology Use Cases*. PI, pp. 51–68. Springer, Cham (2020). ISBN: 978-3-030-44336-8 [https://doi.org/10.1007/978-3-030-44337-5\\_3](https://doi.org/10.1007/978-3-030-44337-5_3)
2. United Nations Work of the Statistical Commission Pertaining to the 2030 Agenda for Sustainable Development, United Nations, General Assembly, New York, p. 25 (2017)

3. Hastig, G.M., Sodhi, M.S.: Blockchain for supply chain traceability: business requirements and critical success factors. *Prod. Oper. Manag.* **29**, 935–954 (2020). <https://doi.org/10.1111/poms.13147>
4. Clark, B., Burstall, R.: Blockchain, IP and the pharma industry—how distributed ledger technologies can help secure the pharma supply chain. *J. Intellect. Property Law Pract.* **13**, 531–533 (2018). <https://doi.org/10.1093/jiplp/jpy069>
5. Saxena, N., Thomas, I., Gope, P., Burnap, P., Kumar, N.: PharmaCrypt: blockchain for critical pharmaceutical industry to counterfeit drugs. *Computers* **53**, 29–44 (2020)
6. Straube, F., Verhoeven, P., Nitsche, B.: Potenzielle Anwendungsgebiete Der Blockchain-Technologie in Der Logistik. *ERP Manag.* **17**, 53–56 (2021)
7. Pisa, M.: Reassessing expectations for blockchain and development. *Innov. Technol. Gov. Globalization* **12**, 80–88 (2018). [https://doi.org/10.1162/inov\\_a\\_00269](https://doi.org/10.1162/inov_a_00269)
8. Clauson, K.A., Breeden, E.A., Davidson, C., Mackey, T.K.: Leveraging blockchain technology to enhance supply chain management in healthcare: an exploration of challenges and opportunities in the health supply chain. In: *BHTY 2018* (2018). <https://doi.org/10.30953/bhty.v1.20>
9. Agbo, C., Mahmoud, Q., Eklund, J.: Blockchain technology in healthcare: a systematic review. *Healthcare* **7**, 56 (2019). <https://doi.org/10.3390/healthcare7020056>
10. Gökalp, E., Gökalp, M.O., Çoban, S., Eren, P.E.: Analysing opportunities and challenges of integrated blockchain technologies in healthcare. In: Wrycza, S., Maślankowski, J. (eds.) *SIGSAND/PLAIS 2018. LNBIP*, vol. 333, pp. 174–183. Springer, Cham (2018). ISBN: 978-3-030-00059-2. [https://doi.org/10.1007/978-3-030-00060-8\\_13](https://doi.org/10.1007/978-3-030-00060-8_13)
11. Haq, I., Muselemu, O.: Blockchain technology in pharmaceutical industry to prevent counterfeit drugs. *Int. J. Comput. Appl.* **150**, 8–12 (2018)
12. Ahmadi, V., Benjelloun, S., Kik, M.E., Sharma, T., Chi, H., Zhou, W.: Drug governance: IoT-based blockchain implementation in the pharmaceutical supply chain. In: *Proceedings of the 2020 Sixth International Conference on Mobile and Secure Services*, Miami Beach, FL, USA, p. 8. IEEE (2020)
13. Manuj, I., Pohlen, T.L.: A reviewer’s guide to the grounded theory methodology in logistics and supply chain management research. *Int. J. Phys. Distrib. Logist. Manag.* **42**, 784–803 (2012). <https://doi.org/10.1108/09600031211269758>
14. Voss, C., Tsiriktsis, N., Frohlich, M.: Case research in operations management. *Int. J. Oper. Prod. Manag.* **22**, 195–219 (2002). <https://doi.org/10.1108/01443570210414329>

**Open Access** This chapter is licensed under the terms of the Creative Commons Attribution 4.0 International License (<http://creativecommons.org/licenses/by/4.0/>), which permits use, sharing, adaptation, distribution and reproduction in any medium or format, as long as you give appropriate credit to the original author(s) and the source, provide a link to the Creative Commons license and indicate if changes were made.

The images or other third party material in this chapter are included in the chapter’s Creative Commons license, unless indicated otherwise in a credit line to the material. If material is not included in the chapter’s Creative Commons license and your intended use is not permitted by statutory regulation or exceeds the permitted use, you will need to obtain permission directly from the copyright holder.





# A Hybrid Structural Interaction Matrix Approach to Prioritise Process Wastes Generated in a Manufacturing Organisation

Olasumbo Makinde<sup>1</sup>(✉), Thomas Munyai<sup>2</sup>, and Edgar Nesamvuni<sup>2</sup>

<sup>1</sup> University of Johannesburg, Johannesburg 2028, South Africa  
olasumbom@uj.ac.za

<sup>2</sup> Tshwane University of Technology, Pretoria 0001, South Africa

**Abstract.** The productivity of a manufacturing organisation is limited by myriads of process wastes generated in this organisation. In light of this, the aim of this study is to prioritise various process wastes generated in a manufacturing organisation. In order to achieve this, on the one hand, a Hybrid Structural Interaction Matrix (HSIM), which is premised on the theory of subordination via systems thinking was deployed to carry out the process wastes pairwise ranking and weighting analysis. On the other hand, the Pareto Chart, was thereafter deployed to ascertain the vital few process wastes contributing to productivity loss experienced in a manufacturing organisation. A case study of the process wastes generated in an Electronic-Product Manufacturing organisation was used to validate the process wastes prioritisation model developed in this study. The result of the HSIM prioritisation analysis revealed that the intensity rating scores of the process wastes; overproduction, excess inventory, defect, motion, transport, waiting and over-processing limiting the productivity of an organisation are 7.53, 4.59, 6.06, 1.65, 3.12, 0.18 and 9 respectively. The result of the validation exercise revealed that transport, excess inventory and defects are the core process wastes that limit the productivity of an Electronic-Product Manufacturing organisation considered in this study. With this approach, operations managers of a manufacturing organisation would obviously reduce errors in the rating of process wastes, which is vital towards achieving continuous productivity improvement and sustainable manufacturing.

**Keywords:** Process Wastes · Hybrid Structural Interaction Matrix · Pareto Chart · Productivity

## 1 Introduction

Manufacturing organisations are tasked with the responsibility of developing suitable production strategies capable of improving their productivity in order to increase their competitiveness. In order to achieve this, innovative manufacturing paradigms such as lean manufacturing (Gupta and Jain 2013; Bhamu and Sangwan 2014), agile manufacturing (Kumar et al. 2019), reconfigurable manufacturing (Goyal et al. 2013; Koren



et al. 2017), and wisdom manufacturing (Barman 2022) have evolved over the years. Hence, on the one hand, manufacturing organisations have tailored their efforts towards producing high quality products that are required by the customers on or before the due date as well as putting at the centre “the voice of the customers” as a major driver towards developing sustainable products required by the customers (Yang et al. 2019). On the other hand, manufacturing organisations have also identified the need to continuously improve the production methods deployed in their organisations, with strategic objectives of exponentially improving value-added activities carried out within their production processes as well as eliminating or reducing to the bare minimum the non-value added activities (i.e. process wastes) present within their manufacturing systems.

The study of Hill (2018) viewed process wastes as activities that add more time and cost to the production activities carried out in an organisation without concrete value generated from these activities towards meeting customers’ products demand. Therefore, systematic elimination/minimisation of process wastes by means of innovative lean and JIT production strategies are critical towards achieving high productivity gains required to foster sustainable manufacturing in various organisations. According to Wahab et al. (2013), the seven categories of process wastes that needs to be eliminated in a manufacturing organisation are over-processing, overproduction, motion, waiting, defect and transportation. Identification of the sources of the process wastes generated in an organisation is critical towards eliminating them. In light of this, the study of Mostafa et al. (2013) identified the use of traditional value stream mapping and dynamic value stream mapping as the techniques that could be used to pinpoint various process wastes present in a manufacturing organisation. In their study, they also revealed that exercise such as establishment of the root causes of process wastes, prioritisation of the various categories of process wastes and selection of appropriate process waste elimination tools, need to be executed after the process waste identification activity, with a view to systematically eradicate the process wastes present in a manufacturing organisation. A lot of literature in the process of prioritising process waste have focused on carrying out this exercise based on frequency of process wastes generated, cost associated with each process waste, ease of detection of each process waste, and ease of removal of the process wastes, and impact of removal of process wastes (Sutrisno et al. 2018, Manninen et al. 2014). To the best of the authors’ knowledge, no literature has focused on prioritising process wastes based on the influence of each process waste on one another in a manufacturing organisation, tailored towards ascertaining the intensity rating of each process waste from a systems thinking perspective.

The study of Ayomoh and Oke (2006) proposed a HSIM methodology that could be used to prioritise factors by means of carrying out factors subordination pairwise analysis, which could thus unveil the hierarchy level of each factor, thereby unveiling the intensity rating of each factor. In light of the lesson learnt from this study, this study intend to deploy the HSIM prioritisation methodology, with a view to ascertain the vital few process process wastes experienced in an electronic product manufacturing organisation. The structure of this paper is highlighted as follows. Section 2 present the HSIM methodology deployed in this study for process waste prioritisation. Section 3 present and discuss the process wastes prioritisation results for an electronic product manufacturing organisation. The last section concludes based on the result obtained in this study and also highlight the future research work.

## 2 Methodology

The process waste prioritisation solution developed in this study commenced by indicating all the process wastes that could be generated in a manufacturing organisation. Thereafter, the HSIM methodology premised on the theory of subordination was deployed in order to interrogate the interactions and dependencies that exist amongst the various process wastes that affect the productivity of an organisation. The HSIM methodology deployed a contextual question that was used to conduct a pairwise assessment of two consecutive process wastes, with a view to develop a Binary Interaction Matrix (BIM) via subordination of a process waste relative to another, during the course of daily manufacturing operation. The contextual question utilised in this research, denoted as  $Q_{ij}$  is presented as follows:

$$Q_{ij} = \begin{cases} 1, & \text{if the influence of process waste } i \text{ on an organisation productivity can be directly influenced by process waste } j \\ 0, & \text{if the influence of process waste } i \text{ on an organisation productivity cannot be directly influenced by process waste } j \end{cases}$$

Mathematically, the generalised form of the contextual relationship can be expressed as:

If  $i \rightarrow j = 1$  then  $j \rightarrow i = 0$  however,

If  $i \rightarrow j = 0$  then  $j \rightarrow i = 0$  or  $j \rightarrow i = 1$ .

On the other hand, the next step of the HSIM methodology is to develop a Hierarchical Tree Structure Diagram (HTSD) for process wastes ranking using the steps highlighted as follows:

- a) Locate the elemental spaces containing “1” in each row of the BIM matrix constructed.
- b) Form subordination by means of arrows to link row elements to their corresponding column elements where  $Q_{ij} = 1$ .
- c) Repeat steps (a) and (b) for the entire BIM matrix.
- d) If an element  $e$  is subordinate to more than two elements, say;  $f, g, h$  e.t.c., and element  $f$  is subordinate to elements  $g$  and  $h$ , reduce the number of arrows by drawing only one arrow from  $e$  to  $f$ ,  $f$  to  $g$  etc.
- e) Repeat step (d) for all identified subordinates, until all subordinates are connected by one arrow line, thus forming a hierarchy.

Furthermore, Eqs. (1) to (3) was used to compute the intensity rating for each process waste.

$$IRPW_i = \frac{N_{spw(i)}}{T_{pw}} \times M_{sr} + \frac{a}{T_{pw}}(M_{sr} - \mu) \tag{1}$$

$$a = N_{spw} + 1, \tag{2}$$

$$\mu = \frac{M_{spw}}{T_{pw}} \times M_{sr}; \tag{3}$$

$N_{spw}$  is the number of subordinate process wastes possessed by a given process waste  $i$ ,  $T_{pw}$  is the total number of process wastes considered in the study,  $M_{sr}$  is maximum scale rating,  $M_{spw}$  is the maximum subordinating process wastes and IRPW is the Intensity Rating score for each Process Waste. The intensity rating solution is premised on the: (i) the results of BIM exercise, which establish the number of subordinate process wastes ( $N_{spw}$ ) that a particular process waste  $i$  possess and (ii) the rating of each process waste on a scale which ranges between a value of 0 and 9 as indicated in the study of Ayomoh and Oke (2006). Therefore, the value of the maximum scale rating (i.e.  $M_{sr}$ ) is 9.

Lastly, Pareto Analysis was conducted based on the intensity rating of each process waste and the frequency of occurrence of each process waste generated in an organisation, with a view to ascertain the vital few process wastes limiting the productivity of an organisation.

The steps deployed to conduct the Pareto exercise are as follows:

- a) Generate a table that would be used to capture the numeric result before proceeding to build the Pareto Chart.
- b) Populate the process wastes and the intensity rating score for each process waste (PWR) in the Table developed in step (a).
- c) Populate the frequency of the occurrence of each process waste (F), obtained at an Electronic Product Manufacturing Organisation considered in this study, in the Table developed in step (a).
- d) Compute PWR.F for each process waste.
- e) Rearrange the process waste name in the descending order of PWR.F.
- f) Rearrange the process waste value in the descending order of PWR.F.
- g) Determine the cumulative PWR.F based on the result of step (f).
- h) Determine the percentage cumulative PWR.F based on the result of step (g).
- i) Develop the Pareto Chart using the results obtained in steps (g) and (h).

### 3 Results and Discussion

#### 3.1 Identified Process Wastes

The process wastes presented in this study, obtained from the literature include: Over-production (O-Po), Excess Inventory (EI), Defect (D), Motion (M), Transportation (T), Waiting Time (WT) and Over-processing (O-Pc).

### 3.2 BIM Results and Discussion

The result of the BIM matrix is depicted in Table 1.

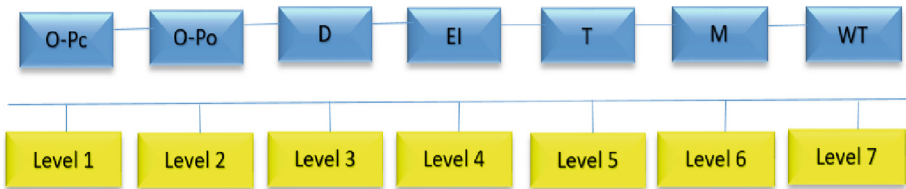
From Table 1, it could be seen that Overproduction (i.e. O-Po) has its effect on productivity directly influenced by process wastes {EI, D, M, T, WT}. In the same manner, excess inventory and defect (i.e. EI and D) are influenced by process wastes {M, T, WT}. Motion (i.e. M) is directly influenced by process waste {WT}. Other process wastes include process Transportation (i.e. T) influenced by process wastes {M, WT}, Waiting Time (i.e. WT), which is not directly influenced by any process waste, and Over-processing (i.e. O-Pc) influenced by process wastes {O-Po, EI, D, M, T, WT}. In light of this, it could be deduced that process wastes O-Po, EI and D respectively have 5, 3 and 4 subordinate process wastes, while process wastes M, T, WT and O-Pc have 1, 2, 0 and 6 subordinate process wastes.

**Table 1.** Pair-wise comparison mapping (i.e. BIM) result for the identified process wastes

i \ j	O-Po	EI	D	M	T	WT	O-Pc
O-Po	0	0	0	0	0	0	1
EI	1	0	1	0	0	0	1
D	1	0	0	0	0	0	1
M	1	1	1	0	1	0	1
T	1	1	1	0	0	0	1
WT	1	1	1	1	1	0	1
O-Pc	0	0	0	0	0	0	0

### 3.3 HSTD Result for Process Wastes

The HSTD result presented in Fig. 1 has seven levels.



**Fig. 1.** HTSD for the prioritised process wastes

As depicted in Fig. 1, Over-processing (i.e. O-Pc) is the most prioritised process waste while waiting time (i.e. WT) is the least prioritised process waste. Overproduction (i.e. O-Po) is a direct subordinate of O-Pc. Machines used in manufacturing organisations in some instances are pushed to operate (i.e. continue processing product) on a full-time shift, with a view to reduce the operations cost incurred by an organisation, thereby resulting into overproduction. As a result of exceeding customers’ expectations,

excess inventories and rejects (to be classified as defect items) could be experienced in an organisation. In addition to this, over-processing of products produced create unnecessary movement of workers to source and transport more unrequired raw materials in producing a product required by the customer. Closely followed, is O-Po. This process waste is on priority level 2. Production of more inventory items than what is needed by the immediate processing workstation could create the holding of excess inventories within these workstations. Therefore, overproduction could promote excessive lead-time, waiting time and storage in an organisation. With overproduction, which promote push system, there is a high chance that defects would not be detected early, hence, promoting high production of defects. In addition, as a result of overproduction, excessive motion and transportation is expected to be experienced in manufacturing organisations.

Next to this process waste is the defect (i.e. D). Defect result into unplanned rework of products, thereby creating an increase in WIP inventories that bring about unnecessary movement of workers during the course of moving defective parts to the rework station. The time spent to rework defective products tends to increase the customer lead time and waiting time as well as increase the waiting time of the WIP items that needs to be processed at the rework station, if the rework station is a multipurpose workstation. Next on the process waste prioritised hierarchy is the excess inventory (i.e. EI). Availability of high amount of WIP inventories in a manufacturing organisation would promote excessive motion and transportation of WIP inventories amidst various workstations, thereby increasing the customer lead time and waiting time. The process waste on hierarchy 5 is transportation (i.e. T). Transportation of WIP items and raw materials amidst various workstations in a manufacturing organisation stimulate a high number of motions exhibited by workers during manufacturing operations. This act result in high waiting time experienced by the WIP inventories, if insufficient material handling system is deployed in a manufacturing organisation.

The process waste on the hierarchy level 6 is motion (i.e. M). Excessive movement of workers amidst various workstations during the production process will increase customer lead time and waiting time. Lastly, waiting time (i.e. WT) is on priority level 7. The influence of all other process wastes high up the hierarchy could influence the customer lead time and waiting time, which could therefore result into low productivity and customer dissatisfaction. In a nutshell, the production of any of these process wastes could on the one hand, result into lower productivity in the case of excess motion, transportation, waiting time, and defects. On the other hand, it could result into production of numerous unwanted inventories that emanates from over-processing (in terms of over-operation) and overproduction.

### 3.4 Intensity Rating Results for Each of the Process Waste

The results of the intensity rating of each process waste, which indicates the degree of contribution of these process wastes towards productivity loss experienced in a manufacturing organisation, calculated using the results obtained in Table 2 and using Eq. (1) is depicted in Table 2.

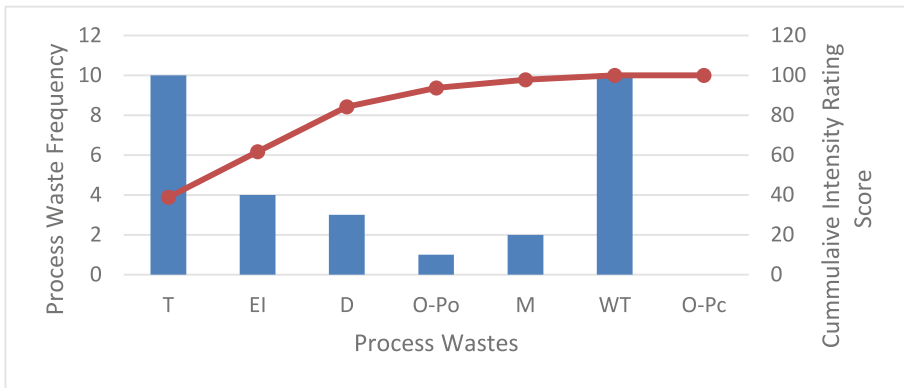
**Table 2.** Intensity Rating for each Process Waste

Process Waste	Rating	Process Waste	Rating
O-Po	7.53	T	3.12
EI	4.59	W	0.18
D	6.06	O-Pc	9
M	1.65		

Based on Table 2, it could be inferred that the intensity rating of the process wastes; O-Po, EI, D, M, T, W and O-Pc are 7.53, 4.59, 6.06, 1.65, 3.12, 0.18, and 9 respectively.

### 3.5 Pareto Analysis of the Process Wastes Generated at an Electronic Product Manufacturing Organisation

The Pareto Chart result, obtained using: (i) the Pareto computation procedure highlighted in the methodology section, (ii) the results presented in Table 2 and (iii) the frequency of process wastes generated at an electronic product manufacturing organisation for a period of one (1) month, which are 3 for D, 4 for EI, 2 for M, 10 for T, 0 for O-Pc, 1 for O-Po and 10 for O-Pc, obtained from the study of Makinde et al. (2022), is graphically illustrated in Fig. 2.



**Fig. 2.** Pareto Chart of the Process Wastes generated at an Electronic Product Manufacturing Organisation

Based on Fig. 2, it could be inferred that 84.29% of the process wastes (i.e. the vital few process wastes) generated in an Electronic Product Manufacturing Organisation considered in this study, are transportation, excess inventory and defects while the remaining 15.71% of the process wastes (i.e. the non-vital process wastes) generated in this organisation are overproduction, motion, waiting time and over-processing.

From this Pareto result, it could be inferred that production managers and decision makers at this Electronic Product Manufacturing Organisation need to focus and concentrate their management efforts more on establishing suitable strategies tailored towards eliminating the aforementioned three (3) critical process wastes, with a view to exponentially improve the productivity of this organisation.

## 4 Conclusion

In view of the need to identify and eliminate process wastes present within a manufacturing organisation, many production managers are forced to explore novel solutions tailored towards improving the leanness of their production processes. In light of this, this study proposed a Pareto-enhanced HSIM technique, which on the one hand, prioritises myriads of process wastes that result into production loss using the principle of subordination, ingrained with Hierarchical Process Waste Tree Structure diagram. On the other hand, it unveiled the vital few process wastes based on the HSIM prioritisation results. The Pareto-enhanced HSIM result deduced that transportation, inventory and defects are the vital few process wastes contributing to the productivity loss experienced in an electronic product manufacturing organisation, used as a case study for this research work. The solution obtained from this study should attract lean manufacturing community since it open up a relatively new area of process waste prioritisation investigated towards promoting the leanness of processes used in manufacturing organisations. Development of a process waste elimination funding model tailored towards improving the productivity of a manufacturing organisation based on the Pareto-enhanced HSIM results should be explored in future studies. Further to this, comparative analysis of the process wastes prioritisation solution of this approach with the process wastes prioritisation solution of the approaches available in the literature need to be explored.

## References

- Ayomoh, M.K.O., Oke, S.A.: A framework for measuring safety level for production environments. *Saf. Sci.* **44**(3), 221–239 (2006)
- Barman, A.: Paradigms of wisdom economy for manufacturing in a post-pandemic world. In: *Green Production Engineering and Management*, pp. 141–159, Woodhead Publishing (2022)
- Bhamu, J., Sangwan, K.S.: Lean manufacturing: literature review and research issues. *Int. J. Oper. Prod. Manag.* **34**(7), 876–940 (2014)
- Goyal, K.K., Jain, P.K., Jain, M.: A novel methodology to measure the responsiveness of RMTs in reconfigurable manufacturing system. *J. Manuf. Syst.* **32**(4), 724–730 (2013)
- Gupta, S., Jain, S.K.: A literature review of lean manufacturing. *Int. J. Manag. Sci. Eng. Manag.* **8**(4), 241–249 (2013)
- Hill, K.: Lean manufacturing: “the seven deadly wastes”: find greater efficiency at every step of the process. *Plant Eng.* **72**(2), 10–12 (2018)
- Koren, Y., Gu, X., Guo, W.: Reconfigurable manufacturing systems: Principles, design, and future trends. *Front. Mech. Eng.* **13**(2), 121–136 (2017). <https://doi.org/10.1007/s11465-018-0483-0>
- Kumar, R., Singh, K., Jain, S.K.: Development of a framework for agile manufacturing. *World J. Sci. Technol. Sustain. Dev.* **16**(4), 161–169 (2019)

- Manninen, S., Pekuri, A., Haapasalo, H.: Using FMEA and AHP methods to prioritise waste types in construction. *Safety* **51**(6), 2–3 (2014)
- Mostafa, S., Dumrak, J., Soltan, H.: A framework for lean manufacturing implementation. *Prod. Manuf. Res.* **1**(1), 44–64 (2013)
- Makinde, O.A., Selepe, R.L., Munyai, T.T., Ramdass, K., Nesamvuni, A.: Improving the supply chain performance of an electronic product manufacturing organisation using DMAIC approach. *Cogent Eng.* **9**(1), 1–29 (2022)
- Sutrisno, A., Gunawan, I., Vanany, I., Asjad, M., Caesarendra, W.: An improved modified FMEA model for prioritization of lean waste risk. *Int. J. Lean Six Sigma* **11**(2), 1–17 (2018)
- Wahab, A.N.A., Mukhtar, M., Sulaiman, R.: A conceptual model of lean manufacturing dimensions. *Procedia Technol.* **11**, 1292–1298 (2013)
- Yang, B., Ying, L., Yan, L., Min, T.: Exploiting user experience from online customer reviews for product design. *Int. J. Inf. Manage.* **46**(1), 173–186 (2019)

**Open Access** This chapter is licensed under the terms of the Creative Commons Attribution 4.0 International License (<http://creativecommons.org/licenses/by/4.0/>), which permits use, sharing, adaptation, distribution and reproduction in any medium or format, as long as you give appropriate credit to the original author(s) and the source, provide a link to the Creative Commons license and indicate if changes were made.

The images or other third party material in this chapter are included in the chapter's Creative Commons license, unless indicated otherwise in a credit line to the material. If material is not included in the chapter's Creative Commons license and your intended use is not permitted by statutory regulation or exceeds the permitted use, you will need to obtain permission directly from the copyright holder.







# Modelling and Simulation of Pump Impeller Produced Using Fused Deposition Modelling

Rumbidzai Muvunzi<sup>1</sup>(✉), Ilesanmi Daniyan<sup>1</sup>, Festus Fameso<sup>2</sup>,  
and Khumbulani Mpofu<sup>1</sup>

<sup>1</sup> Department of Industrial Engineering, Tshwane University of Technology, Pretoria,  
South Africa

MuvunziR@tut.ac.za

<sup>2</sup> Department of Mechanical and Automation Engineering, Tshwane University of Technology,  
Pretoria, South Africa

**Abstract.** Additive Manufacturing (AM) is a key Fourth Industrial Revolution (4IR) technology in which parts are manufactured directly from 3-dimensional models through selective deposition of materials. As a digital technology, AM can be used to produce complex parts that are difficult to make using traditional methods without the need for tooling. Hence, the aim of this study is to investigate the performance of Fused Deposition Modelling (FDM) in the manufacture of pump impellers. This involves performing simulation to test the performance of pump impeller under real-life working conditions at different operating speeds and pressures. The model of the impeller as casted in the FDM process was developed in the complete Abaqus modelling environment. The model part was created as single solid homogenous part with no nodal separations or assembly ties or constraints between the base of the impeller and its blades, in relation to its as-cast manufacturing state. The results obtained showed that extreme operating speeds of up to 1000 rad/s or pressures of 0.22 MPa are not suitable conditions under which the impeller will operate without compromising its efficiency and structural integrity. The study is useful in providing guidance on the application of FDM to produce functional parts. Through the study, the capability of AM as a suitable approach for enabling local sustainable production of spare parts is demonstrated.

**Keywords:** 4IR · AM · FDM · Pump impeller · Simulation

## 1 Introduction

ASTM [1] defines Additive Manufacturing (AM) as a process of joining materials to make objects from 3D models in a layer-by-layer strategy. The design freedom of AM allows engineers to make complex parts that are difficult to produce with traditional methods [2]. As a result, the technology has found application in the aerospace, automotive and medical industries [3]. Compared to conventional manufacturing, AM boasts of freedom of design, flexibility, cost and time effectiveness [4]. Among the different AM

systems, the Fused Deposition Modelling (FDM) is the most common cost-effective and safe technology [5].

The FDM is an AM process involving the use of a filament of a thermoplastic material that is fed through the extruder followed by material deposition and curing in successive layers [6]. The FDM process involves melting a polymeric material, which is extruded and deposited layer by layer to produce the desired component [7]. The manufacturing process of FDM makes the technology easily accessible for small and medium scale enterprises to use it in the manufacture of local products. Existing literature has reported that the use of the FDM technology for the fabrication of hydraulic pump impeller boasts of material, time and cost effectiveness with similar performance to the impeller manufactured conventionally [8, 9]. Although the surface roughness of the impeller poses, a constraint but this challenge can be addressed via post-processing. Much of the studies in literature are focused on the use of experiments to determine optimum parameters for producing parts using FDM. There is limited emphasis on the initial numerical analysis. Hence the study aims to investigate the structural integrity and suitability of FDM-produced pump impellers using numerical analysis. This work contributes in both method and theory to the investigation of the stress, deformation and strain response of the impeller and each blade at different blade position, pressure and rotational speeds. The material considered for the application is tough PLA due to its superior mechanical properties. The study provides an insight into the behaviour of the performance of pump impeller under the required service condition. It is useful in providing guidance application of FDM to produce functional parts. Through the study, the capability of AM as a suitable approach for enabling local sustainable production of spare parts is demonstrated. Furthermore, this study can promote sustainability of the manufacturing process in terms of material, energy, time and cost effectiveness as well as environmental friendliness without compromising the performance of the manufactured impeller.

## 2 Materials and Methods

The component considered in this study for modelling and simulation is the automobile pump impeller. Pumps are vital components of many industrial plants and find applications in a wide range of endeavours from power plants to oil and gas plants to manufacturing plants and water treatment and distribution plants. Thus, the usage, maintenance, and replacement of pump impellers are common operations within these industries which influence their day-to-day running in terms of cost and service-delivery. FDM additive manufacturing process comes with the advantage of ease of manufacturing and replacing impellers in-situ, with less downtime, while staying in touch with the demands of meeting industry targets. However, according to Salifu *et al.* [10], the usage, maintenance and replacement of low-end, low-life components like impellers are based on operation life assumptions and quick-fix ends, which sometimes have detrimental consequences. The advent of advanced computing and computing power over the years for investigating the performance of additively manufactured components have been highlighted [11–13]. Fameso and Desai [14], and Fameso *et al.* [15] encouraged predictive study of the mechanical integrity of additively manufactured components using,

commercial finite element analysis (FEA) codes in modelling and simulating their working operation and condition even before production. The thermomechanical behaviour of the FDM impeller under typical pumping operation condition was determined using ABAQUS CAE/2020 commercial software. The stress and strain distribution across the 3D modelled impeller were evaluated as developed under operating conditions. Since pumps are built to work under different conditions and working temperatures, stresses developed can be as a result of any or a combination of cyclic, centrifugal and thermal loads which must not exceed the limits of the material's mechanical and thermal properties, otherwise increased deterioration rate and eventual failure will be imminent if not inevitable.

## 2.1 Model Development

The mechanical properties of the impeller's material are presented in Table 1. The model part was created as single solid homogenous part with no nodal separations or assembly ties/constraints between the base of the impeller and its blades, in relation to its as-cast manufacturing state.

**Table 1.** Mechanical Properties of PLA

Density (kg/m <sup>3</sup> )	Young's modulus (GPa)	Poisson's ratio	Yield strength (MPa)	Conductivity (W/m.K)	Expansion (1/K)	Specific heat (J/(kg.K))
1240	3.5	0.37	53	0.13	0.00012	1800

3D hexagonal-shaped controlled mesh with advancing front algorithm was used in discretizing the modelled part into finite elements and the convergence in size of the elements was measured based on the thermos-mechanical stresses developed in the part. This was used in determining the mesh size of 5 mm as the most suitable mesh which strikes a balance between computational cost and accuracy. The meshed impeller model had about 7,000 linear continuum hexahedral 8-node brick elements.

## 2.2 Analysis Steps and Loading Conditions

In the analysis of sequential interactions of thermal and mechanical forces on the impeller as carried out in this study, static general and steady state heat transfer steps were created and sequentially invoked. The selection of the thermal and mechanical conditions (temperature, operating speed and pressure) were guided by the existing literature within the context of common applications of the impeller. The novelty of the modelling approach lies in the fact that the thermal analysis was first carried out to compute the heat transfer and all thermal effects of the operating environment on the impeller. The output is stored in a database, which includes the nodal stresses due to heating and changes in temperature. This output database was subsequently invoked as initial conditions for the analysis of mechanical forces in the static general analysis step. This approach is

aimed at improving the precision of investigating the stress, deformation and strain of the impeller and each blade at different blade positions, pressures and rotational speeds.

Thermal interactions were created between the part and its environment. A sink upper design limit temperature of 420 K with film coefficient of 10 kW/m<sup>2</sup>K was applied to the anterior façade of the impeller where the blades interact with the fluid it supplies energy to, while a sink temperature of 298 K with film coefficient of 18 W/m<sup>2</sup>K was applied to the posterior façade which adjourns the external working environment of the impeller. Both temperatures correspond to the operating temperature gradient between the impeller and the fluid on one hand, and the impeller and its outside surroundings on the other hand. The film coefficients also represent the convective coefficients of heat transfer between the impeller and the fluid and air streams respectively.

### 3 Results

The results and superimposed graphical plot of deformation and strains on the impeller at different rotating speeds and a constant operating pressure of 0.11 MPa and at different operating pressures but constant rotational speed are presented in Fig. 1 and Fig. 2.

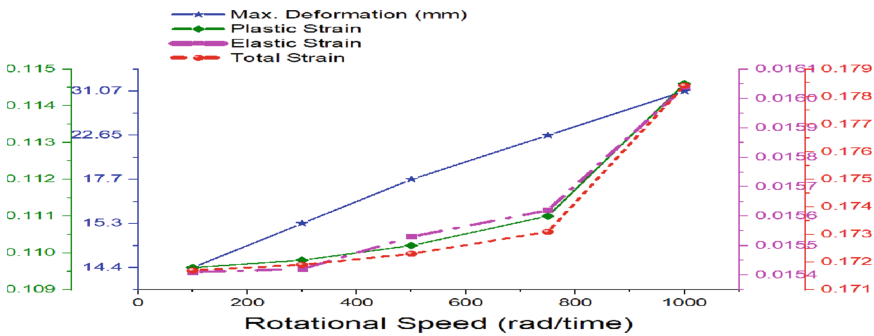


Fig. 1. Deformation and strain of impeller at different rotational speed

It can be observed from Fig. 1, that the impeller experiences increasing strain as its operating speed increases, with the rate of increase in strain maintaining a gentle near-linear profile at speeds of between 200 and 750 rad/s, corresponding to 1,900 rpm to 7,125 rpm, which is within the operating range of most motor vehicles. However, tested at rotational speeds higher than these, the strains experience exponential increase, with a sharp jump in the profile from a gentle slope to a rather steep one, suggesting that operating in this condition will be detrimental to the integrity of the impeller. The result of these increasing strains with operating speed is a continuous increase in the maximum possible deformation that the impeller will experience as a result of a combinations of the rotational body forces and other physical agents associated with its operation in such conditions.

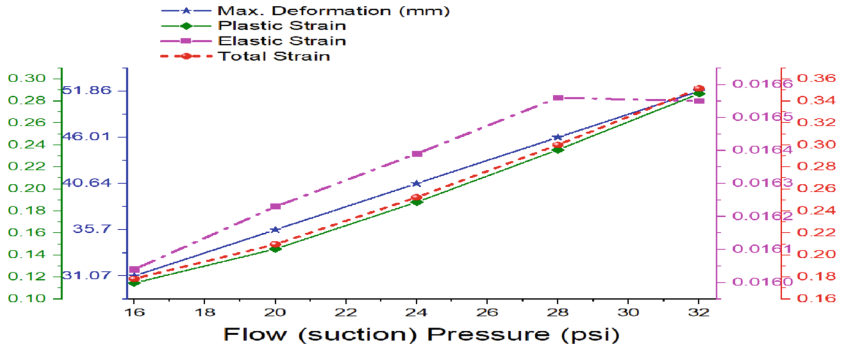


Fig. 2. Deformation and strain of impeller at different pressure

Figure 2 similarly presents increased deformation resulting from the corresponding increase in strains dues to rising operating pressures. The results and contour plot for the stress, deformation and strains on the impeller at the different rotating speeds and operating pressures are presented in Fig. 3.

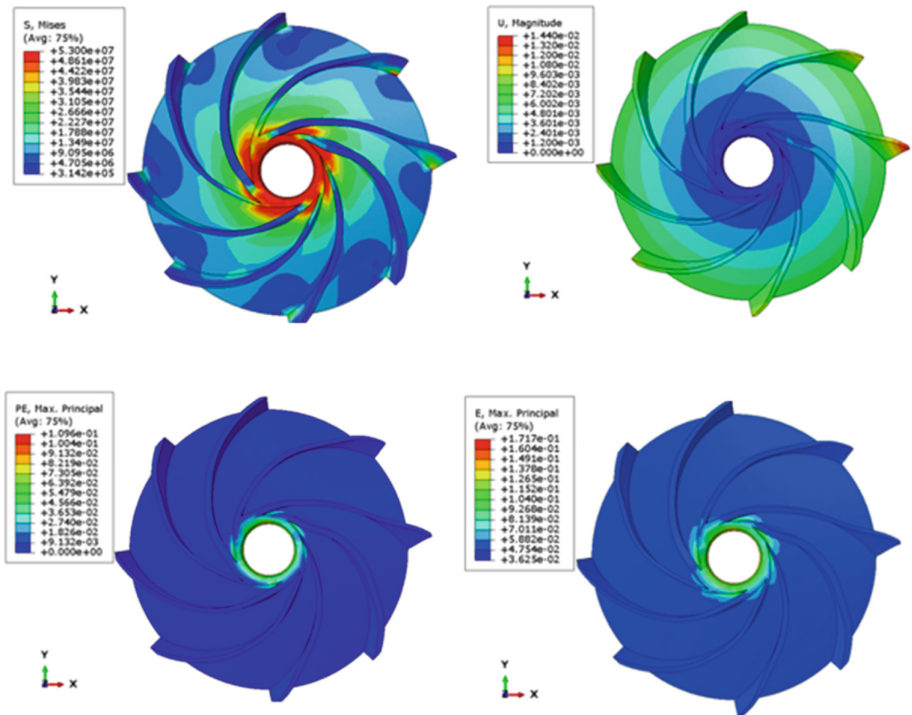
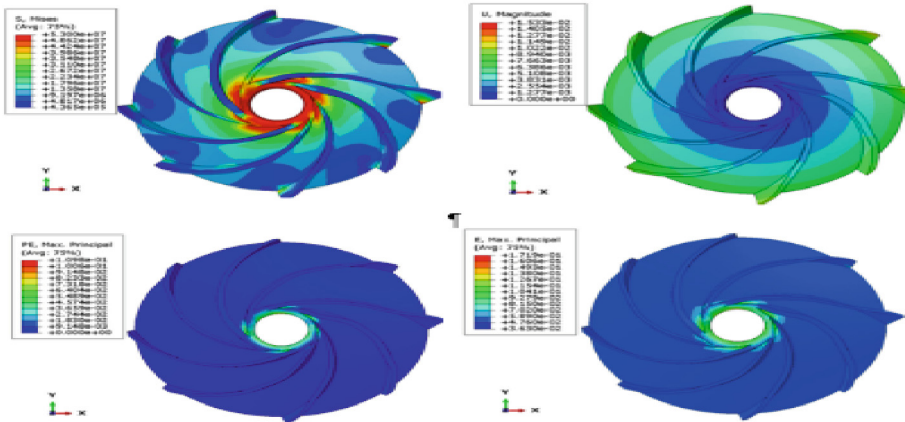


Fig. 3. Stress, deformation and strains on the impeller at rotating speed of 100 rad/sec and operating pressure of 0.11 MPa

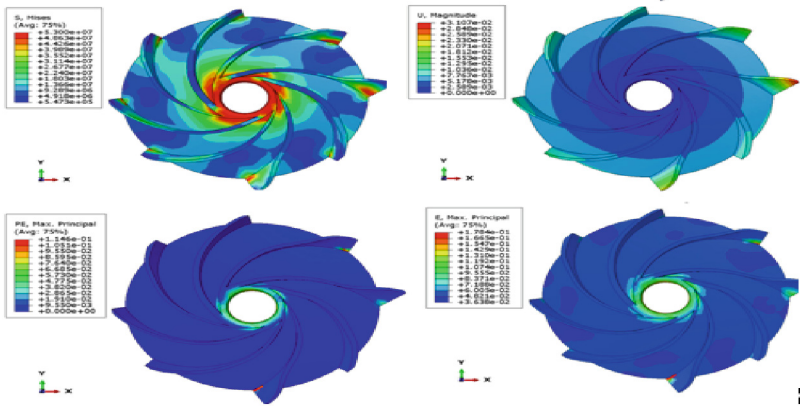
Figure 4 shows that low operating speeds and the relatively lower 0.11 MPa operating pressure, the maximum induced stresses on the blades are going to be below yield, with zero plastic strain experienced. The strains in this region can be managed by mounting dampers that will absorb and reduce these effects.



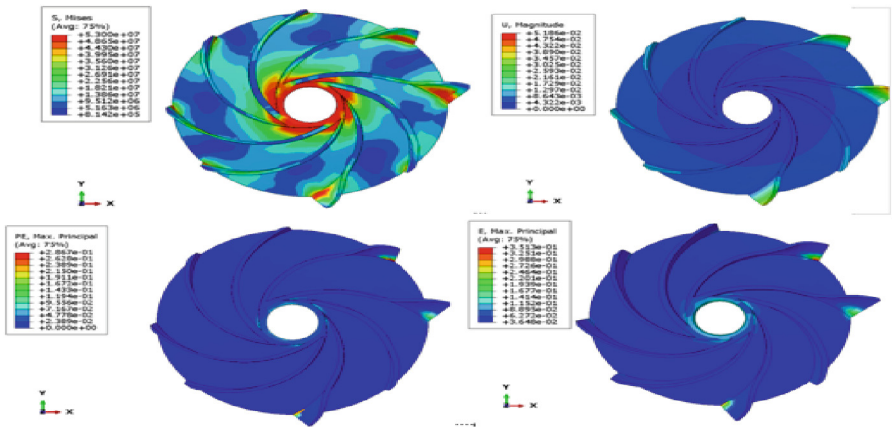
**Fig. 4.** Stress, deformation and strains on the impeller at rotating speed of 300 rad/sec and operating pressure of 0.11 MPa

The bulk of the strains experienced will be elastic strains which will not cause any permanent distortions or damage. All the deformations especially at the leading edges will be recoverable. As expected, the only region of concern will be the groove where the impeller mounts the shaft. The effects of cycling stresses. The distribution profiles at a slightly higher speed of 300 rad/s corresponding to 2850 rpm. However, the gradual commencement of build-up of stresses in beginning to manifest, with a possibility of plastic strain inducing yield at some location on the load bearing leading edge of blade 2. Deformations induced at these conditions are still largely recoverable making it safe still, to be operated under such condition. The effects of ramping up the operating speed to the limits at 1000 rad/s corresponding to 9500 rpm maintained first at 0.11 MPa and then at an upper limit of 0.22 MPa are presented respectively in Figs. 5 and 6.

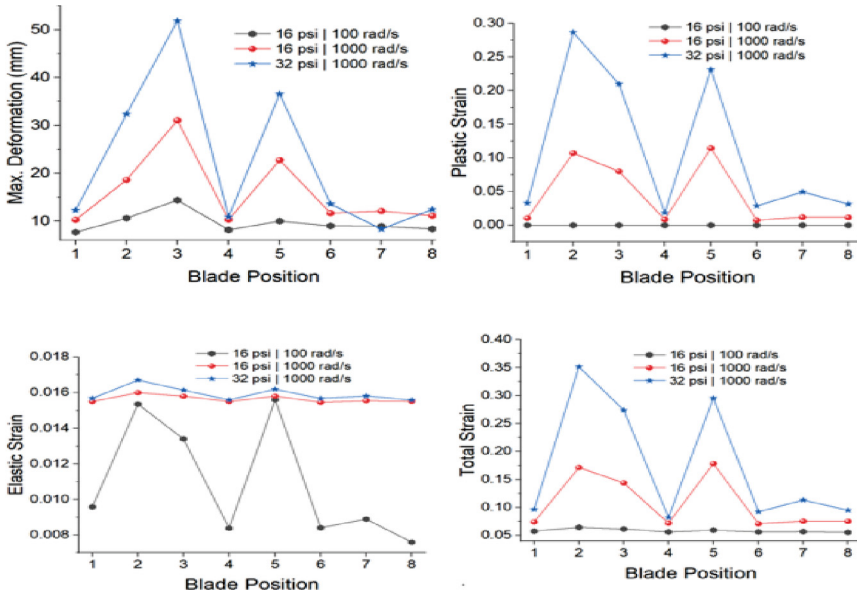
The deformation and strain response of each blade to the conditions highlighted thus far are graphically presented in Fig. 7. In addition, these results have corroborated results presented in earlier, which has revealed that extreme operating speeds of up to 1000 rad/s or pressures of 0.22 MPa are not suitable conditions under which the impeller will operate without compromising its efficiency and structural integrity.



**Fig. 5.** Stress, deformation and strains on the impeller at rotating speed of 1000 rad/sec and operating pressure of 0.11 MPa



**Fig. 6.** Stress, deformation and strains on the impeller at rotating speed of 1000 rad/sec and operating pressure of 32 MPa



**Fig. 7.** The deformation and strain response of each blade at different blade position, pressure and rotational speed

### 4 Conclusion

The aim of this study is to investigate the performance of FDM in the manufacture of pump impellers at different operating speeds and pressures. This was achieved with the aid of modelling and simulation in the Abaqus CAE. 3D hexagonal-shaped controlled mesh with advancing front algorithm was used in discretizing the modelled part into finite elements and the convergence in size of the elements was measured based on the thermo-mechanical stresses developed in the part. It was found that extreme operating speeds of up to 1000 rad/s or pressures of 0.22 MPa were not suitable conditions under which the impeller will operate without compromising its efficiency and structural integrity. The study provides an insight into the behaviour of the performance of pump impeller under the required service condition. It is useful in providing guidance application of FDM to produce functional parts. In addition, this study can promote sustainability of the manufacturing process in terms of material, energy, time and cost effectiveness as well as environmental friendliness without compromising the performance of the impeller manufactured conventionally. Future work can consider the comparative analysis between the numerical results and the actual experimental results, optimisation of the process parameters and the prototyping of the modelled component.



## References

1. ASTM, ASTM F2792–10 Standard Terminology for Additive Manufacturing Technologies (2010)
2. Nikitakos, N.: Additive manufacturing of Spare parts in the Maritime Industry in the digital era, September 2019
3. Pratheesh Kumar, S., Elangovan, S., Mohanraj, R., Ramakrishna, J.R.: Review on the evolution and technology of state-of-the-art metal additive manufacturing processes. *Mater. Today Proc.* **46**, 7907–7920 (2021)
4. Muvunzi, R., Mpfu, K., Daniyan, I.A.: An evaluation model for selecting part candidates for additive manufacturing in the transport sector. *Metals J.* **11**(765), 1–18 (2021)
5. Calignano, F., Manfredi, D., Ambrosio, E.P., Fino, P.: Overview on additive manufacturing technologies. vol. 105, no. 4, pp. 593–612 (2017)
6. Daniyan, I.A., Balogun, V., Mpfu, K., Omigbodun, F.T.: An interactive approach towards the development of an additive manufacturing technology for railcar manufacturing. *Int. J. Interact. Des. Manuf. (IJIDeM)* **14**(2), 651–666 (2020). <https://doi.org/10.1007/s12008-020-00659-8>
7. Gebisa, A.W., Lemu, H.G.: Investigating effects of Fused-deposition modeling (FDM) processing parameters on flexural properties of ULTEM 9085 using designed experiment. *Materials (Basel)* **11**(4), 1–23 (2018)
8. Quail, F., Stickland, M.T., Scanlon, T.J.: Rapid manufacturing technique used in the development of a regenerative pump impeller. In: *World Congress on Engineering*, pp. 1–10. London, England (2009)
9. Fernandez, S., Jimenez, M., Porras, J., Romero, L., Espinosa, M.M., Dominguez, M.: Additive manufacturing and performance of functional hydraulic pump impellers in fused deposition modeling technology. *J. Mech. Des.* **138**, 1–5 (2016)
10. Salifu, S., Desai, D., Fameso, F., Ogunbiyi, O., Jeje, S., Rominiyi, A.: Thermo-mechanical analysis of bolted X20 steam pipe-flange assembly. *Mater. Today Proc.* **38**, 842–849 (2021). <https://doi.org/10.1016/j.matpr.2020.04.882>
11. Muvunzi, R., Mpfu, K., Daniyan, I.A., Fameso, F.: Analysis of potential materials for local production of a rail car component using additive manufacturing. *Heliyon* **8**(e09405), 1–8 (2022)
12. Daniyan, I., Mpfu, K., Daniyan, L., Fameso, F., Oyesola, M.: Computer aided simulation and performance evaluation of additive manufacturing technology for component parts manufacturing. *Int. J. Adv. Manuf. Technol.* **107**(11–12), 4517–4530 (2020). <https://doi.org/10.1007/s00170-020-05340-8>
13. Daniyan, I.A., Oyesola, M.O., Mpfu, K., Adeodu, A.O.: Thermal modelling and simulation of a screw extruder for additive manufacturing technology. In: *Proceedings of the 2nd African International Conference on Industrial Engineering and Operations Management*, Zimbabwe, pp. 53–59, 7–10 December 2020
14. Fameso, F., Desai, D., Kok, S., Newby, M., Glaser, D.: Simulation of laser shock peening on X12Cr steel using an alternate computational mechanical threshold stress plasticity model. *Int. J. Adv. Manuf. Technol.* **111**(1–2), 1–11 (2020). <https://doi.org/10.1007/s00170-020-06079-y>
15. Fameso, F.: Explicit analysis using time-dependent damping simulation of one-sided laser shock peening on martensitic steel turbine blades, vol. 96, no. 12, pp. 927–938, (2020)

**Open Access** This chapter is licensed under the terms of the Creative Commons Attribution 4.0 International License (<http://creativecommons.org/licenses/by/4.0/>), which permits use, sharing, adaptation, distribution and reproduction in any medium or format, as long as you give appropriate credit to the original author(s) and the source, provide a link to the Creative Commons license and indicate if changes were made.

The images or other third party material in this chapter are included in the chapter's Creative Commons license, unless indicated otherwise in a credit line to the material. If material is not included in the chapter's Creative Commons license and your intended use is not permitted by statutory regulation or exceeds the permitted use, you will need to obtain permission directly from the copyright holder.



# **Life Cycle and Decision Making**



# Framework for Sustainability in Aerospace: A Proof of Concept on Decision Making and Scenario Comparison

Marco Franchino<sup>(✉)</sup>

University of Sheffield Advanced Manufacturing Research Centre (AMRC), Sheffield South  
Yorkshire S9 1ZA, UK  
m.franchino@amrc.co.uk

**Abstract.** Aerospace is a large and growing industry currently dependent on fossil fuels. UK aviation has committed to achieving net zero emissions by 2050.

In order for the UK aerospace sector to achieve the sustainability goals, it needs to use the latest technologies while making sure to minimise negative environmental impacts.

Ongoing debates claims that the definition of sustainability and its assessment is vague. Companies struggle with quantifying the return on their sustainability investments and necessitate a methodology to aid decision making and quantify improvements against sustainability and profitability. For that reason, this investigation focused on defining a framework to assess sustainability for aerospace manufacturing following a triple bottom line (TBL): profit, people (social responsibility) and planet.

The author surveyed a range of major aerospace businesses, including Airbus, BAE Systems, Boeing, GKN, Rolls-Royce and Spirit Aerosystems, who are all industrial partners at the University of Sheffield Advanced Manufacturing Research Centre (AMRC). These businesses are all working together to identify and solve the common challenges associated with sustainable manufacturing and contributed their thoughts to the development of this definition.

Collected information has been integrated in a trade study framework that helps scenario comparison and decision making. Discrete Event Simulation (DES) has been used to test the methodology, defining and quantifying alternative scenarios. The framework developed in this study aims to help ensuring that aerospace companies remain profitable whilst also fulfilling the industrial Partners' environmental and societal obligations.

**Keywords:** Sustainability · Decision Making · Aerospace · Discrete Event Simulation · DES · Trade Study · Manufacturing

## 1 Introduction

Worldwide, the aviation industry accounts for around 2% of all human-induced carbon dioxide (CO<sub>2</sub>) production [1]. The international community predicts that global aviation

emissions will grow by an additional 300–700% by 2050 if no effective measures are taken [2].

The UK's aerospace sector is a world leader in developing new technologies and vital to the UK economy. It provides over 120,000 highly skilled jobs and has an annual turnover of £35 billion, the majority of which comes from exports to the rest of the world [3]. Recently, UK aviation has committed to achieving net zero emissions by 2050 [4]. In order for the aerospace sector to maintain its spot and achieve the sustainability goals, it needs the use of the latest equipment and processes while minimising negative environmental impacts and conserving energy and natural resources. Therefore, the aerospace industry needs to identify, quantify, assess and manage the flow of environmental waste/emissions and maximise resource efficiency (i.e. energy, people, time).

However, ongoing debates claims that the definition of sustainability and its assessment is vague leading to significant uncertainties in quantifying the return on sustainability investments [5].

## 2 Mapping Sustainability within Aerospace Industry

### 2.1 Literature Review on Sustainability in Aerospace Industry

Sustainability is the ability to maintain or support a process continuously over time. In industry, sustainability seeks to prevent the depletion of natural or physical resources in order to maintain a healthy environment while preserving a financially and socially viable business.

As a large and growing industry currently dependent on fossil fuels, to meet sustainability targets, the entire Aerospace industry needs to collaborate and coordinate—not just airframe Original Equipment Manufacturers (OEMs), engine manufacturers, and suppliers, but also energy companies, airports, regulators, and other stakeholders [6].

Focusing on manufacturing, there are four types of practices leading to more sustainable development: product modification, product improvement, process modification, and process improvement [7]. Modification implies an alteration in the product or process, while an improvement keeps them the same, but more efficient. The main problem is that assessing a particular activity's contribution to sustainability is difficult for several reasons [8]:

- the concept of sustainability is vast in scope and consequences of some decisions demonstrate over a long time.
- The level of complexity can be very high because of the vast scope to deal with and multiple interactions to consider among economic, environmental and social elements.
- Relations among variables are in most cases dynamic.
- Systems in question often do not exist yet and it may be necessary to investigate the impact of various scenarios or plans on sustainability before actual implementation.
- Different levels of granularity may have to be handled at the same time.

In recent years, a triple bottom line (TBL) approach has become more prominent [9]. TBL posits that instead on one bottom line (profit), there should be three: profit,

people (social responsibility) and planet. The three key principles of TBL should be measured, but they do not, of themselves, provide a measurement system. Therefore, many organisations are developing specific evaluation tools and best practices to help them achieve a suitable balance across Social, Environmental and Economic principles [10]. Currently, aerospace leaders try to touch every aspect of these principles in their operations [11, 12].

To plan and measure sustainability and cope with uncertainties, virtual simulations (e.g. discrete event simulation) are widely adopted. The use of DES plays a pivotal role in designing sustainability related strategies, since it allows the stakeholders to “experiment” what-if scenarios prior to “implementation” [13].

However, a major source of confusion is that the list of requirements used to evaluate alternative scenarios differs from organisation to organisation, leading to omissions, inconsistencies and inaccuracies [5].

## **2.2 An Assessment on Sustainability Aspirations and Strategies of a Selected Subset of AMRC Aerospace Partners**

A survey was circulated across the University of Sheffield Advanced Manufacturing Research Centre (AMRC) aerospace industry partners, including Boeing, Airbus, Rolls-Royce, Spirit AeroSystems, GKN, BAE Systems (and many more) that are currently involved in the grand challenge of sustainable development, to help focus and drive the direction of this project and gauge interest in this activity. The following data was collected:

- opinions on the most important drivers for sustainability in manufacturing processes.
- Ideas on the steps that should be undertaken to improve sustainability in aerospace.
- The technological improvements that responders would like to see to increase sustainability.
- The challenges industry faces in applying sustainability improvement measures.

Most frequent answers highlighted that:

- “Cost”, “waste” and “energy consumption” are the major sustainability drivers and should be tackled to have more sustainable processes.
- “Materials”, “processes” and “energy” are the major focus areas and should be investigated, this includes exploration of novel materials (ideally light weight) and ways to process with them.

The survey analysis emphasised that companies struggle with quantifying the return on their sustainability investments and necessitate a standardised framework methodology to aid decision making and quantify improvements against sustainability and profitability.

It appeared clear that the major questions to be addressed by our research were how to harmonise the requirements used to compare the sustainability scenarios and how the existing methodology (simulations) could be efficiently used towards the creation of such a comparison framework.

### 3 Comparison Methodology: DES and Trade Study

#### 3.1 Introduction

The AMRC’s Manufacturing Intelligence team developed a framework trade study for comparing alternative scenarios, with particular focus on aerospace manufacturing processes, encompassing all the requirements that should be evaluated to assess sustainability.

Measurements were integrated to a Discrete Event Simulation (DES) as a case study to test scenarios. This DES model in conjunction with the Trade Study tool is the framework created to be used in order to make informed decisions based on real data to target more sustainable solutions (e.g. cost, energy, carbon footprint and waste reduction) in the TBL sphere. The developed framework in this study is aiming to help ensuring that Aerospace sector remain profitable whilst also fulfilling environment and societal obligations.

#### 3.2 Trade Study Framework

A trade study (or trade-off study) is a formal tool that supports decision making selection of the best or most balanced solution among the proposed alternatives.

Over the course of recent years reviewing best-practice from a range of projects, the AMRC’s Manufacturing Intelligence team have developed a state-of-the-art trade study process. This enables key stakeholders at the very beginning of a project phase, to have a comprehensive, bias-free understanding of each of the alternative options based on key drivers, and then down-selected the optimum solution for a particular objective. This trade study process has been successfully applied in a number of projects with AMRC’s partners and customers.

Figure 1 shows the main steps to reach decision. Some step may be iterative (e.g. comparing scenarios).

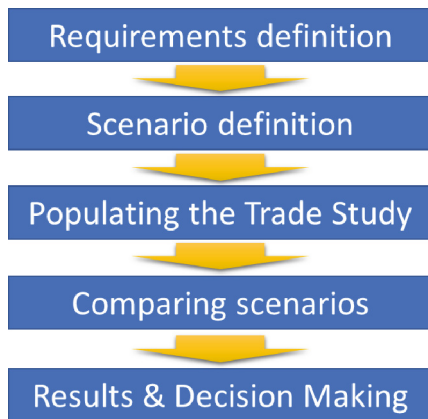


Fig. 1. Decision making steps

### 3.3 Requirements Definition

In order to compare alternatives with particular focus on sustainability, the trade study framework has been populated (Table 1) with requirements defined in accordance with AMRC partners and industry needs, formulated on the base of the data collected during the surveying activity and literature review. Each requirement is composed by a top level (Key Driver) broken down in Key Performance Indicators (KPIs). The key drivers are the main focus areas to be considered.

**Table 1.** Requirements.

Key Drivers	KPIs			
PROCESS	Reconfigurable process	Energy Consumption	Batch size	Inventory / Storage stock
	Technology / Process maturity	Energy Efficiency	Quantity	WIP
	Multi-functional	Area of the process	Product Carbon Footprint	Setup time
	Cycle Time	Operator presence / utilisation	Robustness	Repeatability
	Manual Intervention Time	Future-Proof	Maintenance	Process capability
	Takt Time	End of life	Frequency	Disassembly Effort Index
	Longevity indicator (LI)	Operator safety	Process Modularisation	
PRODUCT	Material design	Recyclability	Cleanliness of product	Contamination of Biological materials
	Product design	Location of material source	Leasing / buy-back schemes	Composition of structural elements ensuring future reusability
	Waste	Disassembly	Use of toxic or hazardous materials	Product Modularisation
FACTORY / INFRASTRUCTURE	Factory planning / shift pattern	Storage facility	Staff costs	Deterioration & Age
	Size	Utility costs	Transport links	Flexibility of the structure
	Location	Labor rates	Utility links	Deterioration
	Complexity	Capex		
SERVICES / RESOURCES	Compressed Air	Power	Consumables	Extraction
	Water	Lighting	Manpower	Chemicals
LOCAL ENVIRONMENT	Operator well-being	Air Quality	Pollution / Emissions	
	Noise	Light	Environmental risk	
	Vibration	Heat	Operator safety	

### 3.4 Populating the Trade Study Framework

KPIs receive an importance score from 1 (low importance) to 7 (critical importance). This is used to correct the performance score assigned to an alternative adjusting the results depending on KPIs’ importance. In order to drive the comparison in term of sustainability, the higher is the sustainability implication, the higher is the importance, therefore, for example, KPIs like “energy consumption” or “recyclability” have “7” as importance score. Importance scores may be different depending on project/customer requirements, an investigation with stakeholders is encouraged to properly set the scores at the beginning of any application.



Alternative scenarios receive performance scores against each KPI. These scores may have different nature, quantitative, qualitative, or opinion-based, depending on the availability, maturity of the baseline and scenarios. The easiest way to score is using a scale from 1 (really poor performance) to 10 (outstanding performance). The different scenarios are modelled with the aid of DES to quantify differences.

For real-world industry applications, it is advisable to use quantifiable and measurable data wherever possible (e.g. energy consumption in KWh, energy costs in £), these are automatically converted through a scaling system in values from 1 to 10 to aid comparison. However, the direct application of values on scales from 1 to 10 is always possible for qualitative or opinion-based data. Additional Key Drivers and KPIs could be added in case is necessary for specific applications. Furthermore, the framework allows to switch off requirements if data are unavailable or not applicable.

### 3.5 Comparing Scenarios and Results

DES is commonly used to test, monitor and predict the behaviour of a manufacturing production process giving the user the possibility to change the system (e.g. workflow) to see results before applying a modification to a real factory environment. With this logic, once a baseline mirroring, for example, a production facility is built, it can be used to optimise a series of factors (e.g. throughput).

Data capture is the key part of the project as this directly influences the accuracy of the simulation model. The AMRC has created a generic model to experiment different scenarios and defined the following data set, which is needed to drive the DES model: process-flows, cycle-times, operators, shift-patterns, buffers/store areas.

In order to test the methodology, a baseline and 3 alternatives have been used. These are speculative scenarios, not linked to a real-world manufacturing process but a simple exemplary representation based on project experience (Fig. 2).

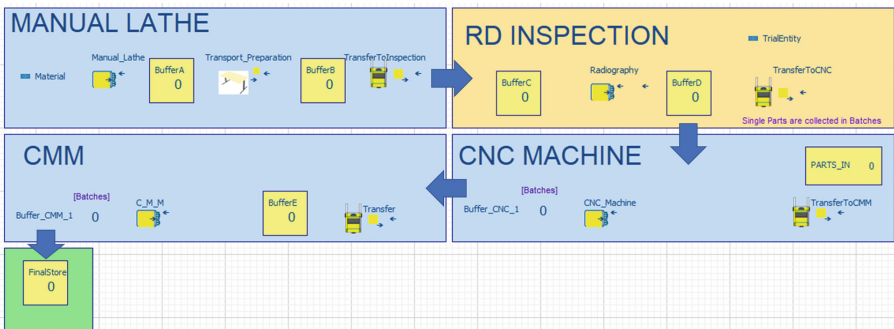


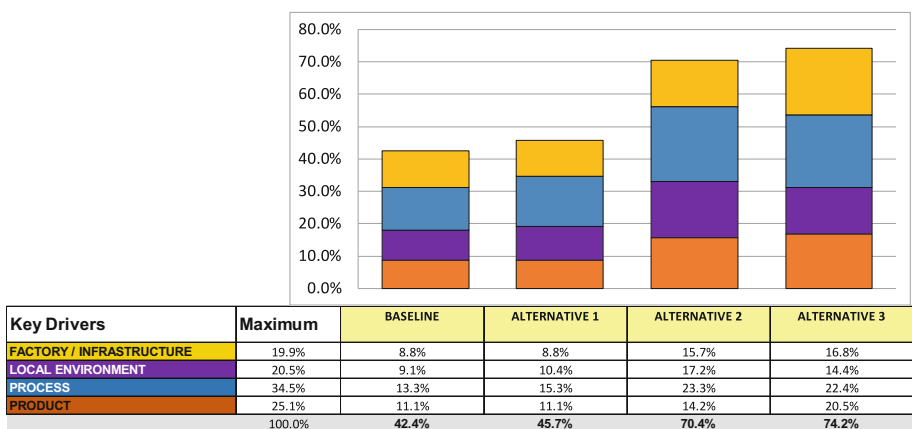
Fig. 2. Discrete Event Simulation model

Lanner Witness DES software was used to simulate the scenarios. The baseline was a simple manufacturing route to produce aerospace metallic components across 4 manufacturing areas: manual lathe, RD (radiographic) inspection, CNC (computer numerical control) machine and CMM (coordinate measuring machine). Improvement scenarios

used different batch sizes and improved cycle-times/resource allocation. A change in design, resulting in reduced waste for the product, was considered for Alternatives 2 and 3 resulting in even more appealing solutions as shown in Fig. 3. For instance:

- Alternative 1 – reduction of cycle-times by 5%
- Alternative 2 - reduction of cycle-times by 10%, change in component design to target waste reduction by 2%
- Alternative 3 - reduction of cycle-times by 12%, change in component design to target waste reduction by 6%

Key drivers of “Product”, “Process”, “Local Environment” and “Factory Infrastructure” have been evaluated reflecting the improvements. Scores have been calculated using a scale from 1 to 10 based on the alternatives’ values. The performance score used for the baseline scenario was “5” (considered average). Analysis showed that the alternatives resulted better than the baseline, with Alternative 2 and 3 performing significantly better (Fig. 3). The bar breakdown shows the performance results against specific drivers for each alternative scenario. Sustainability performance is highlighted in Table 2.



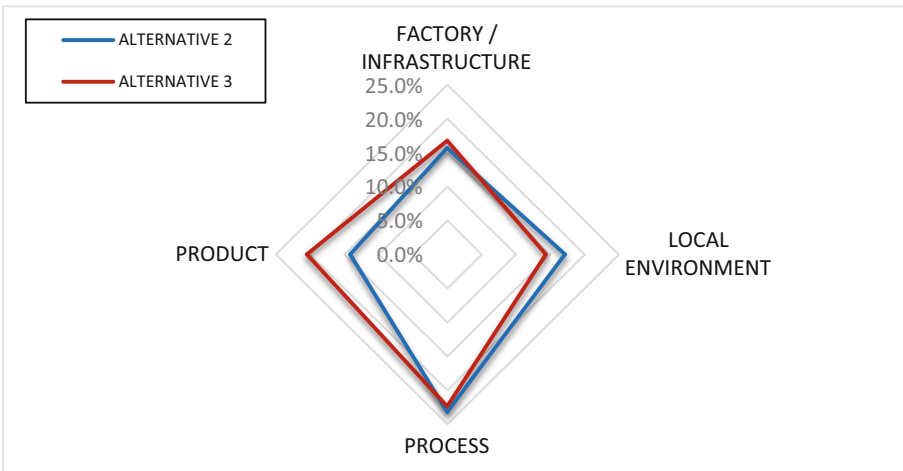
**Fig. 3.** Scenario comparison (scores normalised on a scale 0%–100%–100% being the maximum achievable cumulative score)

It is important to notice that best overall alternative may perform worse against specific drivers as highlighted in both Table 2 and Fig. 4. For instance, Alternative 3 had overall the best cumulative score but Alternative 2 was better for “Local Environment” and slightly better for “Process”. Specifically, reduction of cycle-times by 12% on Alternative 3 resulted in a slight increment in energy consumption (worse score for “Process” in comparison with Alternative 2) and more manual operations (reduced operator well-being and therefore reduced score for “Local Environment”). Before eventual adoption, it is worth to quantify in detail why Alternative 3 is worse in those areas and what can be done to eventually increment the scores.

Although this example is quite simple, in real-world cases the level of complexity can be very high, with multiple interactions, often dynamic, among the KPIs. The framework is thought to capture all these interactions and investigate the impact of various scenarios before application.

**Table 2.** Scenario comparison: Sustainability performance (improvement on baseline).

	Alternative 1	Alternative 2	Alternative 3
<b>FACTORY / INFRASTRUCTURE</b>	0.0%	+5.6%	+6.0%
<b>LOCAL ENVIRONMENT</b>	+1.3%	+8.1%	+5.3%
<b>PROCESS</b>	+2.0%	+8.4%	+8.3%
<b>PRODUCT</b>	0.0%	+3.0%	+9.4%
	<b>+3.3%</b>	<b>+25.2%</b>	<b>+28.9%</b>



**Fig. 4.** Best alternatives comparison

### 4 Conclusions

The following objectives were reached by the research described in this paper:

- main sustainability drivers, focus areas and current issues in sustainability assessment were identified collecting information from industrial experience and AMRC’s Aerospace partners.
- Major objectives for the sustainability improvement efforts were highlighted.
- A framework encompassing trade study analysis and DES modelling was generated, capturing all relevant aspects in form of requirements to compare alternative scenarios, with particular focus on aerospace manufacturing processes.

- This framework has been tested on speculative scenarios to highlight the methodology capabilities.

The long-term aim is to apply the framework developed to case studies and projects to highlight sustainable solutions, quantify improvements and justify decisions.

This has the objective of addressing one of the major findings from the surveying activity within the aerospace sector: quantifying the return on sustainability investments and the necessity to aid decision making and quantify improvements against sustainability and profitability.

Further engagement with AMRC relevant partners and industry collaboration will be vital for the successful application of the described framework methodology. Dissemination of the work undertaken in this project will be part of the first step to gauge major interest and spark further discussions towards more sustainable solutions.

## References

1. ATAG (Air Transport Action Group). [www.atag.org/facts-figures.html](http://www.atag.org/facts-figures.html). 01 Nov 2021
2. IATA (International Air Transport Association). [www.iata.org/en/pressroom/2021-releases/2021-10-04-03/](http://www.iata.org/en/pressroom/2021-releases/2021-10-04-03/). 21 Oct 2021
3. UK Government. [www.gov.uk/government/publications/aerospace-sector-deal/aerospace-sector-deal](http://www.gov.uk/government/publications/aerospace-sector-deal/aerospace-sector-deal) 12 Feb 2022
4. Sustainable aviation. [www.sustainableaviation.co.uk/news/uk-aviation-industry-strengthens-commitment-to-achieving-net-zero-and-launches-first-interim-decarbonisation-targets/](http://www.sustainableaviation.co.uk/news/uk-aviation-industry-strengthens-commitment-to-achieving-net-zero-and-launches-first-interim-decarbonisation-targets/). 20 Mar 2020
5. Young, B.: Moon: simulation modeling for sustainability: a review of the literature. *Int. J. Sustain. Eng.* **10**(1), 2–19 (2016)
6. “The Sustainability Opportunity for Aerospace,” November 2020. <https://www.bcg.com/publications/2020/sustainability-opportunity-for-aerospace-industry>
7. Romaniw, Y., Bras, B.: Survey of common practices in sustainable aerospace manufacturing for the purpose of driving future research. In: Dornfeld, D., Linke, B. (eds.) *Leveraging Technology for a Sustainable World*. pp. 485–490. Springer, Berlin (2012). [https://doi.org/10.1007/978-3-642-29069-5\\_82](https://doi.org/10.1007/978-3-642-29069-5_82)
8. Singh, R.K., Murty, H.R., Gupta, S.K., Dikshit, A.K.: An overview of sustainability assessment methodologies. *Ecol. Indic.* **15**(1), 281–299 (2012)
9. Elkington, J.: Towards the sustainable corporation: win-win-win business strategies for sustainable development. *Calif. Manage. Rev.* **36**, 90–100 (1994)
10. Hallstedt, S.: Sustainability criteria and sustainability compliance index for decision support in product development. *J. Clean. Prod.* **140**, 251–266 (2017)
11. Bertoni, M., Hallstedt, S., Isaksson, O.: A model-based approach for sustainability and value assessment in the aerospace value chain. *Adv. Mech. Eng.* **7**(6), 1–19 (2015)
12. Davis-Mendelow, S.: Sustainability for a change: an aerospace perspective. In: 2006 IEEE EIC Climate Change Conference (2006)
13. Golroudbary, S.R., Zahraee, S.M., Awan, U., Kraslawski, A.: Sustainable operations management in logistics using simulations and modelling. In: 14th Global Congress on Manufacturing and Management (2018)

**Open Access** This chapter is licensed under the terms of the Creative Commons Attribution 4.0 International License (<http://creativecommons.org/licenses/by/4.0/>), which permits use, sharing, adaptation, distribution and reproduction in any medium or format, as long as you give appropriate credit to the original author(s) and the source, provide a link to the Creative Commons license and indicate if changes were made.

The images or other third party material in this chapter are included in the chapter's Creative Commons license, unless indicated otherwise in a credit line to the material. If material is not included in the chapter's Creative Commons license and your intended use is not permitted by statutory regulation or exceeds the permitted use, you will need to obtain permission directly from the copyright holder.





# Environmental Assessment of Recycled Petroleum and Bio Based Additively Manufactured Parts via LCA

Christian Bay<sup>1</sup>(✉), Niko Nagengast<sup>1</sup>, Hans-Werner Schmidt<sup>2</sup>, Frank Döpfer<sup>1</sup>, and Christian Neuber<sup>2</sup>(✉)

<sup>1</sup> Manufacturing and Remanufacturing Technology and Research Center for Additive Innovations, University Bayreuth, Universitaetsstrasse 30, 95447 Bayreuth, Germany  
christian.bay@uni-bayreuth.de

<sup>2</sup> Macromolecular Chemistry, University of Bayreuth, Universitaetsstrasse 30, 95447 Bayreuth, Germany  
christian.neuber@uni-bayreuth.de

**Abstract.** Additive Manufacturing (AM) as much as sustainability aspects gained increasing attention in the last couple of years. The vision of resource-efficient manufacturing at batch size one is often claimed as an outstanding property of AM. Fused Filament Fabrication, as one of the most used AM technologies, satisfies this statement only in a restricted sense, through simple handling for non-experts and low-cost materials and machines. Next to performance-driven and process-influencing attributes, the question of a general ecological improvement through thermo-mechanical recycling rises. Therefore, recycling options of the thermoplastics are mandatory to explore. Based on the ISO 14040/44 Life Cycle Assessment (LCA) methodology two different geometries were environmentally assessed during a primary process cycle, using, and recycling. Each geometry was manufactured by a bio-based polymer and internationally produced (PLA) and petroleum-based locally produced polymer (PP) with a corresponding support filament. The methodological approach demonstrates an option how to evaluate the field of AM and recycling regarding environmental aspects. Furthermore, an adaptation of the sensitivity towards industrial parameters (material/energy efficiency) showed an ecological benefit concerning recycling.

**Keywords:** AM · LCA · Thermo-mechanical Recycling · PP · PLA

## 1 Introduction

**Initial Situation.** Based on a layer-wise material application, Additive Manufacturing (AM) technologies are considered as an appropriate supplement to conventional manufacturing. The steady development of its hard- and software led to a decrease of machines and material investment. The potential around AM seems promising [1, 2]. The AM technology Fused Filament Fabrication (FFF) is characterized by a strand-by-strand positioning of a melted filament through an extruder-nozzle. FFF often sell the image of an ecological conscious technology [3].

© The Author(s) 2023

H. Kohl et al. (Eds.): GCSM 2022, LNME, pp. 669–677, 2023.

[https://doi.org/10.1007/978-3-031-28839-5\\_75](https://doi.org/10.1007/978-3-031-28839-5_75)

**Current Problems.** Manufacturing actions are responsible for about 19% (2010) of global greenhouse gases (GHG) [4]. The plastic industry alone emits 8% of all produced GHGs through raw material extraction and energy demand of processing technologies [5]. Annually, 367 Mio. t (2020) of plastic components are produced [6], whereas only 30% of the produced plastic waste are recycled in the European Union. The problems are often referred to a low quality and high price of recycled products, as much as difficulties in systematic collection and sorting processes [7].

**Aim of Research.** Closing the gap between ecological assessment and recycling of AM products, quantitative ecological assessment via LCA and thermo-mechanical recycling is implemented. The primary and secondary production (via FFF) is conducted with a bio based internationally produced (PLA) and a petroleum based locally produced (PP) filament for a simple cuboid geometry and additional support structure for a complex blade geometry. In terms of industrial scaling, a sensitivity analysis in consideration of an increased material, process, and energy efficiency is executed.

## 2 State of the Art

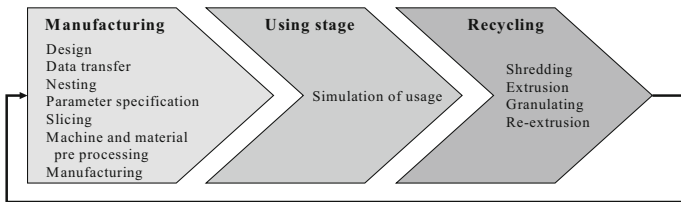
There is a growing interest in the research landscape regarding recycling in terms of waste management, recycling technologies, and recyclability of materials [8, 9]. Despite issues in relation to varietal purity and degradation, thermo-mechanical recycling seems the most promising recycling strategy for mass-focused processing of polymers [10]. Various studies were conducted about the recycling of PLA [11, 12] and PP [13, 14] in the AM context. Primarily, they focus on performance-driven parameters. Most of research regarding AM document technological and economic advantages [15], whereas most of the specific ecological aspects are discussed qualitatively [3, 16], like resource-efficiency, material reduction, minor waste production and production decentralization. A method for ecological assessment is the LCA (ISO 14040/44) [17]. It contains a complex framework for addressing an ecological process analysis and refers to environmental impact indicators [18]. The general integration of LCA in the AM context is proposed in several studies [19, 20], whereas most of the work is presented in specific subfields: There are different research papers concentrating on the energetical characterization [21], hazardous emissions [22], and different applications like automotive [23] and the comparison of conventional and AM manufacturing technologies [24].

### 3 Materials and Methods

The LCA was executed for a bio based PLA (*Premium PLA* from *Raise3D*) with petroleum based PVA (*Aquasolve* from *FormFutura*) and petroleum based PP (*P-filament 721 natural* from *PPprint*) with the *P-support 279* from *PPprint*.

#### 3.1 Manufacturing, Using State and Recycling Process

The LCA is based on a referenced material extrusion manufacturing process, a simulated using stage and the recycling process (see Fig. 1).



**Fig. 1.** Manufacturing, using stage and recycling process

**Manufacturing.** The following manufacturing parameters were set on a *Raise 3D E2*: Extrusion temperature: 210 °C; print bed temperature: 70 °C; printing speed: 30 mm/s; part infill: 50%; layer height: 0.2 mm; extrusion: 100%.

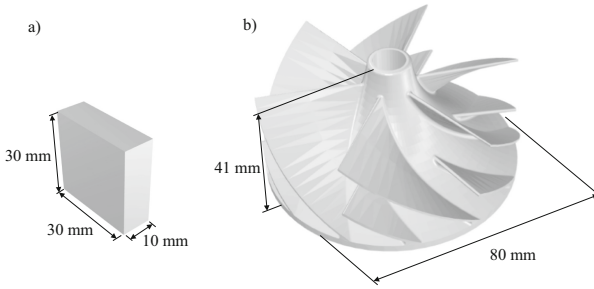
**Using Stage.** The using state was simulated according to ASTM F1980–16 [25]. The specimens of PLA and PP have been conditioned for 14 days with a temperature of 60 °C and a relative humidity of 7.8% in a *Carbolite Recirculating drying cabinet PF*. These conditions correspond to a usage of about half a year under normal temperature (25 °C). Mechanical loads, potential containments and wear were not simulated.

**Recycling.** For shredding the specimens the *SHR3D IT* from *3devo* was used. The PLA flakes were conditioned in a vacuum oven at 60 °C for 24 h before the extrusion process. The *Next 1.0 - advanced extruder* from *3devo* was used with following specifications: extrusion speed: 3 rpm; ventilation: 25%; heating element 1 temperature: 140 °C; heating elements 2–4 temperature: 180 °C.

#### 3.2 Specimens

For executing the LCA with an applied and industrial-linked purpose, two different specimens were used Fig. 2.





**Fig. 2.** Cuboid (a) and impeller (b) specimens

### 3.3 Life Cycle Assessment (LCA)

The impact of the processes in terms of ecological aspects was assessed with a standardized LCA acc. to ISO 14040/44 [17]. The methodical procedure proceeded via target and scope definition to data collection in the inventory analysis (Life Cycle Impact Analysis, LCIA). The developed LCA model is shown in Fig. 3 as a reference flow of the functional units (specimens). The foreground system includes all processes that were practically carried out and accompanied within the scope of this work. For conducting the LCIA as a step of the LCA, the *ReCiPe Endpoint Method* was selected [26]. As credibility reference the *Impact 2002 + LCIA* method was applied additionally.

### 3.4 Life Cycle Impact Analysis (LCIA)

The reference flow of the functional unit was broken down into the individual processes and the input and output resources supplied and discharged were listed for each process unit. Primary processes are located in foreground system, whereas non-specific processes and background processes are located in background system.

**Origin Material Production.** The data collection regarding primary material production (PP & PLA) was taken from the *ecoinvent 3.1* database of the LCA software *SimaPro 9* and literature sources. Due to lack of availability of data on PVA granules, polyvinyl chloride (PVC) granules have been used as a substitute material, with the compromise of the missing saponification process. 5% material loss and energy consumption of 1 kWh/kg were assumed [27].

**Transportation.** The following transportation settings for PLA were calculated from production facility – container port – container port – parcel hub – final target: (Shangahi, CHN): 329 km (truck Euro 3) – (Hamburg, GER): 19,979 km (trans ocean tanker) – (Feucht, GER): 621 km (truck Euro 6) – (Bayreuth, GER): 79 km (truck). The following transportation settings for PVA were calculated from production facility – parcel hub – final target: (Nijmegen, NL) – (Feucht, GER): 573 km (truck Euro 6) – (Bayreuth, GER): 73 km (truck). The following transportation settings for PP were calculated from: production facility – distribution center – final target: (Frankfurt, GER) – (Bayreuth, GER): 280 km (truck Euro 6) – (Bayreuth, GER): 4 km (truck Euro 6).

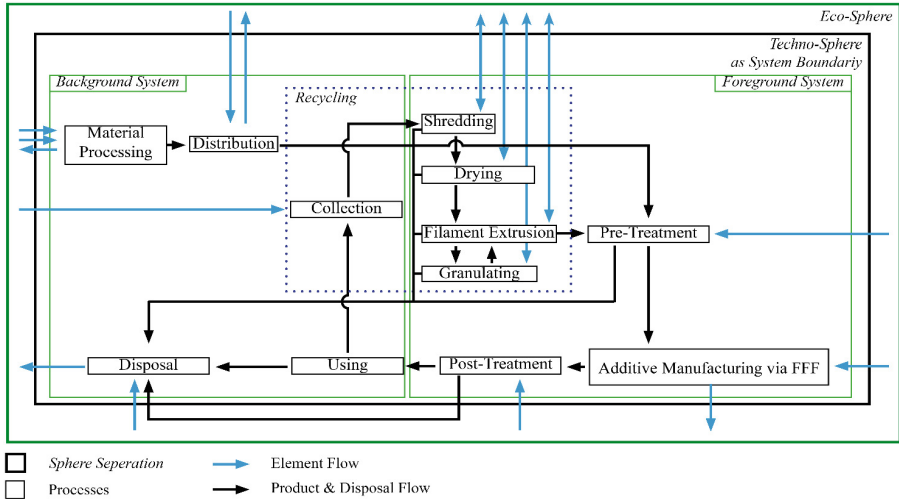


Fig. 3. LCA process flow for circular production of extrusion-based AM

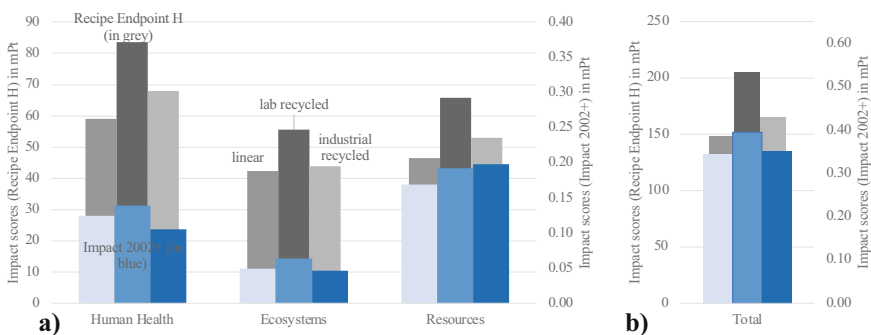
**Materials and Process.** The data for the packaging of the primary materials was taken from *ecoinvent 3.1* and it was assumed that the packaging was disposed of in the general household waste. For pre-processing, PLA was conditioned for 24 h and 60 °C in an oven. For pre-treatment, the print bed was cleaned with 2 mL petroleum based cleaner (*Pcleaner 298* from *PPprint*). Due to the energy consumption (<0.001 kWh), the slicing process was not added to the calculation. The rubber mat was cleaned with 2 mL of cleaning gasoline. To remove the PP support structure, the specimen were placed in a drying oven at 110 °C for 6 h. The removal of the PVA support was realized by placing the impeller in a covered water bath (1 L) for 24 h.

**Recycling.** Before and after the shredding process, the material was weighed and the difference documented as the amount lost and added to disposal. The lab recycling focuses on performance, rather than resource efficiency. This results in more process steps per functional unit, less material and energy efficiency. The industrial recycling follows an economical focus with large-sized machinery. Therefore, the material efficiency is higher and less energy per functional unit is needed. Industrial recycling is composed of an assumed 5% material loss and energy consumption of 1 kWh/kg [27]. Multiple extrusion cycles, re-granulation and cleaning were neglected.

**Deposition.** All loss and waste materials were declared as general household waste. The water-soluble polymer solution was also counted among them due to its disposal in canisters. The disposal scenario included the packaging, cleaning, and material losses. Waste disposal was performed by transporting waste from University of Bayreuth to Schwandorf (108 km) with a vehicle (truck Euro 6) is assumed.

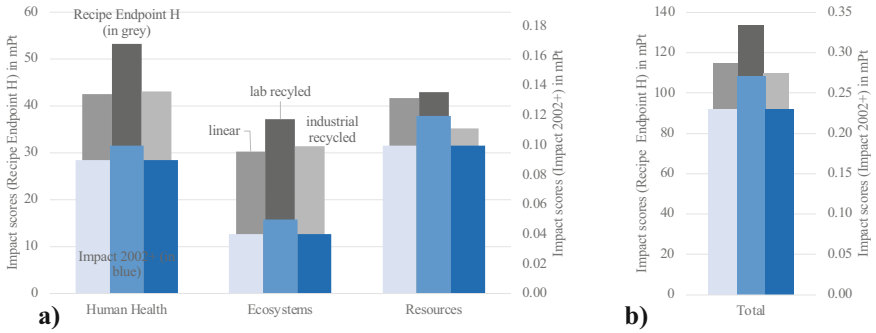
## 4 Results and Discussion

Without focusing on performance or process-influencing properties, all filaments were suitable for reproduction. In order to the guidelines of Life Cycle Interpretation acc. *Haunschild et al.* [28], it is attempted to identify the significant issues, evaluate the completeness, sensitivity, and consistency and deliver limitations and recommendations of the investigated product and process. All processes including pre-treatment, part fabrication, and post-treatment contain no significant differences in consideration of the same functional unit with the same polymer. These processes can be considered as the most resource-demanding processes and therefore have got the biggest impact on the life cycle. In terms of the PLA cuboid, the extra conditioning of the PLA flakes before the extrusion process and the actual recycling process in form of shredding and extruding surpass (transportation and distribution) the virgin production in all three impact factors (see Fig. 4). As a reference, the linear production was calculated to 148 mPt. The recycling of the PLA cuboid in laboratory (205 mPt) and industrial scale (165 mPt) led to an increase of 37.8% respectively 11.4%. A second LCIA method (Impact 2002 +) confirms the result with a magnitude of 0.344 mPt of the primary process in respect to the 0.395 mPt resp. 0.350 mPt. Due to the absence of the energy-demanding conditioning process and the significantly increased resource efficiency of the simulated industrial scaling an improved impact behaviour of recycled PP with the cuboid specimen could be shown (see Fig. 5). Furthermore, the additional granulating and extrusion process, due to the lack of reprinting qualities at laboratory scale were neglected at the LCA execution at industrial scale.



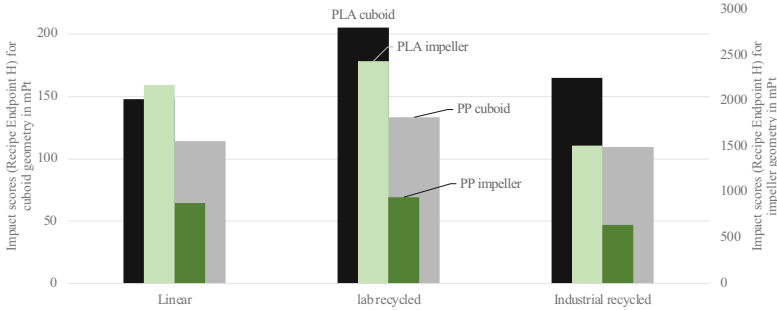
**Fig. 4.** a) Impact scores and indicators for Recipe Endpoint H (grey) and Impact 2002 + (blue); PLA cuboid; b) total impact scores.

This is quantified through the lowest impact score of industrial recycled PP (110 mPt) in comparison to linear PP (115 mPt/ + 4.32%) and lab recycled PP (133 mPt/ + 21.5%). The Impact 2002 + LCA pointed out a similar tendency with 0.231 mPt for linear and industrial recycled PP and 0.273 mPt for lab recycled PP (see Fig. 5).



**Fig. 5.** a) PP Impact scores and indicators for Recipe Endpoint H (grey) and Impact 2002 + (blue); PP cuboid; b) total impact scores.

Despite the higher impact (PLA: 2,429 mPt; PP: 947.6 mPt) of the lab recycling, with industrial recycling, the impact of the PLA impeller linearly produced (2,171 mPt) can be reduced by 30.6% to 1,506 mPt and the virgin PP impeller (879.5 mPt) by 26.6% to 645.5 mPt. The calculation with Impact 2002 + for the linear/lab recycled/industrial recycled impeller yielded in similar results for PLA: 6.2 mPt/6.9 mPt/3.2 mPt and for PP: 1.8 mPt/1.6 mPt/1.1 mPt (see Fig. 6).



**Fig. 6.** Comparison of LCIA impact scores for PLA (left columns) and PP (right columns)

## 5 Conclusion

The results show a tendency of the environmental potential of recycling in consideration of extrusion-based production applications regarding human health, ecosystems, and resources. This potential can mainly be exploited if the recycling process is executed at industrial scale esp. with PP. The scaling approach shall elucidate the improved process efficiency regarding materials and energy. Furthermore, the LCA showed that the environmental impact of the petroleum-based PP is significantly lower than with PLA. These differences mainly result from the raw material extraction, energy demands between the varying processes and the waste generation. Furthermore, the recycling of

PP and PP support filament led to a waste decrease of approx. 50% regarding the PP impeller. The simulated scaling also showed the decrease of single processes. In general, a scaling of the components mass- and complexity-wise showed the potential of resource-optimized industrial recycling in respect of energy and waste reduction. The industrial recycling demonstrated the sensitivity in energy and waste aspects for the investigated pre- and post-processes. Otherwise, sorting and collecting as well as transportation and distribution process of the virgin material are considered to change the results.

## References

1. Schmitt, P., et al.: Additive Manufacturing research landscape: A literature review. In: Proceedings of the Design Society ICED21. Gotheburg, Sweden (2021)
2. Tofail, S.A.M., et al.: Additive manufacturing: scientific and technological challenges, market uptake and opportunities. *Mater. Today* **21**(1), 22–37 (2018)
3. Gebler, M., et al.: A global sustainability perspective on 3D printing technologies. *Energy Policy* **74**, 158–167 (2014)
4. Diaz, N., et al.: Machine tool design and operation strategies for Green Manufacturing. In: Proceedings of 4<sup>th</sup> CIRP International Conference on High Performance Cutting (2010)
5. Kohtala, C.: Addressing sustainability in research on distributed production: an integrated literature review. *J. Clean. Prod.* **106**, 654–668 (2015)
6. Plastics Europe: Plastics—the Facts 2021; <https://plasticseurope.org/wp-content/uploads/2021/12/Plastics-the-Facts-2021-web-final.pdf> (2021)
7. European Parliament, [https://www.europarl.europa.eu/resources/library/images/20210727PHT09210/20210727PHT09210\\_original.jpg](https://www.europarl.europa.eu/resources/library/images/20210727PHT09210/20210727PHT09210_original.jpg) last accessed 2022/05/09
8. Wang, M., et al.: A scientometric review of resource recycling industry. *International Journal of Environmental Research and Public Health* **16**(23) (2019)
9. Kazemi, M., et al.: State of the art in recycling waste thermoplastics and thermosets and the applications in construction. (2021)
10. Hopewell, J., et al.: Plastics recycling: challenges and opportunities. *Philosophical Transactions of the Royal Society B: Biological Sciences* **364**(1526) (2009)
11. Lanzotti, A., et al.: A comparison between mechanical properties of specimens 3D printed with virgin and recycled PLA. In: Proceedings of 12th Conference on Intelligent Computation in Manufacturing Engineering (CIRP12). Gulf of Naples, Italy (2018)
12. Tanney, D., et al.: Investigating material degradation through the recycling of PLA in additively manufactured parts. In: Proceedings of the 28<sup>th</sup> Annual International Solid Freeform Fabrication Symposium (SFF2017). Austin, USA (2017)
13. Spoerk, M., et al.: Mechanical recyclability of Polypropylene composites produced by material extrusion-based Additive Manufacturing. *Polymers* **11**(8), 1318 (2019)
14. Vidakis, N., et al.: Sustainable Additive Manufacturing: Mechanical response of Polypropylene over multiple recycling processes. *Sustainability* **13**(1), 159 (2020)
15. Huang, S.H., et al.: Additive Manufacturing and its societal impact: a literature review. *The International Journal of Advanced Manufacturing Technology* **67**, 1191–1203 (2013)
16. Garcia, F.L., Moris, V.A.S.: Environmental performance of additive manufacturing process – an overview. *Rapid Prototyping Journal* **24**(7), 1355–1177 (2018)
17. ISO 14040: Environmental management – Life cycle assessment – Principles and framework (ISO 14040:2006 + Amd 1:2020)
18. Curran, M.A.: Life Cycle Assessment: a review of the methodology and its application to sustainability. *Curr. Opin. Chem. Eng.* **2**(3), 273–277 (2013)

19. Saade, M.R.M. et al.: How has LCA been applied to 3D printing? A systematic literature review and recommendations for future studies. *Journal of Cleaner Production* (244) (2020)
20. Ribeiro, I., Matos, F., et al.: Good Framework for Life Cycle sustainability assessment of Additive Manufacturing. *Sustainability* **12**(3), 929 (2020)
21. Baumers, M., et al.: Transparency Built-in. Energy consumption and cost estimation for Additive Manufacturing. *Journal of Industrial Ecology* 17(3):418–431 (2012)
22. Bours, J., et al.: Addressing hazardous implications of Additive Manufacturing: Complementing Life Cycle Assessment with a framework for evaluating direct human health and environmental impacts. *Journal of Industrial Ecology* 21(1) (2017)
23. Böckin, D., Tilman, A.-M.: Environmental assessment of additive manufacturing in the automotive industry. *J. Clean. Prod.* **226**, 977–987 (2019)
24. Faludi, J.: Comparing environmental impacts of Additive Manufacturing vs. traditional machining via Life-Cycle Assessment. *Rapid Prototyping J.* **21**(1), 14–33 (2015)
25. ASTM F1980-21: Standard Guide for Accelerated Aging of Sterile Barrier Systems and Medical Devices; (ASTM F1980-21:2021)
26. Bare, J.C., Hofstetter, P., Pennington, D.W. et al.: Midpoints versus endpoints: the sacrifices and benefits. *Int. J. LCA* **5**, 319–326 (2000). <https://doi.org/10.1007/BF02978665>
27. Cerdas, F., et al.: Life cycle assessment of 3D printed products in a distributed manufacturing system: LCA-distributed manufacturing system. *J. Ind. Ecol.* **21**(1), 80–93 (2017)
28. Hauschild, M.Z., et al.: *Life Cycle Assessment. Theory and Practice.* Springer Nature, Cham, Switzerland (2017)

**Open Access** This chapter is licensed under the terms of the Creative Commons Attribution 4.0 International License (<http://creativecommons.org/licenses/by/4.0/>), which permits use, sharing, adaptation, distribution and reproduction in any medium or format, as long as you give appropriate credit to the original author(s) and the source, provide a link to the Creative Commons license and indicate if changes were made.

The images or other third party material in this chapter are included in the chapter's Creative Commons license, unless indicated otherwise in a credit line to the material. If material is not included in the chapter's Creative Commons license and your intended use is not permitted by statutory regulation or exceeds the permitted use, you will need to obtain permission directly from the copyright holder.





# Screening Life Cycle Assessment of Thermoacoustic Panels from Agricultural Byproducts

Rodrigo Salvador<sup>1</sup> (✉) , Gabriela Aparecida Chapiieski<sup>2</sup>, Leandro Inagaki Oshiro<sup>2,3</sup>,  
Eduardo Bittencourt Sydney<sup>2,3</sup> , and Antonio Carlos de Francisco<sup>2,3,4</sup>

<sup>1</sup> Department of Engineering Technology and Didactics, Technical University of Denmark (DTU), Lautrupvang 15, Building Ballerup/Room E2.12, 2750 Ballerup, Denmark  
rodsa@dtu.dk

<sup>2</sup> Universidade Tecnológica Federal Do Paraná (UTFPR), Ponta Grossa, Brazil

<sup>3</sup> Fungi Biotecnologia (Mush), Ponta Grossa, Brazil

<sup>4</sup> Sustainable Production Systems Laboratory (LESP), Ponta Grossa, Brazil

**Abstract.** The objective of this study was to identify the main environmental impacts of thermoacoustic panels manufactured from agricultural byproducts and thereafter propose measures to improve the environmental performance of this product system. The life cycle assessment (LCA) technique was used to account for the environmental impacts in 10 impact categories. The environmental hotspots were the consumption of electricity at the manufacturing stage, and the use of wheat bran as main input. To improve the environmental performance of the system it was suggested the use of different feedstocks throughout the year, thus accounting for seasonality of agricultural byproducts. Another suggestion was to acquire more energy-efficient equipment, on their own or share the equipment with a partner, or acquire a specific energy mix from the local energy carrier or a third party.

**Keywords:** LCA · Circular Economy · Circular Bioeconomy · Sustainable Manufacturing · Waste Valorization

## 1 Introduction

The increasing consumption of resources and generation of waste [1] have led society and companies to realize the need for a transition to the use of more renewable resources and more sustainable production systems. In that regard, products that are based on biomass and bioresources have shown to be a promising alternative [2], thus fomenting a circular bioeconomy [3]. The use of byproducts and wastes as substitutes of virgin material for the manufacturing of different products has been an alternative for boards and panels in the civil construction and decoration industries [4]. These products have been used with intents such as thermal [5] and acoustic insulation [4] and for decoration. Although they might have lower environmental impacts for being made from wastes, thus materials that might have been thrown away otherwise, these products still cause environmental

impacts. It is imperative that manufacturers get to know the environmental impacts of their products and try to make their product systems as least impacting as possible, as they also play a role in knowing and advising the kinds of impacts their products might cause. In that regard, one widely known technique used to guide environmental improvement is the Life Cycle Assessment (LCA). LCA is a technique that allows determining the potential environmental impacts of products (either goods or services/experiences) and the results of an LCA support an informed decision-making [6, 7].

In the existing literature it can be found studies assessing the environmental profiles of thermo-acoustic panels which main input is recycled material, such as from wastepaper and textile fibers [8] (1kg CO<sub>2</sub>-eq/kg of panel), recycled paper and other scrap materials (e.g., as wool and nonwoven polyester fabric) [4] (21.8 kg CO<sub>2</sub>-eq/m<sup>2</sup>), also bio-based materials, such as sheep-wool and hemp [9], and hemp alone [10] (−4.28 kg CO<sub>2</sub>-eq/m<sup>2</sup>). However, even less is found on the environmental performance of thermoacoustic panels based on bio-based waste, such as the study by Ricciardi et al. [5], assessing the thermal performance and climate change impacts of thermal performance of panels from recycled waste (cork scraps, rice husk, coffee chaff, and end-life granulated tires) (analysis of various compositions, e.g., 58% of Cork, 21% of Rice Husk and 21% of Coffee Chaff: 2.2 kg CO<sub>2</sub>-eq/m<sup>2</sup>).

Therefore, building on the need of a more comprehensive knowledge of the environmental impacts of thermos-acoustic panels from bio-based waste, this study aims to identify the main environmental impacts of thermoacoustic panels manufactured from agricultural byproducts and thereafter propose measures to improve the environmental performance of the product system. To that end, we use the LCA technique and assess the environmental impacts of the product system considering 10 impact categories: climate change, abiotic depletion, eutrophication, ozone layer depletion, acidification, freshwater ecotoxicity, human toxicity, marine ecotoxicity, terrestrial ecotoxicity, and photochemical oxidant formation.

## 2 Methods

An LCA study should follow well-established standards, determined by ISO 14040 [6] and ISO 14044 [7], and comprises 4 phases: objective and scope definition, life cycle inventory (LCI), life cycle impact assessment (LCIA), and interpretation. How we framed the study within these phases and their implications to the product system analyzed in this study are presented hereafter.

### 2.1 Objective and Scope Definition, and Choice of LCIA Methods and Categories

A screening LCA study was conducted assessing the opportunities for improving the environmental performance of a thermo-acoustic panel that can be used in the decoration and civil construction sectors. A screening, thus simplified, LCA study was conducted because of restrictions regarding data collection and disclosure of results, since the product system assessed in this study is based on a patent-pending technology. The product is made by the growth of fungi using agricultural byproducts as main feedstock. The objective of this LCA study was to determine the environmental impacts of the product



system thermo-acoustic panel, from a cradle-to-gate perspective, i.e., considering from the extraction of raw materials from nature up to the moment the product is ready to leave the manufacturing facilities. A simplified representation of the system boundaries of this study can be seen in Fig. 1.

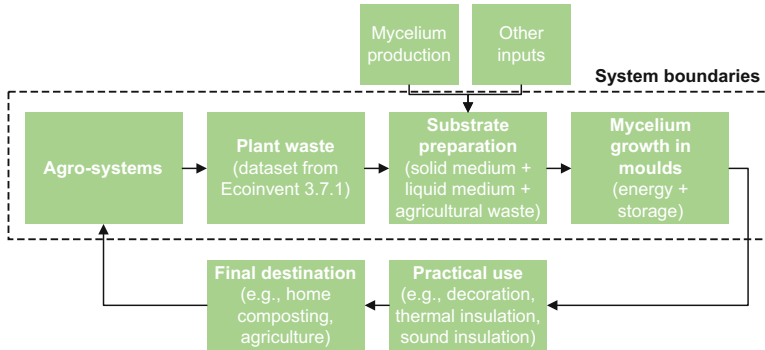


Fig. 1. Simplified system boundaries - Organization Z's thermo-acoustic panels.

The system under which Organization Z works enables a certain degree of circularity, thus they also contribute to a circular economy or circular bioeconomy in this case. It starts with the use of plant waste, especially agricultural byproducts as feedstock to the thermo-acoustic panel.

Within the manufacturing facilities, the “core processes” comprise the production of a liquid medium, a solid medium, and a third process (here called final mix) where the mycelium (which is the fungus) and a few other inputs along with the liquid and solid mediums are added to the main feedstock (which is the agricultural byproduct). Thereafter, the mix is enclosed in molds for the mycelium to grow.

The mycelium grows up to a certain point and then it is inactivated by a thermal treatment. At this point, the final product (thermal-acoustic panel in the desired size and shape, according to the molds used) is obtained. The panel can have a range of practical uses, which is left at the end user’s discretion. At the end-of-life, the panels are compostable, which can be done either at home (e.g., in a garden or as feed for flowers even in small vases) or in any other earth-environment. As they do not make use of any toxic chemicals, it is safe to be used as an input for agro-systems, which wastes can then be once again used as feedstock to produce new panels.

Regarding the functional unit (FU) for this study, as the product can be used with different intents, it was chosen to establish a declared unit (DU) rather than an FU in this study. The DU used in this study was 1kg of thermo-acoustic panel ready for distribution. For that reason, the reference flow chosen was 1kg of thermo-acoustic panel.

Moreover, using as benchmark another study of a similar product, a cork agglomerate panel [11], which has a function like that of the panel analyzed in this study, a few impact categories were chosen to be assessed. The categories used were the same as the benchmark study, since no standardization of LCA studies for this of product are found. Recommendations on the methods to be used to assess each impact category were

obtained from the international EPD® system [12]. The categories and the respective methods used to calculate the impacts are shown in Table 1. Ten impact categories were assessed at midpoint level (i.e., immediate impacts).

**Table 1.** Impact categories and the respective impact assessment methods.

Life Cycle Impact Assessment Method	Impact Category (Midpoint)	Unit
IPCC 2013	Climate Change	kg CO <sub>2</sub> -Eq
CML-IA baseline	Abiotic Depletion	kg Sb-Eq
CML-IA baseline	Eutrophication	kg PO <sub>4</sub> <sup>---</sup> Eq
CML-IA baseline	Ozone Layer Depletion	kg CFC-11-Eq
CML-IA non-baseline	Acidification	kg SO <sub>2</sub> -Eq
ReCiPe Midpoint (H)	Freshwater Ecotoxicity	kg 1,4-DCB-Eq
ReCiPe Midpoint (H)	Human Toxicity	kg 1,4-DCB-Eq
ReCiPe Midpoint (H)	Marine Ecotoxicity	kg 1,4-DCB-Eq
ReCiPe Midpoint (H)	Terrestrial Ecotoxicity	kg 1,4-DCB-Eq
ReCiPe Midpoint (H)	Photochemical Oxidant Formation	kg NMVOC

These midpoint categories provide the immediate impacts of the system. For the interpretation, the hotspots served as starting points for the proposal of improvement measures. Therefore, in line with the company representatives two main improvement measures were proposed (Sect. 4).

## 2.2 Life Cycle Inventory

The LCI was built from specific (primary, measured), selected generic (direct match data from well-established/reowned databases), and proxy (adjusted/close proximity data from well-established/reowned databases, and data based on assumptions) data. Specific data was used in LCIs of the core processes (solid and liquid medium, and final mix), selected generic data and proxy data was used to model the upstream processes. To model upstream processes, a commercial license of Ecoinvent v.3.7.1 was used, together with the database Agribalyse 3.0.1.

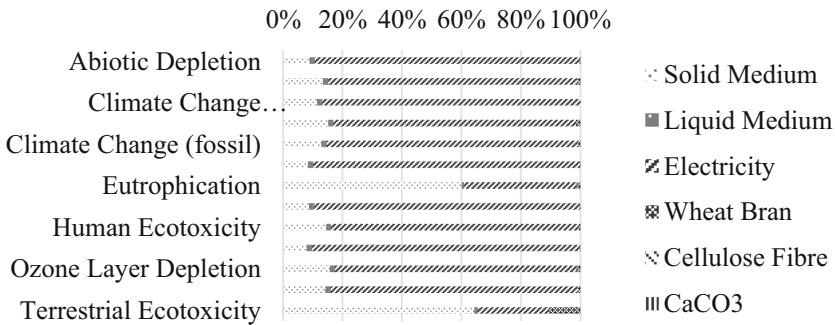
Core processes included the activities necessary to produce the thermo-acoustic panel within the manufacturing gates. Upstream processes included the production of all input materials from “cradle” (i.e., since the moment the resources are extracted from nature) up to the moment the materials/products arrive at the manufacturing facilities. At the manufacturing facilities, inputs are used to produce a liquid medium, a solid medium, and a final process that includes both mediums mentioned and a few other inputs. Further information showing the specific processes and materials included within the system boundaries are not provided for trade secret reasons. Organization Z has a patent-pending technology, hence, the specifics of their processes cannot be disclosed.

### 3 Life Cycle Impacts of Thermoacoustic Panels from Agricultural Byproducts

The environmental performance of the system under study, according to the 10 impact categories assessed, is summarized in Table 2 and Fig. 2.

**Table 2.** Results of LCA of the thermo-acoustic panel.

Method	Impact Category (Midpoint)	Unit	Result (1kg of panel)
CML-IA non-baseline	Acidification	kg SO <sub>2</sub> -Eq	6.88E-03
IPCC 2013	Climate Change (biogenic)	kg CO <sub>2</sub> -Eq	8.88E-01
	Climate Change (fossil)	kg CO <sub>2</sub> -Eq	6.47E-01
	Climate Change (CO <sub>2</sub> uptake)	kg CO <sub>2</sub> -Eq	-7.53E-01
	Climate Change (land use change)	kg CO <sub>2</sub> -Eq	1.58E-01
CML-IA baseline	Abiotic Depletion	kg Sb-Eq	2.17E-05
	Eutrophication	kg PO <sub>4</sub> -Eq	4.01E-03
	Ozone layer depletion	kg CFC-11-Eq	3.43E-08
ReCiPe Midpoint (H)	Freshwater Ecotoxicity	kg 1,4-DCB-Eq	1.47E-01
	Human Toxicity	kg 1,4-DCB-Eq	3.86E-01
	Marine Ecotoxicity	kg 1,4-DCB-Eq	1.25E-01
	Photochemical Oxidant Formation	kg NMVOC	3.09E-03
	Terrestrial Ecotoxicity	kg 1,4-DCB-Eq	3.12E-04



**Fig. 2.** Life cycle impact assessment for thermo-acoustic panel.

The greatest hotspot, contributing the most to the total impacts is electricity. This behavior is noted across almost all impact categories, where it contributed to more than 80% of total impacts. Besides the electricity that is consumed in the final mix, the second hotspot is the solid medium, where once again electricity is the main contributor to total

impacts, followed by the use of wheat bran and waste wood. This behavior can be observed in all impact categories, except for eutrophication and terrestrial ecotoxicity.

For the category eutrophication, the hotspot is the solid medium, where the main contributor is the use of waste wood. Only the second hotspot in this category is the use of electricity in the final mix. For terrestrial ecotoxicity, the solid medium also accounts for the main hotspot, but the main contributor in this case is the use of wheat bran, and once again, only the second hotspot is the use of electricity in the final mix.

## 4 Recommendations and Conclusions of the Study

The objective of this LCA was to define the environmental profile of the impacts of the product system thermo-acoustic panel and suggest measures that could lower the environmental impacts of the system. A few improvement measures can be drawn from those results and suggested to Organization Z, based on the hotspots found during the LCIA phase.

The main hotspots for the product system assessed in this LCA were the use of electricity, and the solid medium. In the solid medium, the components which contributed the most to environmental impacts of the system were the consumption of electricity and the use of wheat bran.

Overall, it is observed that solely reducing the consumption of electricity at the final stage of the production of the panels can contribute to reducing the environmental impacts of the system to a large extent. It is noted that scaling-up the production and using less energy-intensive equipment, or sharing equipment/facilities at this stage, might be able to reduce the net energy consumption and lower the need for energy per product unit.

It is suggested that the company investigate the possibility of replacing the equipment used in the manufacturing facilities aiming at greater energy efficiency, and/or replacing the energy source used to power these pieces of equipment in order to reduce the environmental impacts. Another alternative would be to partner with another organization in order to either share more energy-efficient equipment or establish collaboration to produce their energy from a cleaner source, with lower environmental impacts. Lastly, the company could also buy a specific mix from the energy carrier or a third party. On top of that, it was also suggested the use of different feedstock throughout the year, thus accounting for seasonality of agricultural byproducts, to investigate the environmental impacts (but also impacts on technical quality and market implications) of different byproducts in the production of the thermoacoustic panel.

## References

1. Maina, S., Kachrimanidou, V., Koutinas, A.: A roadmap towards a circular and sustainable bioeconomy through waste valorization. *Curr. Opin. Green Sustain. Chem.* **8**, 18–23 (2017). <https://doi.org/10.1016/j.cogsc.2017.07.007>
2. Salvador, R., Pereira, R.B., Sales, G.F., de Oliveira, V.C.V., Halog, A., De Francisco, A.C.: Current panorama, practice gaps, and recommendations to accelerate the transition to a circular bioeconomy in Latin America and the caribbean. *Circular Econ. Sustain.* **2**(1), 281–312 (2021). <https://doi.org/10.1007/s43615-021-00131-z>

3. Dahiya, S., Kumar, A.N., Sravan, J.S., Chatterjee, S., Sarkar, O., Mohan, S.V.: Food waste biorefinery: sustainable strategy for circular bioeconomy. *Biores. Technol.* **248**, 2–12 (2018). <https://doi.org/10.1016/j.biortech.2017.07.176>
4. Buratti, C., Belloni, E., Lascaro, E., Lopez, G.A., Ricciardi, P.: Sustainable panels with recycled materials for building applications: environmental and acoustic characterization. *Energy Procedia* **101**, 972–979 (2016). <https://doi.org/10.1016/j.egypro.2016.11.123>
5. Ricciardi, P., Belloni, E., Merli, F., Buratti, C.: Sustainable panels made with industrial and agricultural waste: thermal and environmental critical analysis of the experimental results. *Appl. Sci.* **11**(2), 494 (2021). <https://doi.org/10.3390/app11020494>
6. ISO (International Organization for Standardization): Environmental management — Life cycle assessment — Principles and framework. ISO (2006a)
7. ISO (International Organization for Standardization): Environmental management — Life cycle assessment — Requirements and guidelines. ISO (2006b)
8. Ricciardi, P., Belloni, E., Cotana, F.: Innovative panels with recycled materials: thermal and acoustic performance and life cycle assessment. *Appl. Energy* **134**, 150–162 (2014). <https://doi.org/10.1016/j.apenergy.2014.07.112>
9. Pennacchio, R., et al.: Fitness: sheep-wool and hemp sustainable insulation panels. *Energy Procedia* **111**, 287–297 (2017). <https://doi.org/10.1016/j.egypro.2017.03.030>
10. Zampori, L., Dotelli, G., Vernelli, V.: Life cycle assessment of hemp cultivation and use of hemp-based thermal insulator materials in buildings. *Environ. Sci. Technol.* **47**(13), 7413–7420 (2013). <https://doi.org/10.1021/es401326a>
11. Lopes, G.A.: Life cycle assessment of two insulation materials used in civil construction: expanded polystyrene and expanded cork agglomerate [Avaliação do ciclo de vida de dois materiais de isolamento utilizados na construção civil: o poliestireno expandido e o aglomerado de cortiça expandida] (Master's Thesis, Universidade do Porto) (2010)
12. Environdec. <https://www.environdec.com/resources/indicators>. Accessed 14 Mar 2021

**Open Access** This chapter is licensed under the terms of the Creative Commons Attribution 4.0 International License (<http://creativecommons.org/licenses/by/4.0/>), which permits use, sharing, adaptation, distribution and reproduction in any medium or format, as long as you give appropriate credit to the original author(s) and the source, provide a link to the Creative Commons license and indicate if changes were made.

The images or other third party material in this chapter are included in the chapter's Creative Commons license, unless indicated otherwise in a credit line to the material. If material is not included in the chapter's Creative Commons license and your intended use is not permitted by statutory regulation or exceeds the permitted use, you will need to obtain permission directly from the copyright holder.





# A Model Calculation of CO<sub>2</sub> Emissions Saving Potential for Fine Blanking of Inductively Heated Sheet Metal with Comparison of the Product Variants

Ingo Felix Weiser<sup>1</sup>(✉), Tim Herrig<sup>1</sup>, and Thomas Bergs<sup>1,2</sup>

<sup>1</sup> Laboratory for Machine Tools and Production Engineering (WZL) of RWTH Aachen University, Campus-Boulevard 30, 52074 Aachen, Germany

f.weiser@wzl.rwth-aachen.de

<sup>2</sup> Fraunhofer Institute for Production Technology IPT, Steinbachstr. 17, 52074 Aachen, Germany

**Abstract.** The steel processing industry must increasingly question itself with regard to environmental aspects, especially for automobile production. As a consequence of the resulting lightweight construction requirements in the automotive sector, manufacturing processes of industrial relevance must deal with high-strength steels. In case of fine blanking, the process faces its limits already when processing medium-high tensile strength steels because of high tool wear or failure. A promising approach to overcome these process limits is the introduction of heat into the processed metal sheet in order to lower the flow stress of the steel. In order to estimate the sustainability of a fine blanking process with inductively heated sheets, the energy input during heating is investigated in this work. An energy balance is drawn for fine blanking of inductively heated sheets. A further component of the work is the subsequent use phase of the components produced in this way. A consideration of the greenhouse gas emissions savings potential by fine blanking in the German automotive production shows possible future perspectives for manufacturing. It could be found that by substituting standard fine blanking process by inductively heated fine blanking of higher strength steels greenhouse gas emissions can be decreased.

**Keywords:** Fine Blanking · Lightweight Design · Greenhouse gas emissions

## 1 Initial Situation and Motivation

The industrial sector generates the second largest share of emissions in Germany. A large and in recent years increasing part of the industrial share comes from the iron, steel and non-ferrous metals industry. The third largest share of emissions is accounted for by the transport sector, by far the largest part of which coming from road traffic [1]. In this context, the steel processing industry must increasingly question itself with regard to environmental aspects, especially for automobile production. As a consequence of the resulting lightweight construction requirements in the automotive sector, manufacturing processes of industrial relevance must deal with high-strength steels. In case of fine

blanking, which is a central high-productivity manufacturing technology for many parts especially in automobile production, the process faces its limits already when processing medium-high tensile strength steels because of high tool wear or failure. [2] A promising approach to overcome these process limits and to enable fine blanking of high-strength steels is the introduction of heat into the processed metal sheet in order to lower the steel's flow stress. An innovative and economically efficient heating approach is the use of inductive heating. [3] In order to estimate the sustainability of a fine blanking process with inductively heated sheets, the energy input during heating is investigated in this work. As a further consequence of heat introduction beyond lightweight construction gains, a reduction of die roll is to be expected. [4] This implies the possibility to gain further energetic saving opportunities and better material utilization by means of diminution or elimination of downstream manufacturing processes. The focus of the work is on the ecological and energetic consideration of the production process of fine blanked components and the comparison of the conventional fine blanking with fine blanking of inductively heated sheet metal. A further component of the work is the subsequent use phase of the components produced in this way. One of the greatest potentials of the technology of fine blanking of inductively heated materials can be found in the production of highly stressed automotive components. Important for CO<sub>2</sub> emissions per kilometer in the case of internal combustion engines and battery-electric vehicles, the moving mass is particularly important. By using higher-strength steels, automotive components can thus benefit from reduced weight, as their volume can be reduced while retaining virtually the same density. [1] An outlook on the influence of induction heating on the energetic influences of wear at fine blanking tools and product life cycle shows possible future perspectives.

The main feature of fine blanking as a separating manufacturing process is the excellent quality of the cut surface, which allows installation without further finishing steps, such as deburring. As a result, it is used primarily in the production of components with high functional integrity. In particular, the production of functional and safety components in the household appliance industry and in the textile, automotive, medical and electrical sectors, but also in the aerospace or precision engineering industries, is realized using the manufacturing technology of fine blanking. [5].

Previous work has shown that an increase in process temperature and the resulting reduction in the required cutting force offers new possibilities for the economic fine blanking of higher-strength steels, such as S700MC, as these cannot currently be fine blanked in a process-safe manner. The technology considered in this work represents the coupling of conventional fine blanking with sheet heating by means of electromagnetic induction.

## 2 Automotive Component Manufacturing Phase

In order to assess the process energy difference between fine blanking with and without heating of the metal sheet, the forces required to produce exemplary fine blanked automotive components were calculated. The forces without heating and the forces with heating were calculated for the case hardening steel 16 MnCr5 [material number 1.7131,  $R_m = 605$  MPa], for the microalloyed fine-grain steel S700MC [material number 1.8974,

$R_m = 850$  MPa] and for the complex phase steel HDT760C [material number 1.0998,  $R_m = 760$  MPa] and for two different components (a brake carrier plate with a sheet thickness of  $s = 5.5$  mm and a safety belt latch with a sheet thickness of  $s = 2.5$  mm). The steels have been chosen in order to demonstrate increasing lightweight construction potential. The choice of these parts was made because both are usually fine blanked parts which are highly safety relevant and present in every automobile regardless of the drive. Both components are depicted in Fig. 1.



**Fig. 1.** Brake carrier plate and safety belt latch, symbol images. Source: feintool.com

The essential force for the fineblanking process is the cutting force  $F_C$  which was determined using the formula

$$F_C = l_C \cdot R_m \cdot s \cdot c \quad (1)$$

in which  $l_C$  is the length of the cutting line,  $R_m$  is the yield strength of the material,  $s$  is the sheet thickness and  $c$  is a factor describing, in combination with  $R_m$ , the cutting resistance and lies around  $c \approx 0.9$  [5]. The length of the cutting line was determined to be  $l_C = 462.2$  mm for the brake carrier pad and  $l_C = 419.8$  mm for the safety belt latch. The thusly determined cutting forces are given in Table 1.

**Table 1.** Cutting Forces for different steels and parts

Material	Brake Carrier Plate	Safety Belt Latch
16MnCr5	1,384.09 kN	571.44 kN
S700MC	1,944.59 kN	802.84 kN
HDT760C	1,738.69 kN	717.84 kN

The process forces in fine blanking of steel can be reduced by heating the metal sheet [4]. To compare the force values with the force values after inductive heating of the sheet, a temperature factor was used to adjust the yield strength of the materials. The yield strength after heating is calculated using the formula

$$R_{m,T} = R_m \cdot \left(1 - K_T \cdot 10^{-3} \cdot (T - 100)\right) \quad (2)$$



using a factor  $K_T = 1.2$  for S700MC and  $K_T = 1.7$  for 16MnCr5 and HDT760C. The factor  $K_T$  is material dependent and calculated differently for different types of steel, so that steels of similar microstructure show the same values according to RENNERT [6]. The cutting forces resulting from this temperature correction are given in Table 2.

**Table 2.** Cutting Forces for different steels and parts dependent on metal sheet temperature

	With heating		Difference	
Material	Brake Carrier Plate	Safety Belt Latch	Brake Carrier Plate	Safety Belt Latch
16MnCr5	442.91 kN	182.86 kN	941.18 kN	388.58 kN
S700MC	777.84 kN	321.14 kN	1,166.75 kN	481.7 kN
HDT760C	556.37 kN	229.71 kN	1,182.75 kN	488.13 kN

In order to draw a conclusion on the energy balance, the mechanical energy and the thermal energy used by both processes were then calculated. The amount of heat  $Q$  can be calculated as follows:

$$Q = \rho \cdot A \cdot s \cdot c \cdot \Delta T \tag{3}$$

in which  $\rho$  is the density,  $A$  the surface area and  $s$  the sheet thickness of the part,  $c$  is the specific heat capacity and  $\Delta T$  the temperature difference obtained when heating. The cutting work can be calculated with the following formula:

$$W_C = F_C \cdot h_C \cdot k \tag{4}$$

in which  $F_C$  is calculated using formula (1) and  $h_C$  as the cutting height and  $k$  as a correction factor for increasing and decreasing of the cutting force during the stroke. It is assumed that a heating to not more than 500 °C is sufficient to lower the flow stress of the steels but not so high as to initiate undesired changings in the metal crystal lattice. The dependency of metal sheet temperature and fine blanking process forces have been investigated before for different steels [4]. The results of the calculations are given in Table 3.

**Table 3.** Cutting Forces for different steels and parts dependent on metal sheet temperature

Material	Amount of heat inserted to the process $Q/J$		Saved cutting work due to reduced flow stress after heating $W_C/J$	
	Brake Carrier Plate	Safety Belt Latch	Brake Carrier Plate	Safety Belt Latch
16MnCr5	48,867.12 (100%)	9,791.63 (100%)	1,552.95 (100%)	291.44 (100%)
S700MC	52,760.16 (108%)	10,574.11 (108%)	1,925.14 (124%)	361.28 (124%)
HDT760C	57,577.39 (118%)	11,539.57 (118%)	1,950.81 (126%)	366.1 (126%)

It can be seen in Table 3 that the energy required to heat the workpiece is significantly higher than the energy reduced by heating during actual cutting. A break-even point does not exist, as it is always necessary to put more energy into the process by heating than to gain by to flow stress reduction due to inevitable thermal losses. As one Joule accounts for  $1 \cdot 10^{-6}$  kWh, and the production of this amount of 1 kWh of electrical energy emits 420 g CO<sub>2</sub>/kWh [7], each Joule of electrical energy stands for a CO<sub>2</sub> emission of 420 μg. Thus, a brake carrier plate manufactured of S700MC steel with heating would mean an extra CO<sub>2</sub> emission of 21.35 g in comparison to 16MnCr5 without heating and a safety belt latch would mean an extra CO<sub>2</sub> emission of 4.29 g. This means that the advantage of induction heating in fine blanking is not to reduce the cutting forces and thus save energy, but rather to extend the possibilities of fine blanking to higher strength steels so that qualities can be achieved in these steels that would not be possible at all without the heating. The higher-strength steels make it possible to produce thinner components that weigh less than conventional ones. The effects of this weight saving on the energy throughput in the use phase and the associated impact on the environment are analyzed in the following section.

### 3 Use Phase of Automotive Components

In order to assess the use phase of fine blanked components in automobiles, the lightweight construction ratios according to FRIEDRICH [8] were calculated according to the following relation:

$$V_{\text{stat,Material2/Material1}} = \frac{K_{\text{stat,Material2}}}{K_{\text{stat,Material1}}} \begin{cases} < 1 : \text{mass reduction} \\ = 1 : \text{mass unchanged} \\ > 1 : \text{mass increase} \end{cases} \quad (5)$$

In which  $K_{\text{stat}}$  is the static strength indicator [ $\text{g} \cdot \text{mm}^2 / (\text{cm}^3 \cdot \text{N})$ ] for a given material. This procedure allows to compare the physical properties of different materials and to draw conclusions about their according lightweight design potential.  $K_{\text{stat}}$  can be determined as

$$K_{\text{stat}} = \frac{\rho}{R_m} \sim m \quad (6)$$

The static strength indicator was inserted into formula (5) in order to compare the higher strength steels S700MC and HDT760C with 16MnCr5 via their respective lightweight construction ratio  $V_{\text{stat}}$ , which amounts to  $V_{\text{stat}} = 0.72$  for S700MC and to  $V_{\text{stat}} = 0.81$  for HDT760C.

A weight reduction by substituting the reference material is possible if the lightweight construction ratio is less than 1. This is the case for the load case of the static strength (tension/compression)  $V_{\text{stat}}$ . As the lightweight construction ratio  $V_{\text{stat}}$  is directly proportional to the component mass  $m$ , it is deduced that an initial estimate for the expected mass of the component with the new material can be determined from the light-weight ratio:

$$V_{\text{Ft,Material2/Material1}} \approx \frac{m_{\text{Material2}}}{m_{\text{Material1}}} \quad (7)$$

Thus, the expected weight of a component made of S700MC or HDT760C is approx.  $m_{S700MC} = 72.0\% \cdot m_{16MnCr5}$  or  $m_{HDT760C} = 80.5\% \cdot m_{16MnCr5}$ . This corresponds to a relative weight reduction of  $-28.0\%$  for components made of S700MC steel and  $-9.5\%$  for components made of HDT760C steel, which can be seen in Fig. 2.

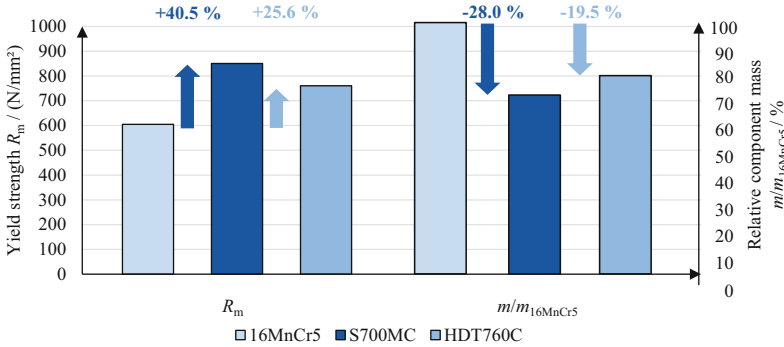


Fig. 2. Comparison of yield strengths and results of the weight reduction analysis

Furthermore, it can be stated that an increase in the strength of a component by means of substitution with another material does not completely result in a reduction of the component weight. The relative mass ratios calculated in this section are lower than the relative ratios of strength values. Nevertheless, Fig. 2 shows a significant potential of decreasing a component’s mass if produced of higher strength steel.

These findings were used to make a rough calculation to determine the specific weight that can be saved if all fine blanked parts in a passenger car are made from higher-strength materials. It is assumed that the starting material of these components is the case hardening steel 16MnCr5 and the substitute material is the fine-grained steel S700MC or the complex-phase steel HDT760C. Subsequently, the ecological effects of this measure will be discussed, focusing in particular on the CO<sub>2</sub> impact.

In any passenger car are up to 200 components which are produced by fine blanking. Since these parts have geometries and masses that vary greatly in some cases due to their different requirements and tasks, the total mass of all fine blanked parts is estimated below. Within the scope of this work, two components were determined which represent the respective upper and lower end of the component individual masses. The weight of each of the two components was determined to be  $m = 0.060\text{kg}$  for the safety belt latch and  $m = 0.230\text{kg}$  for the brake carrier plate.

This gives a range for the total weight of all fine blanked parts in an assumed passenger car of  $m_{ges,FB,16MnCr5} = 200 \cdot 0.060 \dots 0.230\text{kg} = 12 \dots 46\text{kg}$ . Based on the previous results, the total weight can be reduced to  $m_{ges,FB,S700MC} = 72.002\% \cdot m_{ges,FB,16MnCr5} = 8.640 \dots 33.121\text{kg}$  and  $m_{ges,FB,HDT760C} = 80.523\% \cdot m_{ges,FB,16MnCr5} = 9.663 \dots 37.041\text{kg}$ , respectively, if the material 16MnCr5 is replaced by the higher-strength materials S700MC and HDT760C. In other words, the weight is reduced by  $\Delta m_{S700MC} = 3.36 \dots 12.879\text{kg}$  or  $\Delta m_{HDT760C} = 2.337 \dots 8.959\text{kg}$ .

According to data of the German Federal Motor Transport Authority (*Kraftfahrt-Bundesamt*, KBA), the average unladen weight of a newly registered passenger car in

Germany is  $m_{\text{ges}} = 1551.7\text{kg}$  [9]. Thus, the weight reduction related to the unladen weight when 16MnCr5 accounts to  $(\Delta m_{\text{S700MC}})/m_{\text{ges}} = 0.217\dots 0.83\%$  if substituted by S700MC and to  $(\Delta m_{\text{HDT760C}})/m_{\text{ges}} = 0.151\dots 0.577\%$  if substituted by HDT760C. Assuming that the CO<sub>2</sub> emission of a passenger car correlates directly with the vehicle mass moved, this means in the most optimistic case that the pollutant load from CO<sub>2</sub> decreases by 0.83%. Using a calculation based on data from the German Federal Motor Transport Authority and the percentage calculated above, the amount of CO<sub>2</sub> that can be saved by using of higher-strength materials is determined. In each case, the latest relevant statistics are used as a basis. Accordingly, an average new car has CO<sub>2</sub> emissions of 139.8gCO<sub>2</sub>/km (as of 2020 [10]). With an average lifetime of 9.8 years (as of 2021 [11]) and an average mileage of 13,602 km/year (as of 2019 [12]), a total mass of CO<sub>2</sub> of  $m_{\text{CO}_2, \text{single}} = 1,901.57\text{kgCO}_2$  is emitted into the atmosphere over the lifetime of a passenger car in average. Consequently, by reducing the vehicle weight, a mass of CO<sub>2</sub> of  $\Delta m_{\text{CO}_2, \text{single}} = 0.83\% \cdot m_{\text{CO}_2} = 15.783\text{kgCO}_2$  can be saved. This surpasses the extra CO<sub>2</sub> emission in the manufacturing phase of 4.27kgCO<sub>2</sub> for the assumed total mass by the factor 3.7. In relation to the total number of currently registered passenger cars in Germany (48.2 million in 2021 [13]), the calculated CO<sub>2</sub> masses scale to  $m_{\text{CO}_2, \text{ges}} = 91,275 \cdot 10^6\text{tCO}_2$  or  $\Delta m_{\text{CO}_2, \text{ges}} = 757.584\text{tCO}_2$ .

## 4 Conclusion and Outlook

In the work tackled by this paper, the production phase of two example components from a passenger car was investigated, and the effect of inductive sheet metal heating on the cutting work required compared with the energy required for heat input was calculated. In a further section, key figures for lightweight construction were determined with regard to the use of fine blanked automotive components made from higher-strength steels. This involved calculating how increased material strength affects the achievable weight reduction and the associated reduced CO<sub>2</sub> emissions. In summary, fine blanking with inductive sheet heating does not save any energy in the actual fine blanking process since the required heat input at the sheet temperature under consideration compensates for or even exceeds the difference in cutting work achieved. The advantage of the process lies in the possibility of manufacturing components from higher-strength materials in good quality in order, for example, to save weight or cut pollutant emissions in vehicles. However, the greatest effect should come from the reduction in the amount of steel processed and the saving on heat treatments. Within the scope of the work, several assumptions were made regarding the component volume, density, and strength. Therefore, it is not meant to be an exact calculation, but a quantitative assessment of the environmental impact of the processes under consideration. Future approaches could integrate more aspects of lightweight construction, such as tension, pressure, thrust, buckling, bending stiffness, and precise further the balances of the fine blanking process. However, the biggest impact on CO<sub>2</sub> emissions is not likely to come from a mass reduction in the use phase, but from a reduction in the amount of steel produced, as this is the most emission-intensive step in the process. This should be investigated further.

**Acknowledgements.** The authors would like to thank the German Federal Ministry for Economic Affairs and Climate Action (BMWK) for funding research within the project *Feinschneiden von*

*erwärmtem, höherfestem Stahl* (FEST, FKZ: 03LB3016A) within the Technology Transfer Program Lightweight Construction. Special recognition is due to Mirco Trosin and Daniel Schomisch for their work in the creation of this paper.

## References

1. Research and documentation services of the german bundestag: Sachstandsbericht WD 8-3000-013/18: Nationale bzw. EU-weite Einbeziehung weiterer Sektoren in das Europäische Emissionshandelssystem (2018)
2. Dubelová, L., Dublebá, B., Spišák, E.: Analysis of some aspects of fine blanking process. In: Zeszyty Naukowe Politechniki Rzeszowskiej 288, Mechanika 85, RUTMech, z. **85**(2/13), kwiecień-czerwiec S. 19–127 (2013)
3. Weiser, I.F., Mannens, R., Feuerhack, A., Trauth, D., Bergs, T.: An analytical approach for the determination of the temperature distribution in the cross section of a sheet metal caused by inductive heating. *Procedia Manuf.* **29**, 353–360 (2019)
4. Weiser, I.F.; Mannens, R.; Feuerhack, A.; Bergs, T.: Experimental investigation of process forces and part quality for fine blanking of stainless steel with inductive heating. In: Proceedings of 24th International Conference on Material Forming (2021)
5. Klocke, F.: *Manufacturing Processes 4: Forming*, pp. 429–453. Springer Verlag, Berlin (2013)
6. Rennert, R. (ed.): *Analytical Strength Assessment. FKM-Standard VDMA* (2012)
7. German federal environmental agency (UBA Umweltbundesamt): Entwicklung der spezifischen Treibhausgas-Emissionen des deutschen Strommix in den Jahren 1990 – 2021. *Climate Change* 15/2022
8. Friedrich, H.E. (ed.): *Leichtbau in der Fahrzeugtechnik*. (Reihe: ATZ/MTZ-Fachbuch. 2. Auflage. Springer, Wiesbaden (2017). <https://doi.org/10.1007/978-3-658-12295-9>
9. German federal motor transport authority (KBA Kraftfahrt-Bundesamt): Fahrzeuge - Neuzulassungen von Pkw in den Jahren 2010 bis 2019 nach technischen Merkmalen. [https://www.kba.de/DE/Statistik/Fahrzeuge/Neuzulassungen/Motorisierung/fz\\_n\\_motorisierung\\_archiv/2019/2019\\_n\\_motorisierung\\_pkw\\_zeitreihe\\_techn\\_merkmale.html?nn=2601598](https://www.kba.de/DE/Statistik/Fahrzeuge/Neuzulassungen/Motorisierung/fz_n_motorisierung_archiv/2019/2019_n_motorisierung_pkw_zeitreihe_techn_merkmale.html?nn=2601598) [Status: 29.05.2021]
10. German federal motor transport authority (KBA Kraftfahrt-Bundesamt): Fahrzeuge - Monatliche Neuzulassungen. [https://www.kba.de/DE/Statistik/Fahrzeuge/Neuzulassungen/MonatlicheNeuzulassungen/n\\_monatl\\_neuzulassungen\\_inhalt.html?nn=2601598](https://www.kba.de/DE/Statistik/Fahrzeuge/Neuzulassungen/MonatlicheNeuzulassungen/n_monatl_neuzulassungen_inhalt.html?nn=2601598) [Status: 26.03.2021]
11. German Federal Motor Transport Authority (KBA Kraftfahrt-Bundesamt): Fahrzeuge - Bestand an Kraftfahrzeugen und Kraftfahrzeuganhängern in den Jahren 2012 bis 2021 nach ausgewählten Fahrzeugklassen mit dem Durchschnittsalter der Fahrzeuge in Jahren. URL: [https://www.kba.de/SharedDocs/Downloads/DE/Statistik/Fahrzeuge/FZ15/fz15\\_2021.pdf?\\_\\_blob=publicationFile&v=2](https://www.kba.de/SharedDocs/Downloads/DE/Statistik/Fahrzeuge/FZ15/fz15_2021.pdf?__blob=publicationFile&v=2) [Status: 08.05.2022]
12. German federal motor transport authority KBA: Verkehr in Kilometern - Inländerfahrleistung (VK), Entwicklung der Fahrleistungen nach Fahrzeugarten seit 2015. [https://www.kba.de/DE/Statistik/Kraftverkehr/VerkehrKilometer/vk\\_inlaenderfahrleistung/2020/verkehr\\_in\\_kilometern\\_kurzbericht\\_pdf.pdf?\\_\\_blob=publicationFile&v=5](https://www.kba.de/DE/Statistik/Kraftverkehr/VerkehrKilometer/vk_inlaenderfahrleistung/2020/verkehr_in_kilometern_kurzbericht_pdf.pdf?__blob=publicationFile&v=5) [Status: 08.05.2022]
13. German federal motor transport authority (KBA Kraftfahrt-Bundesamt): Verkehr in Zahlen 2020/2021. 49. Jahrgang. Flensburg: Kraftfahrt-Bundesamt (2020)

**Open Access** This chapter is licensed under the terms of the Creative Commons Attribution 4.0 International License (<http://creativecommons.org/licenses/by/4.0/>), which permits use, sharing, adaptation, distribution and reproduction in any medium or format, as long as you give appropriate credit to the original author(s) and the source, provide a link to the Creative Commons license and indicate if changes were made.

The images or other third party material in this chapter are included in the chapter's Creative Commons license, unless indicated otherwise in a credit line to the material. If material is not included in the chapter's Creative Commons license and your intended use is not permitted by statutory regulation or exceeds the permitted use, you will need to obtain permission directly from the copyright holder.





# Considering LCA in System Architectures of Smart-Circular PSS

Thomas Kruschke<sup>(✉)</sup>, Theresa Riedelsheimer, and Kai Lindow

Fraunhofer Institute Production Systems and Design Technology, Pascalstr. 8-9, 10587 Berlin,  
Germany

{thomas.kruschke,theresa.riedelsheimer,  
kai.lindow}@ipk.fraunhofer.de

**Abstract.** The realization of smart-circular Product-Service Systems has theoretically promising advantages compared to traditional products. Nevertheless, the sustainability improvement, especially for the ecological dimension is not yet satisfactorily proved. In this paper, the authors examined the current state of research within a systematic literature review with a specific focus on the overlap of the topics: Life Cycle Assessment, Model-Based Systems Engineering, Product-Service Systems, and Circular Economy. The aim is to analyze the potential of a proactive quantification of the ecological impact in an early stage during the development of smart-circular PSS – the system architecture definition. As a result of the systematic review, 27 relevant papers were identified and analyzed and the findings are presented in a structured way. The main finding is that the current state of the art in this research field still is in the conceptualization stage. In addition, a proactive approach is rare and circularity is not considered to its fullest. Quantified use cases do not draw the system boundaries Cradle-to-Cradle and not every of the 9R-strategies is considered. Furthermore, the potentials and challenges of the revealed research gap are summarized.

**Keywords:** Circular Economy · Smart Product-Service Systems · Life Cycle Assessment · Model-Based Systems Engineering · System architectures

## 1 Introduction

To enable sustainable product and system development, the impact on the environment needs to be considered early on in a products life. Currently, the economic growth is not yet sufficiently decoupled from the environmentally damaging value creation [1–3]. This raises the continuous need for new solutions to allow for the realization of a Circular Economy (CE). One specific access to a green and digital transformation in industry is the establishment of smart-circular Product-Service Systems (PSS), which are defined by Alcaiyaga et al. as smart PSS that pursue sustainable business models, optimize the use of smart products, and reinforce CE through data-driven capabilities [4]. The increasing complexity of these systems demands cross-domain development and put forth the approach of Model-Based Systems Engineering (MBSE). MBSE can support integrating the life cycle and system thinking in the design of smart-circular PSS

© The Author(s) 2023

H. Kohl et al. (Eds.): GCSM 2022, LNME, pp. 694–702, 2023.

[https://doi.org/10.1007/978-3-031-28839-5\\_78](https://doi.org/10.1007/978-3-031-28839-5_78)

[5] and integrate the standardized Life Cycle Assessment (LCA) to foster sustainability monitoring [6]. During the design of system architectures, an LCA database should be coupled with the system architecture [7, 8]. For the authors contains these Hardware, Software, Service incl. R-Strategies and the related infrastructure.

First, this allows engineers to make proactive decisions by considering the potential future environmental impact directly in the engineering environment of the smart circular PSS in focus. Second, the environmental impact of different variants of domain-specific system architectures of smart-circular PSS, including the various R-strategies based on Potting et al. [9], can be compared. According to Blüher et al. [10] and Halstenberg et al. [5, 11, 12], the LCA quantification and the evidence for the improved sustainability of smart-circular PSS is a major challenge – not only during system architecture. Therefore, this paper focuses on answering the following research question with a systematic literature review (SLR): To what extent can MBSE be used for the early assessment of environmental sustainability of smart-circular PSS?

## 2 Methodology of the Systematic Literature Review

As the proposed concept of an integration of LCA in the system architecture definition phase of smart-circular PSS is not fully researched yet, this paper systematically analyzes the current scientific literature with a SLR [13]. It is focused on MBSE, PSS, CE and LCA. For the SLR, the databases Web of Science and Science Direct were used. Figure 1 shows an overview in a flowchart of the specific steps and results, such as the number of selected papers.

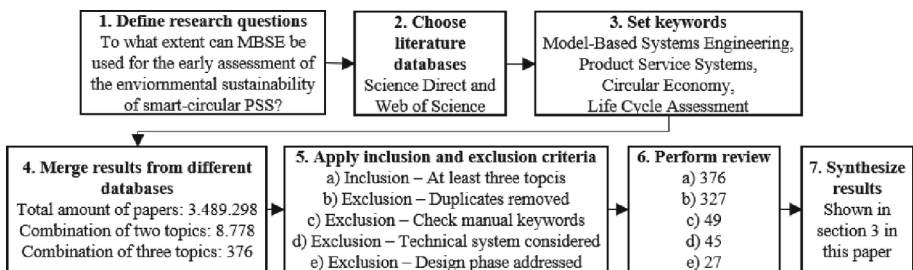


Fig. 1. Flowchart of the applied SLR-Methodology

The 27 relevant publications are analyzed using the following criteria:

- *Technology Readiness Level (TRL)*: Maturity level of the addressed topics oriented to TRL according to the federal ministry for economic affairs and climate action. TRL 1–3 categorized the basic research, 4–6 represent the applied research and 7–9 stands for implementation in the industrial environment [14].
- *Point of time of quantification*: A distinction is made between no, proactive and reactive quantification. Proactive ends after the Design phase and the reactive quantification starting with the production process planning phase e.g. Feedback-to-X or Software/Hardware updates while the usage phase.



- *System boundaries*: For quantification, it is necessary to define the system boundaries. Currently, the LCA method is based on the Cradle-to-Grave approach, which contains raw material mining, production, distribution, usage, and End-of-Life (EOL). Cradle-to-Use excludes the EOL. In addition, the information about the distribution between the value creation processes (VCP) is an impact factor on the LCA-results.
- *R-Strategies*: According to Potting et al. [9] 9R-strategies should be considered, in order of priority: Refuse, Rethink, Reduce, Reuse, Repair, Refurbish, Remanufacture, Repurpose, Recycle and Recover.

### 3 Results

In Table 1, all relevant papers are depicted and evaluated with regards to the defined categories and corresponding characteristics. It shows, that only three papers addressed all four central topics, the remaining papers do not consider MBSE. The collection of papers was finished on February 14<sup>th</sup> 2022.

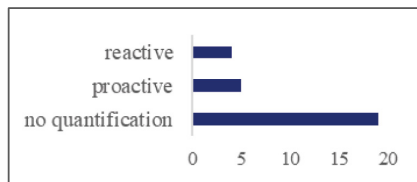
On the basis of this overall examination, a more detailed analysis is executed. In Fig. 3 the maturity level of the addressed topics oriented to TRL from 1–9 is represented. The TRL average of the 27 papers is three. Fifteen papers deal with it in basic research and six starts to transfer into applied research. Only eight papers obtained a TRL 4–5 because these quantified at least one-use cases.

In Fig. 2 the number of quantified and not quantified papers are presented. As mentioned, just eight out of 27 analyzed papers started to quantify use cases. For quantification, a distinction must be made between the five proactive and the four reactive approaches. One Paper from Kjaer et al. [27] described even one proactive and one reactive approach. But none of the eight papers combined the LCA with MBSE.

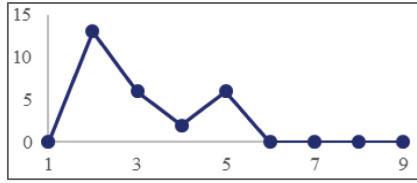
As is seen in Table 1, no one quantified Cradle-to-Cradle and just four papers consider the distances and the mode of transport for the distribution between VCP. Furthermore, the entire steps from raw material mining to the reverse logistics for the realization of the R-strategies are not considered. The main chosen system boundaries are still the Cradle-to-Grave or even just the Cradle-to-Use. Based on Potting et al. [9] the number of addressed 9R-strategies in the 27 selected papers were classified in Fig. 4. None of the papers has seen Refuse as one of the possible R-strategy.

**Table 1.** Overview of the literature body

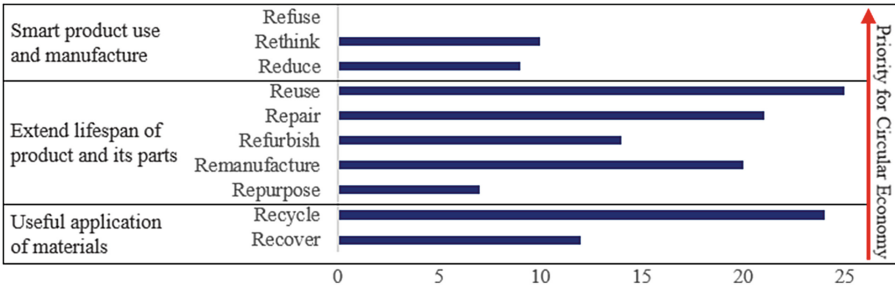
General Information and TRL					Point of time	System boundaries	R-strategies considered																	
Source	Main authors country	Year of publication	CE	PSS	LCA	MBSE	Maturity oriented to TRL	No quantification	Proactive	Reactive	Cradle-to-Use	Cradle-to-Grave	Cradle-to-Cradle	Distribution between VCP	Refuse	Rethink	Reduce	Reuse	Repair	Refurbish	Remanufacture	Repurpose	Recycle	Recover
[12]	GER	2021	x	x	x	x	2	x							x	x	x	x	x	x	x	x	x	x
[15]	SWE	2021	x	x	x		2	x								x	x	x	x	x	x	x	x	x
[16]	RSA	2021	x	x	x		2	x								x	x	x	x	x	x	x	x	x
[17]	GBR	2021	x	x	x		2	x								x	x	x	x	x				x
[18]	GER	2021	x	x	x		2	x								x				x	x			x
[19]	GBR	2021	x	x	x		5		x		x		x			x	x	x						x
[20]	ITA	2021	x	x	x		5		x			x		x			x	x	x	x	x			x
[21]	SWE	2020	x	x	x		3	x								x	x	x	x	x	x	x	x	x
[22]	SWE	2020	x	x	x		5		x		x			x			x	x	x					x
[23]	DEN	2020	x	x	x		2	x								x	x	x	x	x	x	x	x	x
[24]	FRA	2020	x	x	x		3	x								x	x	x	x	x	x	x	x	x
[11]	GER	2019	x	x	x	x	2	x								x	x	x	x	x	x			x
[25]	FRA	2019	x	x	x		2	x								x	x							x
[26]	ESP	2019	x	x	x		5		x		x		x			x	x	x	x	x				x
[27]	DEN	2018	x	x	x		4		x	x		x				x	x	x						
[28]	FIN	2018	x	x	x		3	x								x	x	x	x	x	x			x
[29]	SUI	2018	x	x	x		5		x		x													
[30]	BRA	2018	x	x	x		2	x								x	x	x	x	x				x
[31]	SWE	2018	x	x	x		4		x			x					x			x	x	x	x	x
[32]	BRA	2017	x	x	x		3	x								x	x				x			x
[33]	SWE	2017	x	x	x	x	2	x																
[34]	SUI	2017	x	x	x		2	x								x	x	x	x	x				x
[35]	GBR	2017	x	x	x		3	x								x	x	x	x	x				x
[36]	SLO	2016	x	x	x		2	x									x	x			x			x
[37]	FRA	2015	x	x	x		3	x								x	x	x			x			x
[38]	NED	2014	x	x	x		5		x			x				x	x	x	x	x				x
[39]	FRA	2014	x	x	x		2	x								x	x	x	x	x	x			x
<b>Total</b>			<b>27</b>	<b>27</b>	<b>27</b>	<b>3</b>	<b>Ø 3</b>	<b>19</b>	<b>5</b>	<b>4</b>	<b>2</b>	<b>6</b>	<b>0</b>	<b>4</b>	<b>0</b>	<b>10</b>	<b>9</b>	<b>25</b>	<b>21</b>	<b>14</b>	<b>20</b>	<b>7</b>	<b>24</b>	<b>12</b>



**Fig. 2.** Number of reactive and proactive as well as quantified papers (X = Number of pa-pers)



**Fig. 3.** Maturity level of the addressed topics oriented to TRL ( $X = \text{TRL}$ ) and ( $Y = \text{Number of papers}$ )



**Fig. 4.** Number of addressed R-strategies in the 27 selected papers based on [9] ( $X = \text{Number of papers}$ )

## 4 Discussion

The main results of this paper are the visualizations of the research gap and the most relevant findings of the analyzed criteria. In addition, the identified potentials and challenges of the research gap are summarized and a critical reflection, as well as research proposals, are described in the next sections.

### 4.1 Potentials and Challenges of the Research Gap

The potentials of an LCA in system architectures of smart-circular PSS are promising. Halstenberg et al. described, that engineers get access to sufficient life cycle data, with this the results of LCA can help identify hotspots and trade-offs. The MBSE methodologies can be a successful indicator for the development of smart-circular PSS [12]. Furthermore, is often explained that an integrated tool with an automated connection to ecological databases should be implemented in a common working environment for engineers [11, 12, 23, 29, 33, 34].

Kjaer et al. clarified the importance of a pre quantification with scenario analyzes and sensitivity checks as well as a post quantification to determine the actual behavior of the system and check potential misalignments between expectations and reality [27]. Dokter et al. noted in comprehensive expert interviews that Digital Twin and Digital Product Pass are enable for the circular economy [15]. Scheepens et al. examined the relevance of an eco-friendly product to implement a sustainable business model [38]. Hauschild et al. presented a target-driven life cycle engineering method for reaching

absolute sustainability, which should support product designers to stay within the planetary boundaries during the development phase [23]. Further potentials are the early consideration of implementation of R-strategies in the design phase of products [5, 24, 26, 31, 35] and consideration to implement PSS [29, 31, 33].

In addition to the potentials, there are also challenges for the achievement of the proposed solution. Watkins et al. describe, that a product designer needs additional skills for the development of sustainable products compared to traditional products. They have to be able to understand the sustainability and circular economy issues as well as require critical system thinking and PLC thinking [17]. Böckin et al. outlined that the R-frameworks are idealized descriptions without accounting for real-world conditions like combinations of measures, insufficiently exploited lifetimes, low collection rates, and losses in remanufacturing repair, and recycling [21]. Carlson et al. showed that there could be conflicting objectives between reducing costs and environmental impact, especially for Systems of Systems and the R-strategies are not yet considered for the assessment of LCA [22]. Scheepens et al. added the challenges of the identification of suitable use cases and the attention of regional conditions for the location of product operation [38].

However, further challenges to the development of smart-circular PSS are the product-specific definition of system boundaries [22, 37, 38], the definition of the function unit [27, 37], calculation and reduction of the rebound effects [23, 27], the consideration of various ecological parameters [12, 27], cross-company collaboration across the entire VCP [15, 35], avoidance of burden-shifting [11, 34] as well as the unpredictable behavior of the customer/user for the willingness to collaborate [15, 35, 37].

## 5 Conclusion and Outlook

The results of the SLR show, that the current state of research overall has a low TRL level, especially with regard to LCA as part of system architectures and the combination with MBSE. Next SLR should focus on the combination of two topics in this research field, with the aim to analyze more specific e.g. MBSE and LCA. So, the research question above still stands open. More effort is necessary, so that the development with MBSE and LCA can be a proactive approach, to facilitate environmental impacts can be reduced early on. Further research topics are the integration of lifecycle data, e.g. from Digital Twins, the methodical integration of MBSE and LCA as well as the integration of other key performance indicators in the context of circular economy. Additionally the state of industry needs to be examined and the industrial demands collected to develop a user centered and application specific solution. Only then the industry will be able to develop and operate smart-circular PSS which has a significant lower environmental impact than traditional products.

## References

1. Meadows, D., Randers, J., Meadows, D.: Limits to Growth: The 30-year Update, Chelsea Green Publishing, Chelsea (2004)
2. Circularity Gap Reporting Initiative, Circularity gap report 2021, (2021)

3. Hainsch, K., et al.: Make the European Green Deal real: Combining Climate Neutrality and Economic Recovery, Politikberatung kompakt, DIW Berlin (2020)
4. Alcayaga, A., Wiener, M., Hansen, E.G.: Towards a framework of smart-circular systems: an integrative literature review. *J. Clean. Prod.* **221**, 622–634 (2019)
5. Halstenberg, F.A.: Methodik zur modellbasierten Systemarchitekturdefinition von Smart-circular product-service systems (2022)
6. ISO, 2006, “ISO 14040:2006: Environmental management — Life cycle assessment — Principles and framework, <https://www.iso.org/standard/37456.html>
7. Eigner, M., Dickopf, T., Apostolov, H., Schaefer, P., Faißt, K.G., Keßler, A.: System Lifecycle Management: Initial Approach for a Sustainable Product Development Process Based on Methods of Model Based Systems Engineering. In: Fukuda, S., Bernard, A., Gurumoorthy, B., Bouras, A. (eds.) *Product Lifecycle Management for a Global Market. PLM 2014. IFIP Advances in Information and Communication Technology*, vol. 442, pp. 287–300. Springer, Berlin (2014). [https://doi.org/10.1007/978-3-662-45937-9\\_29](https://doi.org/10.1007/978-3-662-45937-9_29)
8. Zafirov, R.: Produktionsmodelle und Simulation (DiFa). In: Eigner, M., Roubanov, D., Zafirov, R. (eds.) *Modellbasierte Virtuelle Produktentwicklung*, pp. 197–226. Springer, Heidelberg (2014). [https://doi.org/10.1007/978-3-662-43816-9\\_10](https://doi.org/10.1007/978-3-662-43816-9_10)
9. Potting, J., Hekkert, M.P., Worrell, E., Hanemaaijer A.: *Circular Economy: Measuring Innovation in the Product Chain*, PBL Publishers (2017)
10. Blüher, T., Riedelsheimer, T., Gogineni, S., Klemichen, A., Stark, R.: Systematic literature review—effects of PSS on sustainability based on use case assessments. *Sustainability* **12**(17), 6989 (2020)
11. Halstenberg, F.A., Lindow, K., Stark, R.: Leveraging circular economy through a methodology for smart service systems engineering. *Sustainability* **11**(13), 3517 (2019)
12. Halstenberg, F., Dönmez, J., Mennenga, M., Herrmann, C., Stark, R.: Knowledge transfer and engineering methods for smart-circular product service systems. *Procedia CIRP* **100**, 379–384 (2021)
13. TU Berlin, Systematic Literature Review (2019). [https://www.dbwm.tu-berlin.de/menue/fuer\\_forschende\\_lehrende/methode\\_systematic\\_literature\\_review/parameter/en/](https://www.dbwm.tu-berlin.de/menue/fuer_forschende_lehrende/methode_systematic_literature_review/parameter/en/)
14. BMWK, 7. Energieforschungsprogramm: Systemische Forschungsförderung orientiert am „Technology Readiness Level (2018). <https://www.energieforschung.de/energieforschungspolitik/energieforschungsprogramm>
15. Dokter, G., Thuvander, L., Rahe, U.: How circular is current design practice? Investigating perspectives across industrial design and architecture in the transition towards a circular economy. *Sustain. Prod. Consumption* **26**, 692–708 (2021)
16. Daniyan, I., Mpofu, K., Ramatsetse, B., Gupta, M.: Review of life cycle models for enhancing machine tools sustainability: lessons, trends and future directions. *Heliyon* **7**(4), e06790 (2021)
17. Watkins, M., Casamayor, J.L., Ramirez, M., Moreno, M., Faludi, J., Pigosso, D.C.A.: Sustainable product design education: current practice. *She Ji: J. Des. Econ. Innov.* **7**(4), 611–637 (2021)
18. Burggräf, P., Wagner, J., Heinbach, B., Wigger, M.: Design of a methodological framework for adaptive remanufacturing-based business models. *Procedia CIRP* **98**, 547–552 (2021)
19. Wang, S., Su, D., Ma, M., Kuang, W.: Sustainable product development and service approach for application in industrial lighting products. *Sustain. Prod. Consumption* **27**, 1808–1821 (2021)
20. Haber, N., Fargnoli, M.: Sustainable product-service systems customization: a case study research in the medical equipment sector. *Sustainability* **13**(12), 6624 (2021)
21. Böckin, D., Willskytt, S., André, H., Tillman, A.-M., Söderman M.L.: How product characteristics can guide measures for resource efficiency—a synthesis of assessment studies (2020)

22. Carlson, A., Sakao, T.: Environmental assessment of consequences from predictive maintenance with artificial intelligence techniques: Importance of the system boundary. *Procedia CIRP* **90**, 171–175 (2020)
23. Hauschild, M.Z., Kara, S., Røpke, I.: Absolute sustainability: challenges to life cycle engineering. *CIRP Ann.* **69**(2), 533–553 (2020)
24. Rio, M., Khannoussi, K., Crebier, J.-C., Lembeye, Y.: Addressing circularity to product designers: application to a multi-cell power electronics converter. *Procedia CIRP* **91**, 134–139 (2020)
25. Allais, R., Gobert, J.: Conceptual framework for spatio-temporal analysis of territorial projects. *Environ. Impact Assess. Rev.* **77**, 93–104 (2019)
26. Lozano-Miralles, J.A., Hermoso-Orzáez, M.J., Gago-Calderon, A., Brito, P.: LCA case study to LED outdoor luminaries as a circular economy solution to local scale. *Sustainability* **12**(1), 190 (2019)
27. Kjaer, L.L., Pigosso, D.C.A., McAloone, T.C., Birkved, M.: Guidelines for evaluating the environmental performance of product/service-systems through life cycle assessment. *J. Clean. Prod.* **190**, 666–678 (2018)
28. Manninen, K., Koskela, S., Antikainen, R., Bocken, N., Dahlbo, H., Aminoff, A.: Do circular economy business models capture intended environmental value propositions? *J. Clean. Prod.* **171**, 413–422 (2018)
29. Fontana, A., Corti, D., Alge, M., Petrucciani, M., Calvo, L., Marangi, L.: Integrating a LCA tool with a design platform towards a sustainable-aware PSS design: application in a FabLAB environment. *IFAC-PapersOnLine* **51**(11), 1125–1130 (2018)
30. de Medeiros, J.F., Lago, N.C., Colling, C., Ribeiro, J.L.D., Marcon, A.: Proposal of a novel reference system for the green product development process (GPDP). *J. Clean. Prod.* **187**, 984–995 (2018)
31. Barletta, I., Despeisse, M., Johansson, B.: The proposal of an environmental break-even point as assessment method of product-service systems for circular economy. *Procedia CIRP* **72**, 720–725 (2018)
32. de Pádua Pieroni, M., Marques, C.A.N., Moraes, R.N., Rozenfeld, H., Ometto, A.R.: PSS design process models: are they sustainability-oriented? *Procedia CIRP* **64**, 67–72 (2017)
33. Jaghbeer, Y., Hallstedt, S.I., Larsson, T., Wall, J.: Exploration of simulation-driven support tools for sustainable product development. *Procedia CIRP* **64**, 271–276 (2017)
34. Dyllick, T., Rost, Z.: Towards true product sustainability. *J. Clean. Prod.* **162**, 346–360 (2017)
35. Bridgens, B., Hobson, K., Lilley, D., Lee, J., Scott, J.L., Wilson, G.T.: Closing the loop on E-waste: a multidisciplinary perspective. *J. Ind. Ecol.* **23**(1), 169–181 (2019)
36. Lukman, R.K., Glavič, P., Carpenter, A., Vrtič, P.: Sustainable consumption and production—research, experience, and development—the Europe we want. *J. Clean. Prod.* **138**, 139–147 (2016)
37. Romain, A., Julie, G., Bertrand, L., Bertrand, G., Dominique, B.: Small household equipment toward sustainability. *Procedia CIRP* **30**, 179–184 (2015)
38. Scheepens, A.E., Vogtländer, J.G., Brezet, J.C.: Two life cycle assessment (LCA) based methods to analyse and design complex (regional) circular economy systems. Making water tourism more sustainable. *J. Clean. Prod.* **114**, 257–268 (2016)
39. Jung, B., Levrat, E.: Advanced maintenance services for promoting sustainability. *Procedia CIRP* **22**, 15–22 (2014)

**Open Access** This chapter is licensed under the terms of the Creative Commons Attribution 4.0 International License (<http://creativecommons.org/licenses/by/4.0/>), which permits use, sharing, adaptation, distribution and reproduction in any medium or format, as long as you give appropriate credit to the original author(s) and the source, provide a link to the Creative Commons license and indicate if changes were made.

The images or other third party material in this chapter are included in the chapter's Creative Commons license, unless indicated otherwise in a credit line to the material. If material is not included in the chapter's Creative Commons license and your intended use is not permitted by statutory regulation or exceeds the permitted use, you will need to obtain permission directly from the copyright holder.





# Dynamic LCA and LCC with ECOFACT

Emilia Ingemarsdotter, Sahil Singhania<sup>(✉)</sup>, and Georgios Pallas

PRé Sustainability, Stationsplein 121, 3818 LE Amersfoort, Netherlands  
Singhania@pre-sustainability.com

**Abstract.** This paper introduces the work on dynamic life cycle assessment (LCA) and life cycle costing (LCC) carried out within the EU Horizon 2020 project ECOFACT. The goal of the ECOFACT project is to develop a digital platform for manufacturing companies to optimize their production systems for energy, costs, resources and life cycle impacts. The platform will include a manufacturing decision-support-system based on dynamic LCA and LCC and it will be demonstrated in four factories that are members of the project consortium. Dynamic and automated LCA and LCC provides opportunities for new insights compared to conventional, static assessments. For example, temporal variations in the environmental impact can be made available on an hourly, daily, monthly and yearly basis. Moreover, once set up, LCA and LCC results can automatically be updated with the latest data, reducing efforts and costs related to data collection and reporting. In this paper, we briefly explain the ECOFACT approach to dynamic LCA and LCC and discuss preliminary learnings as well as future opportunities.

**Keywords:** Life Cycle Assessment · Smart Manufacturing · Life Cycle Costing · Industry 4.0 · Sustainability

## 1 Introduction

Life Cycle Assessment (LCA) is a science-based and standardized method for assessing the environmental impacts of products and services used by companies as well as policy makers (LCANZ 2022; Nygren & Antikainen, 2010). Life Cycle Costing (LCC) is a method to compile all the costs associated with a product throughout its life-cycle (ISO 15686–5:2017). The combination of LCA with LCC can support decision making based on both environmental and economic factors (Stewart et al. 2018).

The increasing focus on sustainability in business and policy drives a strong demand automated and large-scale solutions to LCA. The current practice of doing LCA often relies on static calculations based on average input data from a limited temporal scope (Sohn et al. 2020). The effort of updating the results for another time period can be considerable. Therefore, one way to accommodate the scale-up of LCA is to automate the data collection process. This can reduce the time needed, increase the reliability of the data, and ensure that comparable data is used every time. Moreover, automatic data collection allows for dynamic assessments, i.e. that the results can be updated frequently with new input data. Such a dynamic approach can help identify environmental impact patterns based on short-term variations in input data. Similarly, dynamic input data to



LCC calculations allow for cost impact results that vary over time, including for example fluctuations in material costs.

This paper presents work carried out as part of the EU Horizon 2020 ‘ECO-innovative Energy FACTory Management’ (ECOFACT) project (ECOFACT 2021). The goal of the ECOFACT project is to develop a digital platform for manufacturing companies, which can use it to optimize their production systems in terms of energy, costs, resources, and life cycle impacts. A high-level visualization of the proposed platform is presented in Fig. 1. The project includes four manufacturing companies serving as demonstration cases. The demonstration cases cover the following types of production processes: beer brewing, cookies/biscuits baking, washing machine production, and car painting.

The work presented in this paper relates to work package 4 (WP4), focusing on developing a dynamic LCA/LCC module. The ECOFACT platform allows data from the factories to be sent to the LCA/LCC module. For example, dynamic data can be collected about the energy consumption of factory processes, amounts of incoming materials used in the factory, and amounts of waste sent to waste treatment. The LCA/LCC module can then continuously and automatically generate updated environmental and cost impact results. The scope for the LCA is cradle to gate, i.e. including the production of upstream materials and components as well as the manufacturing process itself. For the LCC, costs borne by the manufacturing company are included (e.g., raw material costs, energy costs maintenance costs, waste management costs). In the LCA, the production of upstream materials and components are generally included using secondary datasets. However, a “supply chain collaboration service” is used in one of the demo cases to demonstrate how dynamic data from a supplier can be transferred and used.

There are examples in previous literature of dynamic LCA and LCC applications based on variable manufacturing data (e.g., Cerdas et al. 2017, Andersson 2013, Rödger et al. 2020). However, most papers are based on simulations rather than real-time monitoring, and to the best of the authors’ knowledge, there are no reports of previous projects in which an automated solution for dynamic LCA is implemented and tested at large-scale, fully-operational manufacturing sites. The goal of this paper is thus to introduce the ECOFACT approach to dynamic LCA and LCC and to extract preliminary learnings from the project so far. In order to present general learnings that are not tied to the use of specific software or service providers, we focus on the key steps of the approach rather than the detailed technical solution.

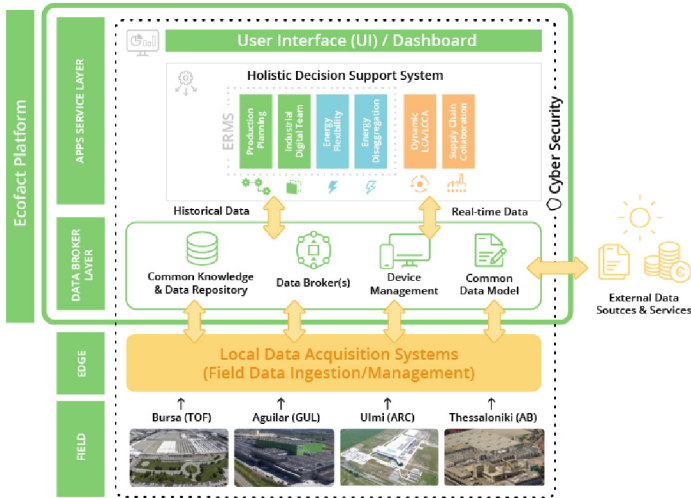


Fig. 1. High-level visualization of the ECOFACT platform and its different components

## 2 The ECOFACT Approach to Dynamic LCA and LCC

The LCA/LCC module is one part of the ECOFACT platform (Fig. 1), which will receive up-to-date data from the factory. The ECOFACT project also demonstrates the integration of dynamic data from suppliers via a supply chain collaboration service. This means that dynamic energy and water data for the production of one component from one supplier is collected and introduced to the ECOFACT platform.

The flowchart in Fig. 2 shows how the dynamic LCA/LCC results are generated from the collected data. The ECOFACT platform integrates the data and sends an Application Programming Interface (API) request to the LCA/LCC module. The model is updated with the new values coming from the field, an LCA/LCC calculation is triggered, and the updated results are sent back to the ECOFACT platform. The platform visualizes the results and provides decision support to the user.

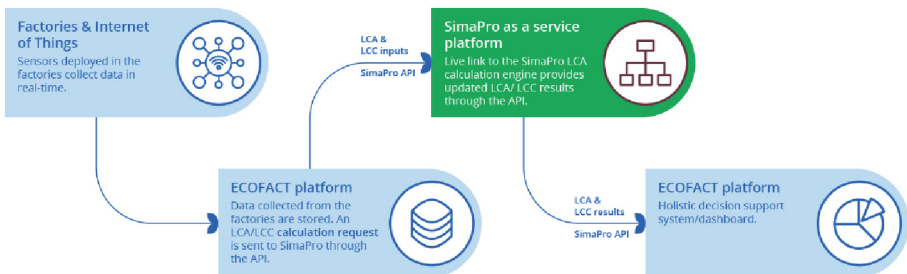
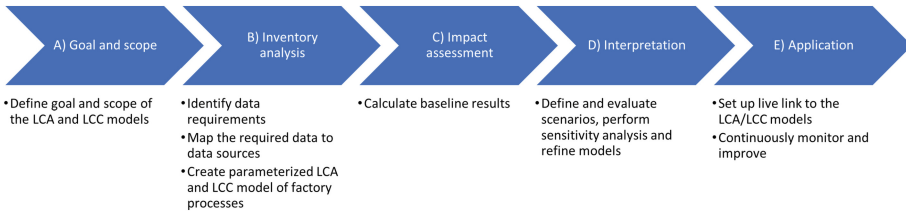


Fig. 2. Flow chart for dynamic LCA and LCC model (Pallas, 2021). Visualization by Catinca Popescu.

In Fig. 3, and in the text below, we detail five key steps in the ECOFACT approach to dynamic LCA and LCC. The steps are elaborated from the four steps described in the ISO standard for LCA (ISO 14040:2006) and which are also applicable in LCC:

A) goal and scope definition, B) inventory analysis, C) impact assessment, and D) interpretation. We argue that a fifth step is relevant to add, namely E) application. This is the step where the learnings from study are put in practice.



**Fig. 3.** Steps of an LCA/LCC detailed in the context of automated, dynamic LCA/LCC based on manufacturing data.

## A. Goal and Scope Definition

- *Define the goal and scope of LCA and LCC models*

This step includes describing the system boundaries and defining the environmental and cost KPIs to be calculated. This step is the same as for a conventional static LCA. In the ECOFACT demonstration cases, the goal for the LCA and LCC models is to continuously monitor the environmental impact and costs of the factory as a whole and in relation to a unit of the produced product (e.g., one washing machine or one hectoliter of beer). The scope of the LCAs is from cradle to gate and the scope of the LCC is costs borne by the manufacturing company. The environmental KPIs to be calculated include a selection of the impact categories from the EF3.0 impact assessment method (Zampori and Pant 2019) as well as total energy consumption and total resource consumption. Cost KPIs include, for example, energy costs, maintenance costs, and waste management costs.

## B. Inventory Analysis

- *Identify data requirements*

Based on the goal and scope, the next step is to list the data requirements for performing the desired analysis. This step is the same as for a conventional static LCA. Important data points include, for example, the bill of materials of the product, energy consumption of different process steps, water use, material inputs, and waste amounts. Identifying the data requirements in dynamic LCA and LCC also includes specifying which data points will be dynamic, i.e. updated continuously, and which can

be considered static. For instance, electricity consumption can be updated continuously while the bill of materials of the supplied components can be static.

- *Map the required data to data sources*

For the dynamic data points, it is necessary to make a detailed map of the data sources from which the data will be collected. The data sources can be sensors, meters, management systems, but also manual input from users. Apart from using data sources from the manufacturing company itself, the ECOFACT project also demonstrates the integration of dynamic data from a supplier. If this mapping step reveals that additional components for automated data collection are desirable, such installations should be detailed and planned.

- *Create parameterized LCA and LCC models of the factory processes*

The next step is to build the model that will use the data. The models need to be parameterized, meaning that inputs are defined as parameters that are updated when new data becomes available. This way, we get a dynamic model that continuously calculates updated impact results. The first version of the model can use input values based on historical data from the factory. In ECOFACT, the models are built in SimaPro Flow (SimaPro-Flow 2022), which is a cloud-based online software. A calculation request with updated parameter values can be sent to the models via the SimaPro API (SimaPro-API 2022).

### **C. Impact assessment**

- *Calculate baseline results*

When a model is in place, a baseline result is obtained based on historical data. The baseline results give initial insights into environmental and cost hotspots. At this stage, the models or data requirements can also be modified. For instance, if a certain process has an insignificant effect on the total results, data from that process might not have to be measured dynamically, thereby reducing unnecessary data transfer and processing.

### **D. Interpretation**

- *Define and evaluate scenarios, perform sensitivity analysis and refine models*

Sensitivity analysis of the results can give important insights into the type of actions that would be effective for the company to pursue. Depending on the user's needs, it is possible to create scenarios to be evaluated. Based on this interpretation step, it might, again, be decided to modify the model or the data requirements.

## E. Application

- *Set up live link to feed data to the LCA/LCC models*

The measurement devices in the factories will continuously monitor the important parameters in the production processes and send the data to the ECOFACT platform in specific time intervals. Via the so called Data Broker, which manages data flows between platform modules, a calculation request is sent to the LCA/LCC models, containing updated parameter values. The LCA/LCC models calculate a new results and send it back to the Data Broker. For this to work, there needs to be a way to exchange data between the Data Broker and the LCA/LCC module. In the ECOFACT project, the models are built in the online software SimaPro Flow (SimaPro 2022). When the Data Broker receives new data from the factory, or at certain pre-defined time intervals, a calculation request is triggered using the custom-built SimaPro API (SimaPro-API 2022).

- *Continuously monitor and improve*

The ECOFACT platform will provide continuously updated environmental impact results to the factories. It will allow them to monitor their environmental footprint and cost impact over time. The insights derived from this can provide opportunities for targeted actions that can optimize the production and costs associated with energy, resource use and life cycle impact.

## 3 Discussion

### 3.1 Dynamic vs. Static LCA/LCC

Traditional static LCA/LCC is useful for identifying environmental and cost impacts, opportunities and trade-offs and it allows for scenario analyses and product comparisons. The life cycle impact is typically assessed as an average impact of a product over a period of time. Automated, dynamic LCA/LCC based on real-time manufacturing data can go beyond what traditional static LCA offers by unlocking new temporal insights. Below we list some examples of such potentially new insights:

- Seasonal variations in performance can be observed. For instance, a factory might have a lower environmental impact during the summer months due to lower heating needs or the use of more renewable energy.
- The effect of changing settings or operational parameters of the production machineries can be observed in the life cycle impact on daily, or even hourly basis.
- If a quality issue results in higher scrap levels for a certain time period, a temporary increase in environmental impact can be observed.
- The effect of maintenance can be observed. For example, the maintenance of a machine might reduce its energy consumption and thereby the environmental impact.

These new insights could be translated into targeted actions to improve the factory's environmental performance, such as:

- Through production planning, it might be possible to shift production to specific days of the week or even specific hours during the day when the impact is low.
- Particularly energy-intensive production processes can be moved to days with favorable weather forecasts to derive maximum potential from renewable energy sources.
- Operational parameters can be adjusted for optimal performance.
- The maintenance frequency could be adjusted for optimal performance.

### 3.2 Future Work

The ECOFACT project will demonstrate the use of dynamic LCA and LCC in four factories. In these demonstration cases, the scope of the LCAs are cradle to gate, which means that we do not include impacts that take place in the life cycle stages after manufacturing. Future projects could include the use phase and the end of life of the products produced in the factory. To include these stages dynamically, data would have to be shared between different actors along the life cycle. As mentioned earlier, the ECOFACT project integrates dynamic data from an upstream supplier of one factory, but this could in theory be extended to include downstream data from the product use or recycling.

Another interesting avenue for future research and innovation is to make the model more dynamic in itself by coupling the LCA software to other systems containing information about, for example, the factory layout or the bill of materials of the products. The model could then be updated automatically if the factory layout or product design changes. Dynamic aspects can also be introduced in impact assessment methods (e.g. Lueddeckens et al. 2020) and even in the scope (Sohn et al. 2020).

Finally, the continuous monitoring of environmental and cost impacts would potentially lead to new (research) questions, opening up the road to new developments and added value to the stakeholders involved. For instance, machine learning models could be applied to the large input data gathered from the factories and their associated LCA/LCC results that will be generated over time. Applying analytics can allow the identification of patterns, parameter correlation with impacts or other insights. Machine learning could be used to predict impacts of specific actions, further optimize product manufacturing, and reduce costs and environmental risks of new product developments.

## 4 Conclusion

The goal of this paper was to introduce the ECOFACT approach to dynamic LCA and LCC and to extract preliminary learnings from the project so far. In order to present general learnings that are not tied to the use of specific software or service providers, we focus on the key steps of the approach rather than the detailed technical solution. We described our approach based on the standardized steps of an LCA/LCC and discussed opportunities and future work. As the ECOFACT project is an ongoing innovation project, the paper presents preliminary findings. Interested readers should refer to the to-be-published ECOFACT project deliverables for more detailed reports on the setup and approach.

**Acknowledgements.** The authors acknowledge all ECOFACT partners' role in the planning, management, and execution of the ECOFACT project.

**Funding.** This project has received funding from the European Union's Horizon 2020 Research and Innovation Programme under Grant Agreement no 958373 (CORDIS [2020](#)).

## References

- Andersson, J.: Life cycle assessment in production flow simulation for production engineers. In: 22nd International Conference on Production Research (2013)
- Cerdas, F., Thiede, S., Juraschek, M., et al.: Shop-floor life cycle assessment. In: The 24th CIRP Conference on Life Cycle Assessment, pp. 393–398. (2017)
- CORDIS. ECO-innovative Energy FACTory Management System based on enhanced LCA and LCCA towards resource-efficient manufacturing. 1 October 2020. <https://cordis.europa.eu/project/id/958373>
- ECOFACT (2021). <https://ecofact-project.eu/>
- LCANZ. business benefits of LCA (2022). <https://lcanz.org.nz/lca-in-practice/business-benefits>
- Lueddeckens, S., Saling, P., Edeltraud G.: Temporal issues in life cycle assessment - a systematic review. *Int. J. Life Cycle Assess.* **25**, 1385–1401 (2020). <https://doi.org/10.1007/s11367-020-01757-1>
- Molina-Murillo, S.A., Smith, T.M.: Exploring the use and impact of LCA-based information in corporate communications. *Int. J. Life Cycle Assess.* **14**, 184–194 (2009)
- Nygren, J., Antikainen, R.: Use of life cycle assessment (LCA) in global companies (2020)
- Pallas, G.. Real-time, large-scale LCA with ECOFACT. <https://pre-sustainability.com/articles/real-time-large-scale-lca-with-ecofact/>. (2021)
- Rodger, J-M., Beier, J., Schonemann, M., et al.: Combining life cycle assessment and manufacturing system simulation evaluating dynamic impacts from renewable energy supply on product-specific environmental footprints. *Int. J. Precision Eng. Manuf.-Green Technol.* **8**, 1007–1026. (2020). <https://doi.org/10.1007/s40684-020-00229-z>
- SimaPro. 2022. SimaPro API, PRe Sustainability. <https://simapro.com/products/api/>
- . 2022. SimaPro Flow, PRe Sustainability. <https://simapro.com/products/simapro-flow/>
- Sohn, J., Kalbar, P., Goldstein, B., Birkved, M.: Defining temporally dynamic life cycle assessment: a review. *Integr. Environ. Assess. Manag.* **16**(3), 314–323 (2020)
- ISO. ISO 15686-5 Buildings and constructed assets (2017)
- ISO. ISO 14040:2006. Environmental management — Life cycle assessment — Principles and framework (2006)
- Stewart, R., Fantke, P., Bjorn, A., et al.: Life cycle assessment in corporate sustainability reporting: global, regional, sectoral, and company-level trends. *Bus. Strateg. Environ.* **27**(8), 1751–1764 (2018)
- Zampori, L., Pant, R.: Suggestions for updating the product environmental footprint (PEF) method. European Commission- JRC Technical Reports (2019)

**Open Access** This chapter is licensed under the terms of the Creative Commons Attribution 4.0 International License (<http://creativecommons.org/licenses/by/4.0/>), which permits use, sharing, adaptation, distribution and reproduction in any medium or format, as long as you give appropriate credit to the original author(s) and the source, provide a link to the Creative Commons license and indicate if changes were made.

The images or other third party material in this chapter are included in the chapter's Creative Commons license, unless indicated otherwise in a credit line to the material. If material is not included in the chapter's Creative Commons license and your intended use is not permitted by statutory regulation or exceeds the permitted use, you will need to obtain permission directly from the copyright holder.







# Sustainability Assessment of Aerospace Manufacturing: An LCA-Based Framework

Yousef Haddad<sup>(✉)</sup>, Sandeep Jagtap, Emanuele Pagone, and Konstantinos Salonitis

Sustainable Manufacturing Systems Centre, School of Aerospace, Transport and Manufacturing,  
Cranfield University, Cranfield MK43 0AL, UK  
yousef.haddad@cranfield.ac.uk

**Abstract.** In this paper, a life cycle assessment (LCA)-based sustainability assessment framework is developed to estimate the environmental impact of production processes. The framework provides a methodical, context-independent, approach to carry out LCA studies. The framework sets guiding principles for products and key performance indicators (KPIs) selection and the associated data requirements in a reconfigurable manner that can be applied to any industrial setting. In order to validate and demonstrate the applicability of the framework, a cradle-to-gate case study pertaining to the manufacturing of a real aerospace metallic structural component is carried out. Results revealed that the complexity of aerospace components makes it difficult to improve the environmental impact from manufacturing operations as most of the impact comes from upstream activities that aerospace manufacturers, typically, have no control over, or access to.

**Keywords:** Sustainability assessment · Life cycle assessment · Aerospace manufacturing

## 1 Introduction

Interest in sustainability has been steadily gaining momentum over the last few decades. Indeed, in addition to the classical cost, time, quality and flexibility, sustainability is increasingly considered the fifth decision-making attribute in manufacturing systems [1]. Most governments have recently legislated laws to achieve Net-Zero emissions before the end of the century. The United Kingdom, for example, has set a goal to realize Net-Zero emissions by the year 2050. Achieving such a goal requires estimating the magnitude of GHG emissions from all sectors with a fair degree of certainty using scientific methods. In order to do so, it is important to measure GHG emissions not only at site levels (e.g., within the boundaries of a factory), but to take a life cycle perspective to understand the underlying emissions throughout a product's entire life cycle, from material extraction, up to disposal or recycling. In addition to GHG emissions, the sole focus of Net-Zero, there are other environmental concerns that merit similar efforts to mitigate. Such concerns include the availability of resources, emission of toxic and hazardous materials and land use, amongst many others. Apart from the environmental

concerns, sustainability consists of two more pillars; social and economic. The intersection of these three pillars constitutes what is known as sustainability. An example of a plan with well-defined goals and a list of actions is portrayed in the United Nation's 17 Sustainable Development Goals, which cover all pillars of sustainability [2].

Life cycle assessment (LCA) is a widely used approach for sustainability assessment. It captures the impact that a product, service, or a process has on the environment [3] (or on the social or economic pillars, when life cycle costing or social LCA are used, respectively) during its entire life cycle (or specified boundaries). Within the aerospace manufacturing sector, which is the focus of this paper, most LCA studies are dedicated to the use phase of an aircraft, sidelining other life cycle phases, due to their (comparatively) significantly lower environmental impact. For example, one of the papers [4] that included the production phase of a commercial aircraft found that 99% of the environmental impact comes from the use phase. It further stated that wings and engine production accounted for 63% of the environmental impact of the corresponding components' production phase. In [5], the authors presented an approach for designing aerospace structural components with additive, instead of subtractive, manufacturing. In [6], the authors conducted an LCA study for the component designed in [5] and proposed a multi-criteria decision-making method to compare the two components (subtractive vs. additive manufacturing). A similar study was also conducted in [7], where the authors proposed the use of carbon fiber reinforced plastics. These two papers, i.e., [6, 7], accounted only for the component manufacturing process of the entire life cycle.

In this paper, an LCA-based sustainability assessment framework is developed to estimate the environmental impact of manufacturing processes. The framework is context-independent and is not confined to the aerospace manufacturing sector. A real case study on a metallic structural component from the UK aerospace manufacturing sector is performed to validate and demonstrate the framework's applicability. The rest of the paper is organised as follows: Sect. 2 presents the sustainability assessment framework. Section 3 presents the case study and discusses the numerical results. Finally, Sect. 4 discusses the concluding remarks.

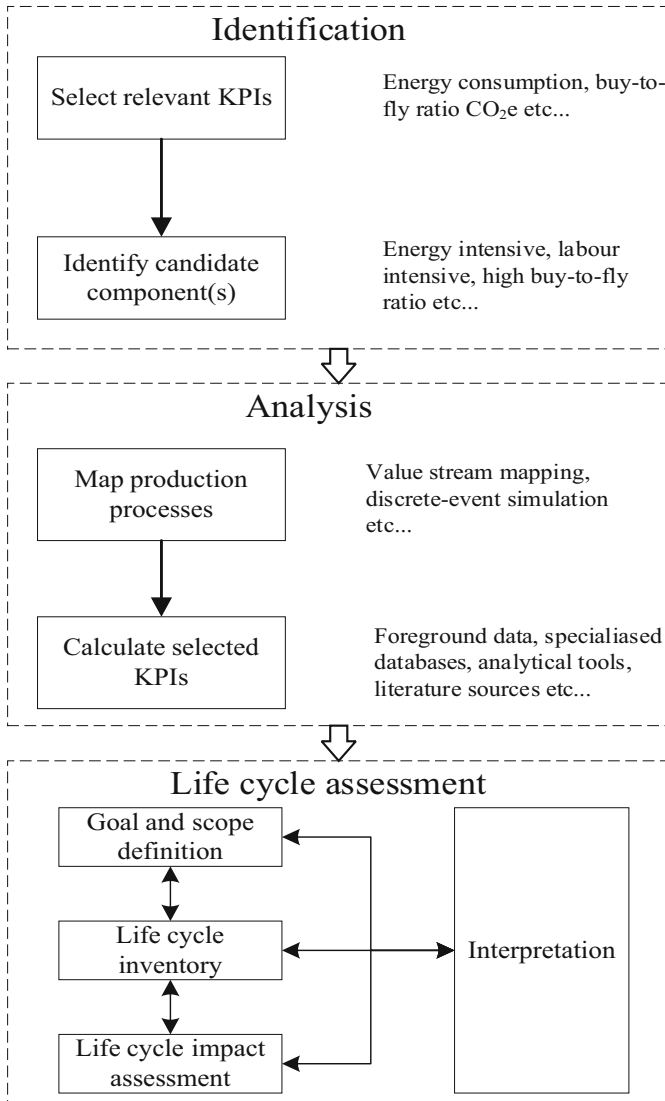
## 2 LCA-Based Sustainability Assessment Framework

The sustainability assessment framework, depicted in Fig. 1 below, applies to a wide array of industrial settings and consists of three stages: identification, analysis, and LCA. In the first (identification) stage, relevant key performance indicators (KPIs) are identified. These KPIs are used in this stage to identify the hotspots that contribute the most to the environmental performance. Such KPIs can be related to waste reduction, energy efficiency, hazardous materials reduction or any other KPI in line with the goal of the industrial setting of framework application. It is worth noting here that these KPIs, identified at the initial stage of the sustainability assessment framework, differ from those determined throughout the LCA, which will be explained later. After identifying the KPIs, the candidate component(s), which are the basis of the LCA study, will be identified. It is important to note that most LCA studies are conducted on a component/product or a service because of the data-intensive nature of such studies. It is therefore difficult

to conduct an LCA study on an entire production system that produces various components/product as this will entail tracing each of these components/products' life cycles from material extraction up to the end-of-life. Nevertheless, for entire sites or systems sustainability assessment, other well-established approaches such as carbon accounting, based on Green House Gas Protocol (GHGP), or energy audits exist. The candidate component for sustainability assessment can be based on any number of criteria such as energy intensity of production, buy-to-fly ratio (i.e., the ratio between the mass of the input material used to produce a component to the mass of the final product), the complexity of its supply chain, amongst many others.

The next stage in the sustainability assessment framework is the Analysis stage. The candidate component's corresponding supply chain is uncovered and mapped in this stage. In determining the candidate component's corresponding supply chain, similar to the life cycle inventory phase of the LCA that will be explained shortly, foreground and background data can be used. Foreground data are the data inputs that can be collected within the boundaries of the production system, typically physically collected. Background data, however, rely on multiple sources and often requires making many assumptions and simplification due to the occasional absence of data. In mapping the production processes, several modelling techniques can be used. Such techniques include value-stream mapping (VSM), a lean modelling tool used to visualize a production process and identify inputs and outputs of each process along with value-adding activities, discrete-event simulation, or any other mapping technique (e.g., Sankey diagrams to model energy inputs and waste streams of manufacturing processes). After the production process is mapped, values for the selected KPIs are assigned, either from foreground (i.e., physical data collection) or background, which could be obtained from specialized software databases (e.g., Granta EduPack, ecoinvent etc.), or from literature sources.

The final, and most data-intensive and lengthy stage, is the LCA stage. As this method is well-established and widely used, it will only be briefly explained. The interested reader can refer to [3] for a comprehensive and thorough guide on LCA. In short, the first step is to set the goal and scope of the LCA study. The goal (why is the LCA study being performed), the functional unit (a quantitative depiction of the *function* that the candidate component performs within the LCA study) and the scope (the processes within the corresponding candidate component's supply chain that are accounted for) are determined. Next, in the life cycle inventory (LCI) step, an inventory of all the inputs (material, energy, water etc.) and emissions (CO<sub>2</sub>e, water, waste, etc.) is carried out. This step is time-consuming and requires the making of important methodological choices. Similar to the previous (Analysis) stage, foreground and background data inventory the candidate component's production processes. The next step is the life cycle impact assessment step (LCIA) where the impact of the output of the preceding (LCI) step is determined. There are many methodologies for carrying out the LCIA step (e.g., ReCiPe 2016, IMPACT 2002 +, TRACI etc.). LCIA itself consists of several steps, but they are out of the scope of this paper as they are already contained within the LCIA methodologies. The selection of the methodology can be determined based on the geographical location of the study, the selected KPIs or on whether the results are required at the midpoint or endpoint levels. For more details about LCIA, the interested reader can refer to [8]. Finally, in the interpretation stage, the results of the LCI and



**Fig. 1.** The LCA-based sustainability assessment framework

LCIA are analysed, particularly with regards to the inherent uncertainty. To understand the impact of uncertainty on the results, sensitivity analysis is often used to uncover the impact that changes in the values of parameters (particularly those obtained from background data) can have on the study's outcome.

### 3 Industrial Case Study

In this section, a case study from the UK aerospace sector on a metallic structural component is carried out to demonstrate the applicability and usefulness of the sustainability assessment framework in the real world. The company is a Tier 1 aerospace components supplier that operates several factories worldwide. For confidentiality reasons, the name of the component will not be revealed, and the data presented in this section are normalised. In the Identification stage, the aerospace manufacturing company was concerned with the large amount of waste generated. Therefore, they chose buy-to-fly ratio to select the candidate component. The chosen component is a structural component made of aluminum alloy that the production company has identified as one of the most produced within their facility, and which also has a relatively high buy-to-fly ratio, which results in large amounts of waste.

The Analysis stage begins with mapping the production process of the chosen component. For this purpose, a simplified Sankey diagram has been chosen to model the production processes, material input, and waste streams, as in Fig. 2 below.

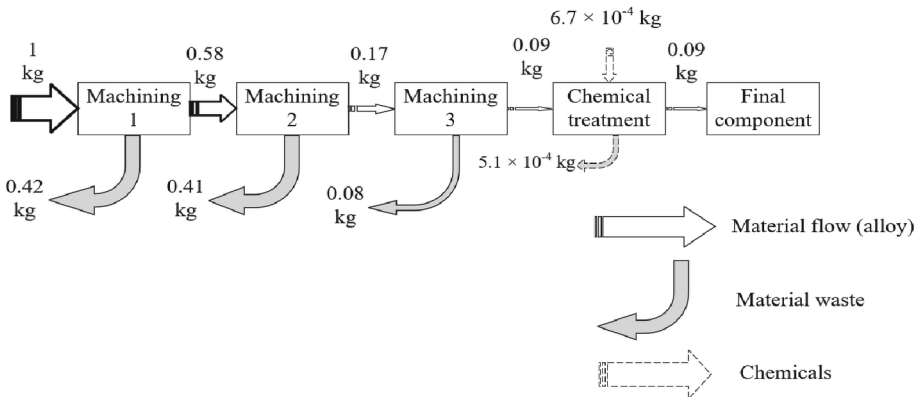


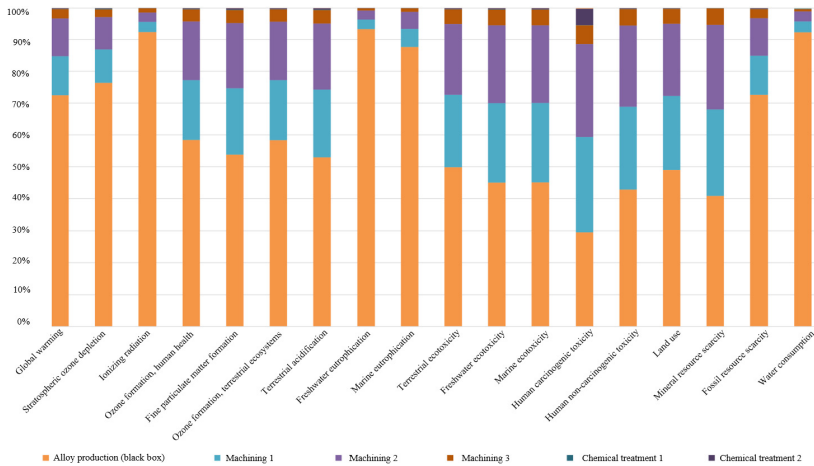
Fig. 2. The simplified production process of the chosen component

Figure 2 above depicts the gate-to-gate processes where the collection of foreground data was possible. For the upstream processes (i.e., material extraction, alloy production and transportation), these processes were taken as a black box, and their values were obtained from Granta EduPack 2021 R2 software. The box containing chemical treatment contains several (anodising) chemical treatment processes, but they have been combined in one box due to their very small amount.

The production process depicted in Fig. 2, along with the upstream alloy production (black box), was modelled in SimaPro 9.2 software. The background data for the life cycle inventory step were retrieved from the ecoinvent 3 database [9], a specialist LCI database for production processes, has been utilised. As for the LCIA process, the ReCiPe 2016 methodology [10] has been chosen. ReCiPe 2016, one of the most widely used LCIA methodologies, has been chosen due to its geographical coverage that covers Europe, where the study takes place, as well as the rest of the world, in addition to

including characterization factors for both midpoints and endpoints indicators. In this study, KPIs pertaining to about midpoint indicators have been chosen due to the more detailed information about environmental impacts midpoint indicators provide and the lower uncertainty associated with the outcome [8].

Results for the midpoint indicators, depicted in Fig. 3 below, reveal that the upstream processes of the alloy production, accounted for as black box, contribute the most for nearly all indicators. It should be noted in Fig. 3 that two chemical treatment processes were represented instead of one aggregate process as in Fig. 2. This is because the *amount* of chemicals used in the manufacturing processes was very small (almost negligible) when compared to the amount of metals used. In contrast, the *impact* of these chemicals – on certain midpoint indicators – was noticeable.



**Fig. 3.** LCIA results for the midpoint indicators

The near-domination of the alloy production on the overall cradle-to-gate processes of the candidate component can be attributed to several reasons. First, metal extraction occurs in disparate geographical areas around the world which, in addition to the highly polluting mining activities with the use of heavy equipment and energy and water-intensive processes [11] along with large amounts of waste and adverse changes to land use [12], also incurs long distances transportation. What also adds to the already considerable environmental impact of the early stages in the upstream activities of alloy production is that activities are often carried out in developing countries where the electricity mix is still highly reliant on coal due to its high energy density.

The above results have led the aerospace manufacturing company to intuitively realise that the majority of the environmental impact resulting from the manufacturing of the candidate components stems from elsewhere, and is, currently, difficult to mitigate. This fact is even further exacerbated when considering the environmental impact of the candidate component in its downstream life cycle (i.e., aircraft use phase and end-of-life solutions). Indeed, as discussed earlier in the Introduction section, it has

been found that as much as 99% of a commercial aircraft's (Airbus 320) entire environmental impact comes from the use phase of the aircraft over a period of 20 years [4]. Therefore, to improve the environmental impact of aerospace manufacturing processes, aerospace manufacturers should have tight control and transparent access to information about all upstream processes to come up with solutions to mitigate the environmental impact. Another solution is to adopt alternative materials and manufacturing technologies in aerospace manufacturing. This solution, however, is challenging as the aerospace manufacturing industry is tightly controlled and is subject to stringent regulations that require lengthy approval processes. Regardless of the challenges of using alternative materials, there is an upward trend in these aspects, particularly with regards to the use of composites [13] and additive manufacturing technologies [14]. Although these new materials and manufacturing technologies seem promising, there is a risk that the environmental impact might from one life cycle phase to another. To explain more, although composites are lightweight and contribute considerably to mitigating the environmental impact of the use phase, some of this environmental burden is shifted from the use phase to the manufacturing phase. In this particular example, the overall environmental gains outweigh the shift in the burdens throughout the life cycle.

## 4 Conclusion

In this paper, a context-independent LCA-based sustainability assessment framework for manufacturing processes is developed. The framework works as a decision-aid tool for identifying candidate components, and as an assessment tool to determine the environmental impact of the life cycle of the candidate component. The framework has been applied to a real case study in the aerospace sector for the production of a metallic structural component. Results from the case study revealed that most of the cradle-to-gate environmental impact comes from upstream processes (alloy production) that are outside the control of the aerospace manufacturing company. The main contribution of this work is twofold; first, the sustainability assessment framework, which brings LCA, a well-established structured methodology, into a wider set of guiding principles that facilitate the selection of candidate component(s) and relevant KPIs. The second contribution is the design of a real case study from the UK aerospace manufacturing sector where important remarks that can guide future decisions regarding improving the environmental profile were drawn, particularly with regards to the impact of upstream processes.

This research can be extended in several directions. First, and most obviously, although challenging and time-consuming, foreground detailed data regarding the upstream processes can be added to the LCA model. Such a detailed study would enable manufacturers to gain insight and control over upstream processes. It would also enable them to improve their environmental profile and ensure that the social aspects of sustainability, particularly far upstream in the supply chain, are handled fairly. Another possible research direction can be a comparative study comparing the current, as-is, production processes of the candidate component with future scenarios of alternative materials or manufacturing technologies such as those highlighted in the previous section.

## References

1. Salonitis, K., Ball, P.: Energy efficient manufacturing from machine tools to manufacturing systems. In: *Procedia CIRP*, pp. 634–639 (2013)
2. Sustainable development goals. United Nations. <https://sdgs.un.org/>. Accessed 16 May 2022
3. Hauschild, M.Z., Rosenbaum, R.K., Olsen, S.I. (eds.) *Life Cycle Assessment: Theory and Practice*. Springer, Cham (2018). <https://doi.org/10.1007/978-3-319-56475-3>
4. Howe, S., Kolios, A.J., Brennan, F.P.: Environmental life cycle assessment of commercial passenger jet airliners. *Transp. Res. Part D* **19**, 34–41 (2013)
5. Hodonou, C., Balazinski, M., Brochu, M., Mascle, C.: Material-design-process selection methodology for aircraft structural components: application to additive vs subtractive manufacturing processes. *Int. J. Adv. Manuf. Technol.* **103**(1–4), 1509–1517 (2019). <https://doi.org/10.1007/s00170-019-03613-5>
6. Hodonou, C., Kerbrat, O., Balazinski, M., Brochu, M.: Process selection charts based on economy and environment: subtractive or additive manufacturing to produce structural components of aircraft. *Int. J. Interact. Des. Manuf.* **14**, 861–873 (2020)
7. Witik, R.A., Gaille, F., Teuscher, R., Ringwald, H., Michaud, V., Månson, J.E.: Economic and environmental assessment of alternative production methods for composite aircraft components. *J. Clean. Prod.* **29–30**, 91–102 (2012)
8. Hauschild, M.Z., Goedkoop, M., Guinée, J., Heijungs, R., Huijbregts, M., Jolliet, O., et al.: Identifying best existing practice for characterization modeling in life cycle impact assessment. *Int. J. Life Cycle Assess.* **18**, 683–697 (2013)
9. Wernet, G., Bauer, C., Steubing, B., Reinhard, J., Moreno-Ruiz, E., Weidema, B.: The ecoinvent database version 3 (part I): overview and methodology. *Int. J. Life Cycle Assess.* **21**(9), 1218–1230 (2016)
10. Huijbregts, M.A.J., et al.: ReCiPe2016: a harmonised life cycle impact assessment method at midpoint and endpoint level. *Int. J. Life Cycle Assess.* **22**(2), 138–147 (2016). <https://doi.org/10.1007/s11367-016-1246-y>
11. Hisan, S., Huda, N., Mahmud, M.A.P., Saidur, R.: A review on the impact of mining and mineral processing industries through life cycle assessment. *J. Clean. Prod.* **231**, 1200–1217 (2019)
12. Kosai, S., Yamasue, E.: Global warming potential and total material requirement in metal production: Identification of changes in environmental impact through metal substitution. *Sci. Total Environ.* **651**, 1764–1775 (2019)
13. Brunner AJ. *Fracture mechanics of polymer composites in aerospace applications. Polymer Composites in the Aerospace Industry*. Elsevier Ltd; 2020. pp. 195–252
14. Blakey-milner, B., Gradl, P., Snedden, G., Brooks, M., Pitot, J., Lopez, E., et al.: Materials & Design Metal additive manufacturing in aerospace : a review. *Mater. Des.* **209**, 1–33 (2021)



**Open Access** This chapter is licensed under the terms of the Creative Commons Attribution 4.0 International License (<http://creativecommons.org/licenses/by/4.0/>), which permits use, sharing, adaptation, distribution and reproduction in any medium or format, as long as you give appropriate credit to the original author(s) and the source, provide a link to the Creative Commons license and indicate if changes were made.

The images or other third party material in this chapter are included in the chapter's Creative Commons license, unless indicated otherwise in a credit line to the material. If material is not included in the chapter's Creative Commons license and your intended use is not permitted by statutory regulation or exceeds the permitted use, you will need to obtain permission directly from the copyright holder.





# Concept for the Evaluation and Categorization of Sustainability Assessment Methods and Tools

Niklas Quernheim<sup>(✉)</sup>, Sven Winter, Lars Arnemann, Steffen Wolff, Reiner Anderl, and Benjamin Schleich

Department Product Life Cycle Management, TU Darmstadt, Otto-Berndt-Straße 2,  
64287 Darmstadt, Germany

quernheim@plcm.tu-darmstadt.de

**Abstract.** Sustainable product development is one key to avoid overshooting the global production resources and to keep the human impact on the climate under control. Life cycle assessment provides methods and tools to monitor and quantify processes. In reality however, this is a complex procedure with a lack of transparency and standardization. Especially small and medium enterprises lack resources and know-how to successfully perform life cycle assessments. Therefore, the need for action is to make methods and tools usable and accessible in practice. This paper presents a concept for the evaluation and categorization of sustainability assessment methods and tools by developing criteria based on a system context and stakeholder analysis. Proven assessment methods from literature and market research are the basis for the development of this concept. The final evaluation of exemplary solutions leads to research gaps which can be addressed in the future development of assessment methods.

**Keywords:** Life Cycle Assessment · Sustainable Product Development · Sustainability Assessment Methods and Tools · Life Cycle Engineering

## 1 Introduction

Since the Brundtland Conference in 1987, the goal of sustainable development of society has gained importance. Sustainable development is defined by the sustainable development goals as a target of the United Nations. In addition to being anchored in politics, the public awareness of sustainable development is growing and reaching companies and industrial production processes [1]. Sustainability is often represented using the triple bottom line (TBL), which includes the social, economic and ecological dimensions [2]. In order to establish sustainability considerations in the product development (PD) level, quantification methods are required. They can be used to evaluate different development stages of a product or, more commonly, at the end of life to assess a product retroactively. However, the quantification of sustainability is not trivial, since many influencing variables have an effect on it [3]. The methods developed so far still have numerous weaknesses, so that the results of an evaluation are rarely comparable and the implementation is often very complex. In addition, the large number of methods and

indicators creates an overload for product developers and customers [4]. Therefore, the aim of this research is to develop a concept to evaluate sustainability assessment methods and tools (SAMTs) and provide criteria for this purpose. The second chapter addresses sustainability in product development, SAMTs and the concept of life cycle assessment (LCA). Chapter three explains the main concept including the developed criteria which are used in an exemplary application in chapter four to illustrate a SAMT evaluation. Chapter five discusses limitations and emerging research needs before chapter six closes with a conclusion.

## 2 State of the Art

### Sustainability in Product Development

To achieve a sustainable PD, SAMTs are intended to help product developers to include aspects of sustainability in their considerations. The early phases are the most important, as this is where the main influences on TBL are established [5]. In order to achieve an improvement in sustainability, a variety of methods and tools exist which use different approaches to show or influence the sustainability of a product. Many SAMTs are based on performance measurement systems that use indicators of sustainability which represent measurable key figures. Depending on the company’s goals, vision and type of business, different indicator sets are used to develop methods for assessing sustainability. To represent applicability in the product life cycle (PLC) phases, SAMTs can be further divided into qualitative, semi-quantitative, and quantitative [6]. Qualitative SAMTs are suitable for easy and quick application at the beginning of the PLC. Quantitative assessments, on the other hand, achieve higher quality results but rely on accurate data and are used more towards the end of the PLC.

### Life Cycle Assessment

In order to measure the sustainability of a product, it is useful for a company to consider the influences on the product’s sustainability over the entire life cycle. LCA is a systematic procedure defined in ISO 14040/14044 that considers the inputs and outputs of processes during the PLC and assesses the impact of these on the environmental dimension. Essentially, a balance sheet is drawn up of the parameters relevant to the product during all phases of its life, and the environmental impact is then assessed with the aid of characterization models [7]. An LCA consists of four phases which are displayed in Fig. 1.



Fig. 1. Phases of a life cycle assessment according to ISO 14040/14044

Life cycle-based methods form the basis for many SAMTs and are specialized for different use-cases. In order to successfully select a solution for a specific problem, there is a need for concepts and selection criteria. This research builds on existing approaches.

### 3 Concept

Ernzer and Birkhofer [4] propose a three step approach to select the right LCA method based on company needs. Their first step is to analyze the wide variety of methods and structuring them into an organized pool. The main concept of this research builds on this first step and consists of criteria and categories for the structured evaluation of SAMTs. For this purpose, the system context is considered according to Pohl and Rupp [8] which places the SAMTs in context to the product development process (PDP). For a better understanding and applicability, the criteria are then aggregated into four categories which are displayed in Fig. 2. This chapter discusses the categories and highlights the development of the criteria and the system context analysis.

#### System Context Analysis

This section presents the analysis of the system context to derive criteria for the evaluation of a SAMT. The result is a series of requirements that are sorted and combined into criteria summarized in Fig. 2. The system context results in influences to a SAMT from two groups; external and internal influences. The first group includes laws, directives and regulations as well as documents and software. The first three can have an influence on the selection of a SAMT when it is used to achieve goals set by law. An example is the German law “Act on Corporate Due Diligence Obligations for the Prevention of Human Rights Violations in Supply Chains” [9], which sets requirements for responsible management of supply chains in order to improve the international human rights situation. Documents and software can dictate interfaces to company processes for a LCA tool. For example, the product data model might store the relevant information in different formats and structures which needs to be considered when choosing and implementing a SAMT.

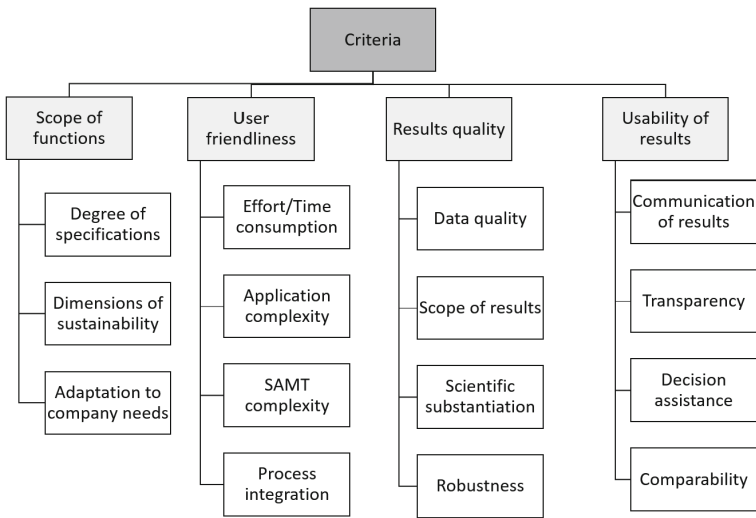
The second group are internal influences by stakeholders. These can be persons within the system context using a SAMT and having different prerequisites on know-how, expectations or use cases. This research identifies several groups of stakeholders and analyzes them regarding their familiarity with a given computer platform, their familiarity with the application area and their expected level of analysis detail. The stakeholders considered in this research are project managers, product developers, product manager, business manager, quality assurance, process planning, sales, marketing, customers, logistics and production staff. All groups use different software tools regularly so the integration in those tools can be significant. The level of know-how and the level of assessment detail influence the choice of SAMTs and must be included in the criteria.

In addition to stakeholder requirements, there are other requirements for a SAMT, so categorization features and criteria from the literature are used to further consider requirements (see [6, 10, 11]). These sources and the criteria from the literature research performed by Lindahl and Ekermann [12] substantiate the criteria developed in this research.

#### Criteria and Aggregations

Lindahl [13] finds four underlying criteria that a SAMT must fulfill. These are the easy adoption and implementation, fulfillment of specified requirements, reduction of the risk to forget important elements in the PD and the reduction of time to solve the task. The here

proposed criteria expand on these principles and ensure the evaluation and selection of a fitting solution. They cover the core functions of SAMTs and give users a methodology for a direct structured comparison. The developed criteria are then aggregated into four categories firstly without weighting, so that all criteria are considered equally. At this point the evaluation should be performed qualitatively due to the lack of standardization for SAMTs. The weighting for an individual application use-case can be added later based on the internal stakeholder requirements. Figure 2 shows the structure of the developed criteria. The first category is the scope of functions. It describes how many dimensions of sustainability the method covers, the extent to which the SAMT specifies how the assessment is to be carried out, and the extent to which it can be adapted to the needs of the company.



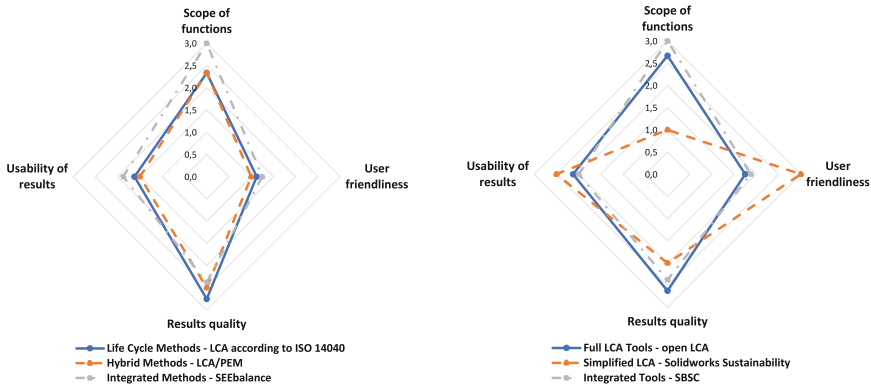
**Fig. 2.** Aggregated criteria for the structured evaluation of SAMTs

The degree of specifications describes whether the SAMT defines each step of the assessment or only outlines the framework conditions. In the latter, users must make many methodological decisions to perform an assessment and accordingly have a deeper knowledge. Dimensions of sustainability are based on the TBL. This criterion describes whether the solution is focused on the ecological dimension or includes social and economic components as well. Adaptation to company needs is also an important criterion, as the idea of a sustainability assessment is often derived from the corporate strategy. For example, the choice of sustainability key figures or the integration of company specific product category rules. The second category is user friendliness. The first criterion is the effort and time required to perform the SAMT. The application complexity of a given method describes the user perspective and distinguishes whether there are user guides or documentations and the overall description and presentation. The SAMT complexity includes the structure of the calculation models and how many indicators are considered. The last criterion is the integration of the SAMT into the PDP which describes whether a

SAMT is performed separately or integrated in the PDP and possibly even has interfaces to it. The third category is the quality of the results, which describes how accurate the results of a SAMT are. One factor influencing the quality of the results is the quality of the data, which describes whether quantitative or qualitative data are used. This is specific to the choice of SAMT and can be evaluated easily. At the same time, it is a key factor for analyzing the conflict between ease of use and the quality of results. Another aspect of this conflict is the scope of the results, describing the number of indicators to be analyzed. It is easier to assess for one company specific indicator than to cover a range of indicators used to prove the compliance with laws. The scientific substantiation is a measurement of how many case studies a method is supported by. The robustness and the handling of uncertainties of a SAMT describes whether a sensitivity analysis is provided and how uncertainties are included. The fourth category of criteria for a SAMT is defined by the usability of the results. This describes how the outputs from the SAMT can be used to incorporate and communicate aspects of sustainability into PD. It results from the way the SAMT communicates the results to the users and whether a decision support with possible suggestions takes place. For a high informative value of the evaluation results, transparency and comparability are important, so that they can be used for well-founded decisions. The criteria are intended as a foundation for a generalized method to evaluate SAMTs for a specific system context. The approach builds on the methodology of Ernzer and Birkhofer [4] and can be used by enterprises for an initial, qualitative analysis and selection of SAMTs.

## 4 Exemplary Application

In this section, the exemplary evaluation of SAMTs is performed using the developed criteria. Due to a paucity of data on many SAMTs and few use cases, a qualitative evaluation is conducted. The evaluation is based on case studies and the developer's descriptions of the methods as well as the authors' expert opinions after using the solutions. For the evaluation, each criterion is described by a catalogue of verbal components associated with quantitative values between 0 and 3 in order to compare the focuses of the different solutions. Figure 3 shows the evaluation of three methods and three tools. As a life cycle-based method, LCA according to ISO 14040 is evaluated and as a hybrid method the Partial Equilibrium Modeling (PEM) in combination with the LCA is analyzed. For the integrated method, the SEEBalance is used, which combines LCA with social LCA. These methods are widely used in practice and show an application of the proposed method. The criteria can be used to easily compare SAMTs with an LCA. The tool evaluation can be seen in the right graphic. OpenLCA is chosen for the full LCA tools, Solidworks Sustainability is used for the simplified LCA tools, and the Sustainable Balanced Scorecard (SBSC) is examined for the integrated tools. This chapter displays an excerpt of 22 total evaluated SAMTs over the course of this research.



**Fig. 3.** Evaluation results of the methods on the categories from the SAMT project. Left: Evaluation of the categories of the methods from the SAMT project based on examples. Right: Evaluation of the categories of the tools from the SAMT project based on examples.

The analysis shows that the methods based on LCA have a high quality of results, which is due to the high quality of the data, the scope of the analyses and a good scientific substantiation. Likewise, they are characterized by a high level of functionality, with SEEBalance standing out by covering all three dimensions. The usability of the results is only in the middle range due to the fact that the methods do not offer support for interpretation. Likewise, the user-friendliness is rather low, since these methods are very scientific and many methodological decisions have to be made in order to perform an evaluation. This also leads to a low comparability of the results. The tool openLCA improves the usability of the results compared to the normal LCA. This is achieved via integrated evaluation tools and an operation with the aid of a graphical user interface. The quality of the results is maintained and all dimensions of sustainability can be considered. This contrasts with the simplified LCA tool Solidworks Sustainability, which is tightly integrated into a CAD software. Predefined evaluation criteria increase usability, but impose a low level of functionality. The method has a comparatively low quality of results due to the lack of case studies. The SBSC is a method that is supposed to measure the performance of sustainability by adding sustainability to a classic balanced scorecard. This is very much dependent on the user, as only a basic framework for the evaluation is given. Thus, it has a very high functional scope and can show a high quality of the data. However, due to the high degree of freedom and low level of integration, it is only moderately user-friendly. Thus, it can be stated that the analyzed methods and tools mostly have a high range of functions and a high quality of results, but the user-friendliness is not very high. This can be increased by the use of a tool. Based on this exemplary evaluation, a user would have a choice of methods that differ in the dimensions of sustainability and slightly differ in data quality. But most importantly based on the individual expertise, they could choose between a user-friendly simplified tool with less functions and lower quality and complex solutions requiring know-how but offering high results quality.

## 5 Discussion

### Limitations

To ensure that all criteria are considered equally, a uniform weighting was used within the course of this research. Furthermore, the criteria provide indications for the evaluation, but should still be improved with the involvement of relevant stakeholders. In addition, some SAMTs are vaguely formulated and do not provide sufficient information. Experts or extensive transparency of the individual SAMTs are needed here. Ideally, this would involve a comparison of the different SAMTs in the context of a scientific study that looks at the same product for all SAMTs or a reflection of the methods by different experts and users. Therefore, the evaluation using the developed methodology still needs to be performed by an expert until more standards and comparable data exist.

### Research Needs

Based on the analysis of the SAMTs using the developed concept, there are certain required aspects of research which can be categorized in a practical and a theoretical perspective. Above all, there is a need for standards and validation of existing SAMTs through case studies to enable comparability. For this purpose, the proposed criteria can be used for example, to create databases of evaluated SAMTs. A practical continuation could be to develop weightings of the criteria for different business segments. Likewise, most solutions lack consideration of all three sustainability dimensions and assistance systems for making decisions based on the assessment. Furthermore, there is a need for a deeper stakeholder analysis for the further development and validation of the here proposed criteria.

## 6 Conclusion

Sustainability is becoming increasingly important in society, politics and also in product development. To assess sustainability and make the results reliable and comparable, methods and tools are needed. However, there are many different solutions without standardization. In order to create an overview and to make a suitable selection of SAMTs, this paper presents criteria and categories via requirements based on a system context analysis and stakeholder analysis. The criteria are then put to use in an exemplary evaluation of LCA methods and tools. The qualitative results reveal strengths and weaknesses of the SAMTs which enable an effective selection for the specific company needs and use cases. The proposed criteria therefore consider different stakeholders and requirements resulting from a system context analysis in order to perform a structured analysis of SAMTs.

**Acknowledgements.** This research is funded in the DiNaPro-project by the German Federal Ministry of Education and Research (BMBF) and implemented by the Project Management Agency Karlsruhe (PTKA). The authors are responsible for the content of this publication.



## References

1. Biermann, B., Erne, R.: Nachhaltiges Produktmanagement: Wie Sie Nachhaltigkeitsaspekte ins Produktmanagement integrieren können. Springer Gabler, Wiesbaden, Heidelberg (2020). <https://doi.org/10.1007/978-3-658-31130-8>
2. Elkington, J.: Enter the triple bottom line. In: *The Triple Bottom Line: Does it All Add Up*, vol. 11, pp. 1–16 (2004)
3. Hauschild, M.Z., Rosenbaum, R.K., Olsen, S.I. (eds.): Springer International Publishing, Cham (2018). <https://doi.org/10.1007/978-3-319-56475-3>
4. Ernzer, M., Birkhofer, H.: Selecting methods for life cycle design based on the needs of a company. *Proc. Des.* **2002**, 1305–1310 (2002)
5. Abele, E., Anderl, R., Birkhofer, H. (eds.): Springer, London (2005). <https://doi.org/10.1007/b138604>
6. Saurat, M., Ritthoff, M., Pihkola, H., et al.: SAMT - Sustainability assessment methods and tools to support decision-making in the process industries (2015). [https://www.aspire2050.eu/sites/default/files/project/samt/uploads/Modules/Publications/samt\\_d.1.2\\_final\\_v1.2.pdf](https://www.aspire2050.eu/sites/default/files/project/samt/uploads/Modules/Publications/samt_d.1.2_final_v1.2.pdf)
7. Su, D. (ed.): Springer, Cham (2020). <https://doi.org/10.1007/978-3-030-39149-2>
8. Pohl, K.: *Requirements Engineering: Fundamentals, Principles, and Techniques*. Springer-Verlag, Berlin (2016). <https://link.springer.com/book/9783642125775>
9. Act on Corporate Due Diligence Obligations for the Prevention of Human Rights Violations in Supply Chains: LkSG (2021)
10. Su, D., Ren, Z., Wu, Y.: Guidelines for selection of life cycle impact assessment software tools. In: Su, D. (ed.) *Sustainable Product Development*, pp. 57–70. Springer, Cham (2020). [https://doi.org/10.1007/978-3-030-39149-2\\_4](https://doi.org/10.1007/978-3-030-39149-2_4)
11. Wu, Y., Su, D.: Review of life cycle impact assessment (LCIA) methods and inventory databases. In: Su, D. (ed.) *Sustainable Product Development*, pp. 39–55. Springer, Cham (2020). [https://doi.org/10.1007/978-3-030-39149-2\\_3](https://doi.org/10.1007/978-3-030-39149-2_3)
12. Lindahl, M., Ekermann, S.: Structure for categorization of EcoDesign methods and tools. In: Nee, A.Y.C., Song, B., Ong, S.-K. (eds) *Re-engineering Manufacturing for Sustainability*, pp. 117–122. Springer Singapore, Singapore (2013). [https://doi.org/10.1007/978-981-4451-48-2\\_19](https://doi.org/10.1007/978-981-4451-48-2_19)
13. Lindahl, M.: *Engineering Designers' Requirements on Design for Environment Methods and Tools*. Dissertation, KTH (2005)

**Open Access** This chapter is licensed under the terms of the Creative Commons Attribution 4.0 International License (<http://creativecommons.org/licenses/by/4.0/>), which permits use, sharing, adaptation, distribution and reproduction in any medium or format, as long as you give appropriate credit to the original author(s) and the source, provide a link to the Creative Commons license and indicate if changes were made.

The images or other third party material in this chapter are included in the chapter's Creative Commons license, unless indicated otherwise in a credit line to the material. If material is not included in the chapter's Creative Commons license and your intended use is not permitted by statutory regulation or exceeds the permitted use, you will need to obtain permission directly from the copyright holder.





# Techno-Economic Assessment of Biogas to Liquid Fuel Conversion via Fischer-Tropsch Synthesis: A Case Study of Biogas Generated from Municipal Sewage

Munashe Katiyo<sup>1</sup>, Loice Gudukeya<sup>2</sup>(✉), Mufaro Kanganga<sup>3</sup>, and Nita Sukdeo<sup>2</sup>

<sup>1</sup> University of Zimbabwe, Box MP167, Harare, Zimbabwe

<sup>2</sup> University of Johannesburg, Kingsway Avenue Auckland Park, Johannesburg 2092, Gauteng, South Africa

loicekmg@gmail.com

<sup>3</sup> Gwanda State University, Gwanda, Zimbabwe

**Abstract.** This research looks at how biogas (a renewable energy resource) can be harnessed using municipal sewage waste, and the potential of biogas use for generating liquid fuels (diesel and petrol) using Fischer Tropsch synthesis. The research also looks at the economic implications of carrying out the venture, and also determines the viability and feasibility of developing such an initiative in Zimbabwe. The production of biofuel from biogas via Fischer Tropsch synthesis was successfully simulated using the Aspen Plus simulation software which enabled a techno-economic assessment to be conducted based on these results. The minimum retail price of Fischer Tropsch diesel and petrol fuel was determined to be slightly under \$1.10/litre for both fuels, with an annual total plant production capacity of 200 million litres per year. The plant was designed to produce around 270 000 L of petrol fuel per day that can be refined and further upgraded to premium quality grade petrol for export. The plant was also designed to produce nearly 320 000 L of diesel fuel per day for direct use as liquid transportation fuel. The total biogas input requirement for the plant is 700 tonnes/hour of biogas (2000 m<sup>3</sup>/hour) [1m<sup>3</sup> = 0.353 tonnes]. The total sulphur production is 30 tonnes per day, and the total carbon dioxide extracted and captured is 1500 tonnes per day. The total plant cost was estimated at \$200 million USD. The financial analysis for the plant operations shows positive financial performance with a nearly 20% return on investment. A payback period of 5 years is projected.

**Keywords:** Fischer-Tropsch · Biogas · Fuel Conversion

## 1 Introduction

Zimbabwe's fuel situation requires a holistic approach to ensure successful and efficient liquid fuel provision across all sectors, especially the local transportation sector. Unavailability of enough fuel affects productivity. Limited productivity affects optimum resource utilization as well as the economic output of the country. This results in stunted

economic growth, hence a poorer standard of living [1]. A method of producing diesel and petrol fuel from biogas generated from municipal sewage is proposed in this research to determine its effectiveness in contributing towards alleviating the diesel and petrol shortages sometimes experienced in Zimbabwe. The economic feasibility of the proposed venture is also assessed. Biogas can be converted to the liquid biofuels diesel and petrol using Fischer-Tropsch synthesis. The process route of biogas to Fischer Tropsch liquid fuel conversion includes the following steps [2]:

- 1) Biogas cleaning for the removal of impurities
- 2) Biogas reforming for the production of synthesis gas (syngas)
- 3) Upgrading of synthesis gas to remove carbon dioxide ( $\text{CO}_2$ )
- 4) Fischer-Tropsch synthesis for diesel fuel and petrol production.

This research looks into the feasibility of generating biogas from municipal sewage collected from specific municipalities within the Harare city council, and then determining the liquid transportation fuel yield (diesel and petrol) that can be produced by the Fischer-Tropsch process using the biogas yield. In this research, a process based simulation model for the biogas to liquid fuel plant is developed. The model also conducts the mass and energy balances. A techno-economic assessment is ultimately carried out to evaluate the technical viability and economic feasibility of producing Fischer-Tropsch liquid transportation fuel from biogas in Zimbabwe.

## 2 Literature Review

Fischer-Tropsch synthesis is a catalyzed chemical reaction in which synthesis gas, a mixture of carbon monoxide ( $\text{CO}$ ) and hydrogen sulphide ( $\text{H}_2\text{S}$ ), is converted into gaseous, liquid as well as solid hydrocarbons, together with a large enough amount of oxygenates (J.G Speight, 2014). This process is an important option for the environmentally friendly production of liquid transportation fuels from biodegradable resources and natural gas. Biogas is a viable option that can be used in the place of natural gas, whilst producing a more or less similar yield of liquid fuel. In essence, compared to petroleum derived diesel and petrol the equivalent fraction of diesel and petrol obtained from the Fischer-Tropsch process produces considerably less hydrocarbons, no sulphur oxides ( $\text{SO}_x$ ) or nitrogen oxides ( $\text{NO}_x$ ) hence is more environmentally friendly [3].

The process is performed under non-boiling conditions in order to maintain the reaction medium in a liquid state. An elevated temperature (i.e. one above ambient temperature) is used, preferably one that is about  $100^\circ\text{C}$  and most desirably within the range between  $150^\circ\text{C}$  and  $200^\circ\text{C}$ . Preferred operating pressures are those between the range of 1 atmosphere to 2 atmospheres.

### 2.1 Biogas Potential in Harare: Municipal Sewage Treatment

The capital city of Zimbabwe, Harare, faces serious water management problems. Harare drains its water into Lake Chivero while also taking in raw water from the same reservoir. In this way, the lake serves as a sink for pollutants that are not effectively removed via

wastewater treatment or reuse mechanisms. All processed sewage is dumped into this lake. Wastewater is believed to be the major direct and indirect source of pollution in Lake Chivero (Moyo, Nhapi, et al., 2007). Possible solutions for limiting wastewater inflows into Lake Chivero include processing the wastewater prior to its release into the lake. An overall water pollution mitigation strategy consists of three important components highlighted below:

- (i) A three-step strategic approach [4] (how to approach the problem),
- (ii) A differentiated approach (where to do what: residential, commercial and industrial areas) and
- (iii) A staged approach (when to do what: that is, the short-, medium- and long-term action plan).

## 2.2 Principle of the Anaerobic Digestion Process

Anaerobic digestion is an organic microbiological process in which micro-organisms derive energy and grow by metabolizing organic material in an oxygen-free environment, resulting in the production of methane ( $\text{CH}_4$ ). The anaerobic digestion process can be separated into the following four phases, with each phase requiring its own characteristic group of micro-organisms for completion:

- i. Hydrolysis: The conversion of non-soluble biopolymers to soluble organic compounds
- ii. Acidogenesis: The conversion of soluble organic compounds to volatile fatty acids and carbon dioxide  $\text{CO}_2$
- iii. Acetogenesis: The conversion of volatile fatty acids to acetate and hydrogen gas  $\text{H}_2$
- iv. Methanogenesis: The conversion of acetate and  $\text{CO}_2$  plus  $\text{H}_2$  to methane gas

## 2.3 Fischer-Tropsch Synthesis

Fischer-Tropsch synthesis is essentially a polymerization reaction in which carbon bonds are formed from carbon atoms that are derived from carbon monoxide, under the influence of hydrogen in the presence of a metal catalyst. Various metal catalysts can be employed such as cobalt, iron and nickel. The reaction leads to a wide range of products which depend on the reaction conditions and catalysts employed.

Fischer-Tropsch synthesis has drawn a great deal of interest in the recent decades from researchers. It has been believed that liquid hydrocarbons' production through this promising clean technology is a potential alternative method which could solve the shortage of liquid transportation fuels [7].

## 2.4 Fischer-Tropsch Synthesis Mechanisms

The Fischer-Tropsch synthesis surface polymerization reaction in which hydrogen and carbon monoxide react, takes place on the surface of the catalyst in situ. First, the reagents form monomer units. These monomer units act as building blocks for many

products, which are then subsequently polymerized to yield a wide range of larger products (mainly paraffins) ranging from  $C_1$  to  $C_{40}$  hydrocarbons (heavy wax products). Several simultaneous chemical reactions occur in the Fischer Tropsch regime producing both desired and undesired products. Polymerization of these blocks yields different products which depend on the thermodynamics and reaction kinetics of the system [5].

Alkanes are the most preferred products in the Fischer Tropsch process. The produced alkanes are mainly straight-chain hydrocarbons; while the alkene outputs are mostly tertiary alkenes [5]. Fischer Tropsch gas-to-liquids products are formed via the Fischer-Tropsch synthesis from a feedstock stream comprising carbon monoxide (CO) gas and hydrogen gas ( $H_2$ ), called syngas. As described above the syngas is formed from a reaction between methane and oxygen.

• ***This study is the first of its kind  $nCO + (2n + 1) H_2 \rightarrow C_nH_{2n+2} + nH_2O + \text{Heat}$  produced by Fischer-Tropsch synthesis.***

The Fischer Tropsch synthesis reaction products are a mixture of paraffin hydrocarbon compounds in whose molecules the carbon atoms number up to 100. In addition, co-products such as water of synthesis, unsaturated hydrocarbons and oxygen-containing compounds (alcohols and others) are generated. In industrial-scale production via Fischer Tropsch synthesis, the mixture of synthetic hydrocarbons produced is divided into the following product categories: liquefied petroleum gases (LPG), naphtha, kerosene and diesel fractions. Of these products LPG and naphtha, being primarily used as petrochemical feedstock, should not be regarded as ‘liquid fuels’, i.e. the primary objective of the Fischer Tropsch gas-to-liquids process is to produce liquid fuels. The primary focus is on the gasoline and diesel fractions.

### 3 Methodology

- ***Step 1:*** Physically determining the biogas potential of the Harare city council by considering the daily amount of sewage processed by select municipalities, then where necessary, extrapolating this value to estimate the total amount of biogas that the council could possibly provide.
- ***Step 2:*** Simulation of all processes required for the production of the liquid transportation fuels (diesel and petrol) from the biogas using the Fischer-Tropsch process, and determining the system design required to meet up with this requirement.
- ***Step 3:*** Development of a techno-economic model that includes all the financial assumptions of the system based on economic fundamentals.
- ***Step 4:*** The economic feasibility of the research project will be weighed by identifying investment considerations such as the capital costs of setting up the plant, the return on investment, as well as the potential economic savings that could be realized from this approach as opposed to fuel importation.
- ***Step 5:*** Literature review of the current application and adaptation of Fischer Tropsch synthesis of liquid transportation fuels in countries and locations where the technology is running in full swing is included as part of the methodology
- ***Step 6:*** Interviews will be scheduled and conducted with select individuals in the fuel and energy industry to get their insight regarding alternative local production of liquid transportation fuels via Fischer Tropsch synthesis in Zimbabwe.

- **Step 7:** Site/ Industrial assessment will be carried out through a detailed analysis of documentation and footage highlighting the Fischer Tropsch process as well as the design details of operational Fischer Tropsch plants around the world. Physical site visits to Fischer Tropsch synthesis plants are beyond the budget and scope of this research. There is no operational Fischer Tropsch plant in Zimbabwe to date.

## 4 Results Discussion

As part of the methodology to determine the viability of this project, questionnaires were used to get the insight of select individuals on the project. Questions were modeled and designed based on the project scope. Details of the opinions given by the respondents to the respective questions asked are available. The scoping-level economic assessment of this Fischer Tropsch gas to liquids system study is available, and all the costs are reported on a USD dollar basis. Capital expenditures include several elements that build up to a total plant cost. The bare costs cover the cost of the process equipment and the cost of the required associated facilities and infrastructure. The labor costs of installing the facility are also included. Total plant costs include the bare erected costs together with the engineering, procurement, and construction costs as well as the process and project contingency costs. The total as spent cost includes the interest on debt during the capital expenditure period, which for this study is taken to be five years.

Estimated capital costs and the capital expenditure are put together based on the functional processing area (synthesis gas production area, Fischer-Tropsch reactor area e.t.c). These cost estimates are consistent with the costs that were needed for constructing other gas to liquids processing facilities and have an expected accuracy of -15 percent to + 30 percent. Cost escalation and uncertainty between project execution and project completion have disrupted some Fischer Tropsch GTL projects in the past (e.g., Escravos and Pearl), giving an insight on how much caution needs to be put on Fischer Tropsch GTL cost estimates. For that reason, a probability significance test is carried out at the 95% significance level.

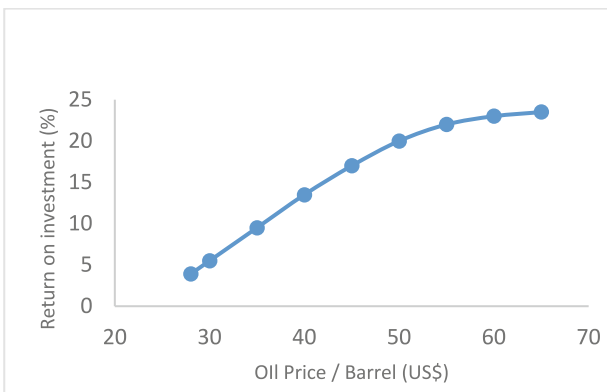
### 4.1 Results

This plant was designed to produce 270 000 L of petrol per day that can be refined to commercial grade gasoline. The plant was also designed to produce 320 000 of diesel fuel for direct use as liquid transportation fuel. The total biogas input requirement is 700 tonnes/hour of biogas (2000m<sup>3</sup>/hour) [1m<sup>3</sup> = 0.353 tonnes]. Total sulfur production is 30 tonnes per day, and total carbon dioxide capture is 1500 tonnes per day. The total plant cost including working capital and start-up costs, was estimated to be \$200 million USD. The financial analysis projection anticipates positive financial performance with nearly 20% return on investment. A payback period of 5 years is projected. Plant capacity factor has a strong impact on the financial returns. A capacity factor reduction of 25% would lower the return on investment from 20% to about 15%. Project viability depends heavily on crude oil price scenarios. At crude oil prices greater than \$35/barrel, the project would achieve a return on investment greater than 10%. A 15% return on investment is achievable for crude oil prices greater than \$45/barrel.

The plant construction cost was considered in the financial model and combined with the system structural engineering and design fees, as well as fees for office and administration work to provide the total cost estimate. On top of these costs, an approximation of 25% project contingency and 25% process contingency on the Fischer Tropsch synthesis section of the plant, 2% start-up cost, and 10% owner's cost was included to reflect the total plant costs.

The total plant cost and the values that are used in the financial model calculations are all rounded off to the nearest thousand, where the average cost is above \$1000USD. For cost values below \$1000USD, the value is rounded off to the nearest \$100 dollars. A 5% average increase in price/cost is included in all the cost figures to account for the uncertainty of market prices at any given time.

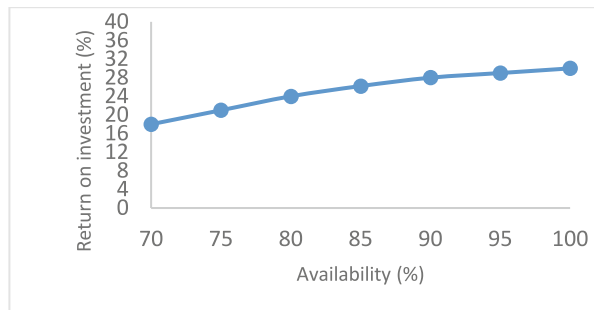
Net present value =  $(\text{Cash flow}) / (1 + r)^t$ , where cash flows is the money taken in by the venture through the selling of diesel and petrol,  $r$  is the discount rate and  $t$  is the time period under consideration. The base case result shows positive financial performance, with a nearly 20% return on equity investment and a net present value of around \$120 million. A mutual connection is established between the Fischer Tropsch liquids value and crude oil prices to determine how changes in crude oil price would impact the return on investment. Depending on the timeframe chosen as a comparison basis for pricing Fischer Tropsch liquid fuels, the financial results of the plant can be very different. Choosing a timeframe where crude oil prices are high by historic standards (e.g. the 2005–2006 period) will lead to Fischer Tropsch liquid fuel prices that are higher when compared to the average of prices for the last decade (2010–2020). Analysis performed on the petroleum market speculates that the 2005–2006 price average of near \$60/barrel for crude oil may represent a new basis for the future market predictions, rather than previous historic averages [8]. The impact that using a different basis for fuel price will have on plant ROI can be seen in the Fig. 1.



**Fig. 1.** The impact that using a different basis for fuel price will have on plant ROI

Using the 2000 to 2006 global price average of around (\$38USD /barrel) against any assumption made in the base case will drop the plant's return on investment by approximately 10 percentage points. Although the return in the mutually exclusive case

is still nearly 10%, project developers must be comfortable with the risks that are common in the fuel market and their exposure [7]. Price information from specific strong fuel markets of the Fischer Tropsch products and future projections for petroleum product prices are key in determining the economic viability of Fischer Tropsch plants. Ideally discussions should also be held with local importers of liquid fuel in Zimbabwe as well as with the product distributors to determine how they would value the Fischer Tropsch streams relative to petrol or diesel. Once this information is obtained, more refined price estimates can be made to determine the necessary price level to make the plant economically attractive. As highlighted above, the plant cost and plant availability also have a large impact on the return on investment. The base case financial analysis assumes a 25% project contingency and an additional 25% process contingency on the Fischer Tropsch synthesis plant in an effort to estimate uncertainty at this stage of the design. Because other model inputs are based on a percentage of the plant cost, changes in this variable has a multiplier effect on the overall economic results as shown in Fig. 2.



**Fig. 2.** Effect of model input on the overall economic results

Reliable operation is important to ascertain that the cost of project development and construction can be recovered. Long periods of non-operation throughout the life of the plant will negatively affect overall project economics, given the 30-year plant life. However, plant availabilities below 70% will still provide a decent return on investment of nearly 17%, which is only a few percentage points lower than the base case. This shows that the concerns over Fischer Tropsch plant performance should not be a major hindrance to project development, since potentially acceptable rates of return can be achieved even with lower than expected availability for this plant [9]. Based on the analysis where key process variables were changed by 25%, it can be stated that the project finance inputs are generally strong. The rates of return remain over 15% regardless of the variables changed, when using the base case values for Fischer Tropsch liquids. Besides project cost, the two items most critical to the financial analysis, which are availability and Fischer Tropsch liquids fuel value, can vary significantly based on plant design and market conditions. These variables should be carefully examined when considering the range of financial outcomes. Other inputs, while important to a detailed projected forecast of a facility's financial potential, do not have the same significant impact as these two factors [10].



## 5 Conclusion

This study is the first of its kind in the context of plant design studies for commercial scale Fischer Tropsch plants in Zimbabwe. The conclusions and recommendations from this study can feed directly into any follow on studies that may be carried out in Zimbabwe under the similar topic looked at in this project. The production of biofuel from biogas via Fischer Tropsch synthesis was successfully simulated using Aspen Plus simulation software. For the base case plant with a biogas firing capacity of 2 000 Nm<sup>3</sup>/h, the minimum selling price of Fischer Tropsch diesel and petrol fuel was determined to be slightly under \$1.10 per litre for both fuels, with an annual total plant capacity of 200 million litres/year (a constant price for the 2 fuels is taken since they go through fundamentally the same production process and are produced from the same biogas raw input). This selling price for the biofuels will be competitive judging from the retail price of fuel imported into Zimbabwe. Given the current drop in crude oil price during and after the Covid-19 pandemic, the economic feasibility of a biogas to Fischer Tropsch liquid fuels plant in Zimbabwe could be challenging. Nevertheless, a further drop in fuel price could be achieved at an even higher plant size with a much larger production capacity. Therefore, a biogas to liquids fuels plant has the potential for full commercialization and will compete with fossil-based diesel and petrol fuels in use in Zimbabwe. It therefore follows that the financial assumptions and contingencies put forward for this project hold, and are taken as valid since the project viability has been affirmed. In addition, any additional biofuels production from any other biofuels (ethanol and biodiesel) processing plants around the country will also add to the availability of liquid transportation fuels in the country.

### 5.1 Application of Fischer Tropsch Synthesis in Other Countries

The Fischer-Tropsch technology outlined in this paper can be used in many countries that have a source of raw gas feedstock for the process. The technology is already in use in a number of countries. The world's largest scale implementation of Fischer-Tropsch technology is a series of plants operated by Sasol in South Africa. The first commercial plant in the country opened in 1952. Sasol uses coal and natural gas as feedstocks for the Fischer Tropsch process. It produces different synthetic petroleum products, including most of the country's diesel. PetroSA, another company in South Africa, employs a refinery which produces 36000 barrels daily. Another large-scale implementation of Fischer-Tropsch technology is in Bintulu, Malaysia. The facility converts natural gas into low-sulfur diesel fuels and wax. The production scale is 12 000 barrels per day (1900 m<sup>3</sup>/d).

An additional Fischer Tropsch facility, Pearl GTL at Ras Laffan, Qatar, is the second largest Fischer Tropsch plant in the world behind Sasol's Secunda plant in South Africa. It uses a cobalt catalyst at a temperature of 230 °C. The plant converts natural gas to petroleum liquids at a rate of 140 000 barrels per day (22 000 m<sup>3</sup>/d). Additional production of 120 000 barrels (19000 m<sup>3</sup>) of oil equivalent in natural gas liquids and ethane is also observed. Another plant in Ras Laffan, Oryx GTL, was commissioned in 2007. It has a production capacity of 34 000 barrels per day (5400 m<sup>3</sup>/d). The plant makes use

of the Sasol slurry phase distillate process, which utilizes a cobalt catalyst. Oryx GTL is a joint venture between Qatar Petroleum and Sasol.

## References

1. Ahmad, N., Lequiller, F., Marianna, P.: 'Comparing growth in GDP and labour productivity: measurement issues'. *Journal* **7**, 1–2 (2003)
2. Shah, M.S., Halder, P.K., Shamsuzzaman, A.S.M., Hossain, M.S., Pal, S.K., Sarker, E.: Perspectives of biogas conversion into Bio-CNG for automobile fuel in Bangladesh. *J. Renew. Energy* **2017**, 1–14 (2017). <https://doi.org/10.1155/2017/4385295>
3. Speight, J.G.: Gasification of unconventional feedstocks, Article 1 p. 3 (2014)
4. Nhapi, I., Siebel, M., Gijzen, H.J.: The impact of urbanization on the water quality of Lake Chivero, Zimbabwe. *Water Environ. Manage.* **18**(1), 44–49 (2004)
5. Heidemij, T.: Catalysis. Volume IV. Hydrocarbon synthesis, hydrogenation and cyclization. *J. Am. Chem. Soc.* **79**(3), 760 (1957)
6. Doustdar, O., Wyszynski, M.L., Mahmoudi, H., Tsolakis, A.: Enhancing the properties of Fischer-Tropsch fuel produced from syngas over Co/SiO<sub>2</sub> catalyst: lubricity and calorific value. *IOP Conf. Ser. Mater. Sci. Eng.* **148**, 012092 (2016). <https://doi.org/10.1088/1757-899X/148/1/012092>
7. NETL: FE/NETL CTS-Saline Cost Model. (DOE/NETL-2013/1596) (2012)
8. RostrupNielsen, J.R.: *Syngas in Perspective*. Elsevier Science (2002)
9. Hoek, A.: *The Shell GTL Process: Towards a World Scale Project in Qatar: the Pear Project* (2006)





**Open Access** This chapter is licensed under the terms of the Creative Commons Attribution 4.0 International License (<http://creativecommons.org/licenses/by/4.0/>), which permits use, sharing, adaptation, distribution and reproduction in any medium or format, as long as you give appropriate credit to the original author(s) and the source, provide a link to the Creative Commons license and indicate if changes were made.

The images or other third party material in this chapter are included in the chapter's Creative Commons license, unless indicated otherwise in a credit line to the material. If material is not included in the chapter's Creative Commons license and your intended use is not permitted by statutory regulation or exceeds the permitted use, you will need to obtain permission directly from the copyright holder.





# Model-Based Method for Low-Effort Part-Specific CO<sub>2</sub>-Accounting During the Production on Machine Tools Using PLC Data

Erkut Sarikaya<sup>(✉)</sup> , Astrid Weyand , Dominik Dück , and Matthias Weigold 

Institute for Production Management, Technology and Machine Tools (PTW),  
Otto-Berndt-Straße 2, 64287 Darmstadt, Germany  
e.sarikaya@ptw.tu-darmstadt.de

**Abstract.** Against the backdrop of advancing climate change, the pressure on industry as the second largest producer of greenhouse gas emissions worldwide is increasing. Climate neutrality and the effects on the climate of products or services are gaining more and more political and social attention. Thus, this paper is dedicated to the investigation of the holistic influence of machined components on greenhouse gas emissions. Optimisations can only be achieved through a profound understanding of the important factors in relation to climate neutrality of industrial production. To this end, a method is developed that allows the low-effort quantification of part-specific greenhouse gases emitted during the production on a CNC machine tool. Validating experiments are conducted in a real industrial environment. Finally, potential for improvement is outlined.

**Keywords:** CO<sub>2</sub> emission · Sustainable production · Manufacturing

## 1 Introduction

As the second largest emitter of greenhouse gases worldwide [1], industry with its energy demand represents a relevant lever for minimising emissions. Thereby, discrete manufacturing, especially with cutting machine tools, is a major contributor in relation to other sectors [2]. To be able to estimate the climate impact of products, CO<sub>2</sub> balances, also called product carbon footprints, are drawn up. Carbon footprints are a special form of life cycle assessments (LCA). While with a LCA, it is possible to balance many environmental impacts of a product over its life cycle, the CO<sub>2</sub> balance only considers the impact category of climate change with the impact indicator global warming potential (GWP) [3]. It is commonly expressed in the unit CO<sub>2</sub> equivalents (CO<sub>2</sub>-eq.). This introduces a reference value that relates all greenhouse gases and their climate impact to the anthropogenic greenhouse gas with the largest share regarding climate change, CO<sub>2</sub> [4]. In the literature, the focus in regard to machine tools and produced parts has so far been primarily on energy efficiency [2, 5, 6], or in CO<sub>2</sub> monitoring without considering all relevant factors, such as raw material and cutting tool [7]. Thus,

the influence of the energy consumption as well as other factors like raw and operating materials on climate change has been less researched in connection with the production of produced parts. Furthermore, studies that address this topic usually require external measurement devices, which impair the application of the developed concepts in practice due to related costs. In addition, only geometrically predefined components are examined. Furthermore, the data used in these studies, especially for the global warming potentials (GWP) of the different materials or energies, are based on numerous different studies, making the comparability of these factors and thus the balance problematic [8]. Therefore, this work aims to fill the gap in literature and investigates a low-cost, brown-field approach for part-specific CO<sub>2</sub>-accounting of milled parts, including all relevant resources and using only one database for GWP factors. The method for CO<sub>2</sub>-accounting integrates internal machine tool data and enables fully automated CO<sub>2</sub>-accounting. This can be used by companies in several ways, e.g. to identify possible improvement measures, but also to provide the product carbon footprint for downstream-costomers. For these purposes, a cradle-to-gate system boundary is chosen. The concept is developed on the basis of the standard presented by the Green House Gas (GHG) Protocol [9] and the database for global warming potential offered by ecoinvent [10].

## 2 Method

In the following, the method for part specific CO<sub>2</sub>-accounting is described in general. It consists of three steps. First, the scope and relevant factors are defined according to the GHG. This is followed by the data collection and build-up of resource consumption model, emphasising the challenges and respective solutions to collect needed data at low-cost and with as little effort as possible.

### 2.1 Method for CO<sub>2</sub>-Accounting

The carbon footprint for the finished product is calculated as the sum of the carbon emissions (CE) of the input and output resources as well as transportation emissions. Therefore, the first step of the method, depicted in Fig. 1, is the definition of the system boundary, determining which resource inputs are needed in the process, which resource outputs respectively waste is leaving the process and which transportation related with these resources is considered. The challenge, however, is to get the information regarding the related emissions for each part separately. The typical approach is to measure the resource consumption for example with stationary or temporarily mounted sensors, having the disadvantages of high costs or not constant data acquisition. Therefore, they are hardly to include in a constant, part-specific CO<sub>2</sub>-accounting. Another challenge in accounting part-specific carbon footprints of milled parts are resource consumptions that can hardly be recorded from external sensors. Here, additional information from machine control and employees, supported by temporary measurements, can help to model the resource consumption part-specifically. This model for the calculation of the part-specific carbon footprint is created in step two of the method. The resource consumption is modelled based on permanent information gained from the programmable logic controller (PLC) as well as the product lifecycle management (PLM), uniquely aligned

with additional information from employees as well as temporary measurements. To get the part-specific carbon footprint as output, the consumption is then multiplied with the GWP factors for each resource, one-time gathered from an LCA-database. In a third step, the carbon footprint related to the product can be analysed and visualised.

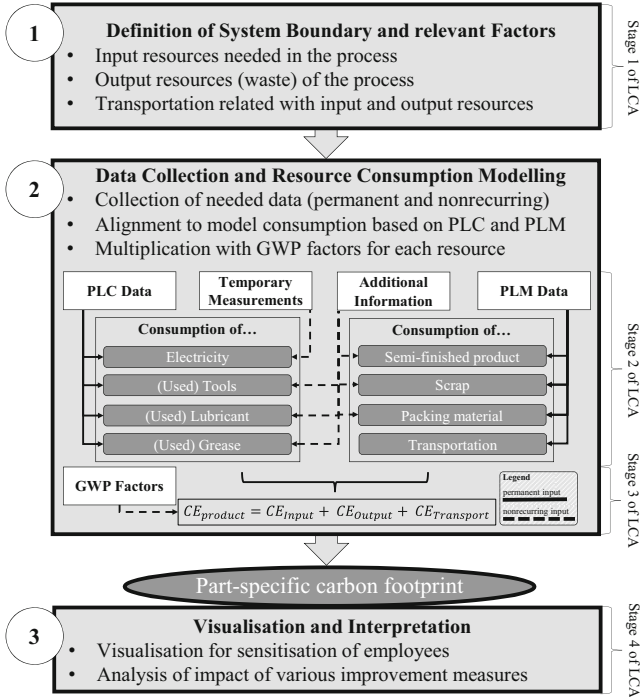
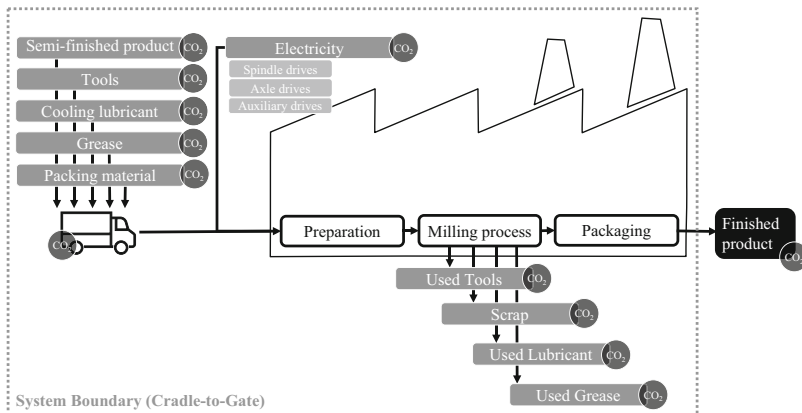


Fig. 1. Method for model-based, part-specific CO<sub>2</sub>-accounting

### 2.2 System Boundary and Relevant Factors

Figure 2 shows the relevant factors (in grey) for a part-specific CO<sub>2</sub>-accounting of milled parts (in black). They can be divided into the required input resources semi-finished product, cutting tools, coolant lubricant, grease, packaging material and electricity. Furthermore, the outputs scraps, used tools, used lubricants and used grease account also for CO<sub>2</sub>-emissions when being disposed, which therefore need to be considered for the carbon footprint of the finished product as well. The electricity needed for production can be further divided regarding the electrical consumers of today’s CNC machine tools. Electrical energy is mainly needed for spindle drives, axle drives and auxiliary drives. The auxiliary drives include for instance the chip conveyor, the air compressor, the cooling unit for cooling the spindle bearings and the clamping units for tools and workpieces.

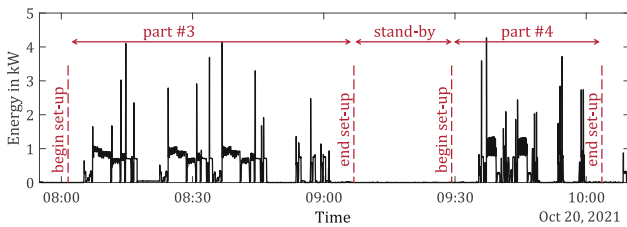


**Fig. 2.** Input and output resources regarding the finished product

### 2.3 PLC Data-Based Resource Consumption Model

Today's CNC machine tools have a very high automation level where almost all functionalities are provided from the machine controller. Hence, various information, such as the machine status, several on/off states, tool ID or drive signals, can be obtained from the PLC. This enables an effortless opportunity to gather relevant data for CO<sub>2</sub>-accounting on various machines without necessarily installing stationary measurement devices. According to the relevant factors identified, data from the electrical consumers spindle drives, axle drives and auxiliary drives must be collected during production. In addition, the operating time of each cutting tool must be recorded for being able to contrast them with the tool life cycle. Material and scrap information is obtained from master data of PLM system. The energy consumption of the spindle and axle drives depend strongly on the process and show highly dynamic changes which, therefore, need to be measured quantitatively. These can be obtained by measuring the current and voltage signals from the PLC. These variables are usually accessible from the machine controller since they are necessarily used in the control loop of a CNC machine tool. In contrast, the auxiliary drives show low-dynamic and cyclic behaviour. Hence, collecting the on/off states of these consumers is sufficient. Besides electricity, the auxiliary drives consume further resources such as cooling lubricant and grease which must be considered. These resource consumptions can also be modelled from the PLC due to constant supply behaviour. The on/off state of the aggregates are therefore multiplied with the characteristic supply value contained in the additional information. The CO<sub>2</sub>-accounting of used tools mainly depends on the relation between tool life cycle and cutting time. As a life cycle criterion, the tool wear is commonly used [11]. Since tool wear depends on several parameters, such as cutting conditions, tool properties and workpiece material, the life cycle varies continuously. Therefore, empirical equations, such as Taylor's tool life formula [12], are commonly used to predict the life cycle based on historical data. On the other hand, the cutting time can be accessed during production from the PLC by using the tool ID and spindle speed. The cutting time can then be cumulated whenever spindle speed is not zero. The produced scrap can either be obtained on field by respectively

weighing the workpiece before and after production or by using CAD/CAM software. Since CAD is the today's standard in product development, it is obviously preferable due to less effort. A part-specific CO<sub>2</sub>-accounting requires an allocation of the collected data to each manufactured part, as depicted in Fig. 3. This can be enabled by using the different operating states of the machine. According to VDMA 34179 [13] the operating states can be divided into working, operational, powering up, powering down, stand-by and off. The 4 first-mentioned states can be directly assigned to each part. For the allocation of the collected data during stand-by, however, a cause-related methodology must be worked out. The part-specific allocation of stand-by data can be designed with different complexity and must be in compliance with production planning. In batch production, a batch-wise allocation is suitable, while for one-off production only the distribution per predefined number of shifts or per predefined time span is appropriate. In the latter case, for example, the produced emissions during stand-by can be evenly distributed to all produced parts within one working day, a week or a month.

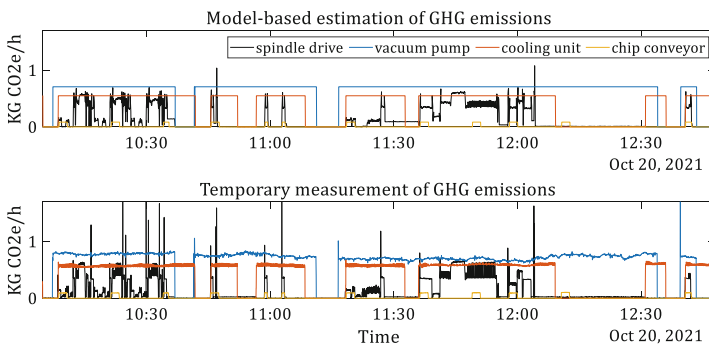


**Fig. 3.** Exemplary demonstration of part-specific data allocation within two produced parts

### 3 Use Case

The implementation has been realised in a real manufacturing environment where CNC machine tools are used for small batch production. The machine used consists of a 3-axis portal milling machine with a vacuum workpiece clamping technology and uses minimum quantity lubrication. Within the validation period, a total of 14 different components were manufactured. The machine operator has recorded the set-up times of the workpieces in order to be able to assign the set-up times to the carbon footprint later as well. Workpiece material and scrap information is obtained from PLM system. The required sensor data are collected by the machine controller as well as by temporarily measuring devices for model parametrisation and validation purposes. For gathering machine control data an industrial edge computer has been used. Additionally installed measurement devices consist of a mobile power consumption measuring case and a volumetric flow meter. The installed volumetric flow meter measures the volume rate of supplied compressed air from the machine shop. The compressed air supply is also considered as an electrical consumer. Therefore, the available control system of the machine shop compressor is used to determine the demand of electrical power to generate one liter of compressed air. This parameter is then related to the measured volume rate.

As already mentioned above, the electrical emissions generated during production can be modelled by means of machine internal PLC data. Figure 4 exemplarily shows the model-based estimated as well as the measured GHG emission curves of the spindle, the cooling unit, the chip conveyor and the vacuum pump during the production of two different workpieces. The model is parameterised and validated by comparison with external measurements (temporary measurements). Direct energy measurements from the control cabinet with current clamps confirm that the consumptions of the various auxiliary aggregates show almost constant signal behaviours during the measurement period. Thus, the emissions of these units can be approximated by recording their on/off states, while spindle and axle drives must be measured quantitatively. The model can estimate the emissions of the electrical consumers with an average accuracy of approximately 92%.

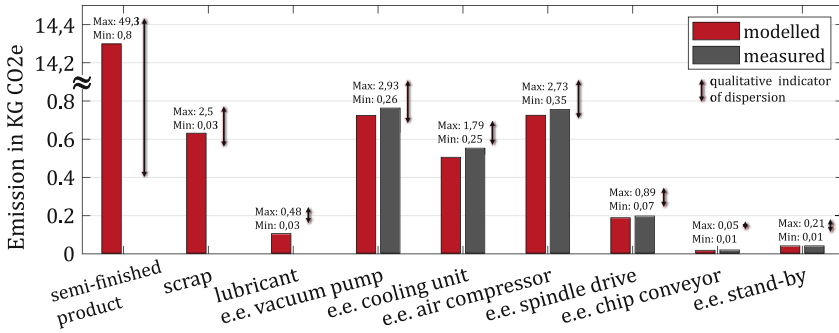


**Fig. 4.** Comparison between estimated and measured GHG emissions of selected auxiliary drives and the spindle drive

## 4 Results and Discussion

The concept developed in this paper allows the quantification of part-specific emissions during production considering all relevant factors from Fig. 2. In total, 244 kg of CO<sub>2</sub>e were emitted within three working days, with 14 individual parts produced. With an annual production capacity of 3811 parts, this corresponds to 66 t of CO<sub>2</sub>e per machine. This is comparable with 44 passenger cars with an annual mileage of 10.000 km [14]. Figure 5 breaks the emissions down to the individual resources. The bar chart presents the resource-related average CO<sub>2</sub> emissions. It includes the material, used lubricant and the electrical consumers. However, the axle drives, grease, tool wear and packaging have not been taken into account in Fig. 5 due to their negligible impact in this use case. Obviously, the individual resources differ significantly from each other. By far the largest source of emissions is the manufacturing of the semi-finished product. On average for the 14 different components produced, almost 83% of CO<sub>2</sub>e emitted are attributable to raw material. With 13,4% the machine internal consumers are the second largest contributors. The generated scrap is responsible for the remaining 3,6% of the greenhouse gases emitted.





**Fig. 5.** Resource-related average CO<sub>2</sub> emissions including material, lubricant and electrical consumers (e.e. = electrical emissions)

In a direct comparison of the electrical consumers, the air compressor, the vacuum pump and the cooling unit account for 91% of the greenhouse gases emitted. Spindle drive and chip conveyor in turn only account for 9% of the emissions from electrical consumers. The greatest possible lever for reducing emissions is the semi-finished product. An increase in the proportion of recycled aluminum by 30% can achieve an emission reduction of 58%. Another relevant lever is the greenhouse potential of the purchased electricity. By switching to electricity generated by solar energy, 7,1 t of CO<sub>2</sub> equivalent can be saved annually. Consequently, this paper concludes that switching to more climate-friendly resources, such as recycled aluminum, and switching to renewable energy are the most effective factors for climate-friendly production.

## 5 Conclusion

In the presented work a low-effort method for part-specific CO<sub>2</sub>-accounting during the product development phase of milled parts has been presented. The method is based on resource consumption modelling and uses PLC and PLM data as permanent inputs. Therefore, the method is arbitrarily scalable and highly automatable and thus provides an important contribution to CO<sub>2</sub> transparency and its emission reduction. An implementation in a real manufacturing environment showed good results for the modelled carbon footprint compared with the measured footprint of various products. The presented results are highly dependent on the data used. Especially, the greenhouse potentials for the resources have a significant impact on the balance sheet. For example, the results of the balance sheet differ by over 90% from the results presented, if the value for the primary aluminum is taken from the ProBas instead of the ecoinvent database. Therefore, the comparability of this study with other studies is only given if both are based on the same database. Although several resources were considered for the carbon footprint of the final product, further research has to include superordinate resource consumption such as electricity for lighting and heating of the factory side. Allocation can be done in this case for example by area share of the used machines.

**Acknowledgements.** This research is funded in the “DiNaPro” project by the German Federal Ministry of Education and Research (BMBF) and implemented by the Project Management Agency Karlsruhe (PTKA). The authors are responsible for the content of this publication.

## References

1. Ritchie, H., Roser, M.: CO<sub>2</sub> and Greenhouse Gas Emissions. Our World in Data (2020)
2. Denkena, B., Abele, E., Brecher, C., Dittrich, M.-A., Kara, S., Mori, M.: Energy efficient machine tools. *CIRP Ann.* **69**(2), 646–667 (2020)
3. Hottenroth, H., Joa, B., Schmidt, M.: Carbon Footprints für Produkte: Handbuch für die betriebliche Praxis kleiner und mittlerer Unternehmen. Monsenstein und Vannerdat, Münster (2014)
4. NOAA Global Monitoring Laboratory: The NOAA Annual Greenhouse Gas Index (AGGI). <https://gml.noaa.gov/aggi/aggi.html>. Accessed 14 Dec 2021
5. Schmidt, C., Li, W., Thiede, S., Kara, S., Herrmann, C.: A methodology for customized prediction of energy consumption in manufacturing industries. *Int. J. Precis. Eng. Manuf. Green Technol.* **2**(2), 163–172 (2015). <https://doi.org/10.1007/s40684-015-0021-z>
6. Sossenheimer, J., Vetter, O., Abele, E., Weigold, M.: Hybrid virtual energy metering points – a low-cost energy monitoring approach for production systems based on offline trained prediction models. *Proc. CIRP* **93**, 1269–1274 (2020)
7. Jeswiet, J., Kara, S.: Carbon emissions and CES<sup>TM</sup> in manufacturing. *CIRP Ann.* **57**(1), 17–20 (2008)
8. Li, C., Tang, Y., Cui, L., Li, P.: A quantitative approach to analyze carbon emissions of CNC-based machining systems. *J. Intell. Manuf.* **26**(5), 911–922 (2013). <https://doi.org/10.1007/s10845-013-0812-4>
9. World Resources Institute (WRI), World Business Council for Sustainable Development (WBCSD). Greenhouse Gas Protocol. <https://ghgprotocol.org/>. Accessed 12 Dec 2021
10. ecoinvent. ecoinvent Database. <https://ecoinvent.org/the-ecoinvent-database/>. Accessed 12 Dec 2021
11. Brenner, D., Kleinert, F., Imiela, J., Westkämper, E.: Life cycle management of cutting tools: comprehensive acquisition and aggregation of tool life data. *Proc. CIRP* **61**, 311–316 (2017)
12. Astakhov, V.P., Davim, J.P.: Tools (geometry and material) and tool wear. In: Davim, J.P. (ed.) *Machining*, pp. 29–57. Springer, London. (2008). [https://doi.org/10.1007/978-1-84800-213-5\\_2](https://doi.org/10.1007/978-1-84800-213-5_2)
13. VDMA: Measurement instruction to determine the energy- and resource demand of machine tools for mass production (34179:2019–04). Beuth Verlag GmbH (2019)
14. Federal Environment Agency: Emission data: Greenhouse gas emissions in passenger transport - Graphic. [https://www.umweltbundesamt.de/themen/verkehr-laerm/emissionsdaten#verkehrsmittelvergleich\\_personenverkehr\\_grafik](https://www.umweltbundesamt.de/themen/verkehr-laerm/emissionsdaten#verkehrsmittelvergleich_personenverkehr_grafik). Accessed 15 Dec 2021

**Open Access** This chapter is licensed under the terms of the Creative Commons Attribution 4.0 International License (<http://creativecommons.org/licenses/by/4.0/>), which permits use, sharing, adaptation, distribution and reproduction in any medium or format, as long as you give appropriate credit to the original author(s) and the source, provide a link to the Creative Commons license and indicate if changes were made.

The images or other third party material in this chapter are included in the chapter's Creative Commons license, unless indicated otherwise in a credit line to the material. If material is not included in the chapter's Creative Commons license and your intended use is not permitted by statutory regulation or exceeds the permitted use, you will need to obtain permission directly from the copyright holder.



# **Product Design and Innovation**



# Approach to Reduce the Environmental Impact of a CNC Manufactured Product in the CAD Phase

Sven Winter<sup>(✉)</sup>, Niklas Quernheim, Lars Arnemann, Reiner Anderl,  
and Benjamin Schleich

Product Life Cycle Management, Technical University of Darmstadt, Otto-Berndt-Straße 2,  
64287 Darmstadt, Germany  
winter@plcm.tu-darmstadt.de

**Abstract.** CO<sub>2</sub> neutrality is an important goal for the upcoming years. It is necessary to ensure that greenhouse gases are emitted as few as possible, particularly for the development of new products. The most important decisions, with impact on the sustainability, are already made by the product designer during the virtual product development phase, such as raw material requirements, selected manufacturing process or thermal and surface treatments. Especially in the case of ablative processes (CNC), raw material has a major impact on the calculated carbon footprint of products.

In order to minimize the emissions of greenhouse gases in the virtual product development phase already, this paper presents an approach to provide assistance for the product designer regarding the ecological impact of his decisions. For this purpose, Life Cycle Assessment (LCA) methods are directly integrated into the CAD software. During the design process, the expected CO<sub>2</sub> equivalents of the largest influencing factor - the raw material - can be displayed which is observed for most cases of metal material. In addition, the savings potential for reducing the blank volume or changing the raw material is shown and a suggestion is made.

**Keywords:** Life Cycle Assessment · Sustainable Product Development · CAD · CAM · Assistance System · Multi Scenario Analyzer

## 1 Introduction

In this day and age, climate protection is one of the most difficult challenges. To master this challenge, the European Commission determines greenhouse gas neutrality for the European continent up to the year 2050. This overriding goal is known as the European Green Deal (EGD) and was introduced in December 2019 [1]. With this key project, there are two main tools in the European Union (EU) to reduce greenhouse gases: One of them is the EU climate protection requirement and the other one is the EU emissions trading. Within the trading system, there is a cap of the overall greenhouse gas emissions which will be scaled down year by year. This affects energy-intensive companies, particularly in the energy, production industry and air traffic sectors. These involved sectors have to

break new ground to reduce greenhouse gas emissions in view of keeping the limits that are set by the EU. Especially when it comes to a new product design, there should be an understanding which effect a new product has on the environment.

The engineering view of a typical product lifecycle can be divided in the phases product development, production, utilization and different end of life scenarios, such as recycling or disposal. Every phase has an impact on the environment but only the first phase of the product development can affect the emissions of all the following other phases. Usually the product developer has not a great knowledge about the different following scenarios of the product's lifecycle and the impact of his decisions. This begins with the choice of the raw materials and the production processes. Even if the product in the product development phase is just a digital model, the needed raw material for production can be seen as a degree of freedom. However, the production of the raw material has so many possible parameters that the product developer has no possibility to quantify the impact of his decisions.

When it comes to quantifying the impact of products on the environment Life Cycle Assessment (LCA) is a widely used method [2]. In the past decades, a variety of LCA methods and indicators on the environmental impact have been developed. Every single knot of the supply chain of a product can be quantified and converted into greenhouse gas equivalents or other factors. With this opportunity, it is possible to track the greenhouse gas impact, for example the mining of raw material or the production of energy. LCA tools are often standalone, complex applications that are used by experts. However, they are not designed to be used in the product development process. The software requires extensive knowledge of information that is missing in the design process [3]. Moreover, the LCA approach is not user friendly and too complex to use it in an easy way [4].

When it comes to metal materials and abrasive processes, the choice of the raw material has a significant impact on the overall environmental footprint of the product. An example of the impact can be seen in the evaluation of the production of a threading tool where the total amount of the CO<sub>2</sub>eq for the complete production is 1.493 kg. The raw material has an amount of 0.76 kg CO<sub>2</sub>eq which is 51% of the sum [5]. In this case, the biggest lever to minimize the carbon footprint is the raw material. By designing a new product for CNC milling, the product developer defines the required blank volume at the very first step with the design software. This blank volume is the base for the CAM simulation and the required raw material in the following milling phase.

In this paper an approach for a product developer assistance system for CNC manufactured products is presented. This assistance system aims to give user friendly information of the raw material impacts on the environment in the CAD phase even before CAM is performed and the concept is consequently independent of a machine strategy. Therefore, the methods of LCA are directly integrated in the CAD software and suggestions to reduce the environmental impacts are given.

## 2 Current Use of LCA Methods and Tools

LCA methods and tools are used in various ways to reduce the environmental impact in the manufacturing industry. They can be divided into traditional application after production, usage in the production process and usage in product development. The traditional application includes standalone LCA software after the product was produced.

Commonly used tools for LCA evaluation with huge databases themselves are SimaPro or GaBi [6, 7]. The scope can be classified into “cradle to gate” analysis or “cradle to grave” analysis with the aim to summarize the environmental impacts for internal or external use before the product is sold. In production processes there are diverse analyses and approaches aiming on the reduction of resource consumption, for example of machine components [8]. Moreover, there are some approaches that uses LCA methods in the product development phase. One of them shows that an integration of LCA methods into structural optimization strategies for eco-design can support designers to lower the impact of products in the design phase already [9]. A complete integration of an LCA tool into CAD software has already been developed by Dassault Systèmes with the sustainability tool for the CAD software SolidWorks [10]. After designing a product, a CAD user can analyze different environmental impacts of the product by using a dropdown menu with different scenarios. Different materials are included and a report can be exported. An approach to integrate LCA in the CAD/CAE environment is given by Fang et al. [11]. Besides the environmental analysis of CNC machine tools, a sustainable design index (SDI) is developed to show energy consumptions, costs, CO<sub>2</sub> emissions and different design strategies with integrated analysis.

The existing approaches are complex to use and great knowledge about the lifecycle of the product is assumed. Even if the designer has knowledge in using LCA methods, it takes time to apply existing tools and software plugins which is often not practicable. This results in a need for an easy to use assistance system for designers.

### 3 Integration Method into CAD Phase

The developed assistance system for product developers can be integrated into the graphical user interface (GUI) of the CAD software and so be called easily as a new feature or function in the design process. In this approach, the used CAD software is Siemens NX 1926 but it can also be adapted for other CAD programs. The feature is developed in a way that it can be used in every step of the design phase regardless of level of detail.

The assistance system consists of three parts. The first part is called “simplifier” and its function is picking the relevant information out of the CAD model for the further software processing and provide the final results. By activating the feature, the dimensions of the model are transmitted into the assistance system. Details of the model are simplified and the required blank volume for a CNC production is calculated. This could be a block or a cylinder with offsets fulfilling geometric tolerances and clamping device attachments. Usually, the blank volume is created later by the designer during CAM programming. In this case, the required blank volume is created automatically by the assistance system by calculating the boundaries and adding the offsets. After the simplification of the CAD model, the required information for a LCA is transferred to the second module of the assistance system.

The second part is called “multi scenario analyzer”. This module creates different LCA scenarios and contrasts these with regard to their environmental impact. The module replaces the complex and time-consuming user inputs into a LCA software tool and considers different points of view. No experience is required for using the automatic calculation. Inputs for the multi scenario analyzer are the blank volume dimensions,

metal material information and current (geo-)location of the user. With these inputs, a variation of different production scenarios is created based on expert knowledge.

A basic material for CNC milling is aluminum. To produce a block of aluminum different steps must be carried out which results in an enormous number of input parameters. To get to the final production step which represents a production of an aluminum block, five different inputs can be figured out. The inputs are aluminum fluoride, produced anodes from coke and bauxite as well as electricity and process heating. Every block has his own input until the materials are directly consumed as natural assets such as air, water or raw materials. To show the complexity of the aluminum block production scenario, the five inputs of the aluminum fluoride block are listed: bauxite, quicklime, hexafluoro silicic acid, sodium hydroxide and process heating from two different sources are needed to produce the aluminum fluoride. Outputs of the production step are the aluminum fluoride and production waste which is not displayed. Summed up for the whole process, over 2600 sub processes (inputs and outputs) are found only for this aluminum production scenario.

This specific production scenario is handed over to the third part of the assistance system. The main function in this part is the performance of the LCA. The common results of an LCA is the calculation of different environmental impacts. A variety of impact assessment methods can be used for this purpose. The methods address different impact categories. Examples are the “Baseline model for 100 years, based on Intergovernmental Panel on Climate Change 2013 (IPCC)” which considers the impact categories climate change – overall, biogenic or land use and transformation, the method “ReCiPe” which has different impact categories such as formation of photochemical ozone, eutrophication – freshwater or marine and the method “CML 2002” with impact categories resource use and fossil [12]. One of the most used methods in practice is the eco-indicator 99 [13]. The midpoint approach includes 11 impact categories which can be classified in the three main categories human health, ecosystem quality and resources. There are different units in the methods in relation to their impact category. The focus of the assistance system is to give an easy to use and easy to understand environmental impact calculation. Therefore, the method “ReCiPe Midpoint (H)” is selected because of the direct calculation of the climate change impact and the transparent implementation [14]. There are three different calculations for this method. The hierarchist (H) calculation fits best for the assistance system. It is based on policy principles regarding a timeframe of 100 years for global warming. The calculation creates the CO<sub>2</sub> equivalents (CO<sub>2</sub>eq) of the final product. This unit is used in the assistance system but it is also possible to export a full report about the other impact categories such as different ecotoxicities in kg 1,4 dichlorobenzene (1,4-DB) eq or terrestrial acidification in SO<sub>2</sub>eq. After the environmental impact calculation of the production scenario, the results are returned to the multi scenario analyzer. The tool is then going to find the optimal scenario relating to the environmental impact by variation of parameters and completely different scenarios. Therefore, established optimization methods are used. The most applied method in literature to integrate LCA optimization is the multi-objective optimization where the Pareto set is generated by an  $\epsilon$ -constraint method [13]. The calculated optimum is then handed over to the simplifier. Here, the calculation units are prepared for the graphical display in the CAD software plug-in.



## 4 Case Study

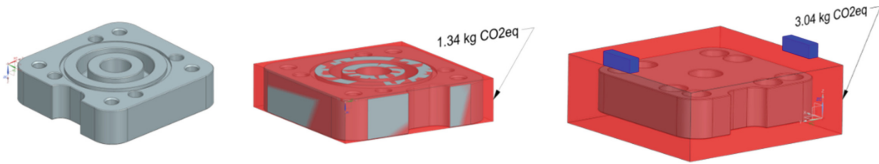
In this section, a practical execution of the support in the CAD pre-phase (before CAM simulation) is shown. Therefore, it is not necessary to have any knowledge in CAM simulation. The designer can operate the assistance system in his familiar feature-modeling environment. The investigated validation object is a part of a pneumatic cylinder which is manufactured in CiP - Center for Industrial Productivity (Process Learning Factory) at the Technical University Darmstadt by CNC milling. It is the top cover of the pneumatic cylinder assembly and can be seen on the left side in Fig. 1.

Inside the CAD software, the designer can activate the assistance system as a new feature or function in the main toolbar. The used software in this case is Siemens NX 1926. After activating the new feature, the model is analyzed by the simplifier and the relevant dimensions of the complete model are merged into a volume in which the hole model fits. This can be either a cylinder or a block volume. Both are created first and the volume with the smaller content is selected afterwards. This represents the minimum of the required blank volume for the CNC milling and a value of  $52737.50 \text{ mm}^3$  was determined. An offset of 5 mm in every direction is added which fulfills typical geometric tolerances for the milling process and clamping device attachments. The offsets in the different directions can be changed manually as well as the suggested positions of the clamping devices.

The assistance system checks now if there is a material assigned to the CAD model. In this case, an aluminum material without further details, such as alloys, is assigned in the CAD system. As a next step, different aluminum production scenarios will be considered. If no material is assigned, the tool checks different production scenarios for typical CNC metal materials. The first production process for aluminum depending on the user's location is created. The groundwork for this scenario is a pre-defined process in the ProBas + database. The LCA is performed with the ReCiPe Midpoint hierarchist (H) method. The first result is a climate change impact of  $32.32 \text{ kg CO}_2\text{eq}$  for the raw material with the required dimensions for the pneumatic cylinder top cover. After four more calculations of completely different aluminum production scenarios, a minimum is found at  $1.34 \text{ kg CO}_2\text{eq}$ . The high difference between the values is due to different variations in energy production in the different aluminum production scenarios. This value is transferred back to the CAD plug-in. Moreover, the minimum volume is shown and a report can be created for the other environmental impacts such as human toxicity or freshwater eutrophication of the detailed assumed production scenario. If no detailed report is required, the  $\text{CO}_2\text{eq}$  value can be stored in the CAD model as a product manufacturing information (PMI) as it can be seen in Fig. 1.

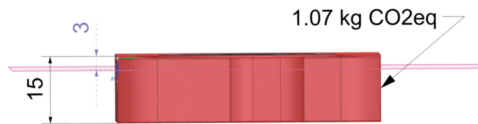
The minimum needed raw material block for the whole model can be seen in the middle. Typically, a raw material block has some kind of offset regarding to defined products by a manufacturer or attachments in the CNC machine. Moreover, geometric tolerances have to be fulfilled in the following manufacturing process. A minimum of 5 mm in every direction is a common offset to meet these requirements. The offset has a significant impact of the  $\text{CO}_2\text{eq}$  value for the raw material. The value increases by 127% to  $3.04 \text{ CO}_2\text{eq}$ .

A second feature of the assistance system is to give a recommendation to lower the environmental impact of the model. This could either be a change of material or



**Fig. 1.** Top cover of the pneumatic cylinder assembly (left), CO<sub>2</sub>eq of a minimum required aluminum block for the top cover without offset (middle) and with 5 mm offset and symbolic clamping attachments (right)

a change of dimensions. A minimum impact of the aluminum production was already determined. A suggestion for changing the material is given only if the material has not been specified before. For a block volume, the model is analyzed and different possible reductions are considered. One possibility is given in Fig. 2:



**Fig. 2.** Suggestion for a 3 mm reduction in height of the original CAD model to reduce CO<sub>2</sub>eq

The originally designed top cover has a height of 15 mm. The assistance system displays the reduction of the CO<sub>2</sub> equivalents if the general height of the CAD model is reduced. In this case, a reduction of 3 mm is shown. The CO<sub>2</sub> equivalents are proportional to the outer dimensions of the minimum box, so that the value decreases by 25 percent to 1.07 kg CO<sub>2</sub>eq. When the offset of 5 mm is also considered, a reduction by 13 percent to 2.67 kg CO<sub>2</sub>eq is calculated. The suggested reduction of the height of the original CAD model can also be manually be changed and the impacts are shown immediately.

## 5 Conclusion

LCA methods are the key to quantify environmental impacts of products. By quantifying the different impacts, decision-making in the design process of products can be optimized. Therefore, the LCA methods have to be integrated in the design process to visualize the environmental impacts. The usage of LCA methods is often complex and time-consuming, so that expertise is required. In a typical design process, the designer does not have LCA methods expertise which is why it is not possible to quantify the environmental impact of his decisions. When it comes to manufactured products by CNC, it is also a common practice, that the designer is not involved in the manufacturing process at all. Consequently, the designer has no expertise in using CAM simulations for the CNC process. The presented approach combines LCA methods and CAM simulations in a way that a designer can track the impacts of his decisions in the very first phase of the CAD model. Especially designing a whole new product, the environmental impact cannot be evaluated from existing manufactured product generations. Related on findings of literature and past research projects, the raw material of an CNC manufactured

product regarding metal materials has the biggest value of the environmental impact and in particular of the carbon footprint. This knowledge is used to implement an assistance system that calculates the environmental impacts and visualize the impacts as simply as possible. This leads to a designer's support without great knowledge neither in LCA calculations nor in CAM simulations. Furthermore, the assistance system is taking different production scenarios into account in order to get a minimum value of the CO<sub>2</sub>eq. This production scenario can be shown in a detailed report, so that transparency of the LCA calculation is given. Besides the CO<sub>2</sub>eq which represents an established value for climate change, other values can be seen in the report such as acidification or eutrophication.

In this approach, it is assumed that climate protection will be the most important goal in the upcoming years. Therefore, efforts must be made to keep the carbon footprint of new products as small as possible, even if not much information about the product is available yet. Currently, companies are faced with the conflicting goals of keeping the price as low as possible and the carbon footprint as small as possible. In certain situations, this does not go hand in hand and due to larger economic interests, the lower price is chosen. Policies in the coming years may change this towards high costs of CO<sub>2</sub> emissions or CO<sub>2</sub> equivalents and companies need to pay particular attention to the environmental impact of their decisions. In these decisions the presented approach should support a designer in an understandable and transparent way with simple assumptions.

Although it has been shown in past projects and literature that the raw material has the greatest influence factor in CNC production of metal materials, this still needs to be validated in further studies, especially in relation to the size of the product or a possible reduction of the offset. Of further interest are also the production costs, which must first be determined in order to integrate them into the model. In addition, other materials need to be investigated such as plastics. Also, the different metallic alloys for CNC milling and their post-processing needs to be balanced holistically. With regard to the selected production scenarios, it must be noted that companies are usually limited in their choice of suppliers. On the one hand, prices can be lowered if large quantities are purchased, and on the other hand, attention must also be paid to the availability of the required material. The assumed production scenario therefore represents an ideal case for minimizing the footprint. However, a new balancing of the environmental impacts must be carried out once the supply chain has been determined.

**Acknowledgments.** This research is funded in the DiNaPro-project by the German Federal Ministry of Education and Research (BMBF) and implemented by the Project Management Agency Karlsruhe (PTKA). The authors are responsible for the content of this publication.

## References

1. EUROPEAN COMMISSION - The European Green Deal (2019)
2. Wenzel, H., Hauschild, M., Alting, L.: Environmental Assessment of Products. Springer, Boston (1997). <https://doi.org/10.1007/978-1-4615-6367-9>
3. Bhamra, T.A.: An ecodesign model based on industry experience: IET Digital Library (1999). <https://doi.org/10.1049/ic:19990553>

4. Knight, P., Jenkins, J.O.: Adopting and applying eco-design techniques: a practitioners perspective. *J. Clean. Prod.* **17**(5), 549–558 (2009). <https://doi.org/10.1016/j.jclepro.2008.10.002>
5. Catalano, A.R., Debernardi, L., Balaso, R., Rubbiani, F., Priarone, P.C., Settineri, L.: An appraisal of the cradle-to-gate energy demand and carbon footprint of high-speed steel cutting tools. *Proc. CIRP* **105**, 745–750 (2022). <https://doi.org/10.1016/j.procir.2022.02.124>
6. Goedkoop, M., Oele, M., Leijting, J., Ponsioen, T., Meijer, E.: Introduction to LCA with SimaPro (2016)
7. PE International GmbH and University of Stuttgart, Chair of Building Physics, GaBi Modelling Principles (2007)
8. Duflo, J.R., et al.: Towards energy and resource efficient manufacturing: a processes and systems approach. *CIRP Ann.* **61**(2), 587–609 (2012). <https://doi.org/10.1016/j.cirp.2012.05.002>
9. Russo, D.: A computer aided strategy for more sustainable products. In: Cavallucci, D., de Guio, R., Cascini, G. (eds.) *Building Innovation Pipelines through Computer-Aided Innovation*. IAICT, vol. 355, pp. 149–162. Springer, Heidelberg (2011). [https://doi.org/10.1007/978-3-642-22182-8\\_12](https://doi.org/10.1007/978-3-642-22182-8_12)
10. Dassault Systèmes SolidWorks Corporation: *SolidWorks Sustainable Design An Introduction to Material Choice and Sustainable Redesign*, Engineering Design and Technology Series (2012)
11. Fang, F., Cheng, K., Ding, H., Chen, S., Zhao, L.: Sustainable design and analysis of CNC machine tools: sustainable design index based approach and its application perspectives. In: *Proceedings of the ASME 11th International Manufacturing Science and Engineering Conference 2016: Presented at ASME 11th International Manufacturing Science and Engineering Conference, June 27–July 1, 2016, Blacksburg, Virginia, USA* (2016). <https://doi.org/10.1115/MSEC2016-8730>
12. Finkbeiner, M., Bach, V., Lehmann, A.: *Environmental Footprint: Der Umwelt-Fußabdruck von Produkten und Dienstleistungen: Abschlussbericht TEXTE 76/2018* (2018)
13. Pieragostini, C., Mussati, M.C., Aguirre, P.: On process optimization considering LCA methodology. *J. Environ. Manage.* **96**(1), 43–54 (2012). <https://doi.org/10.1016/j.jenvman.2011.10.014>
14. Huijbregts, M.A.J., et al.: ReCiPe2016: a harmonised life cycle impact assessment method at midpoint and endpoint level. *Int. J. Life Cycle Assess.* **22**(2), 138–147 (2016). <https://doi.org/10.1007/s11367-016-1246-y>

**Open Access** This chapter is licensed under the terms of the Creative Commons Attribution 4.0 International License (<http://creativecommons.org/licenses/by/4.0/>), which permits use, sharing, adaptation, distribution and reproduction in any medium or format, as long as you give appropriate credit to the original author(s) and the source, provide a link to the Creative Commons license and indicate if changes were made.

The images or other third party material in this chapter are included in the chapter's Creative Commons license, unless indicated otherwise in a credit line to the material. If material is not included in the chapter's Creative Commons license and your intended use is not permitted by statutory regulation or exceeds the permitted use, you will need to obtain permission directly from the copyright holder.





# The LaST Tool – The Longevity and Sustainable Transition Tool

Peter Byrial Jensen<sup>1</sup>(✉), Louise Møller Haase<sup>1</sup>, Tim Cooper<sup>2</sup>, Joseph Steward<sup>2</sup>,  
Phillipa Marsh<sup>2</sup>, and Linda Nhu Laursen<sup>1</sup>

<sup>1</sup> Aalborg University, Aalborg, Denmark  
pbjen@create.aau.dk

<sup>2</sup> Nottingham Trent University, Nottingham, England

**Abstract.** Due to customers' increased focus on environmental sustainability, companies have been looking to position themselves as producers of consumer goods with greater longevity. Useful tools exist within academia to assist companies in this transformation process. However, the knowledge is scattered, and the focus of tools is often on either the mapping of companies' status quo or actionable solutions that increase the longevity of their products. Creating a common understanding and coherency to make the knowledge usable in practice has proven to be difficult, as an immediate match of the most appropriate action tools to the mappings does not exist. Therefore, there is a need for a practical transition tool that, in the process of mapping, assists companies in understanding their positions and potential and proposes suitable action tools to assist in the required change process for producing consumer goods with greater longevity. This could mitigate the challenges for practitioners and bridge the different types of tools, hence enabling companies to develop products with increased longevity more easily.

**Keywords:** Sustainability · Tool · Product Longevity · Circular Economy

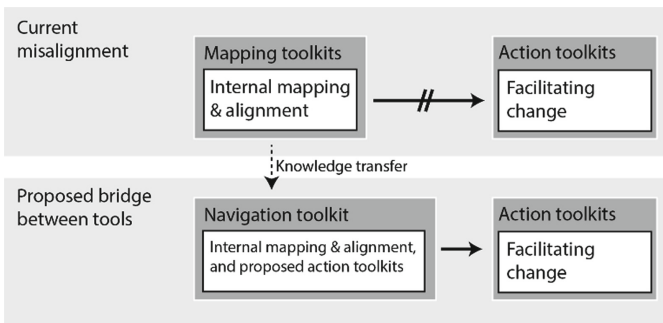
## 1 Introduction

Due to the rising global demand from consumers for sustainability, companies compete to position themselves in unique ways and deliver environmentally sustainable initiatives. Recycling, limiting plastic usage, lowering energy consumption and reducing production emissions have been among the main foci until now. However, the perception of product longevity as an important and effective element in the circular economy debate (Cooper 2020) and as a quality parameter (Cooper 2012) has raised demand for business and design methods to increase the longevity of their products. This paper adopts the definition presented by Bocken et al. (2016) that increased product longevity relates to slowing the consumption loop, with focus on the lifetime of a complete product including repair, multiple ownerships and remanufacturing but excluding recycling and upcycling, where the product is broken into sub-parts and used in new contexts.

For companies engaging with change towards producing consumer goods with greater longevity there exist several approaches, ranging from ways to increase the

physical durability of products to adapting product service systems into business models (Jensen et al. 2021.a; Kopecka et al. 2011; Verganti et al., 2011). How a company chooses to execute these can be difficult to decide in practice, however, as it depends on that company's attitude, willingness, investment and structure regarding the subject; consequently, the approaches suggested in the literature may be difficult for practitioners to utilise. This perception has also produced considerable fragmentation and theoretical confusion in academia. No common understanding exists regarding how to assist the navigation of an industry practitioner who aims to increase the longevity of their products (Bocken et al. 2019).

In this article, we adopt the perception that two types of tools exist for longevity: mapping and action. Mapping tools can provide a momentary view of a company's current situation, position and ambitions on a structural level towards product longevity. Action tools, on the other hand, are mostly focused on progress—how to enable change in a company and the necessary steps towards this. Hence, many tools already exist that can assist practitioners in most stages of product life and provide support in change towards developing viable products with greater longevity. Even so, it can be difficult for practitioners and researchers to define which insights to combine; it is challenging to translate the discoveries from the use of a mapping tool into more actionable tools and, in the end, into practically executable approaches (see Fig. 1).



**Fig. 1.** Misconnection between mapping tools and action tools, and the proposed new navigational tool that facilitates bridging the current literature.

To mitigate these challenges and move the field towards a more unified process, an integrative understanding is needed. We propose a new navigation tool, synthesising the existing mapping tool, which could provide a bridge between mapping and understanding possibilities and creating the required change. Hence, we propose the following research question:

*How can a new tool bridge existing mapping tools and action tools for product longevity to be more practically usable by industry practitioners?*

## 2 Research Approach

To address this research question, an in-depth identification of existing tools for product longevity is necessary.

## 2.1 Phase 1: Identifying Existing Literature on Product Longevity Tools

The literature for this paper was identified in a three-stage process. First, a screening of the literature in Bocken et al.'s (2019) review of circular business innovation tools provided a solid basis of 13 tools and broad coverage of the existing tools. Second, through a forthcoming review of tools for product longevity by Özçelik et al. (2022), five additional relevant articles were added. Two tools produced by research teams led by one of the co-authors were also added (Cooper et al. 2016, 2021). Furthermore, a broad database search across Scopus, SciTech Premium Collection, DOAJ, ABI/INFORM Collection and Springer Online Journals Complete was conducted using the search term “product longevity” AND “tool”, including peer-reviewed and open-access journal articles, book chapters and books. The search resulted in 124 articles that were screened, firstly by abstract then full text filtering, and narrowed down to 17 relevant papers on tools for longevity. In total, 37 articles were selected. App. 1 presents all the identified literature through the two-stage process and an overview of the format of the tools presented.

## 2.2 Phase 2: Clustering Types of Tools

As previously described, when looking at the identified literature on tools in App. 1, two major differences in the aims of the tools are apparent. On the one hand, several tools enable companies to understand their position broadly and assist in mapping out their aims, direction, goals and progression through a structured process. These are defined in this article as ‘mapping tools’. On the other hand, several tools guide participants through actionable suggestions for transformation; these are referred to as ‘action tools’ in this article. The distinction seen in the clustering is further emphasised by the mention in the existing articles by the authors that tools are used to understand either the current situation (mapping tools) or how to change it (action tools).

**Mapping Tools.** Mapping tools provide participants with increased insight into their company’s position and maturity, focusing on the general process at the managerial level and having a broad focus across different departments within a company. This can be helpful for practitioners aiming to produce consumer goods with greater longevity; however, evaluating the impact of a mapping tool is limited to the ability of participants to execute sub-activities that are often not thoroughly described. The identified mapping tool literature is displayed in App. 2. Because these tools vary in their approaches, focus and paradigm, they aim to help different stakeholders, so selecting the correct tool, that suit users’ situations, is crucial.

This understanding of the basis of the methodology is crucial for achieving transformation towards developing products with greater longevity. Likewise, the overview of the stakeholders combined with the mapping provides information for the evaluation and selection of areas approachable for transformation in a given company and the extent of the transformation.

**Action Tools.** There also exists a range of action tools aimed at subprocesses within the transformation process. These tools provide the necessary knowledge to overcome

the more specific challenges and barriers faced by designers or managers. However, participants need to be aware of their position, limitations and opportunities to successfully select the appropriate action tool. The identified action tool literature is displayed in App. 3. Through these tools, practical approaches to transformation should emerge that incrementally drive companies towards producing consumer goods with increased longevity.

### 3 Results of the Metatheoretical Analysis

The two types of tools have contrasting strengths and weaknesses. Using mapping tools and action tools in the most relevant practical situation can assist practitioners in making more knowledgeable decisions in the incremental change process. In an ideal situation, perceiving the process of using these tools can be seen as an iterative process that starts with a practitioner acknowledging the need for change, leading to the selection and execution of a mapping tool, followed by the use of action tools, which leads to practical change.

In some situations, to enable the use of action tools (App. 3) for the application of concrete actionable initiatives, practitioners need to be aware of their situation and opportunities. Existing mapping tools (App. 1) may provide an effective foundation for companies to increase awareness of opportunities, challenges and barriers, hence enabling them to make more conscious decisions regarding the selection of approaches and action tools. However, the current mapping tools lack a direct connection to the action tools and therefore do not bridge practical understanding and action.

### 4 Development of a Navigation Tool that Integrates Existing Knowledge and Bridges the Actionable Literature

We propose, with inspiration from the circular representation of product life in Sinclair et al. (2018), an overview of a product’s life as a circle. The circle is divided into three spatial levels indicating the main ownership and stakeholders responsible for the longevity of the product, namely the designers and developers, businesses and the user, inspired by the stakeholders identified by Jensen et al. (2021.b) in their exploration of barriers to product longevity (see Fig. 2).

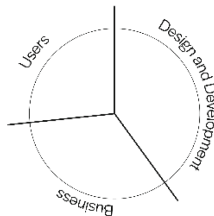
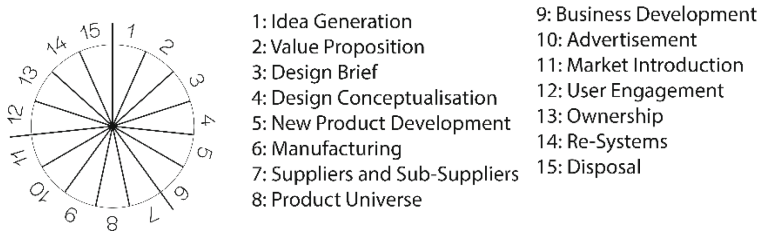


Fig. 2. Representation of product life, divided into three spatial fields in the LaST tool.

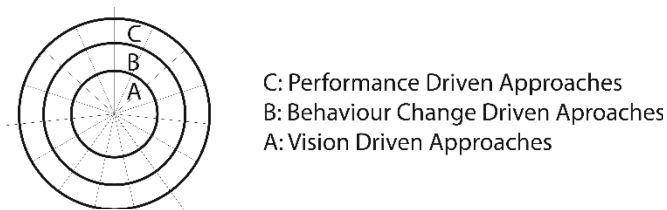


Based on the focus of the action tool, as seen in App. 3, the most influential life stages are included in the LaST navigational tool (Fig. 3). To bridge the LaST tool with the action tools (App. 3), the selection of the most relevant life stages is based on the life stages that the individual action tools mention and address, thereby aiming each subdivision of the spatial field towards appropriate action tools.



**Fig. 3.** Sub-divisions of the spatial fields into smaller subdivisions of product life.

To facilitate evaluation criteria for users of the LaST tool, evaluation parameters are likewise considered in the toolkit (Fig. 4.). These are based on the focus of proposed solutions, namely performance, behaviour or vision (inspired by Jensen et al. 2021.b). Performance-driven approaches mainly focus on the physical characteristics of products and their performance, while behaviour change-driven approaches focus on how businesses can influence customers and create more value through service, business model and behaviour. The vision-driven approaches include determining if the company’s approach to product longevity is a core value for it and collectively communicating the value of product longevity through product, business and customer engagement. The closer to the centre of the circle in each subdivision, the more holistic is the approach; the further away from the circle, the more product-orientated are the solutions presented. To incrementally move further towards the centre of the circle, action tools found in App. 3 that are linked to the specific subdivision can be applied.



**Fig. 4.** Evaluation parameters of the LaST tool.

## 5 Conclusion and Limitations

Current literature reveals a disconnection between tools that assist practitioners in identifying their potential in terms of product longevity and those that assist in making the

actual change. The main contribution of this paper is the creation of a navigation tool that binds together the knowledge from existing mapping tools and creates a direct link to the existing action tools, while facilitating the transition through incremental change in product life. The LaST tool could be used for companies that are inexperienced in considering product longevity and utilised repeatedly throughout a period, as incremental changes can facilitate continuous development within the field and improve the longevity of products. Participants are likely to benefit from repeating and adapting the methodology to new avenues of improvement, and it is important to explore newly discovered knowledge gaps or secondary business areas for improvement.

As highlighted by this paper, there are gaps within the connection between academia and practice in product longevity. An interesting avenue for future research might therefore be to investigate the connection between the action tools and the long-term impact on product longevity, company revenue and environmental implications. Likewise, an exploration of a company's willingness to adopt new and more explorative business models to improve product longevity could be valuable.

## Appendix:

**App. 1.** Complete list of the identified literature through Bocken et al. (2019), özçelik et al. (2022), co-authors and a supplementary literature search.

Author	Title
Mendoza J.M.F., et al. (2017)	Integrating Backcasting and Eco-Design for the Circular economy: The BECE Framework
Sinclair M., et al. (2018)	Consumer intervention mapping: A tool for designing future product strategies within circular product service systems
Hainess-Gadd, H., et al., D. (2018)	Emotional durability design nine-A tool for product longevity
Evans S. and Bocken N. (2014)	A tool for manufacturers to find opportunity in the circular economy
Heyes G., et al. (2018)	Developing and implementing circular economy business models in service-oriented technology companies
Whalen K., et al. (2018)	'All they do is win': Lessons learned from the use of a serious game for circular economy education
Whalen, K. (2017)	Risk and race: Creation of a finance-focused circular economy serious game
Bocken, N., et al. (2018)	Experimenting with a circular business model: Lessons from eight cases
Antikainen M., et al. (2017)	Circular economy business model innovation process—Case study

(continued)

*(continued)*

Author	Title
Bocken N., Miller K., Evans, S (2016)	Assessing the environmental impact of new circular business models
Manninen K., et al. (2018)	Do circular economy business models capture intended environmental value propositions?
Nußholz J.L.K. (2018)	A circular business model mapping tool for creating value from prolonged product lifetime and closed material loops
Pigosso D.C.A., et al. (2018)	Measuring the Readiness of SMEs for Eco-Innovation and Industrial Symbiosis: Development of a Screening Tool
Jensen, P. B., et al. (2021)	Barriers to product longevity: A review of business, product development and user perspectives
Dokter, G., et al. (2020)	Cards for circularity: Towards circular design in practice
Jensen, P. B., et al. (2021)	A practical approach to companies' transformation toward product longevity: A best-case study
Rexfelt, O., Selvefors, A. (2021)	The use2use design tool—Tools for user-centred circular design
Garza-Reyes, J. A., et al. (2019)	A circularity measurement tool for manufacturing SMEs
Cooper, T., et al. (2021)	Clothing Durability Dozen: Strategies to improve design and testing for clothing longevity
Cooper, T., et al. (2016)	Dirt, Damage, Servicing and Repair: Understanding motivations for product disposal
Roberts, D., and Hughes, M. (2014)	Exploring consumers' motivations to engage in innovation through co-creation activities
Hora, M., et al. (2016)	Designing Business Models for Sustainable Mass Customization: A Framework Proposal
Yang, M., et al. (2018)	The Management of Operations Product-service systems business models for circular supply chains
Wastling, T., et al. (2018)	Design for Circular Behaviour: Considering Users in a Circular Economy
Cherry, C. E., & Pidgeon, N. F. (2018)	Why Is Ownership an Issue? Exploring Factors That Determine Public Acceptance of Product-Service Systems

*(continued)*

*(continued)*

Author	Title
Wallner, T. S., et al. (2020)	An Exploration of the Value of Timeless Design Styles for the Consumer Acceptance of Refurbished Products
Albæk, J. K., et al. (2020)	Circularity Evaluation of Alternative Concepts During Early Product Design and Development
Terzioglu, N., & Wever, R. (2021)	Integrating Repair into Product Design Education: Insights on Repair, Design and Sustainability
Moalem, R. M., and Mosgaard, M. A. (2021)	A Critical Review of the Role of Repair Cafés in a Sustainable Circular Transition
Bocken, N. M. P., et al. (2015)	Value mapping for sustainable business thinking
Rogers, J. G., et al. (2015)	Product longevity and shared ownership: Sustainable routes to satisfying the world's growing demand for goods
Chapman, J. (2009)	Design for (Emotional) Durability
Boavida, R., et al. (2020)	A Combined Use of TRIZ Methodology and Eco-Compass tool as a Sustainable Innovation Model
Choi, Y. J., et al. (2018)	Carative Factors in the Design Development Process: Towards Understanding Owner–Object Detachment and Promoting Object Longevity
Haug, A., (2018)	Defining 'Resilient Design' in the Context of Consumer Products Defining 'Resilient Design' in the Context of Consumer Products
Gregori, E. J. S. P., and Wdowiak, I. K. M. A. (2021)	Entrepreneurial lean thinking for sustainable business modeling: a workshop design for incumbent firms
Rivera-torres, P. (2019)	Is It Possible to Change from a Linear to a Circular Economy? An Overview of Opportunities and Barriers for European Small and Medium-Sized Enterprise Companies

**App. 2.** List of mapping tools.

Author	Title	Type of situation where tool is applicable
Garza-Reyes, et al. (2019)	A circularity measurement tool for manufacturing SMEs	Measurement tool to identify SMEs' current maturity through an evaluation of circularity practices. Executed through a questionnaire
Sinclair M., et al. (2018)	Consumer intervention mapping: A tool for designing future product strategies within circular product service systems	Identifying the possible intervention points for companies to improve circularity in relation to customers. Executed through collective discussion of participants
Jensen, P.B., et al. (2021)	Barriers to product longevity: A review of business, product development and user perspectives	List of barriers that can hinder the development of products with high longevity. Serves as a foundation for the discussion of possible overlooked challenges
Pigosso D.C.A., et al. (2018)	Measuring the readiness of SMEs for eco-innovation and industrial symbiosis: Development of a screening tool	A screening tool to measure the readiness for SMEs to adopt circularity initiatives through discussion based on a questionnaire
Jensen, P. B., et al. (2021)	A practical approach to companies' transformation toward product longevity: A best-case study	Creates a foundation for understanding different maturity levels of companies, based on their perspective and focus in product, business and focus area

**App. 3.** List of action tools based on the identified literature.

Author	Title	Type of situation where tool is applicable
Dokter, G., et al. (2020)	Cards for circularity: Towards circular design in practice	Idea generation, design brief, and design conceptualisation process
Hainess-Gadd, H., et al. (2018)	Emotional durability design nine-A tool for product longevity	Design brief, new product development, Ownership
Rexfelt, O., Selvefors, A. (2021)	The use2use design tool—Tools for user-centred circular design	Idea generation and re-systems and Product Universe
Evans, S., Bocken N. (2014)	A tool for manufacturers to find opportunity in the circular economy	Idea generation, manufacturing, and business development
Heyes G., et al. (2018)	Developing and implementing circular economy business models in service-oriented technology companies	Business development
Mendoza, J.M.F. et al. (2017)	Integrating backcasting and eco-design for the circular economy: The BECE framework	Business development
Cooper, T., et al. (2016)	Dirt, Damage, Servicing and Repair: Understanding motivations for product disposal	Idea generation, design conceptualisation
Bocken, N., et al. (2018)	Experimenting with a circular business model: Lessons from eight cases	Value Proposition, Design Brief, and Design Conceptualisation
Antikainen M., et al. (2017)	Circular economy business model innovation process—Case study	Business Development and Market Introduction
Bocken N., et al. (2016)	Assessing the environmental impact of new circular business models	Manufacturing and Business Development
Manninen K., et al. (2018)	Do circular economy business models capture intended environmental value propositions?	Value Proposition, Design Brief, Business Development and Disposal

*(continued)*

*(continued)*

Author	Title	Type of situation where tool is applicable
Nußholz, J.L.K. (2018)	A circular business model mapping tool for creating value from prolonged product lifetime and closed material loops	Business development, Re-systems, and Market Introduction
Whalen, K., et al. (2018)	'All they do is win': Lessons learned from the use of a serious game for circular economy education	New Product development, Manufacturing and Suppliers and Sub-suppliers
Whalen, K. (2017)	Risk and Race: Creation of a finance-focused circular economy serious game	Business Development, advertisement, market introduction
Cooper, T., et al. (2021)	Clothing Durability Dozen: Strategies to improve design and testing for clothing longevity	Idea generation, Design Brief and Business development
Roberts, D., and Hughes, M. (2014)	Exploring consumers' motivations to engage in innovation through co-creation activities	Business development, User Engagement and Ownership
Hora, M., et al. (2016)	Designing Business Models for Sustainable Mass Customization: A Framework Proposal	Business Development, advertisement, and User Engagement
Yang, M., et al. (2018)	The Management of Operations Product-service systems business models for circular supply chains	Suppliers and sub-suppliers, Business Model
Wastling, T., et al. (2018)	Design for Circular Behaviour: Considering Users in a Circular Economy	User Engagement, Ownership, Re-systems
Cherry, C. E., & Pidgeon, N. F. (2018)	Why Is Ownership an Issue? Exploring Factors That Determine Public Acceptance of Product-Service Systems	Business Development, User engagement, and Ownership
Wallner, T. S., et al. (2020)	An Exploration of the Value of Timeless Design Styles for the Consumer Acceptance of Refurbished Products	New Product Development, Ownership, and Disposal

*(continued)*

*(continued)*

Author	Title	Type of situation where tool is applicable
Albæk, J. K., et al. (2020)	Circularity Evaluation of Alternative Concepts During Early Product Design and Development	Idea Generation, Design Brief, and Design Conceptualisation
Terzioglu, N., & Wever, R. (2021)	Integrating Repair into Product Design Education: Insights on Repair, Design and Sustainability	Design Conceptualisation and New Product Development
Moalem, R. M., and Mosgaard, M. A. (2021)	A Critical Review of the Role of Repair Cafés in a Sustainable Circular Transition	Ownership, Re-systems, and Disposal
Bocken, N. M. P., et al. (2015)	Value mapping for sustainable business thinking	Business Development, Market Introduction
Rogers, J. G., et al. (2015)	Product longevity and shared ownership: Sustainable routes to satisfying the world's growing demand for goods	Business Development, Re-systems, and User Engagement
Chapman, J. (2009)	Design for (Emotional) Durability	Design Conceptualisation, New Product Development, and Ownership
Boavida, R., et al. (2020)	A Combined Use of TRIZ Methodology and Eco-Compass tool as a Sustainable Innovation Model	Idea Generation, Design Brief, and Design Conceptualisation
Choi, Y. J., et al. (2018)	Carative Factors in the Design Development Process: Towards Understanding Owner–Object Detachment and Promoting Object Longevity	New Product Development, Ownership, and Disposal
Haug, A., and Haug, A. (2018)	Defining 'Resilient Design' in the Context of Consumer Products Defining 'Resilient Design' in the Context of Consumer Products	Design Conceptualisation, New Product Development
Gregori, E. J. S. P., and Wdowiak, I. K. M. A. (2021)	Entrepreneurial lean thinking for sustainable business modelling: a workshop design for incumbent firms	Business Development, User Engagement, and Ownership

*(continued)*



*(continued)*

Author	Title	Type of situation where tool is applicable
Rivera-torres, P. (2019)	Is It Possible to Change from a Linear to a Circular Economy? An Overview of Opportunities and Barriers for European Small and Medium-Sized Enterprise Companies	Business Development, Ownership

## References

- Albæk, J.K., Shahbazi, S., McAloone, T.C., Pigosso, D.C.A.: Circularity evaluation of alternative concepts during early product design and development. *Sustainability* **12**(22), 9353 (2020). <https://doi.org/10.3390/su12229353>
- Antikainen, M., Aminoff, A., Kettunen, O., SundqvistAndberg, H., Paloheimo, H.: Circular economy business model innovation process – case study. In: Campana, G., Howlett, R.J., Setchi, R., Cimatti, B. (eds.) *SDM 2017. SIST*, vol. 68, pp. 546–555. Springer, Cham (2017). [https://doi.org/10.1007/978-3-319-57078-5\\_52](https://doi.org/10.1007/978-3-319-57078-5_52)
- Boavida, R., Navas, H., Godina, R., Carvalho, H., Hasegawa, H.: A combined use of TRIZ methodology and eco-compass tool as a sustainable innovation model. *Appl. Sci.* **10**(10), 3535 (2020). <https://doi.org/10.3390/app10103535>
- Bocken, N. M. P., Miller, K., Evans, S.: Assessing the environmental impact of new circular business models. In: *The Proceedings of the First International Conference on “New Business Models”*, Toulouse, France, 16–17 June 2016 (2016)
- Bocken, N.M.P., Rana, P., Short, S.W.: Value mapping for sustainable business thinking. *J. Ind. Prod. Eng.* **32**(1), 67–81 (2015)
- Bocken, N., Schuit, C., Kraaijenhagen, C.: Experimenting with a circular business model: lessons from eight cases. *Environ. Innov. Soc. Trans.* **28**, 79–95 (2018). <https://doi.org/10.1016/j.eist.2018.02.001>
- Bocken, N., Strupeit, L., Whalen, K., Nußholz, J.: A review and evaluation of circular business model innovation tools. *Sustainability* **11**(8), 1–25 (2019). <https://doi.org/10.3390/su11082210>
- Chapman, J.: Design for (emotional) durability. *Des. Issues.* **25**(4), 29–35 (2009). <https://www.jstor.org/stable/20627827>
- Cherry, C., Pidgeon, N.: Why is ownership an issue? Exploring factors that determine public acceptance of product-service systems. *Sustainability* **10**(7), 2289 (2018). <https://doi.org/10.3390/su10072289>
- Choi, Y.J., Stevens, J., Brass, C.: Carative factors in the design development process: Towards understanding owner–object detachment and promoting object longevity. *Des. J.* **21**(4), 477–497 (2018). <https://doi.org/10.1080/14606925.2018.1468166>
- Cooper, T.: The value of longevity: Product quality and sustainable consumption. In: *Proceedings: Global Research Forum on Sustainable Consumption and Production Workshop*, June 13–15, 2012, Rio de Janeiro, Brazil (2012). <http://grf-spc.weebly.com/uploads/2/1/3/3/21333498/cooper-paper.pdf>
- Cooper, T.: Slower cycles: an essential characteristic of the circular economy. In: Eisenriegler, S. (ed.) *The Circular Economy in the European Union*, pp. 99–116. Springer, Cham (2020). [https://doi.org/10.1007/978-3-030-50239-3\\_9](https://doi.org/10.1007/978-3-030-50239-3_9)

- Cooper, T., Fisher, T., Harmer, L., Salvia, G., Barr, C.: Dirt, damage, servicing and repair: understanding motivations for product disposal. Technical report for Defra. London (2016). <http://irep.ntu.ac.uk/id/eprint/38866/>
- Cooper, T., et al.: Clothing durability dozen. 2nd edn. Nottingham: Nottingham Trent University (2021). [https://www.ntu.ac.uk/\\_data/assets/pdf\\_file/0035/1395494/30\\_04\\_21\\_NTU-DURABILITY-DOZEN-TOOLKIT\\_10-31.pdf](https://www.ntu.ac.uk/_data/assets/pdf_file/0035/1395494/30_04_21_NTU-DURABILITY-DOZEN-TOOLKIT_10-31.pdf)
- Dokter, G., Van Stijn, A., Thuvander, L., Rahe, U.: Cards for circularity: towards circular design in practice. IOP Conf. Ser. Earth Environ. Sci. **588**(4), 042043 (2020). <https://doi.org/10.1088/1755-1315/588/4/042043>
- Evans, J.L., Bocken, N.M.P.: A tool for manufacturers to find opportunity in the circular economy: [www.circulareconomytool.org](http://www.circulareconomytool.org). KES Transactions on Sustainable Design and Manufacturing, April 2014. <http://nimbustvault.net/publications/koala/inimpact/papers/sdm14-006.pdf>
- GarzaReyes, J.A., SaloméValls, A., PeterNadeem, S., Anosike, A., Kumar, V.: A circularity measurement tool for manufacturing SMEs. Int. J. Prod. Res. **57**(23), 7319–7343 (2019). <https://doi.org/10.1080/00207543.2018.1559961>
- Hainess-Gadd, M., Chapman, J., Lloyd, P., Mason, J., Aliakseyeu, D.: Emotional durability design nine – a tool for product longevity. Sustainability **10**(6), 1–19 (2018). <https://doi.org/10.3390/su10061948>
- Haug, A.: Defining ‘Resilient Design’ in the context of consumer products. Des. J. **6925**, 1–22 (2018). <https://doi.org/10.1080/14606925.2018.1395265>
- Heyes, G., Sharmina, M., Joan, M.F., Mendoza, A.G.-S., Azapagic, A.: Developing and implementing circular economy business models in service-oriented technology companies. J. Clean. Prod. **177**, 621–632 (2018). <https://doi.org/10.1016/j.jclepro.2017.12.168>
- Hora, M., Hankammer, S., Canetta, L., Consultant, S., Gahrens, S.: Designing business models for sustainable mass customization: a framework proposal. Int. J. Indus. Eng. Manage. **7**(4), 143–152 (2016)
- Jensen, P.B., Haase, L.M., Laursen, L.N.: A practical approach to companies’ transformation toward product longevity: a best-case study. Sustainability **13**(23), 13312 (2021). <https://doi.org/10.3390/su132313312>
- Jensen, P.B., Laursen, L.N., Haase, L.M.: Barriers to product longevity: a review of business, product development and user perspectives. J. Clean. Prod. **313**, 127951 (2021). <https://doi.org/10.1016/j.jclepro.2021.127951>
- Kopecka, J.A., Santema, S.C., Buijs, J.A.: Designerly ways of muddling through. J. Bus. Res. **65**, 729–739 (2011). <https://doi.org/10.1016/j.jbusres.2010.12.0097>
- Manninen, K., Koskela, S., Antikainen, R., Bocken, N.M.P., Dahlbo, H., Aminoff, A.: Do circular economy business models capture intended environmental value propositions? J. Clean. Prod. **171**, 413–422 (2018)
- Mendoza, J.M.F., Sharmina, M., Gallego-Schmid, A., Heyes, G., Azapagic, A.: Integrating back-casting and eco-design for the circular economy: the BECE framework. J. Ind. Ecol. **21**, 526–544 (2017)
- Moalem, R.M., Mosgaard, M.A.: A critical review of the role of repair café s in a sustainable circular transition. Sustainability **13**(22), 12351 (2021)
- Nußholz, J.L.K.: A circular business model mapping tool for creating value from prolonged product lifetime and closed material loops. J. Clean. Prod. **197**, 185–194 (2018). <https://doi.org/10.1016/j.jclepro.2018.06.112>
- Özçelik, A., Tollestrup, C., Lochtefeld, M.: How do longevity tools contribute on smart product design: a case study to use tools. Unpublished manuscript. Aalborg University (2022)
- Pigosso, D.C.A., Schmiegelow, A., Andersen, M.M.: Measuring the readiness of SMEs for eco-innovation and industrial symbiosis: development of a screening tool. Sustainability **10**, 2861 (2018)

- Rexfelt, O., Selvefors, A.: The use2use design tool—tools for user-centred circular design. *Sustainability* **13**(10), 1–18 (2021). <https://doi.org/10.3390/su13105397>
- Rivera-torres, P.: Is it possible to change from a linear to a circular economy? An overview of opportunities and barriers for European small and medium-sized enterprise companies (2019). <https://doi.org/10.3390/ijerph16050851>
- Roberts, D., Hughes, M.: Exploring consumers' motivations to engage in innovation through co-creation activities. *Eur. J. Mark.* **48**(1), 147–169 (2014)
- Rogers, J.G., et al.: Product longevity and shared ownership: sustainable routes to satisfying the world' s growing demand for goods. *AIMS Energy* **3**(April), 547–561 (2015)
- Sinclair, M., Sheldrick, L., Moreno, M., Dewberry, E.: Consumer intervention mapping—a tool for designing future product strategies within circular product service systems. *Sustainability* **10**(6), 2088 (2018). <https://doi.org/10.3390/su10062088>
- Schwarz, E.J., Gregori, P., Krajger, I., Wdowiak, M.A.: Entrepreneurial lean thinking for sustainable business modeling: a workshop design for incumbent firms. *Sustainabil. Manage. Forum | NachhaltigkeitsManagementForum* **29**(1), 41–55 (2021). <https://doi.org/10.1007/s00550-020-00508-y>
- Terzioğlu, N., Wever, R.: Integrating repair into product design education: insights on repair, design and sustainability. *Sustainability* **13**(18), 10067 (2021). <https://doi.org/10.3390/su131810067>
- Verganti, R.: Radical design and technology epiphanies: a new focus for research on design management. *J. Prod. Innov. Manag.* **28**(3), 384–388 (2011)
- Wallner, T.S., Magnier, L., Mugge, R.: An exploration of the value of timeless design styles for the consumer acceptance of refurbished products. *Sustainability* **12**(3), 1213 (2020)
- Wastling, T., Charnley, F., Moreno, M.: Design for circular behaviour: considering users in a circular economy. *Sustainability* **10**(6), 1743 (2018). <https://doi.org/10.3390/su10061743>
- Whalen, K.: Risk & race: creation of a finance-focused circular economy serious game. PLATE (Product Lifetimes and the Environment) Conference, Delft University of Technology 8–10 November 2017, 4 (2017)
- Whalen, K.A., Berlin, C., Ekberg, J., Barletta, I., Hammersberg, P.: 'All they do is win': lessons learned from use of a serious game for circular economy education. *Resour. Conserv. Recycl.* **135**, 335–345 (2018). <https://doi.org/10.1016/j.resconrec.2017.06.021>
- Yang, M., Smart, P., Kumar, M., Jolly, M., Evans, S.: The management of operations product-service systems business models for circular supply chains. *Prod. Plann. Control* **7287**, 1–11 (2018). <https://doi.org/10.1080/09537287.2018.1449247>

**Open Access** This chapter is licensed under the terms of the Creative Commons Attribution 4.0 International License (<http://creativecommons.org/licenses/by/4.0/>), which permits use, sharing, adaptation, distribution and reproduction in any medium or format, as long as you give appropriate credit to the original author(s) and the source, provide a link to the Creative Commons license and indicate if changes were made.

The images or other third party material in this chapter are included in the chapter's Creative Commons license, unless indicated otherwise in a credit line to the material. If material is not included in the chapter's Creative Commons license and your intended use is not permitted by statutory regulation or exceeds the permitted use, you will need to obtain permission directly from the copyright holder.





# A Fuzzy Sustainable Quality Function Deployment Approach to Design for Disassembly with Industry 4.0 Technologies Enablers

Samira Keivanpour<sup>(✉)</sup>

Mathematics and Industrial Engineering Department, Polytechnique Montreal, Montreal, QC,  
Canada

samira.keivanpour@polymtl.ca

**Abstract.** Integrating sustainability into product design is a proactive circular economy practice and design for disassembly is an essential eco-design practice for complex product manufacturers. Today, industry 4.0 technologies have considerable influence on product life cycle management, and a few studies address the contributions of these technologies to eco-design methods. Designing the appropriate eco-design tool is challenging considering the complexity of products, organizational instruments, the need for integrating diverse databases, customization of the tool, and incorporating the strategic goals. Hence, a systematic approach is required to address the implications of innovative technologies and integrate the different technical, economic, environmental, and social aspects into the design stage. Quality function deployment (QFD) is an effective approach to integrating customers, technical, and business requirements into new product development. Fuzzy Sustainable QFD is an extended version of this method for considering three pillars of sustainability in design and dealing with qualitative linguistic judgments. This paper proposes a Fuzzy sustainable QFD approach to design for disassembly. A numerical example illustrates the application of the proposed method.

**Keywords:** Fuzzy Sustainable QFD · Industry 4.0 · Design for disassembly (DfD) · Decision support tool

## 1 Introduction

Developing an effective decision tool for DfD is essential considering several features including integrating different product databases, the results of the life cycle and life cost analysis, facilitating the work of designers with visualization capacity, and multivariate analysis [1, 20]. The contemporary trends in DfD are improving disassembly conditions by using advanced technologies, automation by robots, standardization of the process, waste elimination, and incorporation of human factors. This study aims to develop a sustainability tool for benchmarking the application of recent technologies in disassembly based on design features. A fuzzy sustainable QFD approach is developed to consider the ease of disassembly, disassembly performance as well as sustainability criteria to assess Industry 4.0-driven disassembly. The rest of the paper is organized as follows: Sect. 2

provides a literature review, and the proposed model is discussed in Sect. 3. Section 4 provides a numerical example and finally, Sect. 5 concludes with some remarks.

## 2 Literature Review

In this section, a brief review of factors affecting the disassembly process, innovative technologies, and applications of the fuzzy QFD approach is provided.

### 2.1 Design for Disassembly

Crowther [2] discussed the core elements of DfD including the life cycle steps (planning, design, manufacturing/construction, operations, and decommissioning), strategies (reusing, recycling, quality, and reducing hazardous material), and resource impacts (material, energy, land, and water impacts). The principles and best practices for DfD include reducing hazardous material, reducing the complexity, number of components, and material mix, reducing connection and fasteners, and facilitating the logistics of disassembly operations [2]. Bogue [3] also discussed the importance of DfD and its principles. The author discussed that three principles including material selection, component design, architecture, and the fasteners design should be considered [3]. The author concluded that DfD is not only for regulatory compliance but also can enhance the efficiency and the products' environmental performance. Fadhilah Arisya and Suryantini [4] discussed the great advantages of modularity design in sustainability and circular architecture. Cheng et al. [5] discussed DfD in electric rice cooker. They mentioned five influential factors in DfD including material, structure, joints /connection, characteristics of the parts, and disassembly conditions. Soh et al. [6] discussed the challenges of DfD based on technology, methodology, and human factors. The authors explained that despite optimizing the sequence planning, the operators may face difficulties in accessing the parts and fasteners [6]. For the human factors, the authors explained the importance of ergonomic and safety factors. Cappelli et al. [7] developed an optimization model for sequence planning in disassembly. The authors used an algorithm in a Computer-Aided Design (CAD) environment for considering the complexity of the number of parts and the relationship between them [7]. Abuzied et al. [8] reviewed the current trends in DfD technologies and discussed the active disassembly approach. They classified the techniques into two categories. The first is a disassembly embedded design that considers facilitating the disassembly by using thermal, electrical, mechanical, or electromagnetic triggers. The second approach is active disassembly which uses smart material and structure for disassembly operations. They also discussed three essential criteria for disassembly including easy demanufacturing, reducing time for operation, and increasing the material and components recovery rate [8].

### 2.2 Industry 4.0 and Design for Disassembly

Recently scholars focused on the application of advanced technologies and industry 4.0 in DfD. For example, Freddi and Frizziero [9] discussed the advantages of Augmented Reality (AR) in the disassembly of parts during maintenance tasks. They explained that

visualization of the product can aid in maintenance operations and enhance safety features. The collaborative technologies can facilitate visualization of the virtual component in relative spatial position for further assessment [9]. Frizziero et al. [10] developed an optimization model for sequence planning of disassembly operations for a gearbox and then they used AR for demonstrating of 3D model of the sequences to facilitate the tasks for operators. AR can facilitate understanding the real dimension of the parts and components and aid in real disassembly operations [10]. Chang et al. [11] provided a review of the methods and the challenges for product disassembly. They explained that Virtual Reality (VR) and AR technology are promising in DfD as the techniques such as design for modularity and reducing the number of fasteners could be visualized and assessed with these technologies. Furthermore, AR-guided disassembly operation can reduce the operation time and aid manual disassembly [11]. Kerin and Pham [12] conducted a systematic review of applications of Industry 4.0 technologies in remanufacturing. They mentioned AR/VR as a new trend in remanufacturing. However, in terms of application and designing the decision tools, it is at an infancy stage [12]. Keivanpour [1] developed a conceptual framework for the application of Industry 4.0 in DfD. The author mentioned four elements for this model: value-driven approach, visualization and enhancing the design environment, co-creation design, and use of artificial intelligence techniques such as machine learning and fuzzy logic) in optimizing the operational tasks. The combination of 3D animation modeling of parts, CAD data, and VR/AR can improve DfD [1, 19]. Collaborative robots are also current trends in the application of Industry 4.0 in disassembly. Huang et al. [13] discussed the application of cobots in the disassembly of repetitive, heavy, and dangerous operational tasks. Moreover, it is a more cost-efficient solution than an automated disassembly. Felder et al. [14] also discussed the advantages of collaborative robots in the flexibility of disassembly cells and cost reduction.

### 2.3 Fuzzy Quality Function Deployment

Bevilacqua et al. [15] developed a fuzzy QFD approach for supplier selection. The authors used fuzzy numbers to consider the linguistic variables and the relative importance of the criteria in ranking the suppliers. Bottani and Rizzi [16] developed a fuzzy QFD approach to logistics service management. The fuzzy number is used to deal with the qualitative linguistic judgment of the decision-makers. Yang et al. [17] developed a fuzzy QFD approach to design for remanufacturing. They used the case of car remanufacturing for demonstrating the proposed approach. They considered the technical and environmental criteria in the proposed QFD model. The synthesis of the literature review highlights the following points:

- The human factors and technological advancement should be integrated into designing the decision tool for DfD.
- Integrating three pillars of sustainability in QFD in developing the DfD tool is fresh. Romli et al. [18] integrated life cycle assessment into the QFD approach for eco-design decision-making. However, the social criteria have not received much attention in the literature.

- Fuzzy sustainable QFD is an effective approach to considering the implication of Industry 4.0 technology at the design stages, uncertainties in linguistics judgment of decision-makers, and integration of environmental, social, and economic factors.

### 3 Proposed Model

QFD is a quality management tool for integrating the customers’ requirements and products’ technical characteristics into the design stage. It includes customers’ requirements features, the relevance of these features, and the product characteristics. It also comprises the correlations of the technical criteria, the relation matrix that address the relationship between customers’ attributes and technical factors, and the weights and final scores for comparing the design options based on technical and customers’ requirements. A sustainable fuzzy QFD approach is an extending version of QfD for integrating sustainability attributes and considering uncertainties and inaccuracies of decision makers’ opinions. The proposed conceptual framework and the method are presented in Fig. 1. For the sustainability attributes of disassembly, ease of disassembly, operation performance, and environmental and social performance are considered. The technical criteria include the technical features of the product and the environmental and social impacts. The comparative analysis includes benchmarking between the technological options, calculating the score of options, the relative weights, and the final relative score. There are different fuzzy numbers. In this study, triangular fuzzy numbers for addressing correlations among attributes and the importance of factors are used. For weak relationships,  $\tilde{f}(1, 2, 3)$ , medium  $\tilde{f}(4, 5, 6)$ , and strong  $\tilde{f}(7,8,9)$  are considered. The linguistic variable of fuzzy number  $\tilde{f}(7,8,9)$  means the evaluation is between 7 and 9, with the maximum degree of membership 8. Multiplication of the elements of the relationship matrix and sustainability attributes gives the score for each column and the relative importance can be calculated based on dividing the score of each column by the total of scores. Equations 1 and 2 show the score of each column ( $S$ ) and the relative scores ( $RS$ ). Where  $f$  is the relational strength and  $w$  is the weight of sustainability attributes. The fuzzy operations are provided in Eqs. 3–6. An example of triangular fuzzy numbers and operations is provided in Fig. 2.

$$\tilde{S}_j = \sum_{i=1}^n (\tilde{f}_i \times \tilde{w}_{j,i}) \forall i, j \tag{1}$$

$$\tilde{RS}_j = \frac{\tilde{S}_j}{\sum_{j=1}^J \tilde{S}_j} \quad \forall j \tag{2}$$

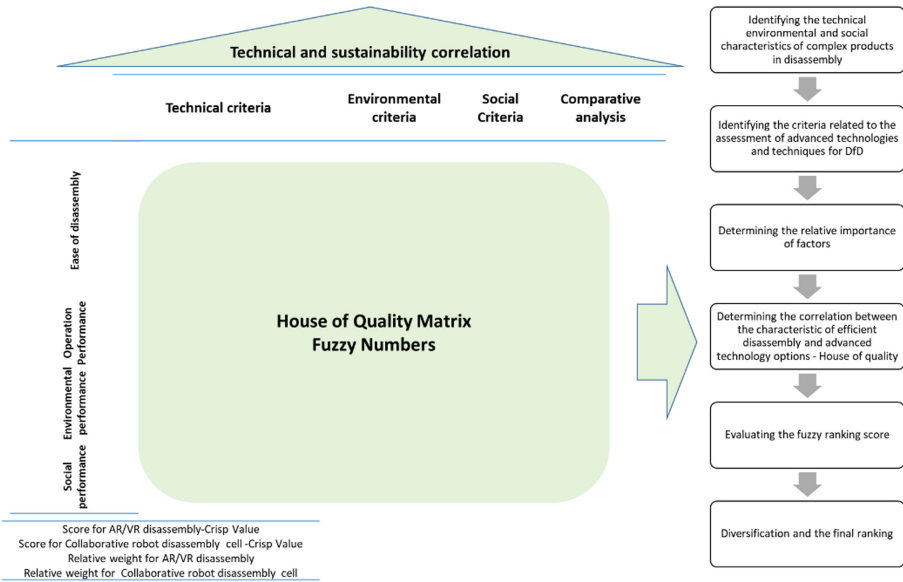
$$\forall \tilde{A} = (a_1 \ a_2 \ a_3), \tilde{B} = (b_1 \ b_2 \ b_3)$$

$$\tilde{A} + \tilde{B} = (a_1 + b_1 \ a_2 + b_2 \ a_3 + b_3) \tag{3}$$

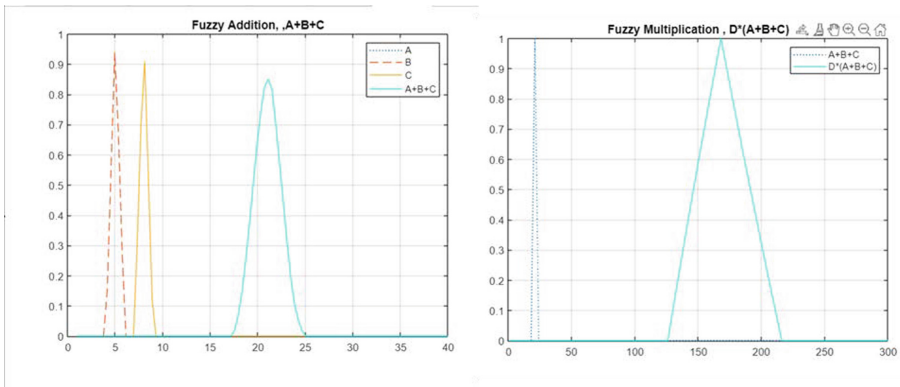
$$\tilde{A} - \tilde{B} = (a_1 - b_1 \ a_2 - b_2 \ a_3 - b_3) \tag{4}$$

$$\tilde{A} \times \tilde{B} = [\min(a_1b_1, a_1b_3, a_3b_1, a_3b_3), a_2b_2, \max(a_1b_1, a_1b_3, a_3b_1, a_3b_3)] \tag{5}$$

$$\tilde{A}/\tilde{B} = [\min(a_1/b_1, a_1/b_3, a_3/b_1, a_3/b_3), a_2b_2, \max(a_1/b_1, a_1/b_3, a_3/b_1, a_3/b_3)] \tag{6}$$



**Fig. 1.** Sustainable fuzzy QFD approach to benchmarking Industry 4.0 driven DfD



**Fig. 2.** Example of linguistic variables and the fuzzy operations (left addition, right, multiplication)-  $A = \text{trimf}(x, [7 \ 8 \ 9])$ ;  $B = \text{trimf}(x, [4 \ 5 \ 6])$ ;  $C = \text{trimf}(x, [7 \ 8 \ 9])$ ;  $D = \text{trimf}(x, [7 \ 8 \ 9])$ ; trimf: Triangular membership function- (y: degree of membership)



## 4 A Numerical Example

In this part, a numerical example of the application of the proposed approach for DfD of a complex product is provided. The first step is identifying the technical, environmental, and social characteristics of the complex products for disassembly operation. The influential factors for DfD based on the literature review and secondary data are considered. Strength, positioning, weight, shape, size, operating time, material connection, structure, mating face, number of parts, commonality of parts, and modularity design are critical technical features that affect the ease of disassembly. Three environmental impacts including energy usage, waste, material usage, and three social criteria stress, fatigue, and the risk of injury during disassembly operation are also considered. Benchmarking of two advanced technologies in disassembly {AR/VR guided disassembly} and {collaborative robot disassembly cell} are considered. The next step is identifying the criteria related to the assessment of advanced technologies and techniques for DfD based on four categories of performance. Reliability of recovered parts, acceptable value/cost ratio, time for preparation, disassembly time, ease of access to parts and fixation points, fastener positioning, easy movement, and material handling, required tools, and training are the attributes for easy disassembly. Low costs and the part recovery rate are also considered as operational performance attributes. For environmental performance, less material usage, circularity, and less waste during the operations are selected. In human factors, reducing ergonomic and safety risks, as well as increasing operators' motivation, are addressed. The correlation between the characteristics of efficient disassembly and advanced technology options should be determined. Evaluating the fuzzy ranking score and finally, defuzzification based on the centroid method is performed. The decision tool is coded in MATLAB and the results are shown in Table 1.

## 5 Conclusion

QFD approach is a robust design tool for linking the customers' attributes to technical features of the products and performing the competitive analysis. In addition to the technical features of the products, the environmental and social features could be integrated into this tool to provide a holistic decisional method. Moreover, considering the uncertainties and inaccuracies of the linguistics variables, fuzzy logic could be included. This paper proposed a sustainable fuzzy QFD decisional tool for DfD of a complex product for benchmarking the application of different Industry 4.0 technologies in disassembly. A conceptual framework with a numerical example for comparing AR/VR guided disassembly and disassembly with cobots is provided. This model could be used for the assessment of the application of the other industry 4.0 technologies. The application of this framework with group decision-making and for a real case study is proposed for future research. Performing the sensitivity analysis for assessing the final ranking and using different fuzzy numbers with defuzzification methods are also recommended.

**Table 1.** A numerical example for applying sustainable fuzzy QFD for benchmarking AR/VR disassembly and collaborative robot disassembly cell

	Technical criteria										Environmental criteria					Social Criteria				Comparative analysis				
	Weight	Strength	Positioning	Weight	Shape	Size	Operating time	Material	Connection	Structure	Mating face	Number of parts	Commonality of parts	Modularity design	Energy usage	Material usage	Wastes	Stress	Fatigue	Injury risk	AR/VR disassembly-Crisp Value	Collaborative robot disassembly cell-Crisp Value	Relative weight for AR/VR disassembly	Relative weight for Collaborative robot disassembly cell
Ease of disassembly	Reliability of recovered parts	(7.8,9)	(7.8,9)	(7.8,9)	(4,5,6)	(7,8,9)	(6,7,8)	(6,7,8)	(6,7,8)	(6,7,8)	(6,7,8)	(6,7,8)	(6,7,8)	(6,7,8)	(6,7,8)	(6,7,8)	(6,7,8)	(6,7,8)	(6,7,8)	(6,7,8)	374.52	411.97	5.02	5.46
	Acceptable value/cost ratio	(6,7,8)	(5,6,7)	(5,6,7)	(5,6,7)	(5,6,7)	(5,6,7)	(5,6,7)	(5,6,7)	(5,6,7)	(5,6,7)	(5,6,7)	(5,6,7)	(5,6,7)	(5,6,7)	(5,6,7)	(5,6,7)	(5,6,7)	(5,6,7)	(5,6,7)	381.84	450.02	5.12	5.57
	Time for preparation	(7,8,9)	(7,8,9)	(7,8,9)	(7,8,9)	(7,8,9)	(7,8,9)	(7,8,9)	(7,8,9)	(7,8,9)	(7,8,9)	(7,8,9)	(7,8,9)	(7,8,9)	(7,8,9)	(7,8,9)	(7,8,9)	(7,8,9)	(7,8,9)	(7,8,9)	431.49	474.64	5.79	6.29
	Disassembly time	(5,6,7)	(7,8,9)	(7,8,9)	(7,8,9)	(7,8,9)	(7,8,9)	(7,8,9)	(7,8,9)	(7,8,9)	(7,8,9)	(7,8,9)	(7,8,9)	(7,8,9)	(7,8,9)	(7,8,9)	(7,8,9)	(7,8,9)	(7,8,9)	(7,8,9)	356.60	320.94	4.78	4.25
	Ease of access to parts	(4,5,6)	(7,8,9)	(7,8,9)	(7,8,9)	(7,8,9)	(7,8,9)	(7,8,9)	(7,8,9)	(7,8,9)	(7,8,9)	(7,8,9)	(7,8,9)	(7,8,9)	(7,8,9)	(7,8,9)	(7,8,9)	(7,8,9)	(7,8,9)	(7,8,9)	286.52	257.86	3.84	3.42
	Access to fixation points	(6,7,8)	(7,8,9)	(7,8,9)	(7,8,9)	(7,8,9)	(7,8,9)	(7,8,9)	(7,8,9)	(7,8,9)	(7,8,9)	(7,8,9)	(7,8,9)	(7,8,9)	(7,8,9)	(7,8,9)	(7,8,9)	(7,8,9)	(7,8,9)	(7,8,9)	388.99	327.09	4.95	4.40
	Passengers positioning	(4,5,6)	(7,8,9)	(7,8,9)	(7,8,9)	(7,8,9)	(7,8,9)	(7,8,9)	(7,8,9)	(7,8,9)	(7,8,9)	(7,8,9)	(7,8,9)	(7,8,9)	(7,8,9)	(7,8,9)	(7,8,9)	(7,8,9)	(7,8,9)	(7,8,9)	302.03	285.72	4.05	3.46
	Easy movement	(5,6,7)	(7,8,9)	(7,8,9)	(7,8,9)	(7,8,9)	(7,8,9)	(7,8,9)	(7,8,9)	(7,8,9)	(7,8,9)	(7,8,9)	(7,8,9)	(7,8,9)	(7,8,9)	(7,8,9)	(7,8,9)	(7,8,9)	(7,8,9)	(7,8,9)	406.58	456.82	5.64	5.38
	Easy material handling	(6,7,8)	(6,7,8)	(6,7,8)	(6,7,8)	(6,7,8)	(6,7,8)	(6,7,8)	(6,7,8)	(6,7,8)	(6,7,8)	(6,7,8)	(6,7,8)	(6,7,8)	(6,7,8)	(6,7,8)	(6,7,8)	(6,7,8)	(6,7,8)	(6,7,8)	352.12	393.55	4.79	4.02
	Required tools	(5,6,7)	(6,7,8)	(6,7,8)	(6,7,8)	(6,7,8)	(6,7,8)	(6,7,8)	(6,7,8)	(6,7,8)	(6,7,8)	(6,7,8)	(6,7,8)	(6,7,8)	(6,7,8)	(6,7,8)	(6,7,8)	(6,7,8)	(6,7,8)	(6,7,8)	439.75	339.81	5.90	4.37
Required training	(7,8,9)	(7,8,9)	(7,8,9)	(7,8,9)	(7,8,9)	(7,8,9)	(7,8,9)	(7,8,9)	(7,8,9)	(7,8,9)	(7,8,9)	(7,8,9)	(7,8,9)	(7,8,9)	(7,8,9)	(7,8,9)	(7,8,9)	(7,8,9)	(7,8,9)					
Costs																								
Part recovery rate																								
Performance	Less Material usage	(7,8,9)	(7,8,9)	(7,8,9)	(7,8,9)	(7,8,9)	(7,8,9)	(7,8,9)	(7,8,9)	(7,8,9)	(7,8,9)	(7,8,9)	(7,8,9)	(7,8,9)	(7,8,9)	(7,8,9)	(7,8,9)	(7,8,9)	(7,8,9)	(7,8,9)	419.53	482.45	5.63	6.39
	Circularity	(5,6,7)	(7,8,9)	(7,8,9)	(7,8,9)	(7,8,9)	(7,8,9)	(7,8,9)	(7,8,9)	(7,8,9)	(7,8,9)	(7,8,9)	(7,8,9)	(7,8,9)	(7,8,9)	(7,8,9)	(7,8,9)	(7,8,9)	(7,8,9)	(7,8,9)	367.15	367.15	4.93	4.87
	Less energy consumption	(6,7,8)	(7,8,9)	(7,8,9)	(7,8,9)	(7,8,9)	(7,8,9)	(7,8,9)	(7,8,9)	(7,8,9)	(7,8,9)	(7,8,9)	(7,8,9)	(7,8,9)	(7,8,9)	(7,8,9)	(7,8,9)	(7,8,9)	(7,8,9)	(7,8,9)	367.36	367.36	4.93	4.87
Environment	Less wastes	(6,7,8)	(7,8,9)	(7,8,9)	(7,8,9)	(7,8,9)	(7,8,9)	(7,8,9)	(7,8,9)	(7,8,9)	(7,8,9)	(7,8,9)	(7,8,9)	(7,8,9)	(7,8,9)	(7,8,9)	(7,8,9)	(7,8,9)	(7,8,9)	(7,8,9)	367.68	294.15	4.93	3.90
	Less ergonomic risks	(7,8,9)	(6,7,8)	(7,8,9)	(7,8,9)	(7,8,9)	(7,8,9)	(7,8,9)	(7,8,9)	(7,8,9)	(7,8,9)	(7,8,9)	(7,8,9)	(7,8,9)	(7,8,9)	(7,8,9)	(7,8,9)	(7,8,9)	(7,8,9)	(7,8,9)	353.49	388.84	4.74	5.15
	Less safety risks	(7,8,9)	(6,7,8)	(7,8,9)	(7,8,9)	(7,8,9)	(7,8,9)	(7,8,9)	(7,8,9)	(7,8,9)	(7,8,9)	(7,8,9)	(7,8,9)	(7,8,9)	(7,8,9)	(7,8,9)	(7,8,9)	(7,8,9)	(7,8,9)	(7,8,9)	419.00	502.80	5.62	6.66
Social	Operators' motivation	(7,8,9)	(6,7,8)	(7,8,9)	(7,8,9)	(7,8,9)	(7,8,9)	(7,8,9)	(7,8,9)	(7,8,9)	(7,8,9)	(7,8,9)	(7,8,9)	(7,8,9)	(7,8,9)	(7,8,9)	(7,8,9)	(7,8,9)	(7,8,9)	(7,8,9)	364.76	437.71	4.89	5.80
Performance	Score for AR/VR disassembly-Crisp Value	(5,6,7)	(5,6,7)	(5,6,7)	(5,6,7)	(5,6,7)	(5,6,7)	(5,6,7)	(5,6,7)	(5,6,7)	(5,6,7)	(5,6,7)	(5,6,7)	(5,6,7)	(5,6,7)	(5,6,7)	(5,6,7)	(5,6,7)	(5,6,7)	(5,6,7)	360.71	432.86	4.84	5.74
	Score for Collaborative robot disassembly cell-Crisp Value	3.50	3.00	3.11	3.76	3.50	3.63	3.76	3.76	3.66	3.66	3.66	3.66	3.66	3.66	3.66	3.66	3.66	3.66	3.66	3.66	3.66	3.66	3.66
Relative weight for AR/VR disassembly		0.04	5.58	5.58	5.58	5.62	5.41	5.92	5.38	6.09	5.21	5.74	5.93	5.71	6.12	5.19	5.93	5.19	5.93	5.19	5.46	5.46	5.46	5.46
	Relative weight for Collaborative robot disassembly cell	0.04	4.89	4.50	5.40	5.46	6.15	5.75	5.12	5.92	5.06	6.13	6.22	6.10	5.94	5.04	5.37	4.28	5.84	4.77	4.28	5.84	4.77	

## References

1. Keivanpour, S.: Perspectives of applications of industry 4.0-enabled eco-design in the aircraft industry. In: *Approaches, Opportunities, and Challenges for Eco-design 4.0*, pp. 67–88. Springer, Cham (2022). [https://doi.org/10.1007/978-3-030-87371-4\\_5](https://doi.org/10.1007/978-3-030-87371-4_5)
2. Crowther, P.: Design for disassembly—themes and principles. *Environ. Des. Guide*, 1–7 (2005)
3. Bogue, R.: Design for disassembly: a critical twenty-first century discipline. *Assembly Autom.* **27**(4), 285–289 (2007). <https://doi.org/10.1108/01445150710827069>
4. Fadhilah Arisya, K., Suryantini, R.: Modularity in Design for Disassembly (DfD): Exploring the Strategy for a Better Sustainable Architecture. In *IOP Conference Series: Earth Environ. Sci.* **738**(1), 012024 (2021)
5. Cheng, S.M., Mamat, T.N.A.R.: Design for disassembly in electric rice cooker manufacturing. *Progr. Eng. Appl. Technol.* **2**(1), 731–742 (2021)
6. Soh, S.L., Ong, S.K., Nee, A.Y.C.: Design for disassembly for remanufacturing: methodology and technology. *Proc. CIRP* **15**, 407–412 (2014)
7. Cappelli, F., Delogu, M., Pierini, M., Schiavone, F.: Design for disassembly: a methodology for identifying the optimal disassembly sequence. *J. Eng. Des.* **18**(6), 563–575 (2007)
8. Abuzied, H., Senbel, H., Awad, M., Abbas, A.: A review of advances in design for disassembly with active disassembly applications. *Eng. Sci. Technol. Int. J.* **23**(3), 618–624 (2020)
9. Freddi, M., SFrizziero, L.: Design for disassembly and augmented reality applied to a tailstock. *Actuators* **9**(4), 102 (2020). <https://doi.org/10.3390/act9040102>
10. Frizziero, L., Liverani, A., Caligiana, G., Donnici, G., Chinaglia, L.: Design for disassembly (DfD) and augmented reality (AR): Case study applied to a gearbox. *Machines* **7**(2), 29 (2019)
11. Chang, M.M.L., Ong, S.K., Nee, A.Y.C.: Approaches and challenges in product disassembly planning for sustainability. *Proc. CIRP* **60**, 506–511 (2017)
12. Kerin, M., Pham, D.T.: A review of emerging industry 4.0 technologies in remanufacturing. *J. Clean. Prod.* **237**, 117805 (2019)
13. Huang, J., et al.: A strategy for human-robot collaboration in taking products apart for remanufacture. *FME Trans.* **47**(4), 731–738 (2019)
14. Felder, B. (2019). Programming of Collaborative Robot (Cobot) to Selectively Disassemble Products to Obtain Critical Materials
15. Bevilacqua, M., Ciarapica, F.E., Giacchetta, G.: A fuzzy-QFD approach to supplier selection. *J. Purch. Supply Manag.* **12**(1), 14–27 (2006)
16. Bottani, E., Rizzi, A.: Strategic management of logistics service: a fuzzy QFD approach. *Int. J. Prod. Econ.* **103**(2), 585–599 (2006)
17. Shanshan Yang, S.K., Ong, A.Y.C.: Design for remanufacturing - a fuzzy-QFD approach. In: Nee, A.Y.C., Song, B., Ong, S.-K. (eds.) *Re-engineering Manufacturing for Sustainability: Proceedings of the 20th CIRP International Conference on Life Cycle Engineering*, Singapore 17-19 April, 2013, pp. 655–661. Springer Singapore, Singapore (2013). [https://doi.org/10.1007/978-981-4451-48-2\\_107](https://doi.org/10.1007/978-981-4451-48-2_107)
18. Romli, A., Prickett, P., Setchi, R., Soe, S.: Integrated eco-design decision-making for sustainable product development. *Int. J. Prod. Res.* **53**(2), 549–571 (2015)
19. Keivanpour, S.: Toward joint application of fuzzy systems and augmented reality in aircraft disassembly. In: Kahraman, C., Aydın, S. (eds.) *Intelligent and Fuzzy Techniques in Aviation 4.0*. SSDC, vol. 372, pp. 265–280. Springer, Cham (2022). [https://doi.org/10.1007/978-3-030-75067-1\\_11](https://doi.org/10.1007/978-3-030-75067-1_11)
20. Keivanpour, S., Ait Kadi, D.: Strategic eco-design map of the complex products: toward visualization of the design for environment. *Int. J. Prod. Res.* **56**(24), 7296–7312 (2018)

**Open Access** This chapter is licensed under the terms of the Creative Commons Attribution 4.0 International License (<http://creativecommons.org/licenses/by/4.0/>), which permits use, sharing, adaptation, distribution and reproduction in any medium or format, as long as you give appropriate credit to the original author(s) and the source, provide a link to the Creative Commons license and indicate if changes were made.

The images or other third party material in this chapter are included in the chapter's Creative Commons license, unless indicated otherwise in a credit line to the material. If material is not included in the chapter's Creative Commons license and your intended use is not permitted by statutory regulation or exceeds the permitted use, you will need to obtain permission directly from the copyright holder.





# Identification of Product Specifications Based on KANO Model and Application to Ecodesign

Nozomu Mishimar<sup>(✉)</sup>

Akita University, Tegatagakuen-Machi, Akita-Shi, Akita 0108502, Japan  
nmishima@gipc.akita-u.ac.jp

**Abstract.** It is said that KANO model is one of the key findings in analyzing and categorizing various product qualities. The model says qualities are not only one dimensional in terms of the relations between quality fulfilment and customer satisfaction. If a designer could find a delighter which can increase customer satisfaction greatly without enhancing specification too much may contribute to increase product eco-efficiency, since higher specifications usually lead to larger environmental burden. The study extracts some design specifications of smartphones and carries out an online survey to smartphone users in order to identify the relations between the specification levels and customer satisfaction levels. As the result of the survey, a true exciter could not be found in the case study products. However, regression coefficients estimated by applying conjoint analysis to the selected specifications showed there were specifications which can effectively increase customer satisfaction such as battery capacity or display size, and also there was a specification having little effect in increasing it. The survey results suggested that there are optimum values of product specifications. Identifying the optimum values and avoiding over-specification is significant in finding appropriate design solutions which may decouple the customer satisfaction and the environmental burden increase. The study concluded that the approach is helpful in enhancing product sustainability by Ecodesign.

**Keywords:** KANO model · Product specifications · Eco-efficiency

## 1 Introduction

In designing industrial products, designers are trying to enhance the performance of the product as much as they can, under some balance with production cost. And of course, the reason to build-in high functionalities in the products is to fulfill customer requirements and enhance product attractiveness. For smartphones, it seems that the overall product performance has increased steadily over the years [1]. It means that the designers have focused and the consumers have required such increase of the specifications.

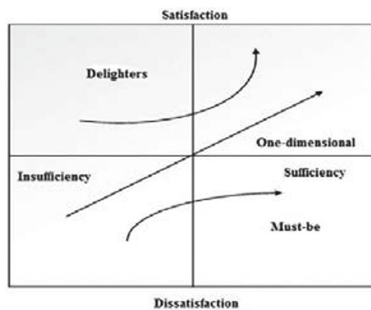
KANO model [2] made an important suggestion on this tendency. The model said product qualities are not always linear to customer satisfaction. The model explains that there are 3 major types of quality attributes and by focusing on the so-called “delighters,” customer satisfaction levels can be increased efficiently. But even for low-cost products,

so-called “must-bes” qualities should not be eliminated. Some previous studies [3–6] have focused in applying the concept to environmentally benign design. By focusing on delighters, it might be possible to increase product attractiveness without enhancing product performance greatly that requires extra environmental burden.

However, it is not always possible to find delighters in real products, especially for matured products/markets, since people soon start to think they are must-bes, once it is build-in commercial products. The author surveyed weights of design specifications and estimated eco-efficiencies of the design specifications in a previous study [7], and explained that it is possible to enhance product eco-efficiency by focusing some specifications. The author notified customer’s voice such as “this specification is important, but I am satisfied at the current level.” This was an important suggestion to think that must-bes can be found and the bending points of the curves can be specified. Since the enhancement of product performances require certain amounts of environmental burdens, it is not eco-efficient to increase the performance beyond these points. Thus, the objective of this study is to clarify the design specifications of the case study product are delighters, one-dimensional or must-bes, and whether there is a bending point in each specification, by a customer survey. Through this effort, the study can clarify the optimum levels of design specifications, in the context of eco-design.

## 2 Why KANO Model

The simplified KANO model in three different quality attributes can be expressed as Fig. 1 [8]. The figure clearly shows that if we can find the bending point of the mut-be curve, it will greatly contribute in eco-efficient design. If there is no drastic change of manufacturing technologies and the environmental burden to increase the design specification level is proportional to the increase amount like memory capacity, eco-efficiencies of design specifications defined by Eq. (1) will peak at the bending point of the must-be. At the same time, it will be the same for one-dimensional and will continuously increase for delighters. But even for a one-dimensional, a bending point can be found. Finding the bending points will be helpful to extract suggestions in designing eco-efficient products. That was the motivation of the study and the reason to carry out a customer survey to know customer’s preference on design specifications.



**Fig. 1.** Simplified KANO model [7]

$$\text{Eco-efficiency} = \frac{\text{Increase of the customer satisfaction level}}{\text{Increase of the environmental burden}} [\text{kg} - \text{CO}_2 - 1] \quad (1)$$

### 3 Internet Survey of Customer Satisfaction

#### 3.1 Target Product Specifications

In choosing the case study example as a smartphone, some design specifications to investigate customer preference were selected as below. Four different specification levels were set for each specification.

- Battery capacity
- Storage capacity
- Display size
- Variations of smartphone case
- Price

The first three specifications are the top three functions listed to be important functions for smartphones in the preliminary survey. “Variations of smartphone case” was found to be relatively important among the three features related to outlook of the product, those were color, texture and variations of smartphone case, investigated in the previous study. The last one, price, was designated because it is helpful to know the willingness to pay of other specification by comparing to the preference to price. It is also possible to check the accuracy of survey by calculating the customer preference for the different levels of price, since the reactions to different prices are thought to be linear to the price itself. This is the background of the pricing system which can be seen in the reverse linear relationship between price and demand in basic economics theory.

#### 3.2 Outline of the Customer Survey

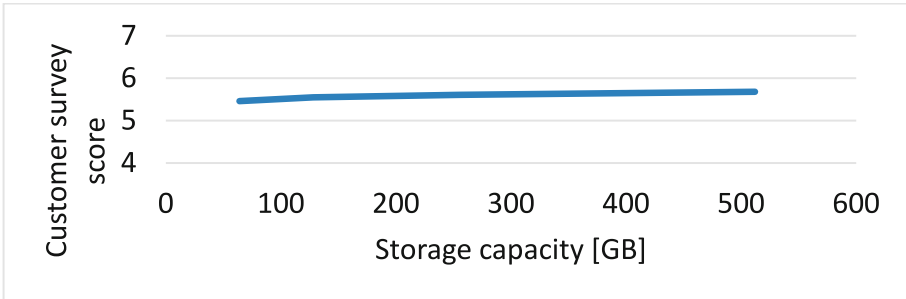
Table 1 shows the four different specification levels of five design specifications of smartphones. The four specification levels were determined based on the actual values in the current smartphone market. The customer survey was designed based on conjoint analysis method [9]. Assuming that there are no interactions between the five specifications, L16 orthogonal array which can be used for five attributes and four levels was used to design the conjoint cards. Each card was evaluated with full score of 10. The survey was made to 230 respondents via internet.

#### 3.3 Results of the Survey

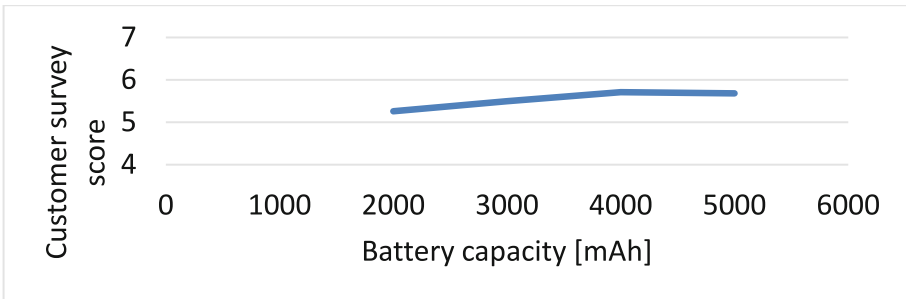
The result of the customer survey shown in the previous section for five design specifications are indicated in Fig. 2 to Fig. 6 below.

**Table 1.** Four levels of five design specifications

Storage capacity [GB]	Battery capacity [mAh]	Display size [inch]	Variations of smartphone case	Price [JPY]
64	2,000	3.8	10	130,000
128	3,000	4.8	50	100,000
256	4,000	5.8	90	70,000
512	5,000	6.8	130	40,000



**Fig. 2.** Relation between storage capacity and customer satisfaction



**Fig. 3.** Relation between battery capacity and customer satisfaction



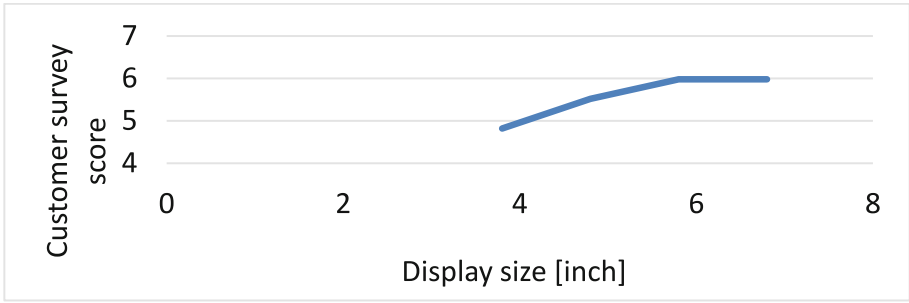


Fig. 4. Relation between display size and customer satisfaction

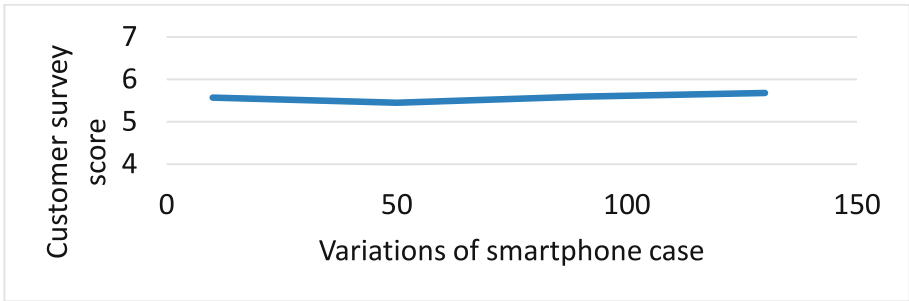


Fig. 5. Relation between variations of smartphone cases and customer satisfaction

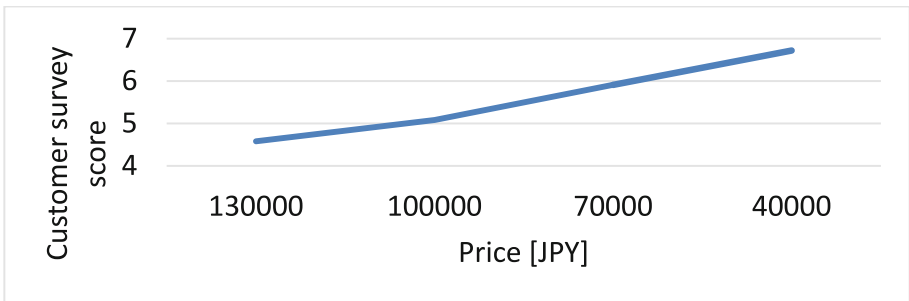


Fig. 6. Relation between price and customer satisfaction

## 4 Estimation of Eco-efficiencies

### 4.1 Estimation of Environmental Burden

Since the customer satisfaction levels corresponding to the different specification levels were estimated through the customer survey, the numerator of eco-efficiency equation has been identified. In order to identify the denominator, environmental burden to increase design specifications were investigated and extrapolated through previous studies [10,

11]. Table 2 shows the environmental burden increase quantified by CO<sub>2</sub> emission corresponding to the increase of three design specifications except for variations of case and price.

As for the increase of variations of smartphone case, since there are molding types and one-by-one manufacturing types, increase of CO<sub>2</sub> emission per unit is not linear to the increase to the variations, since some of the variations of smartphone cases are made by molding and some are one by one manufactured. Table 3 shows the calculated values considering this. The value was calculated referring plastic parts fabrication of automobile [12]. As it was shown in Fig. 6 in the previous section, customer satisfaction increase corresponding to the price decrease is almost linear. So, it seems that the approach is reasonable. Eco-efficiencies of four design specifications were calculated.

**Table 2.** Increase of environmental burden due to performance enhancement

Design specification	CO <sub>2</sub> emission increase
Storage capacity	0.0238 [kg-CO <sub>2</sub> /GB]
Battery capacity	$4.1 \times 10^{-4}$ [kg-CO <sub>2</sub> /mAh]
Display size	0.431[kg-CO <sub>2</sub> /inch]

**Table 3.** Increase of environmental burden due to variations increase of case

Variations of case	10	50	90	130
CO <sub>2</sub> emission per unit [kg-CO <sub>2</sub> ]	0.13	0.42	0.72	1.00

### 4.2 Eco-efficiency Calculation

By using the data used in Figs. 2, 3, 4, 5 and 6 and the data shown in Table 2 and 3, it is possible to calculate eco-efficiency of performance enhancement as Tables 4, 5, 6 and 7. Figure 7 is the visual expression of these results. The figure shows that storage capacity has smaller eco-efficiency than others and some specifications have smaller speak value at the second level performances.

**Table 4.** Eco-efficiency of storage capacity increase

Performance enhancement	Eco-efficiency [1/kg-CO <sub>2</sub> ]
64 GB–128 GB	0.061
128 GB–256 GB	0.020
256 GB–512 GB	0.012

**Table 5.** Eco-efficiency of battery capacity increase

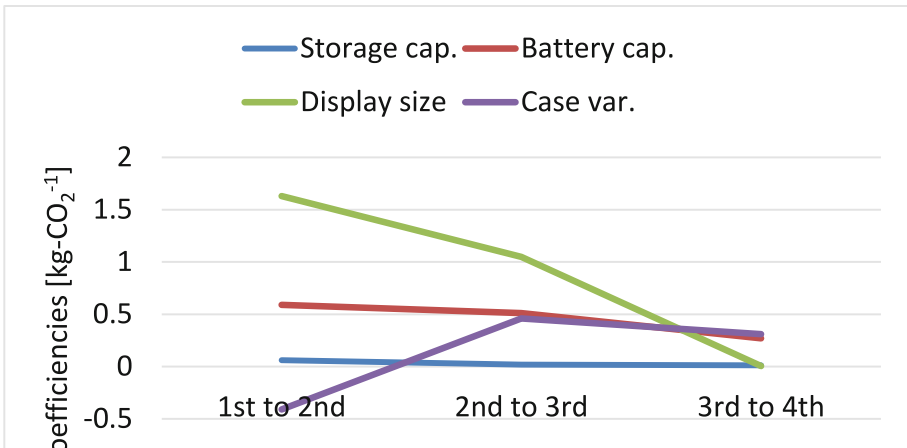
Performance enhancement	Eco-efficiency [1/kg-CO <sub>2</sub> ]
2,000–3,000 mAh	0.59
3,000–4,000 mAh	0.51
4,000–5,000 mAh	0.27

**Table 6.** Eco-efficiency of display size increase

Performance enhancement	Eco-efficiency [1/kg-CO <sub>2</sub> ]
3.8–4.8 inches	1.63
4.8–5.8 inches	1.05
5.8–6.8 inches	0.005

**Table 7.** Eco-efficiency of case variation increase

Performance enhancement	Eco-efficiency [1/kg-CO <sub>2</sub> ]
10 → 50	-0.41
50 → 90	0.46
90 → 130	0.31



**Fig. 7.** Deviation of eco-efficiencies

## 5 Discussion

Considering the survey results shown in Figs. 2, 3, 4, 5 and 6, no delighter was found in the target design specifications of a smartphone. Among the four specifications except price, storage capacity seems like one-dimensional, while battery capacity and display size look like must-bes. Unlike the motivation of the study in the beginning, significance of finding bending points of the must-be curves was clarified through the study. By finding the points, it will be possible to designate the proper design specifications that are the critical points to stop the performance enhancement beyond there.

For the design specifications in the case study, it is not eco-efficient to focus on increase of storage capacity anymore, since the eco-efficiency is relatively low at all the levels. As it is shown in Fig. 7, contrarily for battery capacity and display size, since the eco-efficiency of performance enhancement is not that low, it is helpful to focus on these specifications. However, there are critical points where the performance should be stopped to increase at the point. For battery capacity, eco-efficiency is rather high till 4,000mAh. Thus, the suitable value of battery capacity can be 4,000mAh. As for the display size, since the eco-efficiency drastically decreases and is almost 0 for the increase from 5.8 inches to 6.8 inches, the optimum display size can be 5.8 inches.

This strategy to limit the product performance at a certain level is a paradigm shift for modern product design that has been aiming to enhance performance as much as possible. Although the actual values might change due to technological levels and market situations, there can be critical points of product performances that the designers should avoid to enhance them beyond the points. For a competitive and matured product, it is likely to have must-bes. Because, if someone find a delighter, it would be caught up by the competitor. Therefore, it is likely to have bending points in the performance-customer satisfaction curves.

## 6 Summary

The paper proposed a procedure to know the practical behaviors of product design specifications based on KANO model and carried out a customer survey to know that. Throughout the study, although no delighter has been found for the matured product like smartphones, the significance of must-bes, especially, finding bending points of the curves was explained in the context of eco-efficient design. Then, the paper showed a method to estimate the eco-efficiencies of specific designs, by dividing the increase of customer satisfaction levels by the increase of environmental burden to enhance product performance. Using this procedure, the paper indicated some design specifications should be focused for ecodesign of the case study. Future work is to increase the reliability of the customer survey and gather more design specifications and product examples to clarify whether such optimum design specifications can be found always.

## References

1. <https://www.androidauthority.com/smartphone-performance-improvements-timeline-626109/>

2. Kano, N., Seraku, N., Takahashi, F., Tsuji, S.: Attractive quality and must-be quality. *J. Japanese Soc. Qual. Control* **14**, 39–48 (1984)
3. Sakao, T.: Quality engineering for early stage of environmentally conscious design. In: *Proceedings of 11th QMOD Conference*, pp.50–59. Helsingborg: Sweden (2008)
4. Rasamoelina, F., Bouchard, C., Aoussat, A.: Towards a Kansei-based user modeling methodology for eco-design. *Int. J. Affect. Eng.* **12**(2), 337–348 (2013)
5. Horani, L.: Optimizing customer satisfaction by using kano's model for eco-efficiency and green design. *J. Investment Manage.* **4**(5), 285–290 (2013)
6. Dace, E., Stibe, A., Timma, L.: A holistic approach to manage environmental quality by using the Kano model and social cognitive theory. *Corp. Soc. Responsib. Environ. Manag.* **27**, 430–443 (2020)
7. Mishima, N., Kudo, T., Naito, T.: Eco-Efficiency Evaluation of Design Features Based on Value Engineering Methodology, *Transdisciplinary Engineering Methods for Social Innovation of Industry 4.0*, p.873 (2018)
8. Rotar, L., Kozar, M.: The use of the kano model to enhance customer satisfaction. *Organizacija* **50**(4), 339–351 (2017)
9. Green, P. E., Srinivasan, V.: *Conjoint analysis in consumer research*. Stanford University Research Paper, vol. 435 (1978)
10. Güvendik, M., *From Smartphone to Futurephone: assessing the environmental impacts of different circular economy scenarios of a smartphone using LCA*, Master thesis of Technical University of Delft (2014). <https://repository.tudelft.nl/islandora/object/uuid%3A13c85c95-cf75-43d2-bb61-ee8cf0acf4ff>
11. Boyd, S.B.: *Life Cycle Assessment of Semiconductors*, Ph.D. thesis in UC Berkeley. [http://digitalassets.lib.berkeley.edu/etd/ucb/text/Boyd\\_berkeley\\_0028E\\_10192.pdf](http://digitalassets.lib.berkeley.edu/etd/ucb/text/Boyd_berkeley_0028E_10192.pdf)
12. Sano, S., Tomioka, K., Ooi, Y.; LCA study of automobile recycling. *Trans. Autom. Technol. Assoc.* **49**(4), 845–848 (2018). (in Japanese)

**Open Access** This chapter is licensed under the terms of the Creative Commons Attribution 4.0 International License (<http://creativecommons.org/licenses/by/4.0/>), which permits use, sharing, adaptation, distribution and reproduction in any medium or format, as long as you give appropriate credit to the original author(s) and the source, provide a link to the Creative Commons license and indicate if changes were made.

The images or other third party material in this chapter are included in the chapter's Creative Commons license, unless indicated otherwise in a credit line to the material. If material is not included in the chapter's Creative Commons license and your intended use is not permitted by statutory regulation or exceeds the permitted use, you will need to obtain permission directly from the copyright holder.





# Concept and Implementation of a Student Design Project for the Development of Sustainable Products

Johanna Wurst<sup>(✉)</sup> , Daniel Rosemann , Iryna Mozgova ,  
and Roland Lachmayer 

Institute of Product Development, Leibniz University Hannover, An Der Universität 1,  
30823 Garbsen, Germany  
wurst@ipeg.uni-hannover.de

**Abstract.** Technology is a major driver for leveraging the potential of multidimensional sustainable development, regardless of the sector examined. Therefore, engineers have an important contribution in developing innovative technical solutions to ensure more sustainable alternatives to conventional processes or products. In order to support this comprehension from an early age on, it is the task of lecturers at universities by developing students access to sustainable engineering activities with new teaching programs. Regarding conventional product development, the question arises how sustainable products can be developed, which concepts for design and which methods for validation and quantification can be used. These and further questions are the basis of the project-based learning (PBL) approach introduced in this paper as part of a new module "Development of Sustainable Products" at the Faculty of Mechanical Engineering at the Leibniz University Hannover. In this paper, the need for new courses in the ecological sustainability context and the requirements for student project work are presented. The concept of the project and the overall objective, that the students are required to assess the ecological environmental impact of electric toothbrushes over the entire product life cycle based on a life cycle assessment (LCA) is introduced. After successfully participating in this project, students are able to conduct ecological sustainability analyses and understand the complexity within the development of sustainable products.

**Keywords:** Project-Based Learning · Life Cycle Assessment · Sustainable Product Development

## 1 Introduction

Within the conventional academic education, which includes lectures and additional tutorials, potentials regarding discussions and the personal development of the students are not fully exploited. In order to communicate the topic of product development in this context with a focus on sustainable and future-oriented products, creative ideas, approaches and impulses by the young engineers are an important input. As part of a

semester-long project, the Project-Based Learning (PBL) is to supplement the traditional learning concept based on lectures and tutorials for developing such creative ideas. The approach of PBL allows the creation of an environment in which students can both, exercise their creativity to solve technical problems independently as well as reflecting their own leadership and communication behavior within a group.

Although the related module introduces models and methods of the ecological and economic dimension, the design project focuses only on the ecological dimension of sustainability. This restriction is primarily due to the structure of the current curriculum, since although economic and social-ethical practical modules are offered. Therefore the need for a new project concerning the ecological-technical intersection is there.

Many curricula already request that their students have to deal with topics like requirements for systems and products from the economic, environmental, social, political, ethical, health and safety, manufacturability, and sustainability area [1]. This increasing call for sustainability aspects within university teaching can be explained on the one hand by the communicated goals of the government and industry as well as on the other hand by the internal university goal to integrate students early within their degree program in presence Following semesters of online learning due to the pandemic [2].

In terms of the communicated goals, for example, the Sustainable Development Goals (SDGs) may serve as a basis for moving within engineering from optional sustainable system extensions to modifications which are required to meet these goals in the future [3]. To understand how these modifications can be made, not only conventional engineering modules are needed, but rather impulses on how interdisciplinary content can be used in a supportive manner [4]. Perpignan et al. (2020) published a tabular overview of interdisciplinary and conventional engineering competencies based on interviews [4].

**Table 1.** Cross and engineers skills (cf. [5])

<b>Cross-disciplinary skills</b>	<b>Critical thinking</b>	<b>Collaboration</b>	<b>Solving a complex problem</b>	<b>Systematic thinking</b>	<b>Normative competence</b>	<b>Self-knowledge</b>	<b>Anticipatory</b>	<b>Strategic competence</b>
<b>Engineer’s skills</b>								
<b>Knowledge and understanding</b>	X		X	X				
<b>Engineering analysis</b>		X	X	X				
<b>Engineering design</b>			X					
<b>Investigations</b>	X		X		X	X		
<b>Engineering practice</b>	X		X		X			X
<b>Making judgement</b>	X							X
<b>Communication and teamworking</b>		X						
<b>Lifelong learning</b>						X		

Within the scope of this new project, which will accompany the lecture, the aim is to develop an impulse-giving addition. In this module, interdisciplinary competencies

(cf. Table 1) are to be imparted to the students through the application of project-based learning, and the sustainability of everyday products is to be examined using a concrete example. In contrast to the analysis of large systems, such as the analysis of the sustainability of the entire university activity [5], a more intensive discussion of the topic is to be achieved in smaller groups by analysing smaller systems (cf. [6]).

## 2 Project-Based Learning (PBL)

The Project-Based Learning (PBL) approach is a teaching method that focuses on the independent realization of projects to deal with issues within groups [7, 8]. Its objective is to make these groups address a complex issue over a predefined period of time, days, weeks or months, in order to both practice their existing competencies as well as expand their individual knowledge.

In order to satisfy the project nature of this approach, Thomas (2000) identified five basic characteristics of projects: Centrality, Focused Issue, Constructive Proceeding, Independence, as well as Realism [9, 10]. To implement these characteristics of a project in a teaching context, additional specific elements might be derived for student PBL [9–11]:

- Time and self management;
- Use of technological tools;
- Optimization of group-internal information management;
- Communication in groups;
- Independent project management.

The PBL can be divided into three overarching fields in which each of these elements are applied - the cognitive, the content, and the collaborative learning [11]. First, the cognitive learning outlines the issue being investigated or the way of organizing projects and associated groups adapted to these issues [10–12]. Consequently, each group has to deal individually with the overarching problem as well as the tasks and challenges associated with it [11].

In contrast, the content area includes the engagement in form of interdisciplinary learning and as such the application of theories or methods to concrete practical challenges [11, 12]. Finally, the third area of collaborative learning includes the social aspects and the relevance of goal-oriented communication within groups [10, 11].

## 3 Case Study: Design Project “Sustainable Products”

As part of the present trend of sustainability efforts, the Faculty of Mechanical Engineering at Leibniz University Hannover is offering a new bachelors degree program "Sustainable Engineering" to enable young engineers to extend the range of conventional technical approaches. The Institute of Product Development has created a new course "Development of Sustainable Products" within the area of product development. Alongside the lecture and the tutorials, students are offered a semester-long design project.



### 3.1 Structure and Content

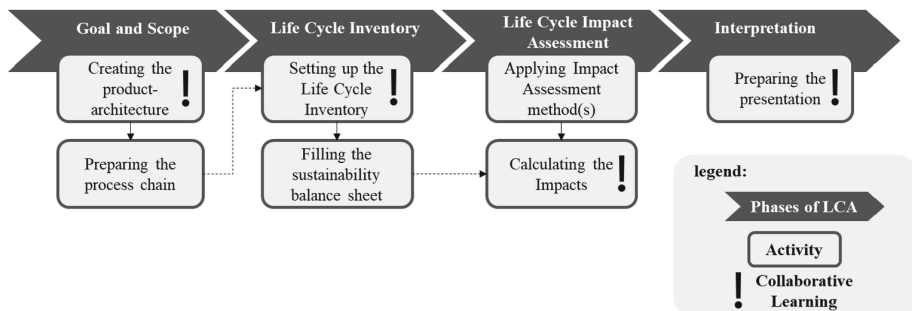
## 4 Aims and Concept

Furthermore, the students' learning potentials, especially the collaborative learning part, are to be increased by the PBL approach in the context of a concrete method, in this case life cycle assessment (LCA) according to ISO standard 14040 ff. Within this framework of LCA, the development of consciously ecologically sustainable products is pursued as an interdisciplinary component.

To be able to realize such an application in the project context, all product life cycle phases must be considered and examined in a holistic form. In addition, the students should acquire competencies in the use of sustainability accounting software through collegial learning and jointly identify potentials of sustainability for the product under investigation.

### Tasks/Module

The structure of this design project is based on the general framework of the ISO 14040ff. Series of standards [13] and is divided into three task modules according to the phases of "Goal and Scope", "Life Cycle Inventory" and "Life Cycle Impact Assessment" as well as a final presentation to demonstrate the "Interpretation" phase [14]. According to Fig. 1, each phase of the LCA can be attributed to the students' activities, which are based on one another to enable the preparation of an entire LCA. Furthermore, within the total of seven activities, collaborative learning potentials have been identified, which are to be specifically leveraged through the students' project work. These potentials are marked by exclamation marks in Fig. 1.



**Fig. 1.** Activities in the developed design project according to the phases of the life cycle assessment of ISO 14040ff. (cf. [13])

Regarding the content the first work package addresses the first and second phase of the LCA of defining the objective and the scope of the study and establishing the life cycle inventory. In this work package, students should identify the product architecture of the object of study and establish its process chain. An example of a collaborative part within the activities is the development of the products architecture during the first phase of the LCA, the "Goal and Scope". In this activity, the students collectively

investigate the demonstrator, disassemble all its components and, through internal group discussion, capture the functional as well as the product structure for the specific product example of an electric toothbrush. By combining the hands-on disassembly work and the theoretical formulation of the functional structure, the information can be linked and product-specific knowledge can emerge in the group.

During the second collaborative activity, the students shall independently investigate the life cycle inventories for the eight investigated components of the demonstrator and combine the results in a holistic model: the case, the electric motor, the electroacoustic transducer, the Printed Circuit Board (PCB), the lithium-ion battery, the charger, the travel case as well as the brush heads. As a result, the component-specific Petri nets are to be set up and modeled in Sustainability assessment tool (Umberto LCA+), with the inputs and outputs formed as a Life Cycle Inventory.

Subsequently, the students calculate the impact assessment for only one method and three impact assessment categories in order to limit the scope of the project work to a semester-compatible level. The results of these calculations are analyzed and interpreted regarding the identified results and summarized in a final, groupinternal prepared presentation.

#### **4.1 Project Results**

On the basis of these seven activities, the students combined their results in a final overall presentation. Two of the already mentioned main results with high collaborative potential are presented in the following section.

##### **Product Architecture**

In order to be able to make a statement about the structure of the product investigated, which is in this case an electric toothbrush, the students disassembled their demonstrator into all its components. This process was documented via photos, among other tools, to make it visually clear how the division of tasks (practical work and documentation of information) was organized as efficiently as possible within the group. Through collaborative communication between the students, the resulting product architecture includes information on further product models and/or product specifications (other manufacturers, additional functions,...).

##### **Process Chains as Petri Nets**

Following the disassembly of the products into their components and the set-up of the product architecture, the students have prepared the process chains for the individual components within the “cradle-to-cradle” process as preparation for the life cycle inventories. The students already got to know the relevant method in the accompanying lecture as well as during the tutorial, enabling them to apply and deepen this method within their group. According to the individual needs of the group members, the students can complement each other in terms of content and collectively model the process chain of the entire product concerning all components identified in the product architecture before.

## 4.2 Feedback

Measuring the success of the newly developed project is based, on the one hand, on the fluctuation within the semester and, the ratio between the number of registrations and the number of exams. On the other hand, anonymous as well as face-to-face feedback sessions were offered to the students and then evaluated at the end of the semester.

Since 95% of the registered students submitted a final presentation in the semester considered, there is a high level of interest by the students visible during this first iteration. In addition, the evaluation of the content and organization of the design project was positive. Another repeated aspect mentioned by the students refers to the possibility of holding a final presentation as a student group. These feedbacks support the advantages of project-based learning for strengthening not only leverage effects in terms of content, but also social integration in group structures.

The students' feedback after completing the course supports the previously made statements about the effects of the last online semesters. On the one hand, the possibility of working together in a group of students throughout the entire semester was positively noted, as this professional and private exchange provided a considerable additional value. On the other hand, the expected high degree of independence, especially regarding the autonomous calculation of LCAs, was perceived as partly overstraining, since the actual procedure within the framework of the applicable standards was left to the students and was not restricted by the lecturer. In sum, the overall project was recommended by the students for the coming iterations, allowing further adjustments to be made in the area of formulating assignments and guidelines to meet the students requirements.

## 5 Conclusions and Outlook

Within the scope of the student design project conducted, the various fields of project-based learning were applied and consciously promoted by the developed project concept. The cognitive as well as the content-related and collaborative components could be integrated in this project in a targeted way.

### Cognitive and Content Learning

Regarding the potential cognitive and content-related benefits of PBL, various pros and cons of the design project can be identified. On the one hand, the development and implementation of the project enabled the students to investigate and apply new, previously unknown approaches within a classical engineering discipline. In addition, the students independently organized themselves as a group throughout the semester and consequently learned additional soft skills as well as implemented them via project plans, etc. Considering the content, both the students' use of previously unknown technical tools and the group's internal data management have been investigated. The several Petri nets created and resulting LCAs calculated have been modified according their functional units and the level of detail considered. This enabled the students to implement a component-specific division of the tasks, to reduce the necessary processing times and thus to present their results in the form of a coherent final presentation.

### Collaborative Learning

As the focus within this project, was on the exploitation of the collaborative potentials

within project-based group work, the first iteration and the results generated can be considered to be positive. The continuous work on activities, of which only half had a collaborative component, enabled the students to build up a comfortable and at the same time creative working atmosphere, which resulted in new impulses for the development of sustainable products to be pursued further in future projects. For the specific example of electric toothbrushes, these were, for instance, the development of manufacturer-independent standardized charging stations or the reduction of the brush head volume to be exchanged in order to only replace the brush fibers in a modular way. These projects help students to learn to work independently, which in turn leads to a noticeable increase in interest in the topics to be taught, providing a high level of added value for all participants.

Based on the feedback of the students, the subject-specific material, e.g. guidelines for the usage of sustainability accounting tools, will be further developed in the coming semesters in order to be able to offer the students information appropriate to their needs. Furthermore, the aim should be to maintain the students' knowledge throughout the projects to be able keep a kind of "project knowledge" regarding the development of sustainable products.

In addition to optimizing the design project for students, further events are planned by the institute to raise awareness among groups in the university environment. As an example, students of the region of Hanover will be offered a free supervision program during the summer vacations in form of a summer school. In this case, the aim is not only to convey the content as effectively as possible, but rather gain access to potential young engineers in a relaxed and enjoyable way and for raising their awareness.

Regarding future iterations of the project, it has become evident that the increase of interdisciplinarity in terms of the student composition as well as the aspects to be dealt with improves the communicability of the topic to be addressed. Although the ecological dimension and assessment of the technical systems will remain the focus of the project, ethical and economic implications cannot be neglected.

**Acknowledgement.** The concept of this course was funded by the "Curricular Innovations" of the Faculty of Mechanical Engineering of the Leibniz University Hannover through study quality funds (Studienqualitätsmittel, SQM).

## References

1. Leifler, O., Dahlin, J.-E.: Curriculum integration of sustainability in engineering education – a national study of programme director perspectives. *IJSHE* **21**(5), 877–894 (2020). <https://doi.org/10.1108/IJSHE-09-2019-0286>
2. Graham, R. (2010): UK Approaches to Engineering Project-Based Learning. White Paper sponsored by the Bernard M. Gordon-MIT Engineering Leadership Program. MIT

3. Olsen, S.I., Fantke, P., Laurent, A., Birkved, M., Bey, N., Hauschild, M.Z.: Sustainability and LCA in engineering education – a course curriculum. *Proc. CIRP* **69**, 627–632 (2018). <https://doi.org/10.1016/j.procir.2017.11.114>
4. Perpignan, C., Baouch, Y., Robin, V., Eynard, B.: Engineering education perspective for sustainable development: a maturity assessment of cross-disciplinary and advanced technical skills in eco-design. *Proc. CIRP* **90**, 748–753 (2020). <https://doi.org/10.1016/j.procir.2020.02.051>
5. McGibbon, C., van Belle, J.-P.: Integrating environmental sustainability issues into the curriculum through problem-based and project-based learning: a case study at the University of Cape Town. *Current Opin. Environ. Sustainab.* **16**, 81–88 (2015). <https://doi.org/10.1016/j.cosust.2015.07.013>
6. Sharma, A., Dutt, H., Venkat, S., Naveen, C., Naik, S.M.: Impact of project based learning methodology in engineering. *Proc. Comput. Sci.* **172**, 922–926 (2020). <https://doi.org/10.1016/j.procs.2020.05.133>
7. Lasauskiene, J., Rauduvaite, A.: Project-based learning at university: teaching experiences of lecturers. *Proc. Soc. Behav. Sci.* **197**, 788–792 (2015). <https://doi.org/10.1016/j.sbspro.2015.07.182>
8. Gunstone, R. (ed.): Springer, Dordrecht (2015). <https://doi.org/10.1007/978-94-007-2150-0>
9. Kokotsaki, D., Menzies, V., Wiggins, A.: Project-based learning: a review of the literature. *Improv. Schools* **19**(3), 267–277 (2016). <https://doi.org/10.1177/1365480216659733>
10. Menchaca, I., Guenaga, M., Solabarrieta, J.: Project-based learning: methodology and assessment learning technologies and assessment criteria. In: Conole, G., Klobučar, T., Rensing, C., Konert, J., Lavoué, É. (eds.) *Design for Teaching and Learning in a Networked World*. LNCS, vol. 9307, pp. 601–604. Springer, Cham (2015). [https://doi.org/10.1007/978-3-319-24258-3\\_68](https://doi.org/10.1007/978-3-319-24258-3_68)
11. Lehmann, M., Christensen, P., Du, X., Thrane, M.: Problem-oriented and project-based learning (POPBL) as an innovative learning strategy for sustainable development in engineering education. *Eur. J. Eng. Educ.* **33**(3), 283–295 (2008). <https://doi.org/10.1080/03043790802088566>
12. Stevanoviü, J., Atanasijevii, S., Atanasijevii, T., Zahar, M.: Expanding the level of engineer knowledge for software modeling within corporate education by active and collaborative learning. In: *2020 IEEE Global Engineering Education Conference (EDUCON)* (2020). <https://doi.org/10.1109/EDUCON45650.2020.9125250>
13. International Standard Organization: *Umweltmanagement – Ökobilanz – Grundsätze und Rahmenbedingungen (ISO 14040:2006 + Amd 1:2020)* Deutsches Institut für Normung e.V. Beuth Verlag GmbH, Berlin (2021)
14. Wurst, J., Mozgova, I., Lachmayer, R.: Sustainability assessment of products manufactured by the laser powder bed fusion (LPBF) process. *Proc. CIRP* **105**, 243–248 (2022). <https://doi.org/10.1016/j.procir.2022.02.040>

**Open Access** This chapter is licensed under the terms of the Creative Commons Attribution 4.0 International License (<http://creativecommons.org/licenses/by/4.0/>), which permits use, sharing, adaptation, distribution and reproduction in any medium or format, as long as you give appropriate credit to the original author(s) and the source, provide a link to the Creative Commons license and indicate if changes were made.

The images or other third party material in this chapter are included in the chapter's Creative Commons license, unless indicated otherwise in a credit line to the material. If material is not included in the chapter's Creative Commons license and your intended use is not permitted by statutory regulation or exceeds the permitted use, you will need to obtain permission directly from the copyright holder.





# Classifying Multi-generational Products for the Circular Economy

Buddhika M. Hapuwatte<sup>(✉)</sup> , Fazleena Badurdeen , and I. S. Jawahir 

Institute for Sustainable Manufacturing (ISM), University of Kentucky, Lexington, KY, USA  
hapuwatte@uky.edu

**Abstract.** Manufacturers are increasingly interested in the circular economy (CE) and potential of circular productions. To fully utilize CE, better guidance at the design stage is needed to establish closed-loop flows and prioritize higher value retaining end-of-use (EoU) practices such as reuse and remanufacture (i.e., parts harvesting). Intergenerational commonality (IC) is a method to increase EoU parts harvesting. However, closed-loop parts harvesting potential depends on the compatible timing between design generations' production and EoU returns curves. Therefore, in this paper, we explore an approach to make an initial assessment on where IC as a closed-loop CE strategy can produce most benefit, where such closed-loops may fall short, and what favorable design decisions can be made. The proposed indicator (based on the ratio between product's average usable lifetime and time between generation introductions,  $u_{avg}/t_{intro}$ ) provides a basis for developing an objective design-support tool. Using a hypothetical example, we discuss the approach and effectiveness of this indicator. The insights gained suggest that overall production's sustainability performance show substantial improvement when  $u_{avg}/t_{intro} < 1.25$ , and the IC benefits are highest when  $0.25 < u_{avg}/t_{intro} < 2.0$ . We also highlight a few managerial insights gained from the indicator useful to strategize EoU recovery and IC.

**Keywords:** Circular Economy · Multi-generational products · Sustainable Manufacturing · Closed-loop production

## 1 Introduction

Circular economy (CE) promotes switching from the traditional *take-make-use-dispose* economy to a restorative and regenerative one [1]. Due to increasing regulations, such as *extended producer responsibility*, manufacturers also have a vested interest in exploring closed-loop CE productions [2]. Achieving full sustainability potential of closed-loop flows requires prioritizing *reuse* and *remanufacture* at the component-level (i.e., EoU parts harvesting), over conventional practices like recycling [3]. However, this is acutely challenging with increasing rate of product design generation refreshes.

A significant part of the challenge is the mismatch between product demand (i.e., production flow) and EoU returns flows. As Fig. 1 depicts, a generation's (say, Gen1) return curve lags its production curve by the product's *average useful life* ( $u_{avg}$ ) [4, 5].

For example, when a smartphone’s average useful lifetime is passed, the demand for that generation is markedly reduced [6]. One generation’s potential parts harvesting depends on the overlap between its production and return curves. However, suppose some components (used here to refer to parts, components, modules) have *shared designs* between the successive generations (i.e., *intergenerational commonality—IC* [3]). That brings additional parts harvesting potential between generations if Gen2 production and Gen1 returns curves overlap (Fig. 1). Multi-generational product designing—design considering successive product generations—capitalizes on these opportunities. For example, overall sustainability performance of multi-generational product systems (PS) can be optimized by carefully selecting the IC level [7].

However, as Fig. 1 illustrates, different product’s Gen1 return flows may start at different points in time, depending on product and market characteristics. At early design stages, the problem is that the designers lack objective methods to assess a product and its PS to decide on IC.

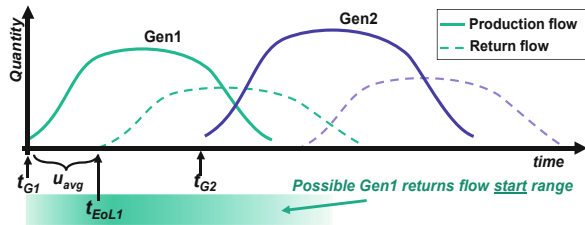


Fig. 1. Production and return curves in multi-generational PS

Because increasing commonality can also limit product functionality/performance (e.g., due to restrictions in using newer technology incompatible with the prior generation), these decisions must be taken considering the *overall* sustainability implications. Only a very few work [4, 5] discusses multi-generational sustainable product design. Therefore, this work aims to explore a potential method and an indicator for designers to make initial assessments of a PS’s suitability for closed-loop production and IC. Though this paper focuses on a single product system for brevity, the idea also extends to product families. To analyze a multi-generational PS and its sustainability performance during the design stage, first, the closed-loop production must be forecasted (Sect. 2). Then, Sect. 3 discusses the analysis of this PS using the proposed indicator.

## 2 Simulation Setup

We use a prior simulation framework [4] that can forecast sales and return curves and then calculate its sustainability performance. A detailed description of the framework is available in the original publication [4]. This section summarizes the pertinent calculations.

Model assumes that both *newly manufactured* (containing only brand-new components) and *rebuilt* (containing at least one reused/remanufactured component) products fulfill the market demand and are made to similar specifications. Therefore, the customers do not differentiate them. Parameters such as product’s useful life, return/reusable/remanufacturable/recyclable rates, and demand are typically value distributions. Since this method is to be used at product design stage, the calculations are done using forecasts (i.e., imperfect information) of those parameters. Prior work [8] has shown how the Monte-Carlo method can introduce stochastic modeling to represent



uncertainty in such cases. In this work, those parameters are assumed to be deterministic. The diffusion parameters  $p$  and  $q$  are assumed to be the same for Gen1 and Gen2 [7]. For simplicity, we model only the variable costs and GHG emissions.

### 2.1 Modeling the Product Demand and Returns

Previous work discussed [7] the use of the Norton-Bass (NB) diffusion model [9] to simulate the sales of two generations of a product. NB model Eqs. (1) and (2) describe demand variations  $D_1(t)$  and  $D_2(t)$  for Gen1 and Gen2, respectively. All symbols have usual meanings [7] (and also provided in Table 1). Assuming the interval ( $t_{intro}$ ) between generation introductions are the same (e.g., yearly refresh of smartphone generation), when  $\tau_i$  is introduction time of Gen- $i$ ,  $\tau_3$  can be approximated by  $\tau_2 + t_{intro}$ .

$$D_1(t) = F(t)m_1[1 - F(t - \tau_2)] \tag{1}$$

$$D_2(t) = F(t - \tau_2)[m_2 + F(t)m_1][1 - F(t - \tau_3)] \tag{2}$$

**Table 1.** Parameter values used

Parameter name	Sym.	Value
Coeff. of innovation	$p$	0.01
Coeff. of imitation	$q$	0.60
Gen1 market potential	$m_1$	5000
Gen2 additional market	$m_2$	1500
Number of components	$C_0$	5
EoU recovery ratio	$R_i$	0.6
<b>Component-level:</b>		
Reusability ratio	$\gamma^{reuse}$	30%
Reuse cost*		10%
Reuse GHG*		
Reman.ability ratio	$\gamma^{reman}$	30%
Reman. Cost*		30%
Reman. GHG*		40%
Recyclability ratio	$\gamma^{recyc}$	20%
Recycling cost*		50%
Recycling GHG*		60%
Dispose	$\gamma^{dispo}$	20%
Dispose cost*		10%
Dispose GHG*		40%
Monetary discount rate	$APR$	6%

\* Compared to newly manufacture

When  $p$  is the *coefficient of innovation* and  $q$  is the *coefficient of imitation* [10],

$$F(t) = \frac{1 - e^{-(p+q)t}}{1 + \frac{q}{p}e^{-(p+q)t}}, t \geq 0. \tag{3}$$

We assume the manufacturer’s marketing department provides baseline parameter values, including  $p$ ,  $q$ , and  $m$ , based on their historical and market data. Estimation of these parameter values is discussed prior [4, 8], and beyond the scope of this paper.

**2.2 Production-Mix Calculations**

To forecast the production requirements, we use the *configuration design* framework [11, 12]. Product is considered to include  $C_0$  number of distinct *component-types*. For Gen2, the designs of these components can have two choices (indexed  $v$  in the below equations): 1) a design *common* with Gen1 (which allows intergenerational parts harvesting), or 2) a *new design*. However, at least one component of Gen2 out of the total number  $C_0$  must be a *new design* to differentiate the Gen2 product from the Gen1.

Product sustainability metrics are set to vary according to the component choices. Therefore, first, the component-level production plan for each production period (i.e., *production-mix* [7]) is calculated. Then, the sustainability metrics are forecasted based on the said production-mix. Finally, the metrics are aggregated and averaged for the entire production run for ease of analysis [7].

The number of Gen- $i$  recovered products in time  $(t + u_{avg})$  is given by Eq. (4). The model assumes the forward and returns logistics time is negligible (or, can be included in  $u_{avg}$ ). Therefore, the returns curve follows the demand curve with a delay of  $u_{avg}$  [4]. The proportion of Gen- $i$  products returning to closed-loop production flow out of the total reaching their EoU is the recovery rate ( $R_i$ ).

$$N_i^{recov}(t + u_{avg}) = D_i(t)R_i, \quad i = 2 \tag{4}$$

Once the products are returned at EoU, the manufacturer disassembles those to the component level. Initially, the EoU components are allotted to different EoU streams (reuse, remanufacture, recycle, and dispose) according to the expected availability rates ( $\gamma_{i,c,v}^x$ , where  $x$  can be EoU activities like reuse, remanufacture, and recycle). When  $c$  is the component-index, these component-level numbers are given by,

$$N_{i,c,v}^x(t + 1) = \gamma_{i,c,v}^x N_i^{recov}(t), \tag{5}$$

where  $i = 1, 2, c = 1, 2, \dots, C_0, v \in \{1, 2\}$ .

Assuming that only a single instance of each component-type is present in a product, Eq. (6) gives the number of components needed in each period  $t$ .

$$N_{i,c,v}^{prod}(t) = D_i(t), \quad i = 1, 2, c = 1, \dots, C_0, \text{ and } v \in \{1, 2\}. \tag{6}$$

The *production-mix* is the combination of the number of newly manufactured, reused, and remanufactured components produced in a period [7]. Therefore, it is calculated by the general expression,

$$N_{c,v}^{prod}(t) = N_{c,v}^{newmanu}(t) + N_{c,v}^{reuse}(t) + N_{c,v}^{reman}(t), \quad (7)$$

where,  $c = 1, \dots, C_0$ ;  $v \in \{1, 2\}$ .

The *sustainable activity hierarchy* [13] is used to find the most efficient recovery paths. Therefore, successive period's demand for each component type is tried to fulfill with the recovered components—first, with the available *reuse* components, and then with the available *remanufacture* components. Only when those two cannot fulfill the demand the *new manufacture* option will be used. Any excess after fulfilling the demand will be allocated to recycling as the next best recovery option.

**Modeling the Product Sustainability Metrics:** The calculation of sustainability performance is also done similarly to the prior literature [7, 8]. The basic idea is that the sustainability metrics of interest are calculated for each type of newly manufactured, reused, remanufactured, and recycled component for both Gen1 and Gen2. Therefore, when  $U_{c,v}^{activity}$  denote the unit value metric  $x$  (e.g., cost), for the component-type  $c$ , and variation  $v$ ,

$$\begin{aligned} \text{Costofproductionatt} = & N_{c,v}^{newmanu}(t) * U_{c,v}^{newmanu} + \\ & N_{c,v}^{reuse}(t) * U_{c,v}^{reuse} + N_{c,v}^{reman}(t) * U_{c,v}^{reman} + \\ & N_{c,v}^{recyc}(t) * U_{c,v}^{recyc} + N_{c,v}^{dispose}(t) * U_{c,v}^{dispose}, \end{aligned} \quad (8)$$

where,  $c = 1, \dots, C_0$ ;  $v \in \{1, 2\}$

Similarly, the other relevant metrics can also be calculated. For economic metrics, when aggregating the per-period cost to calculate the total cost for the production, the value of money is discounted at a set rate. Its *present value* is calculated in reference to Gen-1 introduction time (i.e., *period 1*).

### 3 Classification Method and Discussion

We propose  $u_{avg}/t_{intro}$  as an initial indicator for classifying the suitability of a product for closed-loop production. Both  $u_{avg}$  and  $t_{intro}$  are typical PS parameters, ascertainable at design stage. The use of this indicator is presented employing the following hypothetical test case. The production simulation model detailed in Sect. 2 is utilized with the nominal values of Table 1. These values were selected to represent typical product's values. Since only nominal values were used, the discussion below focuses on the overall results trends rather than the magnitudes. The two representative metrics *manufacturing cost* and *GHG emissions* for the overall production are charted, taking  $u_{avg}/t_{intro}$  as the independent variable. These two metrics were selected due to the common usage and ease of calculation for this proof-of-concept study. However, more comprehensive sustainability metrics are necessary for an exhaustive evaluation.

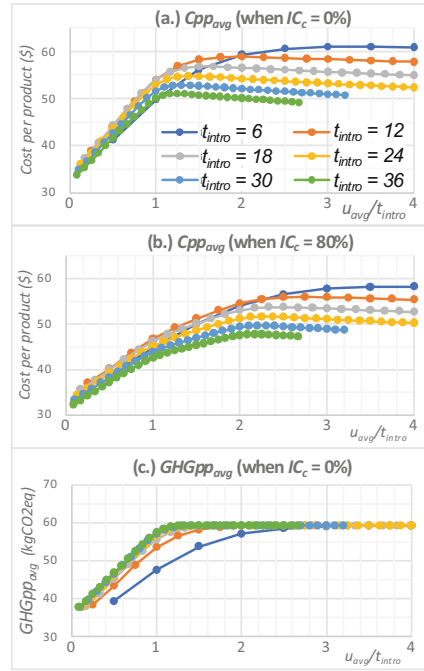
Following assumptions are made to simplify and make the results more general. The component-types are assumed to be similar in terms of unit cost and unit GHG emissions so that their variability does not affect metrics. It also allows calculating Gen2's *component-level IC* ( $IC_C$ ) with Gen1 as a percentage of common components ( $C_{common}$ ) in a product (i.e.,  $IC_C = C_{common}/C_0$ ). Compared to Gen1 component designs' nominal cost (\$10) and GHG emissions (10 kgCO<sub>2</sub>) values, the new-design (i.e., Gen2's *non-common*) components are assumed 10% costlier (due to production changes necessary) and 20% less GHG emitting (due to efficiency improvements in new technology). The same reusability, remanufacturability, and recyclability rates are assumed for all component-types. Below discussion uses *per product averaged* metric values of *manufacturing cost* ( $C_{pp_{avg}}$ ) and *GHG emissions* ( $GHG_{pp_{avg}}$ ) to minimize the effect of number of products sold. For the discussion and visualization simplicity, these averages are for the combined production of Gen1 and Gen2.

### 3.1 General Trends

To test if the indicator  $u_{avg}/t_{intro}$  can be used with different product categories, the simulation was run for different  $t_{intro}$  values, and checked if the trends in metrics hold. Figure 2a & 2b illustrate the variation of  $C_{pp_{avg}}$  with  $u_{avg}/t_{intro}$ , for different  $t_{intro}$  values when the  $IC_C$  is 0% and 80%, respectively. For all  $t_{intro}$  values, there is a common trend in average cost declining considerably for lower  $u_{avg}/t_{intro}$  ratios (< 1.25). It is understandable since lower  $u_{avg}/t_{intro}$  means a larger overlap between production and return curves, allowing greater parts harvesting for reuse/remanufacture. Furthermore, higher IC allows a lower cost over a greater range of  $u_{avg}/t_{intro}$  (e.g.,  $IC_C = 0\%$  plateaus by  $u_{avg}/t_{intro} = 1.25$ , whereas  $IC_C = 80\%$  plateaus only after  $u_{avg}/t_{intro} = 2.0$ ). It means higher IC allows a longer time window for manufacturer to repurpose EoU components in reuse/remanufacture. In Fig. 2c,  $GHG_{pp_{avg}}$  also reveals a similar overall trend. Unlike  $GHG_{pp_{avg}}$  curves, in  $C_{pp_{avg}}$  (Figs. 2a & 2b), each  $t_{intro}$  curve plateaus to a distinct final cost level. It is explained by discounting of monetary value (i.e., cost) over time.

### 3.2 EoU Strategy and Returns Planning

Strategizing the EoU recovery and returns planning is critical to designing closed-loop and CE-focused products [13]. Consider a product where  $t_{intro}$  is 12 months; according to Fig. 3a, if  $u_{avg}$  is 24 months, the average per-product cost is \$ 57.6; and if  $u_{avg}$  is



**Fig. 2.** Cost and GHG emissions metrics variation with  $u_{avg}/t_{intro}$

18 months, it is \$53.3. This is a 7.4% cost reduction if the EoU returns can be collected sooner (since some EoU products stay with customers for a long time after becoming EoU). This insight is beneficial for the manufacturer to plan product return incentives so that returns are more likely to happen when there is more opportunity for parts harvesting. It highlights the importance of considering not only how much EoU products are returned (i.e., recovery rate), but also *at which time point*. Consequently, product sustainability measurements must be treated *dynamic* (i.e., *temporally-variable*) [8].

Although per component GHG emissions are higher in the *common* design (since we assumed *new* component designs 20% more GHG efficient), Fig. 3b shows, from  $0.5 < u_{avg}/t_{intro} < 1.5$ , there is still a potential to lower the overall average GHG emissions of production through increased reuse and remanufacture opportunities resulting from IC. Therefore,  $IC_C$  and  $u_{avg}/t_{intro}$  indicators are vital factors for planning EoU recovery.

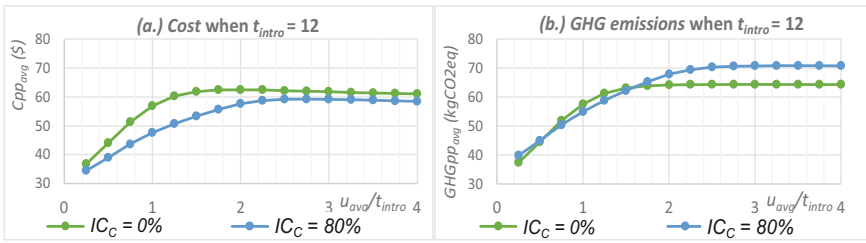


Fig. 3. Cost and emissions variation for different commonality levels ( $IC_C = 80\%$  and  $0\%$ )

### 3.3 Planning Component Commonality with $u_{avg}/t_{intro}$

Figure 4 further illustrates the *relative* cost (Fig. 4a) and GHG emissions (Fig. 4b) difference between commonality level 80% vs 0%, for several  $t_{intro}$  values. These charts show that the benefit of component commonality becomes highest during  $0.25 < u_{avg}/t_{intro} < 2.0$ . For most  $t_{intro}$ , the  $u_{avg}/t_{intro} = 1$  provides the highest benefits. Notably, when  $u_{avg}/t_{intro}$  is small (say,  $< 0.25$ ), the IC level matters less. This is because, in such cases, a considerable portion of the returns happens within the same generation’s production. Thus, when a product’s  $u_{avg}/t_{intro}$  ratio is very low, the manufacturer can focus more on devising designs with more efficient component designs (i.e., *new* designs) without being limited by the need to increase IC.

Overall, this case presents a preliminary view of the proposed classification approach. Additional work needs to be done with real industry case studies to validate these results. Furthermore, the preliminary work here is a reminder of the need to explore more complex strategies for closed-loop CE. Reconfigurable and cross-product fungible components can decouple the need for overlap between production and return flows of the same product’s generations. For example, a module that is made common between multiple product categories can lead to parts harvesting over a longer time and more applications. However, the approach presented in this paper can also be extended to such cases by considering the module level aggregate demand.

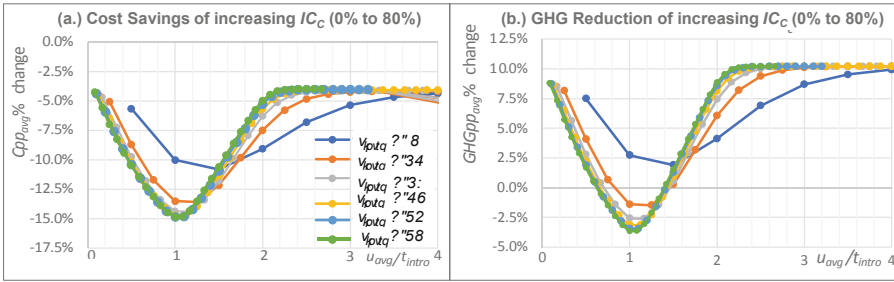


Fig. 4. Impact of increasing the inter-generational commonality ( $IC_C$ ) from 0% to 80%

### 4 Conclusions

For manufacturers and designers planning products for the CE, an objective indicator capable of providing a preliminary understanding regarding multi-generational PS’s suitability for closed-loop production can be extremely useful. In this paper, we present the indicator  $u_{avg}/t_{intro}$  as a potential solution. By examining the variation of sustainability metrics relative to  $u_{avg}/t_{intro}$ , it was found to be usable with different  $t_{intro}$ .

Based on the hypothetical example examined, a common trend showed that the overall multi-generation production’s sustainability metrics (average cost and GHG emissions) show marked improvements in lower  $u_{avg}/t_{intro}$  ratios (significantly when  $u_{avg}/t_{intro} < 1.25$ ). While  $u_{avg}$  and  $t_{intro}$  are typically set considering product and market characteristics, manufacturers can use the insights gained from the indicator to strategize EoU recovery and plan IC. For example, manufacturers can use the proposed indicator and the analysis when planning a return incentive scheme to influence  $u_{avg}$  and obtain EoU products at the most opportune time (i.e., when there is more opportunity for parts harvesting). And, since the IC benefits are highest during a limited range (i.e.,  $0.25 < u_{avg}/t_{intro} < 2.0$ ), manufacturer can either use the commonality level to expand that range, or focus on choosing more efficient component designs (i.e., new designs) without needing to make the generations more common. This work will be further extended by considering more variables and actual test cases to validate and develop a more robust indicator that factors additional product and PS characteristics.

**Acknowledgement.** The authors acknowledge the contributions made by Dr. Ryan Bradley, especially by providing the industrial perspective when preparing this study.

### References

1. Ellen MacArthur Foundation: Towards the Circular Economy: An economic and business rationale for an accelerated transition. Ellen MacArthur Foundation (2013)
2. Kaffine, D., O’Reilly, P.: What have we learned about extended producer responsibility in the past decade? A survey of the recent EPR economic literature. OECD (2013)

3. Hapuwatte, B.M.: Redesigning products to optimize sustainable performance in multi-generational closed-loop production for advancing the circular economy. Mechanical Engineering, Ph.D. University of Kentucky (2021)
4. Debo, L.G., Toktay, L.B., Wassenhove, L.N.V.: Joint life-cycle dynamics of new and remanufactured products. *Prod. Oper. Manag.* **15**, 498–513 (2006)
5. Östlin, J., Sundin, E., Björkman, M.: Product life-cycle implications for remanufacturing strategies. *J. Clean. Prod.* **17**, 999–1009 (2009)
6. Ewa, W.-J., Milosz, P., Martyna, K., Michal, N.: Apple products: a discussion of the product life cycle. In: 2017 International Conference on Management Science and Management Innovation (MSMI 2017), pp. 159–164. Atlantis Press (2017)
7. Hapuwatte, B.M., Badurdeen, F., Bagh, A., Jawahir, I.S.: Optimizing sustainability performance through component commonality for multi-generational products. *Resour. Conserv. Recycl.* **180**, 105999 (2022)
8. Hapuwatte, B.M., Seevers, K.D., Jawahir, I.S.: Metrics-based product sustainability evaluation of multi-period productions for circular economy. *J. Manuf. Syst.* **64**, 275–287 (2021)
9. Norton, J.A., Bass, F.M.: A diffusion theory model of adoption and substitution for successive generations of high-technology products. *Manage. Sci.* **33**, 1069–1086 (1987)
10. Bass, F.M.: A new product growth for model consumer durables. *Manage. Sci.* **15**, 215–227 (1969)
11. Wielinga, B., Schreiber, G.: Configuration-design problem solving. *IEEE Expert* **12**, 49–56 (1997)
12. Badurdeen, F., Aydin, R., Brown, A.: A multiple lifecycle-based approach to sustainable product configuration design. *J. Clean. Prod.* **200**, 756–769 (2018)
13. European Commission: Directive 2008/98/EC on waste. (2008)

**Open Access** This chapter is licensed under the terms of the Creative Commons Attribution 4.0 International License (<http://creativecommons.org/licenses/by/4.0/>), which permits use, sharing, adaptation, distribution and reproduction in any medium or format, as long as you give appropriate credit to the original author(s) and the source, provide a link to the Creative Commons license and indicate if changes were made.

The images or other third party material in this chapter are included in the chapter's Creative Commons license, unless indicated otherwise in a credit line to the material. If material is not included in the chapter's Creative Commons license and your intended use is not permitted by statutory regulation or exceeds the permitted use, you will need to obtain permission directly from the copyright holder.





# Design for Sustainability in Manufacturing – Taxonomy and State-of-the-Art

Vivien Langer<sup>(✉)</sup>, Annika Tampe, and Uwe Götze

Chair of Management Accounting and Control, Chemnitz University of Technology,  
09107 Chemnitz, Germany

[vivien.langer@wiwi.tu-chemnitz.de](mailto:vivien.langer@wiwi.tu-chemnitz.de)

**Abstract.** To meet sustainability goals, manufacturing companies are faced with the challenge of using renewable resources as well as innovative processes to design and manufacture sustainable products. For this purpose, the Design for Sustainability (DfS) approach has been suggested. Since there is no uniform understanding of how such a concept should work and which methods should be applied within it, the paper is intended to provide an overview of existing approaches. Therefore, a taxonomy of DfS approaches is introduced to enable a systematic and differentiated analysis. Afterwards, a literature review is conducted and a comprehensive overview of DfS concepts is provided. This allows for uncovering research needs towards an established DfS approach.

**Keywords:** Design for Sustainability · Design for X · Sustainable Manufacturing

## 1 Introduction

Due to the depletion of existing resources and the increasing pollution of the environment, sustainability is more and more important. While there is still no uniform definition, the one of the Brundtland Report is often used. It defined sustainable development as meeting the needs of the present generation without compromising the needs of future generations [1]. Nowadays, the Triple Bottom Line is often referred to as a uniform conceptual element of sustainability: Sustainability refers to an environmental, an economic and a social dimension [2]. Against this background of increased striving for sustainability as well as the high relevance of the manufacturing sector for achieving the global sustainable development goals, the idea of sustainability in manufacturing should be considered in product design processes. This can be done by using the Design for Sustainability (DfS) approach. Although this quite novel approach is promising, a holistic concept with established methods for DfS still seems to be missing. Furthermore, an overview of the state-of-the-art of DfS does not exist. There is no substantiated knowledge answering the questions to what objects DfS refers, which tasks should be accomplished by DfS, and which way DfS is theoretically founded. This motivates the paper: By conducting a systematic literature review on DfS in the context of manufacturing such an overview



should be given in order to enable further scientific development of the DfS approach and methods. To achieve this objective, relevant literature is identified and analyzed regarding various criteria that are defined in a DfS taxonomy.

## 2 Design for X and Design for Sustainability

**Design for X (DfX)** is an umbrella term representing a wide variety of approaches [3]. It can be noticed that there are more than 75 different DfX methods focusing on various aspects during the product design and manufacturing processes [4]. DfX approaches show two ways of interpreting the ‘X’ included in the term. On the one hand this ‘X’ represents a life cycle phase, e.g., manufacturing, service, or recycling. On the other hand it refers to a product property, e.g. cost, quality or safety [5]. This goes along with a large number of terms that can be used for the X resulting in various DfX concepts. They comprise DfS approaches striving for a systematic consideration of sustainability in design processes for products, processes, or resources.

**Design for Sustainability** is considered to have evolved from the Design for Environment (DfE) or Eco-Design approach [6]. Accordingly, great attention is paid to resource efficiency and sustainable consumption. However, a perfect product design concept should consider all three pillars of sustainability [7] in order to create sustainability-oriented innovations which aim at reducing the negative – and strengthen the positive – life cycle-related impacts of products within these three pillars [8]. Such a design approach can be understood as a DfS approach in a narrow sense. Nevertheless, another subset of all DfX approaches – those ones focusing on at least one sustainability dimension – can also contribute to reach sustainability targets (such as DfE for an environmental focus). They are seen as DfS approaches in a broader sense, here. In order to provide a significant overview, this study also includes such DfS approaches.

## 3 Taxonomy of Design for Sustainability Approaches

To present a significant picture of the state-of-the-art of the various DfS approaches existing in the manufacturing sector, a taxonomy is used. This taxonomy was derived from a taxonomy presented by Pecas et al. [9] who, amongst others, aim to study the state-of-the-art of life cycle engineering (LCE) – a similar group of concepts and methods – and intend to answer questions similar to those raised in the introduction.

The taxonomy (see Fig. 1) is structured in a hierarchical form. The first part – the **theory level** – considers the intended contribution of the analyzed publications. Here, their aim and content are characterized by answering the question “What is the intended type of contribution”? The second part of the taxonomy – the **design level** – is divided into two sub-levels. At the level of the **DfS activities**, the question “What is done by DfS” is to be investigated. In order to answer this question in a differentiated way, further sub-categories are considered. The target perspectives include the three dimensions of sustainability as well as aggregated target systems referring to two or all three dimensions. Another sub-level are the tasks that should be accomplished by DfS. Since the state-of-the-art of DfS approaches is to be investigated, it is to be expected that design (or engineering) is in the foreground. However, it is also conceivable that

evaluation tasks are considered instead of or in addition to design (this is one result of the literature survey about LCE [9], p. 77). Furthermore, the basic DfX approaches suggested, and the methods applied within them are investigated. The second sub-level are the **reference objects**, with the question to be answered “To what objects does DfS refer?”. The reference objects can be structured in sub-categories too, here including alternatives (products, processes, or resources), life cycle phases and target figures.

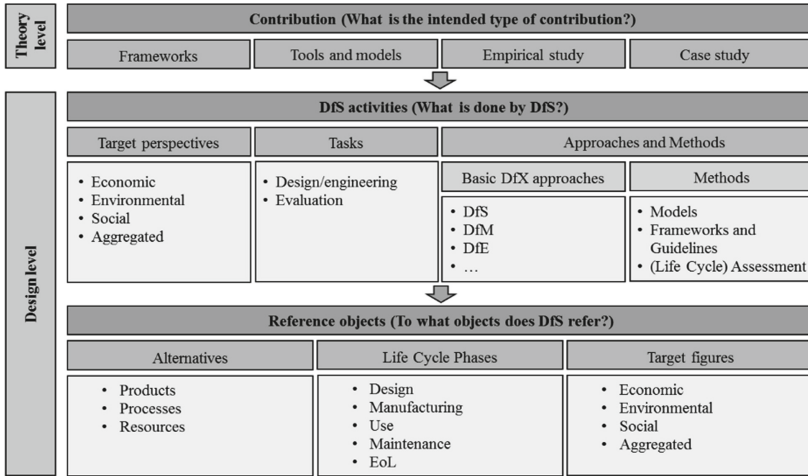


Fig. 1. Taxonomy

#### 4 Methodology of Literature Review

For providing the intended state-of-the-art, firstly the relevant publications had to be identified. To find such articles, adequate keyword combinations had to be defined, and suitable databases had to be selected. The literature research was done by using four databases: EBSCO, ScienceDirect, Scopus and Web of Science. For searching in these databases, keywords were selected and connected with the Boolean operator ‘AND’ to create key word combinations. These keyword combinations can be classified into three parts. The first section represents the combination of the search term ‘Design for X’ with either ‘sustainab\*’, ‘manufacturing’ or ‘production’. In the second section, ‘Design for Sustainab\*’ is connected to ‘manufacturing’ or ‘production’. Finally, ‘Design for’ was linked to either ‘sustainab\*’, ‘manufacturing’ or ‘production’ and additionally one of the three sustainability dimensions was added. Since a comprehensive overview of DfS in a narrow as well as in a broader sense was intended, the search not only focused on DfS (e.g., key word combination “‘Design for Sustainab\*’ AND ‘manufacturing’”), but also on DfX methods that address individual sustainability dimensions (e.g., key word combination “‘Design for’ AND ‘production’ AND ‘environmen\*’”). Afterwards, the resulting key word combinations were used for searching for results in the title of articles in the data bases. This initially allowed 205 results to be found after the duplicates were

removed. By scanning the abstracts (133 articles excluded), checking the bibliometric scores (H-index higher than 80 or VHB ranking of at least C; 45 papers excluded) and carrying out an in-depth analysis (twelve articles excluded) a total of 190 articles could be identified as not relevant. As a result, 15 articles remain as the most relevant publications, whereof one only provides an overview of existing approaches in the form of a literature review, which therefore was excluded. Nevertheless, this article as well as the other ones were used to find additional relevant literature using the snowball principle. Thus, two other publications were identified as relevant, which are therefore included in the in-depth analysis of 16 articles using the taxonomy (see chapter 3). The procedure of the literature review is presented in Fig. 2.

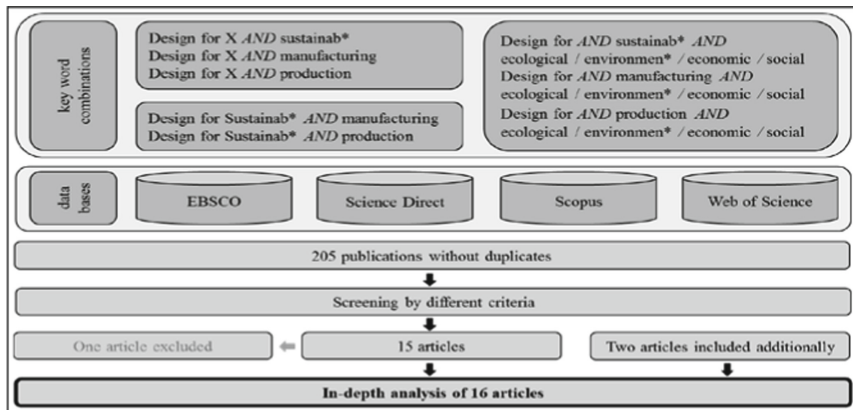


Fig. 2. Method of literature review

## 5 Results of Literature Review

For the in-depth analysis of the 16 selected articles, the DfS Taxonomy was applied. Consequently, they were firstly analyzed with regard to the intended **type of contribution**. Five articles represent purely methodological frameworks [3], [10–12] whereof one additionally focuses on behavioral aspects [7]. Seven other articles present methodological frameworks as well. Moreover, these frameworks are applied in case studies [8], [13–18]. Another publication combines a framework with a use case and a tool [19]. Of the remaining three publications, one is an empirical work [20], one is a methodical work suggesting a mathematical model [21] and one is a methodical work that presents a model and its application in a case study [22].

The **activities** sub-level follows in second place. Regarding the **target perspectives**, there are diverse results. Five articles focus exclusively on one sustainability dimension whereof three refer to the environmental perspective [10, 14, 16], and each one refers to the economic [22] as well as social dimension [13]. An economic and also environmental perspective is considered in four papers [17], [19–21]. These perspectives are supplemented by the social perspective in one paper [8]. Besides the individual evaluation of the

sustainability perspectives, an aggregated view on the holistic sustainability can be found in five publications [3, 11, 12, 15, 18]. In addition to the three sustainability dimensions, an institutional perspective is included in another article [7]. Concluding, it is noticeable that more than half of the analyzed papers refer to only one or two sustainability dimensions. Just one paper considers all three sustainability dimensions separately. Another five publications show an aggregated view. This shows a non-uniform picture with a diverse target-orientation of the approaches.

Concerning the **tasks**, the design/engineering perspective is at least indirectly taken in all identified publications. This is inherent in the character of the ‘Design for’ approaches. Nevertheless, there are three papers in which the task of evaluation is focused [13, 19, 22]. Seven articles only focus on design/engineering [3, 7, 8, 10, 17, 20, 21] and six articles consider both design/engineering and evaluation [11, 12], [14]–[16], [18]. Concluding, the emphasis within the tasks is on designing and engineering of the reference object which is often supplemented by an evaluation.

A very diverse understanding of the considered DfS concepts can be seen regarding the **approaches and methods** suggested. As a basic **DfX approach**, DfE was used in four publications [10, 14, 16, 21]. Additionally, there are four articles that specifically refer to DfS [3, 7, 8, 12]. Furthermore, Design for Manufacture and Assembly (DfMA) was mentioned twice [18, 22] and Design for Recycling (DfR) [19] and Design for Remanufacture [20] were noted once each as basic methods. A further development of the Design for Manufacture, the so-called Design for Sustainable Manufacture (DfSM), was addressed in three publications [11, 15, 17]. The social dimension was once focused on by usage of Design for Social Sustainability (DfSS) [13].

Regarding the **methods** in detail, a framework for DfSS was presented that contains guidelines as well [13]. Moreover, a conceptual methodological framework which shows a six-step approach including a formula for DfSM was suggested [17]. Three articles present mathematical models [14, 15, 21]. Assessment procedures were mentioned in three articles. One article uses different indicators for assessment e.g., to determine manufacturing costs, energy consumption as well as personal health & safety [11], while another publication calculates a normalized score and therefore uses life cycle inventory and unit process modelling as a basis [18]. A third article presents a combination of life cycle assessment (LCA) with an adapted methodology for eco-design, the so-called eco-briefing [16]. Moreover, three papers present models, whereof one paper uses a software tool that is based on a multi-attribute decision making method [19], the second one is based on a computer-aided design model [22] and the third one contains different performance metrics [10]. Additionally, five publications are limited to theoretical considerations that provide starting points for methodological approaches. One presents ideas to include social impact categories in the LCA method [12], one presents a DfS taxonomy that combines various DfX approaches [3], and a third one presents four possible DfS approaches to innovation [8]. Moreover, one paper suggests guidelines for DfRe [20] and another one focuses on principles for DfS [7].

Regarding the **reference objects** within the design level of the taxonomy, nine papers focus on just one type of **alternative** (eight aim at products [7, 8, 12], [17]–[21] and one concentrates on processes [22]). Furthermore, three studies address two alternatives, whereof two studies focus on products and processes [3, 14] and one paper takes products

and resources into account [16]. The other four studies include a third alternative. Three concentrate on products, processes, and resources [10, 11, 15] whereas one paper focuses on paradigms besides products and processes [13].

With regard to the considered **life cycle phases**, it is remarkable that the first group of DfX approaches explicitly bears one or more life cycle phases in its name (see chapter 2). However, this is not true for the remaining approaches. Therefore, all considered studies were examined in terms of their life cycle reference. The majority of papers analyzed (eleven out of 16) cover the entire life cycle (design, manufacture, use, maintenance, and EoL) [3, 7, 21, 8, 10, 12, 14, 15, 17, 19, 20], whereof two studies especially concentrate on the manufacturing and the EoL phase [20, 21]. One paper covers the product life cycle without the EoL phase [13]. Out of the remaining four papers, three focus on the planning and the manufacturing phases [11, 18, 22] and one takes the manufacturing phase exclusively into account [16].

Considering the **target figures**, there are five papers for which specific target figures are difficult or not at all to be named. These are the papers that are limited to theoretical considerations and do not suggest concrete methods [3, 7, 8, 12, 20]. However, there is one article that takes the *economic perspective* into account by using a method that leads to an optimized DfMA “decision” with lowest product manufacturing costs when considering engineering parameters as well [22]. Three papers present target figures that are related to the *environmental perspective*: an optimized overall utility [14], the environmental impact as target figure [16] and a focus on DfE principles that contain categorical as well as numerical characteristics [10]. The *social dimension* is addressed by just one paper [13] where 16 criteria are used as target figures. From the three papers referring to the *economic* and *environmental* perspective, the Global Recycling Index [19], a method that has an optimal DfE effort level as target figure [21], and a specific KPI (the life cycle commonality metrics) [17] are considered. The remaining three papers suggest an *aggregated* target figure considering all three *sustainability dimensions*: a Sustainability Index [15], a normalized score [18] and an acceptable sustainability level for products or processes [11]. Concluding, the analysis shows a variety of target figures are used even within the individual sustainability dimensions.

## 6 Conclusion

Based on a taxonomy presented, this paper analyzed the state-of-the-art of DfS concepts in the narrower and broader sense by doing a literature review. However, it should be noted that there are some methodological restrictions. First, the number of articles found is limited due to the key word combinations and databases used. In addition, the key words were searched exclusively in the titles of the paper. Moreover, the search was limited to DfS approaches related to manufacturing.

Regarding the analysis of existing DfS approaches, it can be noted that there are very few numbers (16) of papers that present DfS approaches with reference to manufacturing. Most of the approaches address only one or two of the sustainability dimensions. Articles that present a holistic method for DfS are clearly in the minority. It is particularly noteworthy that no two papers use the same methodology or the same target figures, even if papers refer to the DfS approach in a narrower sense. The great heterogeneity of

the methods used implies that a state-of-the-art methodology does not exist. Furthermore, Life Cycle Costing as the accepted method for the evaluation of economic sustainability is not used in any of the papers analyzed. LCA as a state-of-the-art method for assessing environmental sustainability is used at least in some papers. These results are widely consistent with those of another literature review that focuses on the life cycle and sustainability-oriented assessment in the manufacturing sector [23].

As sustainability is becoming increasingly important, especially in the manufacturing sector, companies have to pay greater attention to using resource-saving processes and producing sustainable products. For enabling this, further studies should be directed towards developing a coherent and uniform methodology for DfS that takes the state-of-the-art of dimension-specific methods into account. Additionally, case studies should be conducted in order to validate and refine the methodology. By means of such a uniform methodology, it is then possible to compare the results of the case studies with each other and to derive significant conclusions regarding preferable alternatives.

**Acknowledgements.** This work was performed as part of the research projects EcoWing (chapter 1, 3, 4 and parts of chapter 2 and 5) and NeMaCell (chapter 6 and parts of chapter 2 and 5) (grant numbers: 100382174; 100382169), supported by the European Social Fund (ESF). Financial support is gratefully acknowledged.



## References

1. WCED (United Nations World Commission on Environment and Development). Our Common Future (1987)
2. Elkington, J.: Accounting for the triple bottom line. *Meas. Bus. Excell.* **2**(3), 18–22 (1998)
3. Arnette, A.N., Brewer, B.L., Choal, T.: Design for sustainability (DFS): the intersection of supply chain and environment. *J. Clean. Prod.* **83**, 374–390 (2014). <https://doi.org/10.1016/j.jclepro.2014.07.021>
4. Benabdellah, A.C., Bouhaddou, I., Benghabrit, A., Benghabrit, O.: A systematic review of design for X techniques from 1980 to 2018: concepts, applications, and perspectives. *Int. J. Adv. Manuf. Technol.* **102**(9–12), 3473–3502 (2019). <https://doi.org/10.1007/s00170-019-03418-6>
5. Andreasen, M.M., Mortensen, N.H.: Basic thinking patterns and working methods for multiple DFX. In: *Proceedings of the 8th Symposium on Design for Man*, pp. 7–12 (1997)
6. UNEP (United Nations Environment Programme), Design for sustainability. A Step-by-Step Approach (2009)
7. Spangenberg, J.H., Fuad-Luke, A., Blincoe, K.: Design for Sustainability (DfS): the interface of sustainable production and consumption. *J. Clean. Prod.* **18**(15), 1485–1493 (2010). <https://doi.org/10.1016/j.jclepro.2010.06.002>
8. Clark, G., Kosoris, J., Hong, L.N., Crul, M.: Design for sustainability: current trends in sustainable product design and development. *Sustainability* **1**(3), 409–424 (2009). <https://doi.org/10.3390/su1030409>

9. Peças, P., Götze, U., Henriques, E., Ribeiro, I., Schmidt, A., Symmank, C.: life cycle engineering - taxonomy and state-of-the-Art. *Procedia CIRP* **48**, 73–78 (2016). <https://doi.org/10.1016/j.procir.2016.04.085>
10. Ramanujan, D., Bernstein, W.Z., Totorikaguena, M.A., Ilvig, C.F., Ørskov, K.B.: Generating contextual design for environment principles in sustainable manufacturing using visual analytics. *J. Manuf. Sci. Eng.* **141** (2018). <https://doi.org/10.1115/1.4041835>
11. Kishawy, H.A., Hegab, H., Saad, E.: Design for sustainable manufacturing: approach, implementation, and assessment. *Sustainability* **10**(10), 3604 (2018). <https://doi.org/10.3390/su10103604>
12. Dewulf, W.: Design for sustainability - anticipating the challenge. In: *Proceedings of the International Conference on Engineering Design*, vol. DS 31. ICED (2003)
13. Corsini, L., Moultrie, J.: Design for social sustainability: using digital fabrication in the humanitarian and development sector. *Sustainability* **11**(13) (2019). <https://doi.org/10.3390/su11133562>
14. Carnahan, J.V., Thurston, D.L.: Trade-off modeling for product and manufacturing process design for the environment. *J. Ind. Ecol.* **2**(1), 79–92 (1998). <https://doi.org/10.1162/jiec.1998.2.1.79>
15. Garbie, I.H.: DFSME: design for sustainable manufacturing enterprises (an economic viewpoint). *Int. J. Prod. Res.* **51**(2), 479–503 (2013). <https://doi.org/10.1080/00207543.2011.652746>
16. González-García, S., et al.: Combined application of LCA and eco-design for the sustainable production of wood boxes for wine bottles storage. *Int. J. Life Cycle Assess.* **16**(3), 224–237 (2011). <https://doi.org/10.1007/s11367-011-0261-2>
17. Wang, W., Tseng, M.M.: Design for sustainable manufacturing: applying modular design methodology to manage product end-of-life strategy. *Int. J. Prod. Lifecycle Manag.* **5**(2–4), 164–182 (2011). <https://doi.org/10.1504/IJPLM.2011.043186>
18. Eastwood, M.D., Haapala, K.R.: A unit process model based methodology to assist product sustainability assessment during design for manufacturing. *J. Clean. Prod.* **108**, 54–64 (2015). <https://doi.org/10.1016/j.jclepro.2015.08.105>
19. Ardente, F., Beccali, G., Cellura, M.: Eco-sustainable energy and environmental strategies in design for recycling: the software ‘ENDLESS.’ *Ecol. Modell.* **163**(1–2), 101–118 (2003). [https://doi.org/10.1016/S0304-3800\(02\)00418-0](https://doi.org/10.1016/S0304-3800(02)00418-0)
20. Ijomah, W.L., McMahon, C.A., Hammond, G.P., Newman, S.T.: Development of design for remanufacturing guidelines to support sustainable manufacturing. *Robot. Comput. Integr. Manuf.* **23**(6), 712–719 (2007). <https://doi.org/10.1016/j.rcim.2007.02.017>
21. Zheng, X., Govindan, K., Deng, Q., Feng, L.: Effects of design for the environment on firms’ production and remanufacturing strategies. *Int. J. Prod. Econ.* **213**, 217–228 (2019). <https://doi.org/10.1016/j.ijpe.2019.03.019>
22. O’Grady, P., Ramers, D., Bowen, J.: Artificial intelligence constraint nets applied to design for economic manufacture and assembly: *Comput.-Integrated Manuf. Syst.* **1**(4), 204–210 (1988). *Comput. Des.* **21**(3) 185 (1989). [https://doi.org/10.1016/0010-4485\(89\)90098-5](https://doi.org/10.1016/0010-4485(89)90098-5)
23. Schramm, A., Richter, F., Götze, U.: Life cycle sustainability assessment for manufacturing – analysis of existing approaches. *Procedia Manuf.* **43**, 712–719 (2020). <https://doi.org/10.1016/j.promfg.2020.02.115>

**Open Access** This chapter is licensed under the terms of the Creative Commons Attribution 4.0 International License (<http://creativecommons.org/licenses/by/4.0/>), which permits use, sharing, adaptation, distribution and reproduction in any medium or format, as long as you give appropriate credit to the original author(s) and the source, provide a link to the Creative Commons license and indicate if changes were made.

The images or other third party material in this chapter are included in the chapter's Creative Commons license, unless indicated otherwise in a credit line to the material. If material is not included in the chapter's Creative Commons license and your intended use is not permitted by statutory regulation or exceeds the permitted use, you will need to obtain permission directly from the copyright holder.





# **Learning and Knowledge**



# Serious Games in Academic Education – A Multi-dimensional Sustainability Analysis of Additive Versus Conventional Manufacturing Technologies in a Fictitious Enterprise Project

Christiane Rauch<sup>1</sup>, Oliver Maurer<sup>1(✉)</sup>, Sven-Erik Lang<sup>1</sup>, and Dirk Bähre<sup>1,2</sup>

<sup>1</sup> Institute of Production Engineering, Saarland University, 66123 Saarbrücken, Germany  
oliver.maurer@uni-saarland.de

<sup>2</sup> Centre for Mechatronics and Automation Technology (ZeMA), 66121 Saarbrücken, Germany

**Abstract.** Metal additive manufacturing among other advantage offers a high degree of freedom in the design of components and shortening of conventional manufacturing process chains. Hence, there are questions of technological feasibility, efficiency and sustainability. Current relevant studies, especially on the sustainability of selective laser melting, often examine only one aspect. At the same time, companies in various sectors are faced with the question of whether and if so, to what extent it is worth converting their production towards additive manufacturing units. In any case, the context is filled with complex issues in several decision-making dimensions.

In this paper, a special concept for academic education is introduced. It mirrors the complexity of decision-making issues, relevant problems and solutions, in a fictitious enterprise project named „AM for Future!?”. The project is played as a serious game with an explicit educational purpose. It is an adaptable toolbox-like game structure on a solid methodical basis. Besides clear roles with a focus on different dimensions of sustainability, it also enables variation of products and process chains. Gameplays of different project settings, spanning over three consecutive semesters, confirm the game plan as a safe environment and suitable world of experience. For research, the output of the different game seasons can be used as a simplified parameter study. This applies to objectively quantifiable as well as different qualitative approaches. These approaches influence the answer to the question of whether and, if so, how a conventional process chain can be specifically replaced and/or supplemented with metal additive manufacturing.

**Keywords:** Serious Game · Sustainability · Additive Manufacturing

## 1 Introduction and State of the Art

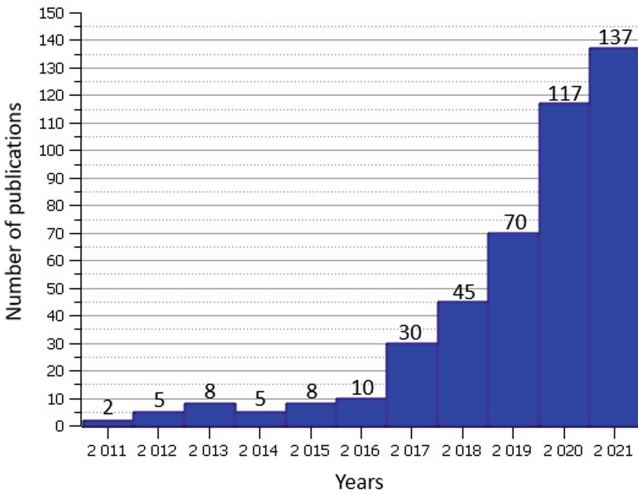
Nowadays, policies and decision-making focus more and more on ecological sustainability. This becomes evident when looking at the Green Deal of the European Union

© The Author(s) 2023

H. Kohl et al. (Eds.): GCSM 2022, LNME, pp. 819–826, 2023.

[https://doi.org/10.1007/978-3-031-28839-5\\_91](https://doi.org/10.1007/978-3-031-28839-5_91)

including major CO<sub>2</sub>-taxation. Additionally, ecological sustainability is listed in the top 4 of main goal of the European Council [1]. Societal and economic impacts of an environmental friendly transformation in technology frame ecological changes [2, 3]. Besides that, new manufacturing technologies and process chain designs emerge and allow to push the boundaries regarding geometries and product quality features. Metal Additive Manufacturing (M-AM) is a famous example in this field. Especially, Laser Powder Bed Fusion (L-PBF) increases its value for industrial application throughout numerous studies on materials, their properties and secondary effects [4]. By joining both the trends, AM and sustainability together, research output increases tremendously during the last ten years, which is shown in Fig. 1.



**Fig. 1.** Number of publications found in Web of Science on 19<sup>th</sup> April 2022 with the query “sustainability AND additive manufacturing”

There is a lack in the state of the art, regarding the wholistic approaches to the question, whether or not the L-PBF process is sustainable. Several studies focus on single aspects, acting like pieces to a bigger puzzle [5–7], whereas some papers judge L-PBF sustainable and others do the opposite. Consequently, various facts and circumstances have to be focused on to reach a final decision. Most advantages of AM in general lie in material saving potentials, reduction of storage and logistics, geometrical optimization opportunities and life-cycle performance regarding repair and adding functions to an existing part [7]. Challenges arise from the scope either only on production or on the whole life cycle [8], a lack in education, a lack in knowledge about part performance, expandable optimization in production flows [5] and high specific energies [6].

The complexity to answer the question, whether AM increases sustainability in manufacturing, advances again, if different parts or products are considered and if a second question on substitution of or supplement on conventional process chains rises. Not only is this a challenge to researchers looking for industrial use cases to study, but also for decision-makers in different industries.

Sustainability is often linked to ecological effects. However, a wholistic approach has to be multidimensional since, there are influences on economy inside an enterprise and (inter)national economics and on society in general as well as employees in a company and players in a project group [2]. A fourth optional dimension is technology itself [9].

Serious game is a term for games serving other purposes beyond entertainment. Under the guise of an entertaining game, societal or educational goals can be pursued [10, 11]. In this study, a serious game concept serves for academic education of engineering students, who participate in a simulation of the real world. The approach of matching games with learning objectives is commonly used in training of pilots, emergency medicine [11] or even in industrial environments [12]. Nevertheless, by literature research that addresses the subject specific purposes mentioned above could be found.

The Federal Institute for Vocational Education and Training in Bonn, Germany (Bundesinstitut für Berufsbildung, BiBB) acknowledges serious games as a method to assess complex issues in a safe environment and in an iterative or evolving manner [13]. Based on the information given in several references, the following list concludes the key features of a promising serious game [10–13].

- Choose an attractive topic embedded in a plausible setup.
- Define rules, assignments and goals with distinction between game production focusing on the architecture and game design focusing on in-game features.
- Choose between Rigid-Rule-Games with fixed rules and settings and Free-Form-Games with more degrees of freedom during the game or blend both types.
- Keep up with the flow and monitor the current state repeatedly
- Be careful of acquire an unbroken documentation of both game production and game design

Content and development of “AM for Future!?” are mainly based on these key features. Especially it is built up in a frame differing in basic concepts, design and production of the game [10] – with several special issues explained closer in the following.

## **2 Basic Concepts and Design of “AM for Future!?”**

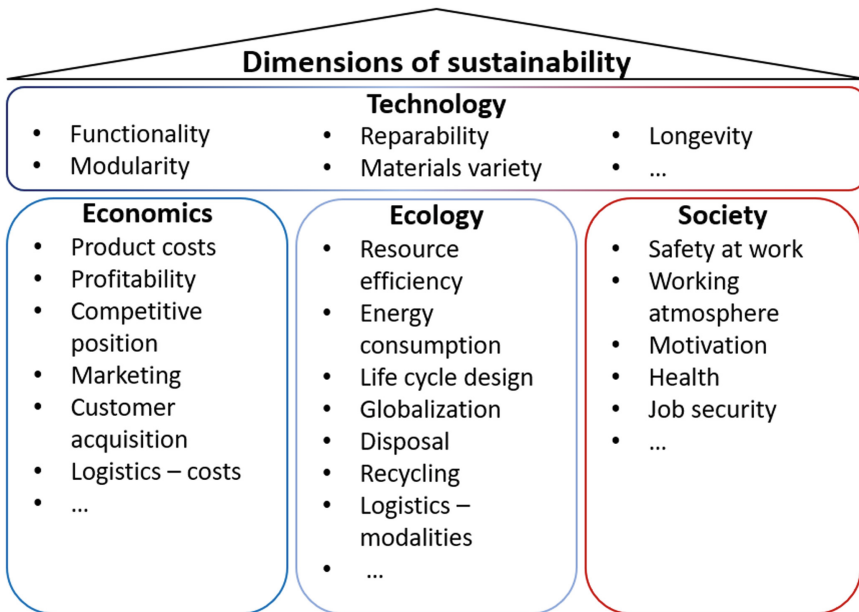
### **2.1 Basic Concepts**

The game “AM for Future!?” is played as a simulation of a project in metal industries, so one main concept is to depict a real situation in a fictitious game world as close to reality as possible. All content tasks in the game concentrate on solving the problem “switch to additive manufacturing or not, considering sustainability”. There are clearly defined learning goals with respect to the complexity of problem solving as well as the target group of master students in materials science and engineering.

The game is divided into three layers. One is the project layer in which the gaming takes place. The project has project members such as executive director, process planner and production manager, played by students. Besides that, there are two external consultants, played by two institute staff members. A suitable project management as well as competences in systems thinking, product- and process design are crucial soft skills. Therefore a “toolbox” is given as one part of the game plan. The second layer is

understanding and explaining the game design. Students and game directors interact out of their real position as learners and teachers. The third layer is the game development and further development from a meta position. All people involved in the game serve all three layers. This layered concept is mirrored in the ongoing game production with the concept of a dynamic mixture between free-form-game and rigid-rule game.

One of the most important concepts and very special in “AM for Future!?” is that each given “company role” relates to one aspect of sustainability [Fig. 2]. The executive director mainly argues from economical aspects, the process planner from ecological and the production manager from social aspects. Conflicts between the aspects resp. Their evaluation in the given production system vs. alternatives of a production with additive manufacturing are an intended part of the game. Life cycle designs, the opportunity to repair products and recycling or second life concepts contribute to a smaller environmental footprint of a product [8], but to achieve technological sustainability, the processes and operational plans have to be capable and adjusted to new cycles. Throughout game production, the role of an external technology consultant is related to basic aspects of technological feasibility. Latest research work with a rather theoretical approach came to similar conclusions [9].



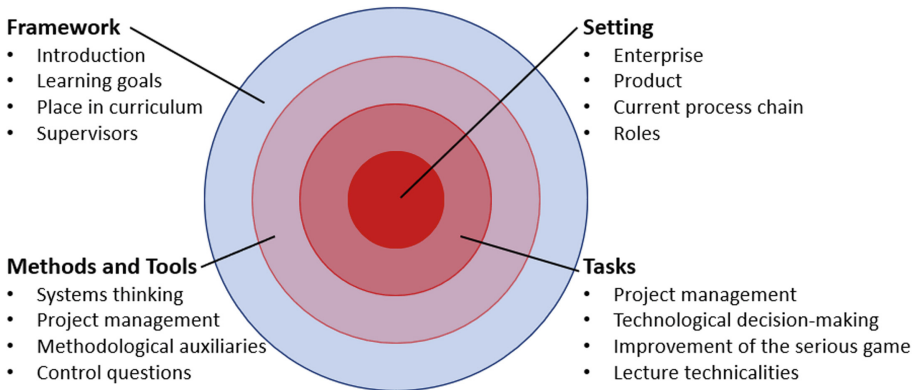
**Fig. 2.** Dimensions of sustainability as a part of the game, similar to [9]

## 2.2 Design

The design of “AM for Future!?” is summarized in Fig. 3. Main design elements are learning goals, setting, tasks and toolbox. There are learning goals related to technological and sustainability expertise and more general ones related to system design and

project work skills. In the “setting” the roles of the players are defined, product and conventional production processes are given. The “tasks” differ between the layers mentioned above: project tasks, gaming tasks and tasks to further develop the game. The design element “toolbox” represents the model and methodical base for project work. It is inspired by the systems engineering approach of Haberfellner et al. [14] and decision making in complex situations [15, 16].

Most of the design elements are described in the game plan. Besides there are several documents with technical, calculatory and other methodical information. MS TEAMS is used as digital platform for communication and cooperation as well as for ongoing documentation.



**Fig. 3.** Design elements of “AM for Future!?”

### 3 Iterative Research and Development

So far, there were three game cycles in three study semesters with a fourth iteration running. Production of the game is an ongoing process of iterative research and development, shown in Fig. 4. In the first run it was almost a free-form game with tasks not only to find solutions for a possible new sustainable manufacturing but also to set up details for the initial situation, the toolbox and the roles. From the first run to the next were changes especially in the technological focus accompanied by changes in “setting” and “tasks”. Changes in the game design are based on role and game ruling experiences as well as the factual and methodical results from previous cycles. Regular reviews are part of the development tasks. Iterative development also involves additional information packages and digital tooling. Finally, there should be a modular game structure with fixed and variable elements, more rigid-ruled, but never completely ruled, in newer versions than in previous ones.

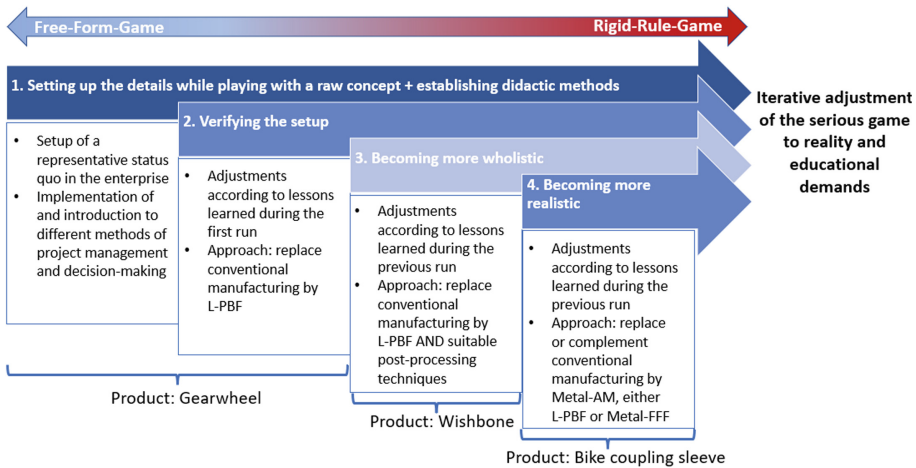


Fig. 4. Production of the game

## 4 Experiences and Results

With the experience of almost four game cycles, lots of recognitions were gained. The experiences and results are divided into two sections, a more technical one and a more methodical one.

### Concerning the question “metal-AM facing sustainability: yes/no/depending?”:

- L-PBF is only applicable from an economical point of view in high-end sectors with high requirements for geometrical complexity or aesthetic design.
- The main sticking point in ecological sustainability is powder production and consumption of electrical energy. L-PBF could be more environmental friendly, if research and industry addresses those two issues towards higher degrees of efficiency.
- Operators must face intensive training since there is no training profession in the field of AM, at least there is currently no such profession in Germany. However, jobs are rather not threatened by AM.
- Sustainability aspects raise a conflict of objectives. On the one hand, integral design is an argument pro AM due to the ability for functional integration and less joints in a product. On the other hand, for the sake of reparability, differential design is recommended. The question which design method applies in what degree, depends on each specific case.
- Evaluation strongly depends on defining systems resp. System borders (given system and the AM alternatives) and on the weight of different aspects.

### Concerning basic concepts, design and production:

- Balance between a clear setting and the freedom to follow ideas while playing is a key feature to a successful serious game in education.

- The portions of blending Rigid-Rule-Game and Free-Form-Game together can change upon iterations and should be adaptable to the audience, learning goals and tasks in a modular approach with complementary design elements.
- Game supervision should act neutral and steer only if necessary. If consultation is required, prescribe consultants into the setup.
- Expert knowledge should be available in the background and should answer the demands of a student group. Immediate access to all kinds of information overextends students and blurs the games focus.
- Always distinct between what is game related and what are technical issues. In a project meeting everyone should be clear, whether one is acting in his or her role of the serious game or whether one is being him- or herself.
- Decisions to solve the given problem(s) should be based on a mix of suitable criteria, to be calculated resp. Evaluated by a complementary mix of clear quantitative methods, expert knowledge, results of literature research and intuition of the decision-making individual and team.

## 5 Summary and Future Studies

Naming and evaluating aspects of sustainability for a technical system mostly depends on decision making in a complex surrounding. This is what it is in the serious game “Additive Manufacturing for Future!?”. Before starting the cycle of serious games, there was the literature-based idea that M-AM enhances overall sustainability of a process chain, even though some papers reject this hypothesis. Several runs of the game proved that a final answer to this question is very complex to reach. Additionally, it took these several game runs to figure out the relevance of basic technological feasibility criteria – finally leading to a fourth dimension of sustainability. Variation in system boundaries could change the project results as well as shifting the focus within the four dimensions. Monitoring on the fly and after each game run showed that learning goals were accomplished.

Future studies could cover other technical products and other constellations within the fictitious enterprise. This allows a parametric study with a variation of individual influences due to different players and different roles. Additionally, more information on how to place M-AM in industry and what kind of products it is suitable for could be gathered. Regarding the game further improvements, maybe with enhanced interdisciplinarity with expertise in the field of psychology, social sciences or didactics, could improve the game itself, its attractiveness and the reliability of scored results. On the whole, improving this serious game towards a modular system with adjustable content, helps future and present-day decision-makers educating their judgement.

**Acknowledgements.** The authors thank the European Regional Development Fund (ERDF) for supporting their research within the project numbers 14.2.1.4 – 2019/1 and 14.2.1.4/2021/1.



## References

1. European Council, A new strategic agenda for the EU 2019–2024. <https://www.consilium.europa.eu/de/eu-strategic-agenda-2019-2024/19.04.2022>
2. Villamil, C., Nylander, J., Hallstedt, S.I., et al.: Additive manufacturing from a strategic sustainability perspective (2018)
3. Chen, D., Heyer, S., Ibbotson, S., et al.: Direct digital manufacturing: definition, evolution, and sustainability implications. *J. Clean. Prod.* **107** (2015)
4. Meboldt, M., Klahn, C. (Eds.): *Industrializing Additive Manufacturing: Proceedings of AMPA2020*. Springer International Publishing, Cham (2021)
5. Ford, S., Despeisse, M.: Additive manufacturing and sustainability: an exploratory study of the advantages and challenges. *J. Clean. Prod.* **137**, 1573–1587 (2016)
6. Kellens, K., Mertens, R., Paraskevas, D., et al.: Environmental impact of additive manufacturing processes: does AM contribute to a more sustainable way of part manufacturing? *Proc. CIRP* **61**, 582–587 (2017)
7. Muthu, S.S., Savalani, M.M. (Eds.): *Handbook of Sustainability in Additive Manufacturing: Volume 2*. Springer, Singapore (2016). <https://doi.org/10.1007/978-981-10-0606-7>
8. Leino, M., Pekkarinen, J., Soukka, R.: The role of laser additive manufacturing methods of metals in repair, refurbishment and remanufacturing – enabling circular economy. *Phys. Procedia* **83**, 752–760 (2016)
9. Mörsdorf, S., Neumann, D., Mohnke, J., et al.: Beyond sustainable products – concept for a positive impact product engineering (PIPE). *Proc. CIRP* **105** (2022)
10. Dörner, R., Göbel, S., Effelsberg, W., et al. (Eds.): *Serious Games*. Springer International Publishing, New York City (2016)
11. Tatnall, A. (Ed.): *Encyclopedia of Education and Information Technologies*. Springer International Publishing, Cham (2020)
12. Müller, B.C., Reise, C., Seliger, G.: Gamification in factory management education – a case study with Lego Mindstorms. *Proc. CIRP* **26** (2015)
13. Blötz, U. (Ed.): *Planspiele und Serious Games in der beruflichen Bildung*, 5th Edition. Bertelsmann, Gütersloh (2015). Bundesinstitut für Berufsbildung
14. Haberfellner, R., De Weck, O., Fricke, E., et al.: *Systems Engineering: Fundamentals and Applications*. Birkhäuser, Basel (2019)
15. Rumeser, D., Emsley, M.: Can serious games improve project management decision making under complexity? *Proj. Manag. J.* **50**(1) (2019)
16. Attri, R., Grover, S.: Decision making over the production system life cycle: MOORA method. *Int. J. Sys. Assur. Eng. Manag.* **5**(3) (2014)

**Open Access** This chapter is licensed under the terms of the Creative Commons Attribution 4.0 International License (<http://creativecommons.org/licenses/by/4.0/>), which permits use, sharing, adaptation, distribution and reproduction in any medium or format, as long as you give appropriate credit to the original author(s) and the source, provide a link to the Creative Commons license and indicate if changes were made.

The images or other third party material in this chapter are included in the chapter's Creative Commons license, unless indicated otherwise in a credit line to the material. If material is not included in the chapter's Creative Commons license and your intended use is not permitted by statutory regulation or exceeds the permitted use, you will need to obtain permission directly from the copyright holder.





# Conversion of a Manufacturing Lab as a Learning Factory to Educate Factories of the Future Concept

Smirthya Somaskantha Iyer<sup>(✉)</sup>, Nuwan Dissanayaka, Asela K. Kulatunga,  
and Mahanama Dharmawardhana

University of Peradeniya, Peradeniya 20400, Sri Lanka  
Smirthi.iyer@gmail.com, {aselakk,mahad}@eng.pdn.ac.lk

**Abstract.** The demand for enhancing the flexibility and efficiency of the manufacturing industry has rapidly increased over the years due to mass customization to cater to the needs of society. The conventional manufacturing industry could not survive these rapid changes. Though, the manufacturing sector is the forerunner to embrace technological paradigm shift, which paves the way for Industry 4.0 or the 4th industrial revolution. With Industry 4.0, now many world leaders are moving towards a new concept called “Factories of the Future” (FoF), which predominantly engages with the cyber-physical world to digitalize manufacturing while maintaining a strong link between hardware and the cyber-physical world. To perform any manufacturing, engineering teaching/learning programs should introduce these concepts with some practical exposure, which will enable students to contribute to the manufacturing industry all around the world. Therefore, this study focuses on converting an old manufacturing lab into a learning factory to promote FoF concept. This is achieved by enabling existing manufacturing machines to be digitally connected via Industry 4.0 while creating connections with the other machines to create flexible manufacturing systems (FMS). Competencies in integrated scheduling of machine centers and autonomous material handling systems were also explored. Furthermore, the study suggested that the conversion of the manufacturing lab needs to be done in many different integration platforms.

**Keywords:** Learning Factory · Factories of the Future (FoF) · Industry 4.0 · Internet of Things (IOT) · Flexible Manufacturing System · Integrated Scheduling

## 1 Introduction

The manufacturing sector currently contributes 16% to the global GDP [1], which makes it one of the essential factors contributing to the imports and exports of any country. Given the importance of manufacturing as a source of revenue for any country, fostering excellence has become a strategic priority which makes the manufacturing industries more competitive and demanding. To cope with this highly competitive environment,

the manufacturing industry needs to be more flexible and more efficient. This furtherance in the manufacturing environment requires a technological paradigm shift that paves the way for the Factories of the Future (FoF) concept, which is enabled by Industry 4.0 or the 4th industrial revolution. The FoF concept encourages future-oriented manufacturing that implements intelligent and sustainable processes using cutting-edge digital technologies [2]. It makes creative, efficient, and optimized use of resources and energy. Industry 4.0 refers to the present trend in both professional and academic fields of industrial technology automation and data sharing, which includes cyber-physical systems, the Internet of Things (IoT), cloud computing, and cognitive computing, as well as the creation of the smart factory [3].

Industry 4.0 is based on the use of digital technology to collect and analyze data in real-time, delivering important data to the manufacturing system [4]. When it comes to developing nations, it is very difficult to acquire these state-of-the-art manufacturing facilities due to the lack of funding. As a solution to this problem, consideration was taken place to use a few old conventional manufacturing machines for this study. However, to accommodate the 4th industrial revolution and its technologies, the old manufacturing machines need to be digitalized to a certain extent for data collection and data analysis.

Before considering a full-fledged industry, to perform any manufacturing, the education sector needs to adapt and expose these cutting-edge technologies to the students for them to be able to contribute to the manufacturing industry all around the world. Therefore, the educational paradigm needs to address the emerging challenges of the manufacturing sector by practicing in an industry-relevant environment with more modern and realistic manufacturing practices called the learning factory (LF), which has facilities to learn multidisciplinary abilities, skills to synthesize, and adaptability to a variety of situations [5–8]. Even though there are many studies on the usage of industry 4.0, there are no significant studies on the conversion of old conventional manufacturing machines using Industry 4.0 technologies, especially in an LF. Therefore, this study paid particular attention to LF to educate of FoF concept.

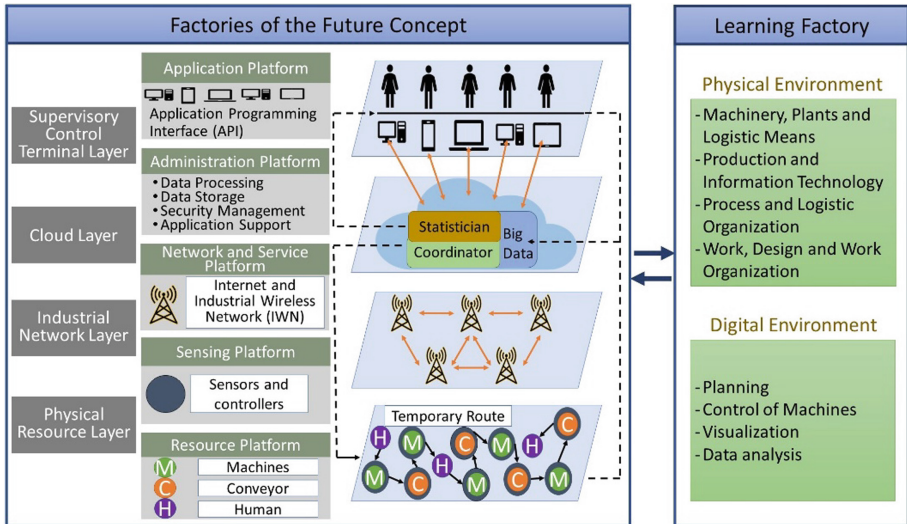
This study also explored Flexible Manufacturing Systems (FMS), competencies of integrated scheduling of machine centers, and material handling systems in a learning factory. A flexible manufacturing system facilitates flexibility of the system to improve productivity and lower the work-in-process inventory [9, 10]. Integrated scheduling in production involves scheduling, batching, and coordination of delivery decisions to achieve optimization in operational performance [11].

## 2 Methodology

### 2.1 Conversion of Conventional Manufacturing Machines to Smart Factory Using IoT

In order to convert old conventional manufacturing machines to accommodate industry 4.0 technologies, the machines should be connected to four tangible layers: the physical resource layer, industrial network layer, cloud layer, and supervisory control terminal layer [12]. These layers can be further categorized into different integration platforms

such as the resource platform, sensing platform, network and service platform, administration platform, and application platform. This system architecture is illustrated in Fig. 1.



**Fig. 1.** Framework of a smart factory in a learning factory

Ideally, the resource platform will include both human resources and machinery resources. The human resources include the students, operators, and instructors, while the machinery resources include the learning factory setups, equipment, appliances, and machines.

The sensing platform, that interconnects sensors and controllers to the industrial network layer, consists of a common interface module, communication module, and control module. The control module is capable of connecting sensors and controllers via a common connection protocol. This layer should be able to self-configure and self-adapt, which are considered the main features of the sensing layer.

The network and service platform consists of the backbone networks along with resource and administration platforms. The backbone network includes 3G, 4G networks, optical fiber networks, and Ethernet networks.

The administration platform provides means for data processing, data storage, security management, and application support. This fosters specific IoT support capabilities as in any telecommunication network layer, such as authentication, authorization, mobility management, services, applications, users, and developers.

The application platform provides a common function and an open application programming interface (API). With the aid of the API, users could publish information to the application platforms.

For a digitalization process, information transparency is important. The available data needs to be identified and then converted into accessible data with the aid of sensors and measurement devices. Furthermore, the data needs to be converted into active data,

which is real-time data. The final step is to transform data into action-oriented data, which can be used in optimization algorithms, deep learning, and big data analysis.

During the process of transforming accessible data into active data, sensors will be connected to a network through interfacing devices. Then, a visualization method will be implemented to access the data. Next, a further transformation of accessible data into active data will be done by enabling real-time monitoring through the visualization method. When using these data for performance optimization, efficiency improvement, extending capabilities, reducing downtime and machine lifetime widening these data will become actionable data.

## **2.2 Flexible Manufacturing System (FMS) and Material Handling System**

An FMS can have different forms of flexibility, such as process flexibility, material handling flexibility, machine flexibility, operation flexibility, product flexibility, routing flexibility, volume flexibility, expansion flexibility, production flexibility, and control program flexibility [10]. For an FMS setup, to accommodate any of these flexibilities, all the machines need to be able to communicate with each other. The common information that is needed to implement these flexibilities is the status of the machine processing. Using the smart factory approach, sensors can be installed to get the status of the machining process. To communicate this information with the other machines, IoT-enabled hardware needs to be installed to create a wireless sensor network. This can be done with wireless sensor network hardware and technology such as Zigbee and Xbee. With its low power, low data rate, low cost, and short time delay characteristics, Zigbee is one of the most widely used Wireless Sensor Network standards. It is also easy to develop and deploy, offers strong security, and has high data reliability. Xbee is a module that uses a radio communication transceiver and receiver which supports Zigbee protocol. It has a source/destination addressing feature with unicast and broadcast communication support which supports point-to-point, point-to-multipoint, peer-to-peer, etc. communication topologies.

The mismanagement of the materials and logistics can reduce productivity and efficiency. Therefore, good material management should be implemented, which involves planning and controlling the quantity of the materials, punctuality of the placement of materials and equipment, and delivery of the right quantity. To manage the material handling system, an automatic guided vehicle (AGV) can be used. The AGV also should be able to access the machine process status information. Therefore, the AGV should have a communication protocol method to be able to receive the information from the wireless sensor network. This communication can be established using serial communication or through software applications such as Robot Operating System (ROS). ROS is an open-source framework that helps researchers and developers in creating and reusing code for robotics applications such as an AGV.

## **3 Case Study**

So far, the work presented focuses on concept definition. Concept implementation will be part of an ongoing and future collaborative project work. The implementation approach is shortly discussed in the following paragraphs.

The Department of Manufacturing and Industrial Engineering (DMIE), University of Peradeniya, Sri Lanka, has a few old conventional manufacturing machines which needed to be digitalized and IoT enabled to create a smart factory and a learning factory. In addition, due to the Covid-19 pandemic, globally, there was a paradigm shift in the method of education. All the classes and practical sessions were obliged to be conducted online. Due to this reason, there was a need for the academic staff and the students to access and control the machines remotely. Therefore, the conversion of the conventional manufacturing machines to a smart factory concept was implemented in a Computer Integrated Manufacturing (CIM) center, which consists of an RH-M2 Mitsubishi robotic arm.

The controller of the robot arm was connected to a control PC via an RS232 interface. A Wi-Fi module (ESP 8266) was connected to the PC via a USB port, and then it was interconnected to the PC and the cloud database through the network layer. Values updated in the real-time database were sent to the control PC via network layer using ESP 8266. With the aid of real-time data, commands were obtained, and the robot arm was controlled online. A camera is installed to view the movements of the robot arm. The connection of the robotic arm is illustrated in Fig. 2.

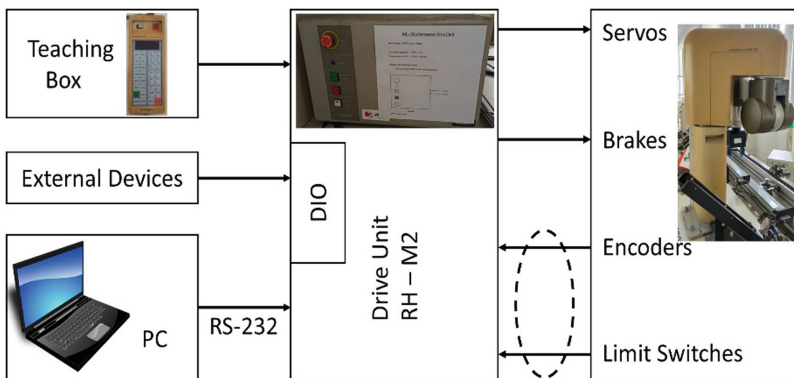


Fig. 2. Connection of the robotic arm to obtain the real-time data.

To interact, code, control, and view the movements of the robotic arms in the CIM center, a dashboard was created named 'Smart DMIE', which was named after the Department of Manufacturing and Industrial Engineering (DMIE). The Smart DMIE interface enabled the students and the instructors to conduct laboratory sessions online in real-time without physical participation. The dashboard programming panel allows students to remotely write programs and execute them to control machinery and button controllers (see Fig. 3). The dashboard also displayed the collected data on a graph to analyze the data conveniently.

To create the Smart DMIE dashboard, web-based applications and languages were used. To handle the request from the user, a back-end JavaScript runtime environment, 'Node.js', was used. Node.js is an open-source, cross-platform, and executes JavaScript code outside of a web browser. It helps to create scalable network applications. In this

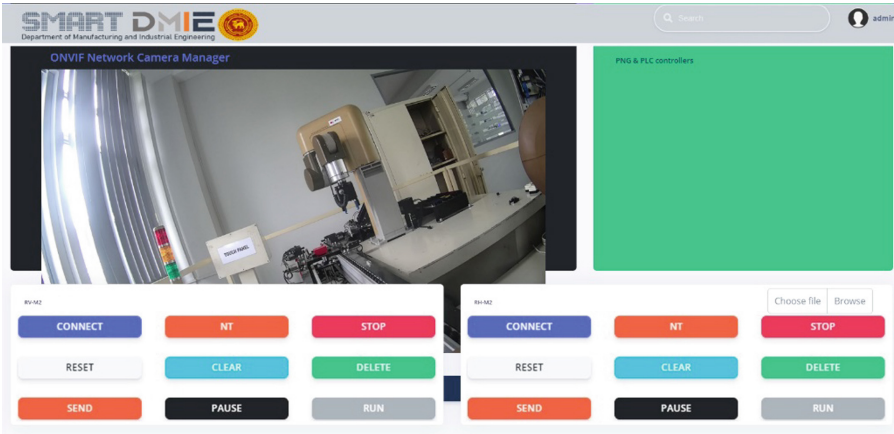


Fig. 3. 'Smart DMIE' online dashboard.

case, Node.js controls the server and collects data asynchronously which makes it a faster connection. To define, manipulate, retrieve, and manage data, 'PostgreSQL' was used as a database. PostgreSQL, also known as Postgres, is an open-source object-relational database system that utilizes and extends the SQL language to safely store and manage complex data workloads. To bridge Node.js and Postgres database, 'Express.js' was used. Express.js is an open-source web application framework for Node.js which can program web apps that can be launched using a web browser. It is mainly used to design and construct web applications quickly and easily. Figure 4 illustrates the software architecture that was used to create the Smart DMIE dashboard.

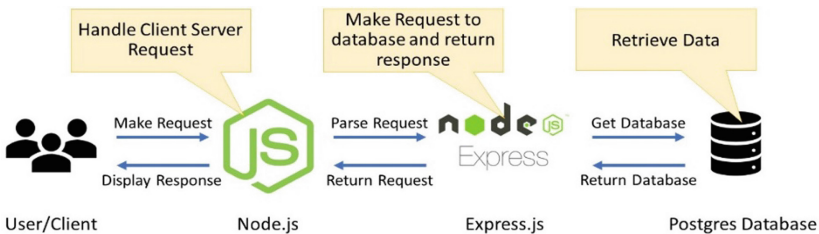


Fig. 4. 'Smart DMIE' dashboard web-based application and language architecture

Comparing the case study and the conceptual framework of a smart factory in an LF, the human interaction and the robot are considered the resource platform. The camera that is fixed to view the robot movements and the servos and encoders in the robot comes under the sensing platform. The usage of the Wi-Fi module (ESP 8266) connects the set-up to the network and service platform. The usage of the Postgres database is considered the administration platform. Finally, the usage of Node.js and Express.js acts as the application platform. Since the Smart DMIE dashboard was implemented in an

academic environment with many ongoing research and education on realistic manufacturing, it supports the learning factory concept. It is evident that industry 4.0 technologies have been used by introducing the Smart DMIE dashboard that uses cutting-edge technologies to revolutionize and improve manufacturing capabilities. Not only that, the Smart DMIE supports future-oriented manufacturing that uses advanced technologies such as IoT, cloud computing, cognitive computing, and real-time virtualization. Based on this preliminary assessment, and the acquisition of high-quality and relevant manufacturing data from the Smart DMIE dashboard project, it has been identified that the implementation of the conceptual framework is successful.

The future work of this project is to develop the digital twin (DT) enabled dashboard or to create a realistic 3D visualization approach to demonstrate DT. The conversion of the conventional machines can be implemented in all the other machines in the learning factory to enable FMS and AGV-enabled material handling systems.

## 4 Results and Discussion

After the conversion of the conventional manufacturing lab using the help of the four tangible layers and five integration platforms, to a certain extent, the machines can be used to perform advanced and latest manufacturing techniques in a classroom environment which makes it an LF. Implementing these layers and platforms uses the technologies such as cyber-physical systems, IoT, cloud computing, and cognitive computing therefore, it makes it an industry 4.0-enabled environment. Not to mention, the usage of these cutting-edge technologies and implementation of FMS and integrated scheduling allows it to perform futuristic manufacturing which promotes the FoF concept.

## 5 Conclusion

This study focused on the conversion of traditional manufacturing machines to a learning factory to promote factories of the future concept. This is achieved by enabling existing manufacturing machines to be digitally connected via industry 4.0 and by creating a flexible manufacturing system.

In this paper, the concept of how to convert conventional manufacturing machines to a smart factory using IoT and the concept of creating an FMS with AGV enabled material handling system was explored. The study suggested that the conversion can be done in five different integration platforms: resource platform, sensing platform, network and service platform, administration platform, and application platform. To create an FMS, many machines can be digitalized and enable IoT to communicate through a wireless sensor network. To create a material handling system, AGV can be connected to all the machines using serial connections or communication software such as ROS.

An ongoing project at a learning factory at the Department of Manufacturing and Industrial Engineering (DMIE), University of Peradeniya, Sri Lanka, proved that the conversion of the conventional manufacturing machine to a smart factory was successfully implemented. It is also noted that there can be some limitations to the project presented in the paper. Since the machines enable to be controlled online, security can be a threat to this system. Not only that, the sensor that needs to be installed at the sensing



platform varies from machine to machine. Also, the sensors need to be calibrated and once again, the calibration can vary from machine to machine. Therefore, a generic method of implementation of the sensors and sensor calibration cannot be obtained. Though, this study also proved to have advantages such as conducting the laboratory classes remotely. Using existing manufacturing machines to implement futuristic technologies makes it sustainable manufacturing. Even though there are a few drawbacks to the study, ultimately, the implementation of the suggested framework and the subsequent validation of the expected benefits will be part of future work.

## References

1. Manufacturing, value added (% of GDP) | Data, data.worldbank.org (2020). <https://data.worldbank.org/indicator/NV.IND.MANF.ZS?end=2020&start=2000>. Accessed 05 May 2022
2. Jardim-Goncalves, R., Romero, D., Grilo, A.: International journal of computer integrated manufacturing factories of the future: challenges and leading innovations in intelligent manufacturing. *Comput. Integr. Manuf.* **30**, 4–14 (2016). <https://doi.org/10.1080/0951192X.2016.1258120>
3. Frank, A.G., Dalenogare, L.S., Ayala, N.F.: Industry 4.0 technologies: implementation patterns in manufacturing companies. *Int. J. Prod. Econ.* **210**(210), 15–26 (2019). <https://doi.org/10.1016/j.ijpe.2019.01.004>
4. Lee, J., Bagheri, B., Kao, H.-A.: A cyber-physical systems architecture for industry 4.0-based manufacturing systems. *Manuf. Lett.* **3**(1), 18–23 (2015). <https://doi.org/10.1016/j.mfglet.2014.12.001>
5. Elbestawi, M., Centea, D., Singh, I., Wanyama, T.: SEPT learning factory for industry 4.0 education and applied research. *Procedia Manuf.* **23**, 249–254 (2018). <https://doi.org/10.1016/j.promfg.2018.04.025>
6. Böhner, J., Scholz, M., Franke, J., Sauer, A.: Integrating digitization technologies into resource efficiency driven industrial learning environments. *Procedia Manuf.* **23**, 39–44 (2018). <https://doi.org/10.1016/j.promfg.2018.03.158>
7. Abele, E., et al.: Learning factories for research, education, and training. *Procedia CIRP* **32**, 1–6 (2015). <https://doi.org/10.1016/j.procir.2015.02.187>
8. Wagner, U., AlGeddawy, T., ElMaraghy, H., Mÿller, E.: The state-of-the-art and prospects of learning factories. *Procedia CIRP* **3**, 109–114 (2012). <https://doi.org/10.1016/j.procir.2012.07.020>
9. Kaighobadi, M., Venkatesh, K.: Flexible manufacturing systems: an overview. *Int. J. Oper. Prod. Manag.* **14**(4), 26–49 (1994). <https://doi.org/10.1108/01443579410056029>
10. Manu, G., et al.: Flexible manufacturing systems (FMS), a review. *Int. J. Mech. Prod. Eng. Res. Dev.* **8**(2), 323–336 (2018). <https://doi.org/10.24247/ijmperdapr201836>
11. Zhong, X., Jiang, D.: Integrated scheduling of production and distribution with release dates and capacitated deliveries. *Math. Probl. Eng.* **2016**, 1–5 (2016). <https://doi.org/10.1155/2016/9315197>
12. Wang, S., Wan, J., Zhang, D., Li, D., Zhang, C.: Towards smart factory for industry 4.0: a self-organized multi-agent system with big data based feedback and coordination. *Comput. Netw.* **101**, 158–168 (2016). <https://doi.org/10.1016/j.comnet.2015.12.017>

**Open Access** This chapter is licensed under the terms of the Creative Commons Attribution 4.0 International License (<http://creativecommons.org/licenses/by/4.0/>), which permits use, sharing, adaptation, distribution and reproduction in any medium or format, as long as you give appropriate credit to the original author(s) and the source, provide a link to the Creative Commons license and indicate if changes were made.

The images or other third party material in this chapter are included in the chapter's Creative Commons license, unless indicated otherwise in a credit line to the material. If material is not included in the chapter's Creative Commons license and your intended use is not permitted by statutory regulation or exceeds the permitted use, you will need to obtain permission directly from the copyright holder.





# Evaluation of Competencies for a Sustainable Industrial Environment

G. Campana<sup>1</sup>(✉), M. Mele<sup>1</sup>, L. De Bortoli<sup>1,2</sup>, B. Cimatti<sup>1</sup>, and H. Kobayashi<sup>2</sup>

<sup>1</sup> Department of Industrial Engineering, University of Bologna, Viale Risorgimento 2,  
40136 Bologna, Italy  
giampaolo.campana@unibo.it

<sup>2</sup> Department of Mechanical Engineering, Osaka University, 2-1, Yamadaoka, Suita 565-0871,  
Osaka, Japan

**Abstract.** The organisation of worker activities in manufacturing shops have been differently conceived depending on political, societal, environmental and economic circumstances affecting industrial development. From Taylorism and Fordism through Lean Manufacturing to the innovative Cell Production system, the level and quality of abilities and competencies of workers have increasingly become the kernel of factory management models. Sustainability has increasingly become a crucial factor for product success. The design and manufacture of industrial products are conceived in circular loops within the 6R framework. The digitalisation of information has allowed significant advancements. Qualified and skilled operators have accompanied and led these evolutions, and their abilities and creativity have grown relevant, despite the continuous increase in automation.

This work investigates the contribution of craftsmanship abilities in the industrial environment. For this purpose, the Craftsmanship Index has been proposed to assign a quantitative value to the craftsmanship skills contributing to the manufacturing activities. A customised questionnaire to be administered to workers is used to calculate this index, which is helpful to analyse worker abilities and the way they are learned and developed, being part of effective management and decision-making tools. A case study in the Japanese manufacturing environment expands on previous results achieved in Italy.

The Craftsmanship Index allowed us to give a quantitative relevance to the level of abilities of operators depending on the analysed department. Some cultural differences have also emerged thanks to the comparison between the Japanese and the Italian culture.

**Keywords:** Industry 4.0 · Craftsmanship · Cell Production · Lean Manufacturing · Intangible Assets

## 1 Introduction

Craftsmanship has always contributed to the structure of production processes. From traditional to mass production, modern industry has always aimed to reduce human intervention in production, in order to speed up times and reduce costs, with an increasing use of machines and automation at the expense of labour, to guarantee products with

certain quality standards. Both Taylorism and Fordism present the idea of employing a workforce that uses machines to do the job: workers do not actively participate in the manufacture of the product, but their actions are limited to the use of machinery. With the introduction of the Toyota Production System and Lean Manufacturing, the man comes back to the centre of the factory: workers are required to be able to use machines, acquire specialist skills and participate in the entire lean factory approach in terms of initiative and flexibility. The skills and competencies required are even more important in the modern Cell Production systems, where the operator knows how to carry out all the tasks related to a product [1, 2]. In addition to today's economic crisis, the increase in competitiveness by emerging economies combined with environmental and social considerations have undermined the paradigms of mass production and scientific standardization, re-evaluating the possibility of an economic scenario in which craftsmanship returns to be the protagonist of growth and innovation. The revolution of Industry 4.0 is radically transforming workers' job and competence profiles. It is therefore necessary to implement appropriate training strategies and to organise work in a way that fosters learning, enabling lifelong learning and workplace-based Continuing Professional Development [3].

Production systems have shifted from mass production to mass customisation: personalised, customised products that present different characteristics for different customers. Mass Customisation (MC) has emerged as a practice that combines the best of the craft era with the best of the mass production era [4]. Many companies have been able to mix scientific knowledge and tradition, learning to communicate the skills of master craftsmen through new communication channels. It is just about using the potential of craftsmanship to create value added to a product [5]. Craftsmanship implies the production and delivery of high-quality products or services performed by highly qualified and competent operators. It can be combined with the most modern technologies, still being a synonymous with innovation and customization. But skilled workers also increase sustainability: environmental, with "clean" production cycles combined with longer life cycles; economic, social and institutional, generating new jobs and improving manufacturing quality [6]. Fyhn and Søråa use a slightly different model where the economic aspect is replaced with "cultural sustainability". Also, this adheres to the definition: "capable of being maintained or continued", as it has to do with the craft's ability to sustain a knowledge-tradition and practice into the future in terms of having sustainable communities of practice bringing forward a certain level of skills in building. They do so by changing and adapting these skills to match a transforming reality [7].

In a context in which craftsmanship confers characteristics of uniqueness, added value and sustainability to the product and the process, it is necessary to determine an approach that goes beyond the limits that companies are facing today in this sense, and that takes into account how this intangible asset quantitatively and qualitatively affects the business system [8]. Intangible resources have steadily increased over the years, reaching very high percentages (over 40% of total assets in high-tech sectors) in industrialized economies. This rise of the intangible economy could play an important role in explaining secular stagnation. Over the past 20 years, there has been a steady increase in the importance of intangible investments relative to tangible investments: by

2013, for every £1 investment in tangible assets, the major developed countries spent £1.10 on intangible assets [9].

Intangibles (such as human, structural and relational capital) are difficult and expensive to be measured. The main problem with this kind of measurements is that it is not possible to measure social phenomena with anything close to scientific accuracy [10]. However, some models have been proposed to provide a qualitative evaluation, which is often globally recognized. These models attempt to quantify the company's human, structural and relational capital to convert them into accounting and financial terms. Conversely, other models attempt to quantify these resources more strategically. To date, no models for quantifying intangible assets referring to the level of craftsmanship and skills used in the manufacturing process of an industrial product have been proposed.

In this work, the evaluation of artisanal competencies relevance within the industrial environment is carried by means of a method that has been developed in previous studies [9]. It is based on a specific questionnaire that is administered directly to the workers and on the calculation of the Craftsmanship Index, CI. In particular, the proposed methodology has been customised to be applied to the Japanese manufacturing context. It allowed us to customise the implementation of the proposed methodology to Japan. The proposed approach and the related questionnaire utilised for the evaluation are introduced in Sect. 2. The obtained results are presented and discussed in Sect. 3.

## 2 Evaluating Craftsmanship in Industrial Environment

This section deals with the methodology (Sect. 2.1), the structure of the questionnaire (Sect. 2.2) and its implementation to the Japanese context (Sect. 2.3).

### 2.1 Proposed Methodology and Previous Studies

The artisan contribution to an industrial product contributes to providing added value for the customer, in terms of characteristics such as uniqueness, quality, innovation, and sustainability. A focus on employee characteristics such as behaviour or cognitions is relevant not only because it can yield important individual outcomes related to wellbeing, but also because such characteristics benefit organisations. Job crafting is a promising yet relatively unexplored approach [11] that, potentially, employees can use to heighten their job satisfaction and wellbeing [12].

Operators develop skills and competencies thanks to natural characteristics, personal predisposition and vocation, as well as influenced by the surrounding cultural and/or work environment. In the Italian development, skills are the abilities that are innate and competencies are acquired through training activities.

The general methodology proposed by [9, 12] is based on the CI that describes the performance of manufacturing operators based on four factors: (a) craft skills,  $F_{Cfts}$ ; (b) creativity skills,  $F_{Cvt}$ ; (c) culture, history and tradition,  $F_{CHT}$ ; (d) influence of territorial vocation,  $F_{Tv}$  (Eq. 1).

$$CI = \frac{\sum_{i=1}^4 w_i F_i}{\sum_{i=1}^4 w_i} = \frac{w_1 F_{Cfts} + w_2 F_{Cvt} + w_3 F_{CHT} + w_4 F_{Tv}}{\sum_{i=1}^4 w_i} \quad (1)$$

Craft skills refer to the acquired competencies, which a worker learns during his working life. An apprenticeship is necessary, while passion is useful but not necessary. Creativity skills are related to the natural skills and predispositions, which every person has that, once linked to the acquired competencies, can lead to better performance. Culture, history and tradition can influence human activities and how people interact with tasks in the work context. Territorial vocation may influence as well, in terms of availability of natural resources and other features. Most of these points, mainly concerning cognitive processes, concur to attribute intangible characteristics to the product and are difficult to be quantified. However, they can be effectively defined qualitatively. The number of owned skills and competencies is significant and represents a competitive factor for certain kinds of manufacturing enterprises: a more skilled and competent worker or employee can be evaluated as a competitive advantage. As a consequence, the proposed index can also be useful to an enterprise to understand how to acquire skills and competencies to foster positive development.

The CI is calculated as a weighted sum of the four factors above, as shown in Eq. 1. Weights  $w_i$  vary according to the production context and societal issues being studied. The application of the CI requires a broad and in-depth study of the industrial context and societal issues. Information regarding crucial aspects of the product manufacture, such as production processes, in terms of their phases and operators' skills, as well as the manufacturing context features (points of strength and weakness), the industrial structure and the market. The chosen approach is to consider the production process and the skills required at each phase of it together with the competencies that the operator possesses to perform the operations.

The methodology used to investigate the operators' natural skills and acquired competencies requires designing a questionnaire based on a set of "closed" questions to collect information on the qualitative and quantitative variables being investigated [12, 13]. The measuring method proposed includes tools through which the interviewee identifies the answers closest to an ideal position agreed between the management and the experts of the considered process. This allows to quickly involve a large number of people to gather information, to know opinions, attitudes, and intentions. With careful planning, questionnaires can yield high-quality usable data, achieve good response rates and provide anonymity, the latter encouraging more honest and frank answers, than for example interviews. This can help to reduce bias [13]. Well-constructed questionnaires can contribute to a deeper understanding of job characteristics, craft skills and the context in which they are applied. Therefore, the questionnaire proposed in this paper consists of a self-evaluations by the operators, who express their opinion about how their own skills and competencies are learnt and developed and how they contribute to obtaining the finished product.

## 2.2 Details About the Questionnaire Structure

The questionnaire has a structure which is functional to the research aim. It is divided into three parts that possess the same structure. The three parts of the questionnaire are described below in detail:

- (1) “*Personal Data and details*”, consists of the personal details of respondents, including gender, age, and education level. Also, information concerning the work activity, the position, the department, and the interaction of the worker with other departments have been investigated. This part is composed of 2 questions.
- (2) “*Mapping Competencies and Skills*”, concerns the skills and competencies acquired in the specific work context, their nature, and their development. Generally, skills require specific training to be acquired. However, sometimes they can be acquired by self-learning. This part also investigates how the operator’s work is carried out, whether the machinery is used, and what factors have the greatest influence on the quality of the finished product. This part consists of 35 questions.
- (3) “*Job Characteristics and Work Context*” refer to the characteristics of the work context and to the generalized work activities, common to several jobs that must be adapted to the particular context. The influence of the socio-cultural context is the focus of this part. This part is composed of 6 questions.

Each question of the questionnaire is organised in sections and levels and has a set of possible choices based on a Likert scale, in order to let the respondents have more chances to choose. The main advantage of using this measurement system is that it is a numerical scale and it’s therefore easily convertible in quantitative terms: replacing each judgment with a numerical score, allows us understanding the position of the person on the concept investigated. It collects the opinions of the workers about their job and it gives appropriate weights to them.

Weights are associated with each question. Higher weights have a greater influence on the calculation of the index, therefore they refer to aspects considered more significant for the purpose of calculating the CI. A crucial point is the assessment of the weights that must correspond to the relevance of the considered skills in a certain industrial context. A number of scenarios were examined for their determination, and a proposal has been made based on previous industrial experiences with the necessary participation of the enterprise management in the process.

### **2.3 Implementation of the Questionnaire to the Japanese Context**

The questionnaire was translated into Japanese to be administered to the operators of the Japanese industrial sector of hydraulic pumps. It has been modified according to the Japanese industrial culture and context. The original weights, which were applied in previous case studies, have been redesigned together with the enterprise management. Three departments of the same enterprise were considered.

In total 60 questionnaires, each composed of 43 questions were prepared.

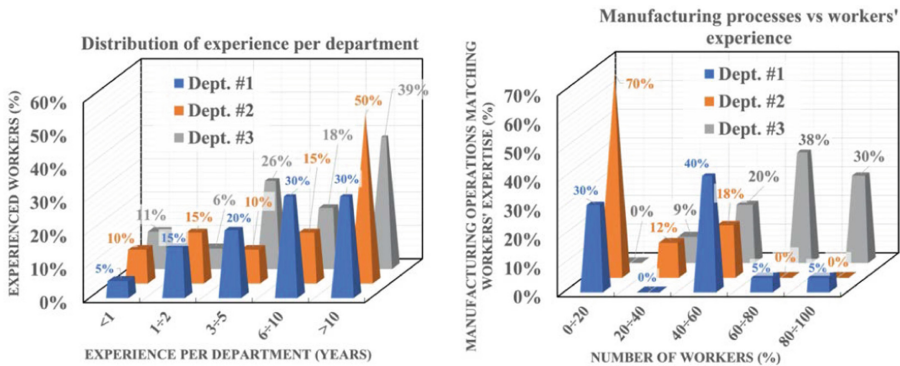
All the 60 respondents returned the questionnaire, with a return rate of 100%. This number can be considered valid to carry out a statistical analysis. All the data were collected and analysed and are presented in a grouped form in Sect. 3.

## **3 Results and Discussion**

The data gathered from the survey have been elaborated to calculate the CI. Several graphical elaborations have been done, to analyse and explain the main result of the

present investigation. The application of the proposed method to a specific industry, geographical and cultural context has allowed us to identify some peculiar differences between the Japanese and the Italian cultural contexts that can significantly influence the definition of the CI. As an example, in the Japanese industrial environment, natural skills are not admitted. Instead, experience and devotion are considered necessary and sufficient to achieve and reach the best performance to fulfil the assigned task.

In Fig. 1 the percentage of experienced workers per each considered department and the percentage of production processes able to carry out by workers per each considered department are shown. It is worth underlining that a larger percentage of experienced workers are employed in each department and that their distribution is almost the same in all the examined manufacturing departments. The situation is different if examining the ability of operators in each department. In particular, it is possible to remark that Dept. #2 presents a fragmentation of the activities with workers that are directly able to carry on no more than one-fifth of the operations. On the opposite, in Dept. #3 some operators control the entire manufacturing cycle of products. Dept. # 1 has an intermediate configuration with some operators that can lead more than the 50% of the manufacturing activities.

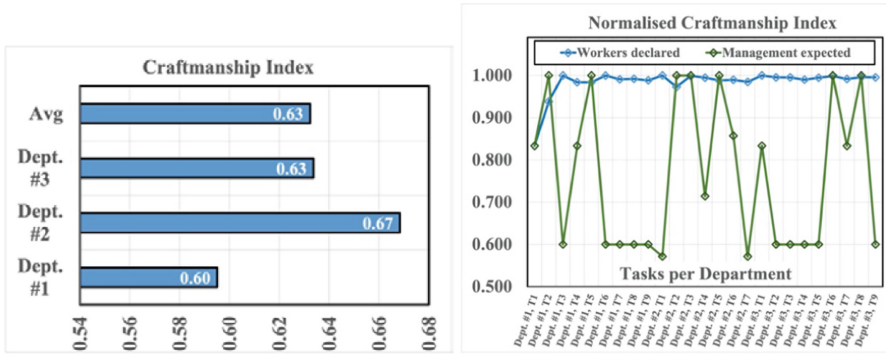


**Fig. 1.** (left) Percentage of experienced workers per department. (right) Percentage of manufacturing processes matching workers' expertise by department.

Figure 2 shows the calculated normalised CI (left side). Higher values of this index mean that more advanced skills and competencies are needed. The higher value was calculated for the Dept. # 2 and the lower value for the Dept. # 1. Dept. # 2 utilizes CNC tools to machine the process components. Despite being the department with more automation and less manual work, there are many skills and abilities required, such as understanding a technical drawing, developing an NC program and knowing how to use the machinery. A higher value was expected for the other departments, where hand work is more used in terms of time-consuming activities. A possible explanation is the high specialisation and fragmentation of the competencies within the Dept. #2 (see Fig. 2, right side) that helps to make each task simpler and achieve higher productivity. Special attention is needed to assure that all the operators can develop the required skills.

A comparison between workers perceptions about the relevance of the tasks they are responsible for and management expectations has also been considered. The data





**Fig. 2.** (left) Calculated normalised CI. (right) Normalised CI per dept. Per task: expected (management) and perceived (workers).

provided by managers concerning all the weights associated with each task describing its relevance within each department are used to calculate an index expectation. A comparison between the expected importance of each task from the management perspective and the declared relevance from the worker perspective is shown in Fig. 2, right side. A discrepancy is clearly visible between the operators’ perception of their duties and the manager’s expectations. This result highlights the tendency of underestimating what is considered relevant for the workers. It can be helpful to promote a better alignment between operator perception and manager expectation to understand the importance of each task and take the necessary measures to develop the appropriate skills.

### 4 Conclusion

The aim of this paper is to investigate the artisan contribution to the manufacturing process of a product in the industrial environment. The CI, which has been proposed previously, has been applied and extended within a case study carried on in the Japanese industrial sector of hydraulic pumps to analyse how artisan skills and competencies are learned, developed and applied. A questionnaire has been designed and administered to operators working in the manufacturing departments. It investigates the artisan skills at a strategic level, from their acquisition up to their development over time.

The assignment of weights to the different components of the index is a crucial point of the analysis. There are no objective assignment criteria, the weights must be defined considering appropriate scenarios and agreed with the management and experts.

The CI comparison between workers and managers concerning their understanding of the value of each operative task has been made leading to the awareness that the perceptions of the operators and those ones of the managers are different. In particular, managers often underestimate the value of tasks in comparison with the perception of workers.

The proposed methodology can be applied to different industrial and manufacturing contexts. It can be used to distinguish and classify companies based on the quality and contribution given by the craftsmanship and skills exploited in their production systems.

The CI can allow the estimation of how craft skills are learned and developed. This index can be part of effective management and decision-making tools. The extension to the Japanese industrial environment has allowed identifying some similarities and differences between the Japanese and the Italian industrial contexts and confirmed the general validity of the proposed approach.

All the data, in a grouped form, are available on request.

## References

1. Zwierzyński, P., Ahmad, H.: Seru production as an alternative to a traditional assembly line. *Int. Soc. Manuf. Serv. Manag. Eng.* **10**(3), 62–69 (2018)
2. Micelli, S.: *Futuro Artigiano: l'innovazione nelle mani degli italiani*, Marsilio editori (2011)
3. Acatech. Recommendations for implementing the strategic initiative INDUSTRIE 4.0. (2013)
4. Fralix, M.T.: From mass production to mass customization. *J. Text. Apparel Technol. Manag.* **1**(2), 1–7 (2001)
5. Campana, G., Cimatti, B.: The slow factory: a new paradigm for manufacturing. In *Proceedings of the Global Conference on Sustainable Manufacturing*, pp. 273–277. Berlin (2013)
6. Hapuwatte, B.M., Badurdeen, F., Jawahir, I.S.: Metrics-based integrated predictive performance models for optimized sustainable product design. In: Campana, G., Howlett, R., Setchi, R., Cimatti, B. (eds.) *Sustainable Design and Manufacturing 2017. SDM 2017. Smart Innovation, Systems and Technologies*, vol. 68, pp. 25–34. Springer, Cham (2017). [https://doi.org/10.1007/978-3-319-57078-5\\_3](https://doi.org/10.1007/978-3-319-57078-5_3)
7. Fyhn, H., Søråa, R.A.: Craftsmanship in the machine: Sustainability through new roles in building craft at the technologized building site. *Nordic J. Sci. Technol. Stud.* **5**(2), 71–84 (2017)
8. Merler, S.: *Economy of Intangibles. Finance & Financial Regulation* (2018). Bruegel.org
9. Cimatti, B.G., Campana, G.: Measures and methods for a new taxonomy in manufacturing enterprises. *CIRP Procedia* **26**, 287–292 (2015)
10. Slempt, G.R., Vella-Brodrick, D.: The job crafting questionnaire: a new scale to measure the extent to which employees engage in job crafting. *Int. J. Wellbeing* **3**(2), 126–146 (2013)
11. Tims, M., Bakker, A.B., Derks, D.: Development and validation of the job crafting scale. *J. Vocat. Behav.* **80**(1), 173–186 (2012)
12. Campana, G., Cimatti, B., Melosi, F.: A proposal for the evaluation of craftsmanship in industry. *Procedia CIRP* **40**, 668–673 (2016)
13. Marshall, G.: The purpose, design and administration of a questionnaire for data collection. *Radiography* **11**(2), 131–136 (2005)

**Open Access** This chapter is licensed under the terms of the Creative Commons Attribution 4.0 International License (<http://creativecommons.org/licenses/by/4.0/>), which permits use, sharing, adaptation, distribution and reproduction in any medium or format, as long as you give appropriate credit to the original author(s) and the source, provide a link to the Creative Commons license and indicate if changes were made.

The images or other third party material in this chapter are included in the chapter's Creative Commons license, unless indicated otherwise in a credit line to the material. If material is not included in the chapter's Creative Commons license and your intended use is not permitted by statutory regulation or exceeds the permitted use, you will need to obtain permission directly from the copyright holder.





# Federated Learning for Privacy-Preserving Collaboration in Smart Manufacturing

Jianjing Zhang, Clayton Cooper, and Robert X. Gao<sup>(✉)</sup>

Case Western Reserve University, Cleveland, OH 44106, USA

Robert.Gao@case.edu

**Abstract.** Manufacturers today are increasingly connected as part of a smart and connected community. This transformation offers great potential to deepen their collaborations through resource and knowledge sharing. While the benefits of artificial intelligence (AI) have been increasingly demonstrated for data-driven modeling, data privacy has remained a major concern. Consequently, information embedded in data collected by individual manufacturers is typically siloed within the bounds of the data owners and thus under-utilized. This paper describes an approach to tackling this challenge by federated learning, where each data owner contributes to the creation of a global data model by computing a *local* update of relevant model parameters based on its own data. The local updates are then aggregated by a central server to train a *global* model. Since only the model parameters instead of the data are shared across the various data owners, data-privacy is preserved. Evaluation using sensor data for machine condition monitoring has shown that the global model produced by federated learning is more accurate and robust than the local models established by each of the single data owners. The result demonstrates the benefit of secure information sharing for individual manufacturers, especially Small and Mid-Sized Manufacturers (SMMs), for improved sustainable operation.

**Keywords:** Smart manufacturing · Federated learning · Data privacy

## 1 Introduction

Smart and connected technologies, such as multimodal sensing, Internet of Things (IoT), and artificial intelligence (AI), have demonstrated potential in transforming the landscape of manufacturing toward improved productivity and the overall well-being of the community in which manufacturers reside [1]. However, for many Small and Mid-Sized Manufacturers (SMMs), digital transformation presents a significant challenge due to the general lack of resources to support technology adoption. These factors negatively impact SMMs in their competitiveness for digitalization as the future of manufacturing calls for, reducing their resilience to machine performance fluctuation and supply chain disruptions, and affecting the pipeline for workforce training, talent development and retention, which are critical to the sustainability of the community [2, 3]. The Covid-19 pandemic has further underscored the vulnerability of a technologically ill-equipped community in today's rapidly changing economy [4].

© The Author(s) 2023

H. Kohl et al. (Eds.): GCSM 2022, LNME, pp. 845–853, 2023.

[https://doi.org/10.1007/978-3-031-28839-5\\_94](https://doi.org/10.1007/978-3-031-28839-5_94)

As data is increasingly considered one of the most important resources that a manufacturer can possess [5], one major concern in digital transformation for many SMMs is the lack of sufficient, quality data to build AI models for rational, data-driven decision-making. With the advancement of communication technologies such as IoT, researchers have begun to explore the feasibility of *aggregating* data from multiple data owners to jointly build AI models that overcomes the data limitation problem that each individual SMM is facing [6]. Compared to the traditional approach that relies on data from a single SMM, such a collaborative, data-sourcing approach is expected to overcome data quality issues that typically arise in siloed data scenarios, such as data imbalance and low data quantity, by utilizing the complementary information from multiple SMMs [7, 8]. The results are reduced production interruption for data collection, improved resource utilization, and more accurate and robust AI models to support the sustained growth of the SMMs in the community.

A major hurdle towards data-oriented collaboration is the concerns about data-privacy, as traditionally, proprietary data collected from individual data owners will need to be shared in a central server for data aggregation-enhanced model building. To overcome such concerns, techniques for transfer learning [9] and data synthesis [10] have been developed. Transfer learning first builds a model in a source domain (e.g., a SMM with high-quality data), before fine-tuning it using data from a target domain (e.g., another SMM) for adaptation and refinement [11]. It has been successfully implemented in applications such as human action recognition in human-robot collaboration (HRC) [12, 13] and machine condition monitoring [14, 15]. In comparison, data synthesis aims to learn data distribution and synthesize new data samples to increase data quantity and reduce imbalance. Recent development of generative adversarial network (GAN) has improved data synthesis capability by using a pair competing networks, one for improving synthesis quality and the other for distinguishing real data from synthetic data [10]. The two ultimately reach an equilibrium point for high-fidelity data synthesis. The effectiveness of GAN has been demonstrated for machine condition monitoring [16–18].

Despite the progress, both methods have their limitations. For example, a data model can be SMM-specific and not suited for deployment to different SMMs without substantial modification that still does not guarantee successful model transfer [9]. As a result, when the number of SMMs becomes large, this method becomes computationally inefficient. In addition, training of GAN requires that the available data samples have the same distribution as the underlying data distribution, which is difficult to guarantee if the data quantity is small [18].

To address this problem, federated learning [19] is investigated in this paper. In federated learning, each SMM contributes to the construction of a global data model by computing a local update of relevant model parameters using its own data. The local updates from multiple SMMs are then aggregated by a central server for the training of the global model. Since only the updated parameters of the global model instead of the data themselves are shared during the model update process, data privacy is preserved. In addition, as information from all the participating SMMs is utilized during the model training process, the global model is SMM-independent. Furthermore, federated learning

does not impose restrictions on quantity, level of imbalance, or the distribution characteristic of the data being utilized, it is well-suited for real-world scenarios where none of these restrictions can be assumed. Recently, research on federated learning for machine condition monitoring has been reported [20–22]. However, these studies focused on a relatively small number of participating data owners ( $\leq 10$ ). In addition, since each of the data owners has full control of its data, it is possible that the data from a data owner may not participate during the iteration process of federated learning in realistic settings (e.g., due to scheduling conflict), leading to partial participation. Such partial participation has not been investigated in these prior efforts [20–22].

This paper aims to fill this research gap, and is organized as follows: Sect. 2 presents the theoretical background of federated learning. In Sect. 3, evaluation of the developed algorithm using publicly available experimental datasets is described. The results are discussed in Sect. 4, and conclusions are drawn in Sect. 5.

## 2 Theoretical Background

The key idea of federated learning is to solve an optimization problem [19]:

$$\min_{\mathbf{w}} \left\{ F(\mathbf{w}) = \sum_{k=1}^N p_k F_k(\mathbf{w}) \right\} \tag{1}$$

In Eq. (1),  $F(\mathbf{w})$  is the loss function of the *global* model with model parameters  $\mathbf{w}$  (e.g., network weights),  $N$  is the total number of participating data owners,  $p_k$  is the weights assigned to the  $k^{\text{th}}$  data owner such that  $p_k \geq 0$  and  $\sum_{k=1}^N p_k = 1$ . Without prior knowledge regarding the data from each data owner (as is usually the case with federated learning),  $p_k$  is empirically set to  $1/N$ .  $F_k(\cdot)$  is the local loss function.

Assume the number of training data from the  $k^{\text{th}}$  SMM is  $n_k: x_{k,1}, x_{k,2}, \dots, x_{k,n_k}$ , the local loss function  $F_k(\cdot)$  is defined as:

$$F_k(\mathbf{w}) = \frac{1}{n_k} \sum_{i=1}^{n_k} l(\mathbf{w}; x_{k,i}) \tag{2}$$

In Eq. (2),  $l(\mathbf{w}; x_{k,i})$  is the loss induced by the global model parameters  $\mathbf{w}$  and local data sample  $x_{k,i}$ . The specific formulation of  $l(\cdot)$  is application-dependent (e.g., mean squared error for prediction or cross-entropy for classification). In order to minimize Eq. (1), the gradient of each  $F_k(\mathbf{w})$  with respect to  $\mathbf{w}$  is first computed, which indicates the direction of minimizing  $F_k(\mathbf{w})$ . Then,  $\mathbf{w}$  is adjusted in this direction to obtain the new  $F_k(\mathbf{w})$ . These two steps constitute an *iteration* in federated learning.

Figure 1 details one such iteration: the  $j^{\text{th}}$  iteration. The central server first publishes the latest model parameters  $\mathbf{w}_j$  to all the data owners, which compute their own contributions to the global model update as:

$$\mathbf{w}_{j+1}^k = \mathbf{w}_j - \eta \nabla F_k(\mathbf{w}_j, \mathbf{x}_{k,1}, \mathbf{x}_{k,2}, \dots, \mathbf{x}_{k,n_k}) \tag{3}$$

where  $\eta$  is the learning rate and  $\nabla F_k$  is the gradient of  $F_k(\mathbf{w})$ . Then, the central server aggregates the contributions from each data owner,  $\mathbf{w}_{j+1}^1, \mathbf{w}_{j+1}^2, \dots, \mathbf{w}_{j+1}^N$  to obtain the new global model parameters  $\mathbf{w}_{j+1}$ .

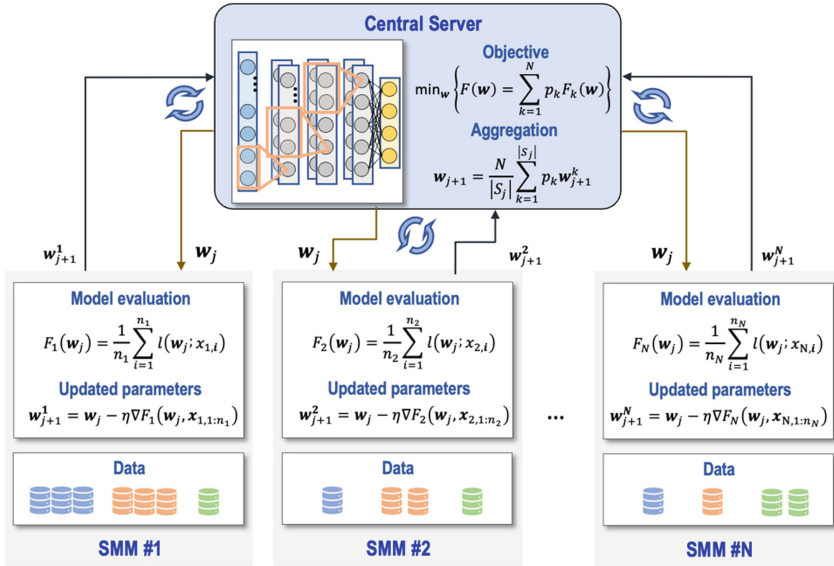


Fig. 1. Training iteration in federated learning

In federated learning, each data owner has full control of its own data. Realistically, only a subset  $S$  out of the total  $N$  owners may be available to participate at each iteration and  $S$  can vary from iteration to iteration. Therefore, the aggregation is expressed as:

$$\mathbf{w}_{j+1} = \frac{N}{|S_j|} \sum_{k=1}^{|S_j|} p_k \mathbf{w}_{j+1}^k \tag{4}$$

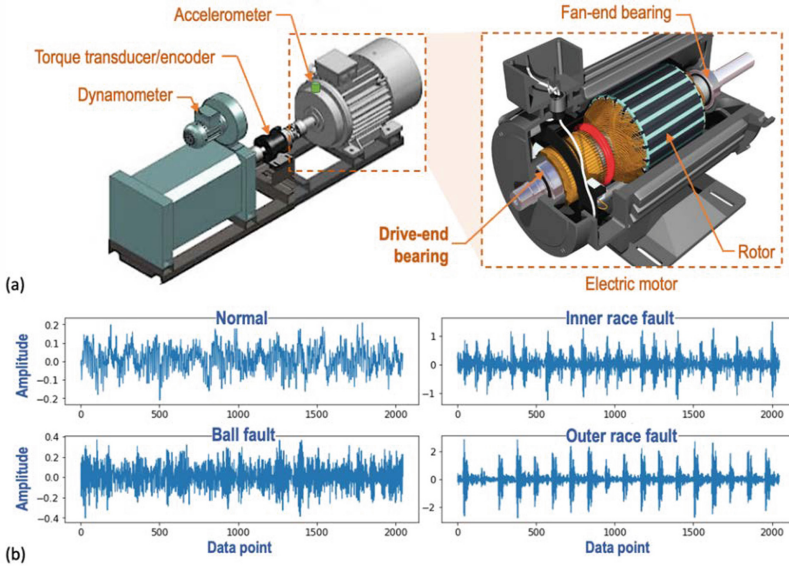
where  $|S_j|$  is the size of  $S_j$ . The expectation of the federated learning loss function in Eq. (1),  $F(\cdot)$ , has shown to be bounded [19], which provides the theoretical support for federated learning as a learning method that is convergent by nature.

### 3 Algorithm Evaluation

The effectiveness of the developed federated learning algorithm for machine condition monitoring is evaluated using bearing dataset at Case Western Reserve University (CWRU) [23]. In this dataset, single point faults were seeded to the drive-end bearing (Fig. 2) at the inner or outer race of the bearing, as in the rolling ball. Vibration signals were sampled at 12 kHz, with the bearing rotating speed being 1750 rpm. Signals corresponding to the three fault types were evaluated and compared with signals collected from a healthy, normal bearing, which serves as a reference base.

To evaluate the federated learning algorithm, the dataset is first split into non-overlapping sequences with each containing 800 vibration data points. In total, there are 7,500 sequences in the dataset. The sequences are then allocated into 50 sets to simulate 50 participating data owners (e.g., SMMs), with each set containing a different

number of data sequences to simulate varying data quantity from the different SMMs. The data in each set is not restricted to any specific distribution characteristic during the allocation, allowing its level of imbalance to vary from one data owner to another. Each set is then further split into a training set and a testing set with a split ratio of 70% to 30%.



**Fig. 2.** (a) CWRU bearing test platform [23–25]; (b) sample waveforms of 4 bearing conditions

During each iteration of the federated learning process, the number of participating data owners can vary depending on whether each of them grants the access to its data. To simulate such a scenario, a random number  $n$  between 41 and 50 is first generated in each iteration, then  $n$  data owners are randomly selected from total of 50 based on a uniform distribution, corresponding to a  $\geq 80\%$  participation rate at each iteration.

The global model of federated learning investigated in this study is based on a 1D convolutional neural network (1D-CNN). This network structure is selected due to its demonstrated capability [26] of extracting multi-level features from sequential data (such as bearing vibration signal) and associating the features to variables of interest (i.e., bearing fault types). The 1D-CNN network structure is determined using a parameter search and is shown in Fig. 3. The learning rate is set to 0.01, the optimizer is stochastic gradient descent (SGD), and batch size is set to 16. Federated learning is carried out using an Nvidia P100 GPU with 16 GB RAM on Google Colaboratory.



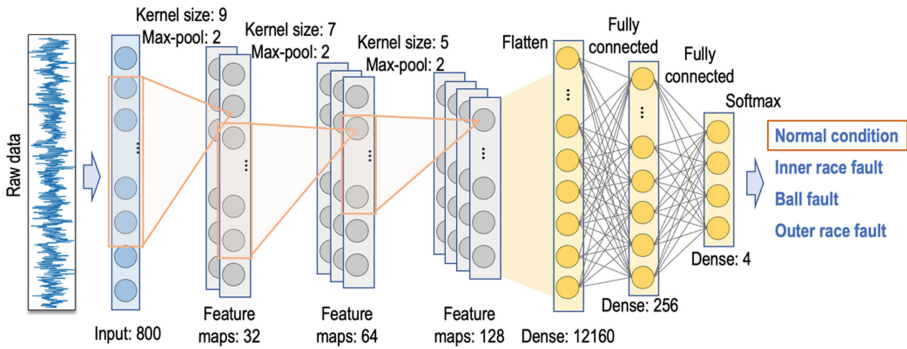


Fig. 3. 1D-CNN structure for federated learning

## 4 Results and Discussion

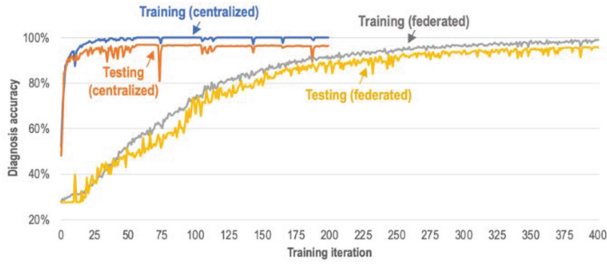
For evaluation of the global model obtained through federated learning, its performance is compared with that of another two scenarios:

**Centralized:** data from all the owners are merged into a single dataset to carry out 1D-CNN training and evaluation. It should be noted this scenario is not feasible in realistic settings and only serves the purpose of evaluating the diagnosis accuracy (in %) and convergence behavior (in number of iterations) of federated learning as compared to an ideal scenario.

**Siloed:** individual data model is established for each data owner using its own training and testing data. The purpose is to evaluate improvement in diagnosis accuracy (in %) and robustness (in accuracy standard deviation among SMMs) enabled by the global model of federated learning as compared to the model built using siloed data.

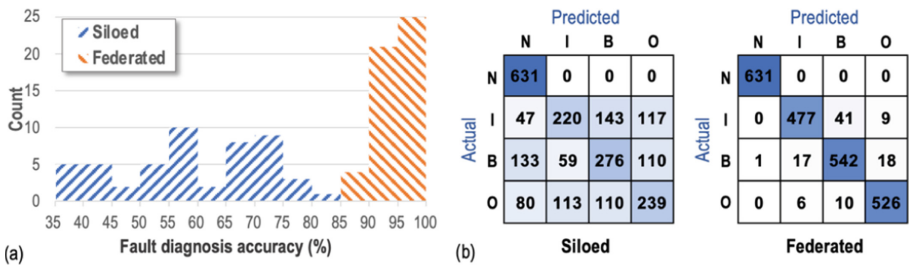
First, the training and testing curves associated with federated learning and *centralized* scenario are plotted in Fig. 4. Federated learning has shown to arrive at about the same level of accuracy as the centralized scenario (99% training accuracy and 96% testing accuracy), indicating that the global model obtained is as effective as the model created using centralized strategy. It is also noted that centralized strategy converges faster (~50 iterations vs. ~400 iterations for federated learning), indicating that weights update in federated learning is suboptimal. This can be attributed to the fact that both the local gradient computation and the non-participating data owners at each iteration can induce bias into weights update, which is then propagated over the entire iteration process and causes slow convergence. Since individual iteration in federated learning can take longer to complete as compared to the centralized scenario due to the additional communication delay with different data owners, the negative impact of slow convergence can be exacerbated. Future research will investigate methods to accelerate model convergence, which is currently an open research topic per the literature [19].

The performance of federated learning is then compared to the *siloed* learning scenario. Model accuracy evaluated on testing dataset from each SMM is plotted as histogram in Fig. 5(a) and associated confusion matrices are shown in Fig. 5(b). It is seen that model accuracy in diagnosis of bearing fault types under the siloed scenario ranges from 35% to 84% with a mean accuracy of only 60%. By contrast, using federated



**Fig. 4.** Training and testing curves: centralized vs. federated scenarios

learning, not only the mean accuracy has increased from 60% to 95%, which represents a 58% improvement, the performance variation is also reduced, as reflected by the standard deviation of the diagnosis accuracy (from 12% in siloed scenario to 3% in federated learning, a reduction of 75%). These results demonstrated the global model is both more accurate and more robust as compared to learning from siloed data.



**Fig. 5.** Siloed vs. federated: (a) histogram of fault diagnosis accuracy for SMMs; (b) confusion matrix of fault diagnosis. N: normal; I: inner race fault; B: ball fault; O: outer race fault

## 5 Conclusions

To enhance sustainability and resilience of manufacturers toward building smart and connected communities through cross-manufacturer collaboration, a federated learning approach has been investigated for improved resource and knowledge sharing while preserving data-privacy. The method is characterized by local model update and global parameter aggregation to arrive at a global model for all participating manufacturers. Using bearing condition monitoring as a representative application, the global model obtained through federated learning has shown a 58% improvement in fault diagnosis accuracy while reducing performance variation by 75% as compared to learning from siloed data, thereby demonstrating an effective solution to a common problem where insufficient or small data constrains the development of high-quality model at individual manufacturer’s site. By arriving at a global diagnosis accuracy comparable to the one that would have been achieved using centralized strategy (96%), federated learning has shown

to satisfactorily meet the performance expectation for cross-manufacturer collaboration. One limitation of the presented method is that it requires homogeneous sensor data type from each participating manufacturer as input to the model. Future research will relax this requirement to accommodate different types of sensor data to facilitate broader acceptance of the federated learning method in real-world settings. In addition, future research will also investigate model convergence for increased computational efficiency in data intensive applications.

**Acknowledgement.** The authors acknowledge support for this research by the National Science Foundation under award CNS-2125460.

## References

1. Monostori, L., et al.: Cyber-physical systems in manufacturing. *CIRP Ann.* **65**(2), 621–641 (2016)
2. Váncza, J., et al.: Cooperative and responsive manufacturing enterprises. *CIRP Ann.* **60**(2), 797–820 (2011)
3. Lanza, G., et al.: Global production networks: design and operation. *CIRP Ann.* **68**(2), 823–841 (2019)
4. Gupta, D., Bhatt, S., Gupta, M., Tosun, A.S.: Future smart connected communities to fight covid-19 outbreak. *Internet of Things* **13**, 100342 (2021)
5. Gao, R., Wang, L., Helu, M., Teti, R.: Big data analytics for smart factories of the future. *CIRP Ann.* **69**(2), 668–692 (2020)
6. Bechtsis, D., Tsolakakis, N., Iakovou, E., Vlachos, D.: Data-driven secure, resilient and sustainable supply chains: gaps, opportunities, and a new generalised data sharing and data monetisation framework. *Int. J. Prod. Res.* 1–21 (2021)
7. Zhang, J., Gao, R.: Deep learning-driven data curation and model interpretation for smart manufacturing. *Chinese J. Mech. Eng.* **34**(1), 1–21 (2021)
8. Sabbagh, R., Gawlik, B., Sreenivasan, S.V., Stothert, A., Majstorovic, V., Djurdjanovic, D.: Big data curation for analytics within the cyber-physical manufacturing metrology model (CPM3). *Procedia CIRP* **93**, 491–495 (2020)
9. Yan, R., Shen, F., Sun, C., Chen, X.: Knowledge transfer for rotary machine fault diagnosis. *IEEE Sens. J.* **20**(15), 8374–8393 (2019)
10. Kusiak, A.: Convolutional and generative adversarial neural networks in manufacturing. *Int. J. Prod. Res.* **58**(5), 1594–1604 (2020)
11. Li, S., Zheng, P.: transfer learning for smart manufacturing: a stepwise survey. *IFAC-PapersOnLine* **53**(5), 37–42 (2020)
12. Wang, P., Liu, H., Wang, L., Gao, R.: Deep learning-based human motion recognition for context-aware human-robot collaboration. *CIRP Ann.* **67**(1), 17–20 (2018)
13. Xiong, Q., Zhang, J., Wang, P., Liu, D., Gao, R.: Transferable two-stream CNN for human action recognition. *J. Manuf. Syst.* **56**, 605–614 (2020)
14. Wang, P., Gao, R.: Transfer learning for enhanced machine fault diagnosis in manufacturing. *CIRP Ann.* **69**(1), 413–416 (2020)
15. Guo, L., Lei, Y., Xing, S., Yan, T., Li, N.: Deep convolutional transfer learning network: a new method for intelligent fault diagnosis of machines with unlabeled data. *IEEE Trans. Industr. Electron.* **66**(9), 7316–7325 (2018)

16. Lee, Y.O., Jo, J., Hwang, J.: Application of deep neural network and generative adversarial network to industrial maintenance: a case study of induction motor fault detection. In: IEEE International Conference on Big Data (Big Data), pp. 3248–3253 (2017)
17. Shao, S., Wang, P., Yan, R.: Generative adversarial networks for data augmentation in machine fault diagnosis. *Comput. Ind.* **106**, 85–93 (2019)
18. Wang, Z., Wang, J., Wang, Y.: An intelligent diagnosis scheme based on generative adversarial learning deep neural networks and its application to planetary gearbox fault pattern recognition. *Neurocomputing* **310**, 213–222 (2018)
19. Li, X., Huang, K., Yang, W., Wang, S., Zhang, Z.: On the convergence of FedAvg on non-IID data. In: International Conference on Learning Representations (2019)
20. Geng, D., He, H., Lan, X., Liu, C.: Bearing fault diagnosis based on improved federated learning algorithm. *Computing* **104**(1), 1–19 (2021). <https://doi.org/10.1007/s00607-021-01019-4>
21. Zhang, W., Li, X., Ma, H., Luo, Z., Li, X.: Federated learning for machinery fault diagnosis with dynamic validation. *Knowl.-Based Syst.* **213**, 106679 (2021)
22. Chen, J., Li, J., Huang, R., Yue, K., Chen, Z., Li, W.: federated learning for bearing fault diagnosis with dynamic weighted averaging. In: International Conference on Sensing, Measurement & Data Analytics in the era of Artificial Intelligence, pp. 1–6 (2021)
23. Bearing Data Center, [engineering.case.edu/bearingdatacenter](http://engineering.case.edu/bearingdatacenter)
24. Industrial quick search. [www.iqsdirectory.com/articles/dynamometers.html](http://www.iqsdirectory.com/articles/dynamometers.html)
25. AC motor exploded view. <https://www.acmotorkitpicture.blogspot.com/ac-motor-exploded-view.html>
26. Eren, L., Ince, T., Kiranyaz, S.: A generic intelligent bearing fault diagnosis system using compact adaptive 1D CNN. *J. Signal Process. Syst.* **91**(2), 179–189 (2019)





**Open Access** This chapter is licensed under the terms of the Creative Commons Attribution 4.0 International License (<http://creativecommons.org/licenses/by/4.0/>), which permits use, sharing, adaptation, distribution and reproduction in any medium or format, as long as you give appropriate credit to the original author(s) and the source, provide a link to the Creative Commons license and indicate if changes were made.

The images or other third party material in this chapter are included in the chapter's Creative Commons license, unless indicated otherwise in a credit line to the material. If material is not included in the chapter's Creative Commons license and your intended use is not permitted by statutory regulation or exceeds the permitted use, you will need to obtain permission directly from the copyright holder.





# Immersive Virtual Work Integrated Learning: A Development of an Interactive Learning Environment for Rail Components Manufacturing

Nokulunga Zamahlubi Dlamini<sup>1</sup>(✉) , Khumbulani Mpofu<sup>1</sup> ,  
Boitumelo Ramatsetse<sup>2</sup> , and Olusambo Makinde<sup>3</sup> 

<sup>1</sup> Department of Industrial Engineering, Tshwane University of Technology, Pretoria 0001,  
South Africa

dlamininz@tut.ac.za

<sup>2</sup> Department of Mechanical and Mechatronic Engineering, Stellenbosch University,  
Stellenbosch 7600, South Africa

Ramatsetse@sun.ac.za

<sup>3</sup> Department of Quality and Operations Management, University of Johannesburg,  
Johannesburg 2028, South Africa

Olasumbom@uj.ac.za

**Abstract.** Undergraduate students pursuing their studies in the engineering discipline in higher education institutions (HEI) are expected to complete their work integrated learning (WIL) component as part of their curriculum. This is a compulsory module traditionally performed in the workplace environment over a specified time. However, with the scarcity of placement-based WIL, as well as the Covid-19 pandemic, there has been a reduction in the intake of students to accomplish their studies. This paper presents, a human centered design (HCD) model for developing an immersive virtual reality (IVR) rendered with an HTC Vive Pro head mounted display (HMDs) platform capable of training industrial engineering undergraduate students on the manufacturing procedure of rail components using a reconfigurable guillotine shear and bending press machine (RGS&BPM) as part of the set of immersive virtual work integrated learning (IVWIL) activities. The study explores current literature and the HCD approach to designing and developing the immersive interactive training platform. It highlights the important aspects of the development of the immersive virtual environment and recommends future work.

**Keywords:** Virtual reality · Work integrated learning · Human centered design · Immersive virtual work integrated learning · Higher education institutions

## 1 Introduction

The digital era has a robust desire for the modern industry to rationalize education and training programs to produce knowledgeable engineering graduates. Crucial to attaining

this, is the ability to integrate academic learning with practice in real work environment. WIL is the term used by the world associations for cooperative education to lessen the several confusions of terms used in the higher institutions, describing the educational approach for undergraduates' students to apply their theoretical knowledge into real work professional practice relevant to their field of study or future career [1–4]. VR technology launches a critical function in computer-generated 3D models simulating real physical environments and physical situations by offering the immersed user to interact, hear and touch the 3D virtual environment (VE) [5]. VR technology has potential to positively impact students work readiness through offering immersive training experiences, transfer of skills, educational learning outcomes, and achievements in the different scenarios of their future profession. Till to date, undergraduates are not progressing academically due to the scarcity of placement-based WIL opportunities in South African industries. This is a dilemma because placements opportunities are not always readily available in South Africa and there is pressure within institutions and from certain faculty members to eliminate the WIL component from curricula [6].

## **2 State of the Art Review**

Research focusing on instructional design methods, education learning outcomes, intervention characteristics, and evaluation measures associated with immersive VR usage has been sparse [7]. Hence, the urge to follow a human centered design approach which is iterative, measurable and results driven in designing the virtual environment that will be able to train, expose and prepare undergraduate student to be work ready and employable humans who can effectively perform work tasks and interact in any industry setting.

### **2.1 Work Integrated Learning**

The opportunity to be placed in a real company or industry setting, creates a refreshing and life changing experience to undergraduates. Several studies have demonstrated that WIL programs offer vital benefits for undergraduates, skilled employers, and the higher learning institutions [8]. Coll et al. [1] stated that the crucial purpose of work-integrated learning is to provide undergraduate students with a comprehensive ability and skills set desired by potential employers. Furthermore, Govender and Wait [9], mention that WIL must assist undergraduate students understand the information learned in the university lecture hall, advance their knowledge, and assist them to complete a real-world task successfully and be competent.

### **2.2 Virtual Reality**

Currently, VR systems can be categorized into three classifications based on immersion level, and the type of interfaces used in the system. These are the fully immersive, semi-immersive and non-immersive VR systems [10]. Fully immersive VR technology user wears HMDs, this device consists of small screens in front of both eyes, display the 3D images and magnifies them to fill a wide field of view [11]. It, furthermore, enable user to be totally immersed, isolated from the real world, and generates the feeling of

truly being inside an environment and interacting with it, rather than observing a screen. Hardware used in Semi-immersive VR technology are high resolutions screens or walls through stereo projection systems, special stereo eyewear and 3D controllers or joysticks to handle input data and it is also called cave automatic VE [12,13]. In semi-immersive VR user is partially immersed in VE and this could increase the feeling of immersion or presence. Non-immersive/ desktop VR, users observe the virtual world on desktop and there is no immersive feeling only high-resolution monitor and mouse are hardware used, but with the lower cost incurred with the hardware, it makes it easy to use and easily accessible.

### **2.3 Virtual Work Integrated Learning (VWIL)**

Wood et al. [14] mention that virtual WIL can be defined as an immersive WIL experience in a context created to imitate the functions and operations of a workplace with input by the industry, educational institution, and the student. The introduction of VR courses and development of authentic and relevant VE by HEI are increasing, hence instructional designers and developers who want to incorporate VR in WIL curricular need to develop customized teaching and learning platforms for undergraduates' students that are authentic, interactive, and possess impactful learning. Radianti et al. [15] examined IVR in higher education exclusively and found that 70% of the 38 studies in the review did not include learning theory for forming the foundation of the VR activity. Male [16] developed and steered eight modules to support non-placement WIL, the author identified the requirements and learning outcomes to design a suite of VWIL for engineering students to engage with professional engineering practice. Immersive virtual work integrated learning can enhance students' curiosities, excitements, and the value of experience in learning technical skills. Furthermore, undergraduate student who had an IVWIL experience mentioned that positive learning, transferability of skills learned, assisted them in acquiring graduate employment and were better prepared for engineering practice [17].

## **3 Methodology**

The rail transportation industry in South Africa, commutes more than 2.3 million people per day making it an important mode of transportation [18]. Thus, the reason for recent investment in rail manufacturing and the need to train undergraduate students on the set of work integrated learning activities, machinery and equipment used at the rail industry. This section introduces the case study of the reconfigurable guillotine shear and bending press machine to be used to train the undergraduate students on how to form the rail components using the machine and the iterative processes of the HCD.

### **3.1 Reconfigurable Guillotine Shear and Bending Press Machine (RGS&BPM)**

The transition from traditional machine systems to current reconfigurable machine (RM) requires consistency in achieving the requirements brought by the changes on the customer demand, product life cycle and growing variation of tailored quality products.

As mentioned by Koren et al. [19] a RM is a machine whose structures can be altered to provide alternative functionality to meet production turnaround time. According to Sibanda et al. [20] RGS&BPM was designed at the onset to cut variable lengths of sheet metal pieces into the required sizes and then switch functionality to perform bending of varying length sizes of sheet metal pieces into multitudes of shapes required by the clients.

### 3.2 Human-Centered Design Process

The human centered design (HCD) process is followed to design and develop the virtual environment suitable to train, expose and discover the benefits of an IVWIL experience to final year industrial engineering undergraduates' students on the manufacturing processes of rail components using the RGS&BPM and performing time and motion studies on the virtual manufacturing process. HCD as described by [21] is a system design and development that resolves to create interactive usable systems by focusing on the use of the system, applying human factors or ergonomics, usability knowledge and techniques. Five key HCD iterative processes as described by [21] are shown in Fig. 1 which must be understood and undertaken to successfully incorporate the design and development of the IVWIL training platform. Martin & Hughes [22] states that WIL is a three-way relationship between the student, the academic institution, and the workplace, it requires all involved to perform specific tasks and accept certain responsibilities.

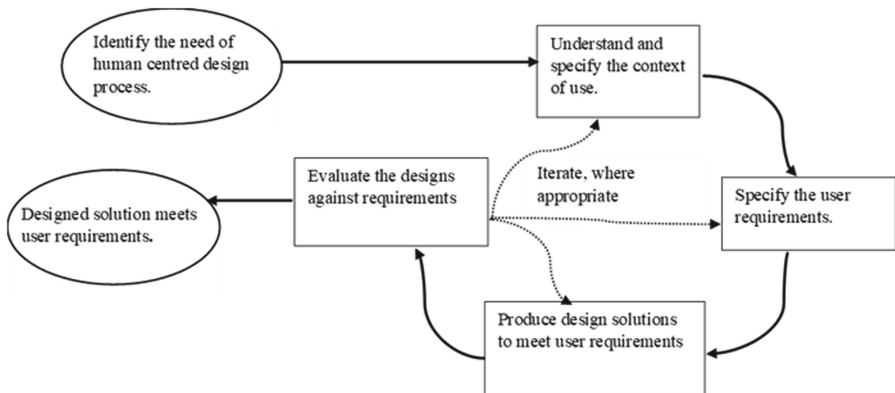


Fig. 1. ISO 9241- 210 (2010)

### 3.3 Understand and Specify the Context of Use

A pilot study to be conducted with industrial engineering undergraduates' students identify the following priority areas of training in a rail manufacturing plant without prior industry experience:



- Rail component manufacturing: Undergraduate student need to understand how an RGS&BPM can be used to manufacture a plain sheet metal to the required rail component. The components to be manufactured are the train door panel, co assy lower bracket, and assy support bracket component.

The development of a sufficiently detailed IVWIL training model must be manageable, easily understood and clearly defines the learning outcome. SimLab soft a software compatible to create real-time VE and immersive experiences is used for the development of the VWIL training platform. The 3D models in the training platform were created using SolidWorks then migrated to the Simlab software for the development.

### 3.4 Specify the User Requirement

The IVWIL training platform is custom designed to be used by a group of final year industrial engineering undergraduate students. The researcher will train and monitor the users and the WIL department lecturer will supervise the project. A user story card based on agile systems development method was used as a requirement tool to model and document all the requirements needed by the user to perform the task. Bik et al. [23] defines user story as an essential element tool to explain the type of user, what function they must perform and what object they need, this tool is an easy explanation of a user requirement needed to perform the operation in the system.

### 3.5 Produce Design Prototype and Design Solutions

Figure 2 demonstrates the procedure of how the virtual environment is developed from creating the 3D models needed for the system and importing them to the SimLab software for the simulation process.

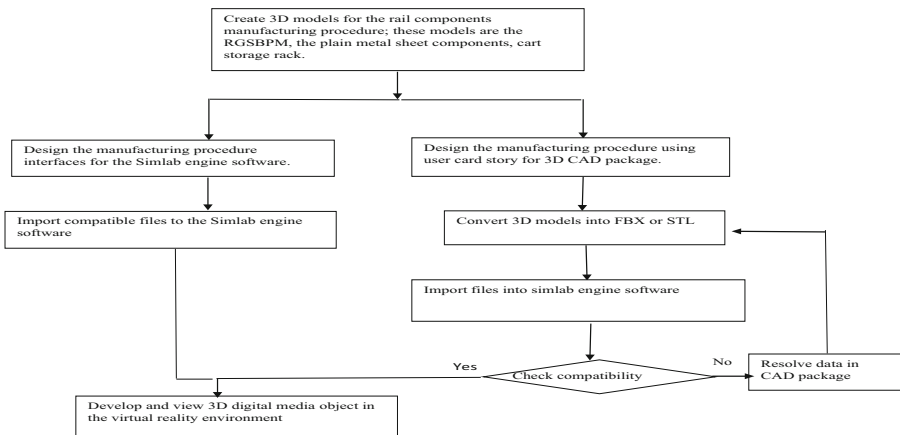


Fig. 2. Procedure for preparing the CAD models for the immersive 3D virtual environment

Churchville [24] describes user interface (UI) as a channel between human and computer interaction as the point where a user will interact with a computer or machine

to complete tasks, the purpose of a UI is to allow a user to effectively control a computer or machine they are interacting with, and for feedback to be received to communicate effective completion of tasks. The design model user interfaces and instructions were created for the IVWIL training platform. These interfaces direct users on how to navigate and perform tasks in the system.

## 4 Findings and Discussion

This was an inhouse project-based learning that took a period of twelve months by a novice instructional designer who is the researcher of this study and a novice software developer who capacitated themselves using asynchronous e-learning through intensive review of literature, using search engines, and forums to design and develop the environment. An ongoing pilot study on the evaluations of the undergraduate students based on the requirements of the training system and learning outcomes are taking place. Overall, findings from the design and the development of the IVWIL training platform necessitates careful planning and involving all product's stakeholders; undergraduate student, engineers, manufacturers, higher institution can help instructional design engineers design virtual environments that's sustainable and socially beneficial to be used for training by local communities, industries, and schools. VR enable sustainability in education by providing various training experiences that are impossible, scarce to access and difficult to experience in real life industry setting where safety measures are concerned in some school modules. Furthermore, VR as an educational tool can further contribute to the sustenance of the environment, economic and social dimension in all aspects of its use such as in the process of design, commissioning, and training. Though it was a successful project integrating outsourced experts in the design and development would have greatly enhanced the speed of completing the project and having support structure to guide the novice developers when enquires arise. Other researchers have conducted experiential learner centred design and virtual fieldtrips to train their undergraduate students. Virtual reality an inventive educational tool for engineering studies, makes it possible for undergraduates' students to apply the relevant knowledge and understanding gained from their course of study. This immersive virtual environment experiences can equip and prepare undergraduate students for a realistic and practical solution of a real-life industry tasks.

## 5 Conclusion

This paper described the design and development of IVWIL training platform using the HCD approach. The key parameters of HCD approach on the development of the IVWIL training platform were discussed and the design of the system was presented. A user story card was used as a user requirement tool explaining the tasks to be done by the undergraduate student to manufacture the rail components using the RGS&BPM. As an immerging and interactive technological approach, IVWIL can be considered to promote active learning, cost-effective, and accessible training opportunities for undergraduates. Government, industries, institutions, and the community all play a role in

raising awareness and promoting the benefits of this approach in addressing the ever-increasing scarcity of placement-based WIL. This work advances the field of IVWIL access by providing a novel approach that helps in identifying, designing, and developing a training platform that can benefit institutions, undergraduates, and industries. It is recommended to do further experiments to design full course modules for students to interact with and VR assessment techniques to evaluate user. The last phase of the HCD is to evaluate the user experience in the system to determine its significance and effectiveness. Henceforth, future work entails a pilot study to evaluate the designs over the requirements to prove the capability and effectiveness of the training system to the undergraduate students in engineering education using the IVWIL programs.

**Acknowledgement.** The researchers acknowledge the support and assistance of the Industrial Engineering department of Tshwane University of Technology, Gibela Rail Consortium, and the National Research Foundation (133695) of South Africa for their financial and material assistance towards executing this research project. The opinions presented in this paper are those of the authors and not the funders.

## References

1. Coll, R.K., et al.: An exploration of the pedagogies employed to integrate knowledge in work-integrated learning. *J. Cooper. Educ. Internships* **43**, 14–35 (2011)
2. Franks, P., Blomqvist, O., Coll, R., Eames, C.: The World Association for Cooperative Education: The global network that fosters work-integrated learning. In: *International Handbook for Cooperative Education: An International Perspective of the Theory, Research and Practice of Work-Integrated Learning*, pp. 283–289 (2004)
3. Cooper, L., Orrell, J., Bowden, M.: *Work Integrated Learning: A Guide to Effective Practice*. Routledge 5 April 2010
4. Smith, C.: Evaluating the quality of work-integrated learning curricula: a comprehensive framework. *High. Educ. Res. Dev.* **31**, 247–262 (2012)
5. Goold, A., Augar, N.: Using virtual meeting spaces for work integrated learning. *Proc. Ascilite Auckland* 367–371. *Journal* **2**(5), 99–110 (2016)
6. Lewis, M., Holtzhausen, N., Taylor, S.: The dilemma of work-integrated learning (WIL) in South African higher education-the case of Town and Regional Planning at the University of Johannesburg. *Town and Regional Plan.* **570**, 25–35 (2010)
7. Hamilton, D., McKechnie, J., Edgerton, E., Wilson, C.: Immersive virtual reality as a pedagogical tool in education: a systematic literature review of quantitative learning outcomes and experimental design. *J. Comput. Educ.* **8**(1), 1–32 (2020). <https://doi.org/10.1007/s40692-020-00169-2>
8. Doolan, M., Piggott, B., Chapman, S., Rycroft, P.: The benefits and challenges of embedding work integrated learning: a case study in a university education degree program. *Aust. J. Teach. Educ.* **44**, 91–108 (2019)
9. Govender, C.M., Wait, M.: Work integrated learning benefits for student career prospects–mixed mode analysis. *South Afr. J. Higher Educ.* **31**(5), 49–64 (2017)
10. Bamodu, O., Ye, X.M.: Virtual reality and virtual reality system components. In: *Advanced Materials Research*, vol. 765, pp. 1169–1172. Trans Tech Publications Ltd. (2013)

11. Van Wyk, E.A.: An evaluation framework for virtual reality safety training systems in the South African mining industry. Doctoral dissertation, University of South Africa (2015)
12. Van Wyk, E.A., de Villiers, M.R.: An evaluation framework for virtual reality safety training systems in the South African mining industry. *J. South Afr. Inst. Min. Metall.* **119**(5), 427–436 (2019)
13. DeFanti, T., et al.: The future of the CAVE. *Open Eng.* **1**(1), 16–37 (2011)
14. Wood, Y.I., Zegwaard, K.E., Fox-Turnbull, W.: Conventional, remote, virtual and simulated work-integrated learning: a meta-analysis of existing practice. *Int. J. Work-Integrated Learn.* **21**(4), 331–354 (2020)
15. Radianti, J., Majchrzak, T.A., Fromm, J., Wohlgenannt, I.: A systematic review of immersive virtual reality applications for higher education: design elements, lessons learned, and research agenda. *Comput. Educ.* **2020**(147), 103778 (2020)
16. Male, S.: Implementing virtual work integrated learning. In: 29th Australasian Association for Engineering Education Conference 2018 (AAEE 2018), p. 466. Engineers Australia (2018)
17. Australia, E.: Virtual work integrated learning for engineering students, Doctoral dissertation, Murdoch University (2019)
18. Nelson, S.X., et al.: Development of a 3D interactive training platform for assembly of bogie unit in the railcar learning factory. *Procedia Manuf.* **45**, 386–391 (2020)
19. Koren, Y., et al.: Reconfigurable manufacturing systems. *CIRP Ann.* **48**(2), 527–540 (1999)
20. Sibanda, V., Mpofo, K., Trimble, J., Kanganga, M.: Development of part families for a reconfigurable machine. *J. Eng. Design Technol. A head-of-print* (2019)
21. Iso, D.I.S.: 9241–210: 2010: Ergonomics of Human-System Interaction—Part 210: Human-centred Design for Interactive Systems (Formerly Known as 13407). International Standards Organization, Switzerland (2010)
22. Martin, A., Hughes, H.: How to make the most of work integrated learning, In: Citeseer (2011)
23. Bik, N., Lucassen, G., Brinkkemper, S.: A reference method for user story requirements in agile systems development. In: 2017 IEEE 25th International Requirements Engineering Conference Workshops (REW), pp. 292–298. IEEE (2017 September).
24. Churchville, F.2021. User Interface (UI). <https://searcharchitecture.techtarget.com/definition/user-interface-UI>. Accessed 25 Apr 2022

**Open Access** This chapter is licensed under the terms of the Creative Commons Attribution 4.0 International License (<http://creativecommons.org/licenses/by/4.0/>), which permits use, sharing, adaptation, distribution and reproduction in any medium or format, as long as you give appropriate credit to the original author(s) and the source, provide a link to the Creative Commons license and indicate if changes were made.

The images or other third party material in this chapter are included in the chapter's Creative Commons license, unless indicated otherwise in a credit line to the material. If material is not included in the chapter's Creative Commons license and your intended use is not permitted by statutory regulation or exceeds the permitted use, you will need to obtain permission directly from the copyright holder.





# A Proposed System for Greening Higher Education Institutions in Palestine

Ahmed Abu Hanieh<sup>(✉)</sup>  and Afif Akel Hasan 

Birzeit University, P.O.Box 14, Birzeit, Palestine  
ahanieh@birzeit.edu

**Abstract.** This article tackles the problem of greening university campuses of higher education institutions in Palestine. The paper concentrates on finding the adequate greening categories and key performance indicators to be used to assess the sustainability and green of higher education Institutions HEI. Each indicator has been weighted based on the opinion survey filled by academic experts from the different Palestinian universities. The weights of these indicators have been normalized to come up with a category score and a then a total score of the greening of the HEI. Eventually, a Go-Green integrated model is developed to form an initiative for any higher education institution wishes to enter into this sustainability race. Many steps and activities are suggested to turn any university to a green one. Through implying the Elasticity and Plasticity approach, it is possible to relate the level of green actions to social behavior. The impact of these sustainability aspects is reflected on higher education by implementation on university campus greening.

**Keywords:** Sustainability · Green campus · Elasticity-Plasticity · Go-Green model · Social behavior · Key performance indicators

## 1 Introduction

Higher education institutions objectives include education, research, and community service. HEI contribute to the development of the society leaders and show a good example of positive and responsible practices in the community. HEIs have important influence through education to shape the mindsets and values of people in relation to sustainability (Horan and O'Regan 2021). According to Žalėnienė and Pereira (2021), HEI are driving force for implementing sustainability, as well as are considered as a change agent and a catalyst to achieve sustainability. HEI provides required knowledge, skills and values to empower students to contribute to sustainable development (<https://www.eauc.org.uk/theplatform/aishe> Dec 2021). The university has a role to create the knowledge, integrating sustainable education and research programs, and promoting environmental issues to the public (Lourrinx and Budihardjo 2019). A sustainable university would show the following principles (Wright 2002; Lourrinx and Budihardjo 2019): Integrate social, ethical and environmental aspects, commitment to graduate attribute of critical systems thinking, encourage research, outreach and campus planning and create policies and practices to achieve equality and diversity.

© The Author(s) 2023

H. Kohl et al. (Eds.): GCSM 2022, LNME, pp. 862–871, 2023.

[https://doi.org/10.1007/978-3-031-28839-5\\_96](https://doi.org/10.1007/978-3-031-28839-5_96)

The Higher Education Sustainability Initiative (HESI) for Rio + 20 was established in 2012 by a group of UN partners as a platform to collaboratively champion education, research and actions for sustainable development in the Higher Education Institutions. Summary of Progress was reported by HESI in UNESCO World Conference on Education for Sustainable Development, Aichi-Nagoya 2014. Concerning education, it reported that most universities trying to integrate sustainability in their curricula, at least by introducing one standalone course. In research some universities highlighted sustainability research and publications by their students and faculty. In operation most of universities-initiated activities to green the campus including recycling initiatives, planting trees, encouraging bike services. In outreach a large number stated awareness programs to the public and hosted conferences and workshops on sustainability (Rio + 20 Higher Education Sustainability Initiative 2014).

UI GreenMetric is a university ranking system that was developed by University of Indonesia in 2010 for assessment and comparison of campus sustainability efforts. GM tool included six categories and forty indicators, Greening Universities Toolkit (Toolkit) is a United Nations Environment Program UNEP focusing on “transforming universities into green and sustainable campuses”. The toolkit includes four elements and 12 indicators (UNEP Toolkit 2013). Fisher et al. (2015) remarked that new tools are evolved in different regions of the world, and then they reviewed and compared different assessment sustainability tools and pointed out to the need for systematization of tools to allow for comparison. Objective of the assessment tool according to STAR tool (AASHE 2019) is to establish a framework for sustainability in all HEI. Enable comparisons over time and between universities. Give incentives for continuous improvement of sustainability. Simplify information sharing between HEI sustainability implementation. Develop a powerful, and wide university sustainability community. Lourrinx and Budihardjo (2019) in his paper determined how the UI GreenMetric is implemented at Diponegoro University in addition they gave recommendations for indicator that has not been fulfilled. Dziminska et al. (2020) propose a conceptual model that shows how universities could work as culture change agents for sustainable development. The paper gives the interrelations between university main operations of education, research and societal engagement in the context of sustainability. Horan and O’Regan (2021) assessed the utilization of sustainability indicator for HEI, and then they critical assessed 12 sustainability assessment tools SATs to develop a set of indicators, weighing method, and scoring to get the score for each criteria. Then they implemented this SAT in the Ireland’s higher education sector. Omazic et al. (2021) in their review on sustainability of HEI found out that the path of the HEI toward sustainability is not clear and they identified key concepts and research themes for sustainability and SD in HEI along with the research gaps. More research as case studies, projects, and methods sustainability and SD in HEIs is still needed. A holistic approach is needed that involving all areas of action and all stakeholders. According to many researchers (Findler et al 2019; Horan and O’Regan 2021; Lourrinx and Budihardjo 2019; Yawei et al. 2021) greening of education would include education curriculum, governance structures, campus operations, research focus, and outreach activities. Hence greening will cover all aspects of the HEI activities and areas. Indicators and tools to assess each of above areas have been developed. Various evaluation and ranking systems for the HEI sustainability have been developed and reviewed by researchers.

## 2 Proposed Greening System for Higher Education in Palestine

Based on review of the tools used worldwide and taken into consideration knowledge of local geographical, political, land, local resources, as well as social, economic, and educational system Table 1 shows the suggested categories and proposed indicators for greening of higher education institutions in Palestine. Meanwhile, the table gives the weights of categories and indicators as evaluated by local experts' team. The percentage of each category from the total score of the weights is shown in Fig. 1 while the percentage of each indicator from the total scores is shown in Fig. 2.

**Table 1.** Weights of categories and indicators in the proposed Greening of HEI

Categories	Cat. weight	Indicators (KPIs)	KPI weight	Measurement
Setting and Infrastructure (SI)	69.6	The ratio of open space towards total area	6.6	Area in m2 & Annual expenses of sustainability
		Area on campus covered in planted vegetation and trees	7.9	
		Area on campus for water absorbance	6.2	
		The ratio of open space area divided by campus population	6.5	
		Budget for sustainability effort	7.6	
Energy and climate change (EC)	76	Energy efficient appliances usage	8.5	Annual Electricity bill
		Smart building program implemented	7.7	
		The total electricity usage divided by total campus population	7.3	
		The ratio of renewable energy production towards total energy usage per year	8.5	
		Element of green building implemented	7.7	
		Greenhouse gas emission reduction	5.9	
Waste (WS)	76	Waste sorting & Recycling program	8.1	Budget of paper and consumables
		Program to reduce the use of paper and plastic in campus	9	
		Organic waste handling & treatment	7.2	
		Inorganic waste handling & treatment	7.1	
		Toxic waste handling & treatment	6.9	

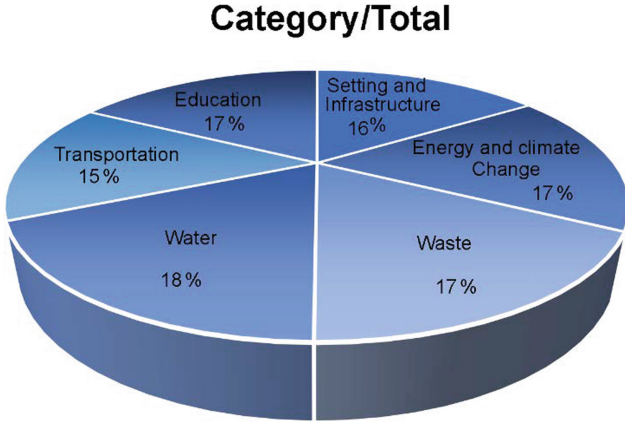
(continued)

**Table 1.** (continued)

Categories	Cat. weight	Indicators (KPIs)	KPI weight	Measurement
Water (WR)	80	Sewerage treatment & disposal	7.3	Annual Water bill
		Water conservation program	8.2	
		Water recycling program	8.1	
		The use of water efficient appliances	8	
Transportation (TR)	65	water consumed per person annually	7.7	Number of electric vehicles in campus & Annual fuel bills
		The ratio of total vehicles (cars and motorcycles) divided by total campus population	6	
		Shuttle services	6.2	
		Electric vehicles or Zero Emission Vehicles (ZEV) policy on campus	6.5	
		Bikes lanes and parking area	6.3	
		Ratio of parking to total campus area	6.5	
		Transportation program designed to limit or decrease the parking area on campus for the last 3 years	6.6	
		Number of transportation initiatives to decrease private vehicles on campus	6.7	
		Pedestrian policy on campus	7.1	
Education (ED)	75.5	The ratio of sustainability courses towards total courses/modules	8.2	Number of green courses & Number of green publications
		The ratio of sustainability research funding towards total research funding	8.2	
		Sustainability publications	7.7	
		Sustainability events	7.7	
		Sustainability student organizations	7.4	
		Sustainability websites	6.9	
		Sustainability reports	6.8	
<b>Total</b>	<b>442</b>		<b>262.9</b>	



Academic experts valued all six categories almost equally important with 15–18%. The study included ten experts; six of which are engineering university professors, two are business administration professors and two are technical engineers working in HE. They are asked to give each indicator a grade out of ten according to their experience.



**Fig. 1.** The percentage for each category of the total scores and category priority from 100

Figure 2 clearly demonstrates that water indicators have the highest weights among all indicators stressing importance of water resources and its sacristy in Palestine. Indicators relevant to emissions such as GHG emissions, and transportation indicators are viewed as lower priority.

The total grades given by all experts for each indicator have been summed and the indicator’s weight has been estimated as a percentage of the whole sum. The percentage of each category is estimated from the sum of its corresponding indicators and the weight of the category is taken as a percentage of all categories.

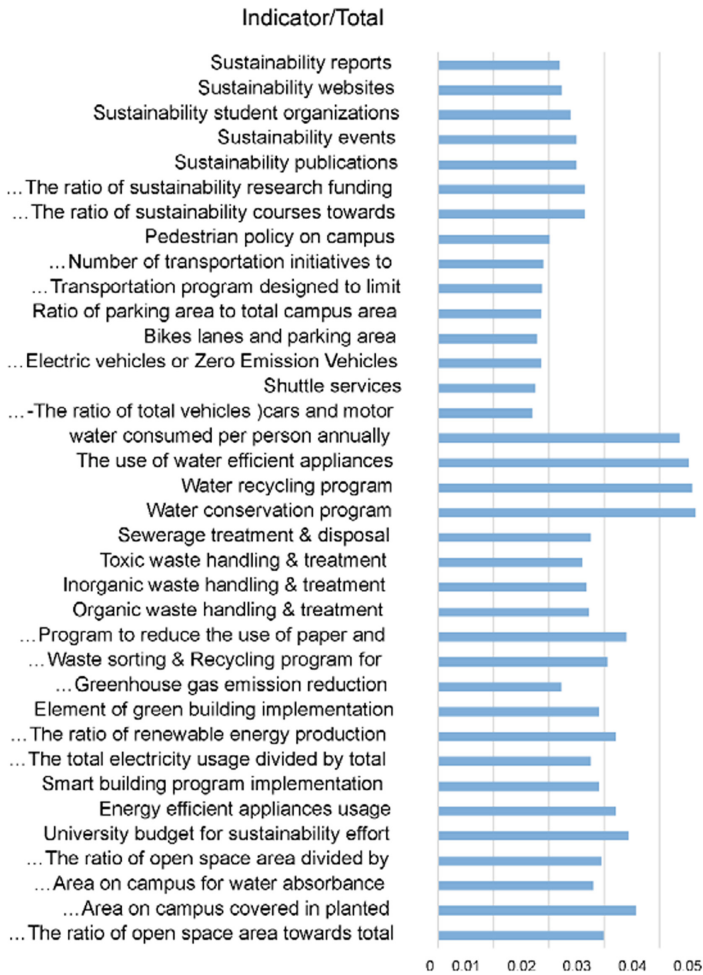


Fig. 2. The fraction for each normalized indicator of the total score

### 3 Elasticity and Plasticity of Sustainability Behaviour

Just like the behaviour of metals in solid mechanics, humans’ behaviour towards sustainability can either be elastic or plastic. Elasticity and plasticity of sustainability behaviour in higher education institutions as a function of institutional ecological changes is shown in Fig. 3. University community response to sustainability ecological changes is governed by the linear curve in the elasticity region, institutional changes lead to creating new sustainability behaviour. The slope (rate of change) of the line in the elastic region measures the rapidity of green response of the community to institutional changes, this slope reads:

$$Rate\ of\ change = slope = \frac{Sustainability\ behaviour\ (SB)}{Institutional\ changes\ (IC)}$$

The inclination of the curve indicates the speed of university community response to ecological changes; high slope means that the university will reach the required sustainable level sooner than low slope curve universities. In the elasticity region, there is always risk that the community returns back to zero point because the situation didn't reach to settling level. When the university reaches to the required level of implementing green requirements this is called the settling level and this remains constant no matter what institutional changes occur; this situation is called plasticity region because the sustainable behaviour remains stable. Before reaching plastic region the society passes through transition region where the sustainability social behaviour fluctuates till settling and this is normal because of the dynamic influences of each university community.

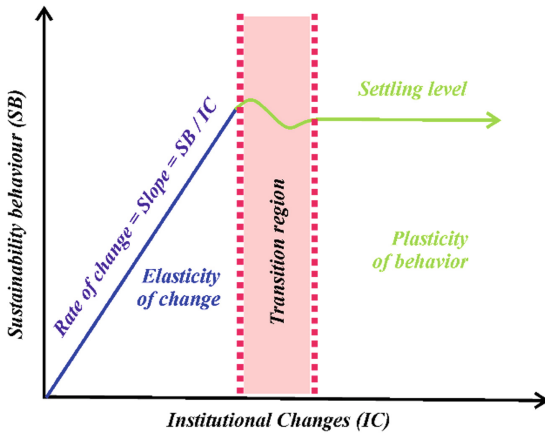
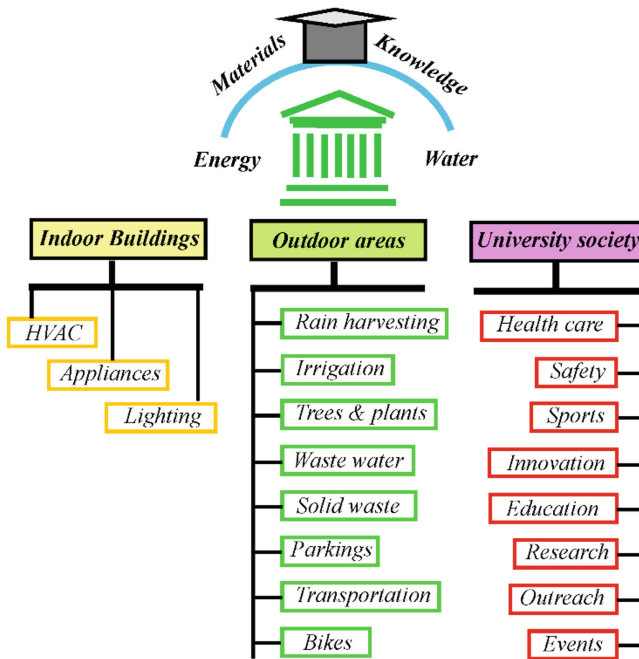


Fig. 3. Elasticity of change and plasticity of behaviour in higher education institutions

#### 4 Sustainable Go-Green Model of Higher Education

The resources of any higher education institutions are mainly classified to two main clusters; knowledge and materials. Knowledge includes educational resources of books and electronic scientific sources besides to instructors and students who hold this knowledge and transfer it. The second cluster includes all materials used to assist the teaching and learning process involving labs, equipment, devices, buildings and infrastructure. These two clusters are supported by water and energy which is considered the two main ecological sources needed for any society or institution. These clusters and supporters are the inputs to the sustainability model of higher education institution shown in Fig. 4. Institutional elements in higher education institutions are divided to three categories; indoor buildings, outdoor areas, and university society. These elements are the variables that can be changed in the abscissa of Fig. 3 against which sustainability behavior is measured. An elasticity-plasticity curve can be drawn for each one of these variables. Inside buildings sustainability can be increased by turning the Heating, Ventilation and Air-conditioning systems (HVAC) and other electric appliances to green ones by increasing

their electric efficiency and using renewable energy sources to function them. Lighting inside and outside buildings can be turned to green by using energy conserving LED lights and by using solar Photovoltaic (PV) panels to supply them with electricity. The outdoor areas in the higher education institution can be guided to be green harvesting rain water in special wells, this collected water can be used for the irrigation of trees and plants that in turn should be increased and encouraged in the campus area. Waste water should be treated and also used for irrigation or for flush in bathrooms. Irrigation either from harvested rain water or from treated waste water can be powered by renewable solar PV panels.



**Fig. 4.** Sustainable model of higher education

## 5 Conclusions

The foregoing research aims at discussing the principle and methodology to turn higher education institutions in Palestine to sustainable and green ones. The first step was done by selecting specific key performance indicators based on reviewed literature. The indicators were prioritized by higher education experts then based on these priorities the weights, and the percentage of these weights have been calculated relative to the categories and relative to the total sum. This kind of calculation helped in taking the decision about the most important indicator to be concentrated on during the way to go green. The implementation of each indicator can be tested using elasticity and plasticity

theorem where there is a specific level to be reached before settling situation. A sustainable model is presented in this paper showing all required indicator-related activities to be done in order to obtain a green model for a specific university. All indicators and activities should be related to the three sustainability pillars; social, environmental and economic to make sure that the institution goes well with the international sustainability development goals.

## References

- Horan, W., O'Regan, B.: Developing a practical framework of sustainability indicators relevant to all higher education institutions to enable meaningful international rankings. *Sustainability* **13**, 629 (2021). <https://doi.org/10.3390/su13020629>
- Žalėnienė, I., Pereira, P. Higher education for sustainability: a global perspective. *Geogr. Sustain.* **2**(2) (2021). <https://doi.org/10.1016/j.geosus.2021.05.001>
- Wright, T.: Definitions and frameworks for environmental sustainability in higher education. *Int. J. Sustain. High. Educ.* **3**(3), 203–220 (2002)
- Lukman, R., Glavič, P.: What are the key elements of a sustainable university? *Clean Technol. Environ. Policy* **9**, 103–114 (2007)
- Du, Y., Arkesteijn, M., Heijer, A., Song, K. Sustainable assessment tools for higher education institutions: guidelines for developing a tool for China. *Sustainability* **12**, 6501 (2020). <https://doi.org/10.3390/su12166501>
- Lourrinx, E., Budihardjo, M.: Implementation of UI GreenMetric at Diponegoro University in order to environmental sustainability efforts. In: *E3S Web of Conferences*, vol. 1, pp. 25–29. 9125 ICENIS 2019 200 (2007). <https://doi.org/10.1051/e3sconf/2010>
- Findler, F., Schönherr, N., Lozano, R., Stacherl, B.: Assessing the Impacts of higher education institutions on sustainable development—an analysis of tools and indicators. *Sustainability* **11**, 59 (2019)
- Rio+20 Higher Education Sustainability Initiative (HESI) Commitments - A Review of Progress, October (2014)
- Shriberg, M.: Institutional assessment tools for sustainability in higher education: Strengths, weakness, and implications for practice and theory. *High. Educ. Policy* **15**, 153–167 (2002)
- Dragein, A.D., De Lima, E.P., Da Costa, S.E.G.: Sustainability assessment of the service operations at seven higher education institutions in Brazil. *J. Clean. Prod.* **212**, 527–536 (2019)
- Li, Y.; Gu, Y.; Liu, C. Prioritising performance indicators for sustainable construction and development of university campuses using an integrated assessment approach. *J. Clean. Prod.* **202**, 959–968 (Quantitative Scoring Method (QSM) and Analytical Hierarchal Processes (AHP) (2018)
- Lukman, R.K.; Krajnc, D.; Glavič, P. University ranking using research, educational and environmental indicators. *J. Clean. Prod.* **18**, 619–628 (2010). Three-dimensional University Ranking (TUR)
- Bullock, G., Wilder, N.: The comprehensiveness of competing higher education sustainability assessments. *Int. J. Sustain. High. Educ.* **17**, 282–304 (2016)
- Dave, M., Gou, Z., Prasad, D., Li, F. United Nations Environment Program, 2014 Greening Universities Toolkit V2.0 (2014)
- Association for the Advancement of Sustainability in Higher Education. Star technical manual Version 2.2 June 2019. [www.aashe.org](http://www.aashe.org) Accessed Jan 2022

**Open Access** This chapter is licensed under the terms of the Creative Commons Attribution 4.0 International License (<http://creativecommons.org/licenses/by/4.0/>), which permits use, sharing, adaptation, distribution and reproduction in any medium or format, as long as you give appropriate credit to the original author(s) and the source, provide a link to the Creative Commons license and indicate if changes were made.

The images or other third party material in this chapter are included in the chapter's Creative Commons license, unless indicated otherwise in a credit line to the material. If material is not included in the chapter's Creative Commons license and your intended use is not permitted by statutory regulation or exceeds the permitted use, you will need to obtain permission directly from the copyright holder.





# Exploring the Potential of Open Source Machine Tools for Sustainable Industrial Development in Low Resource Contexts - A Case Study of Migrant-Run Microenterprises in Oman

Mohammed Omer<sup>1</sup>(✉), Melina Kaiser<sup>2</sup>, Tobias Redlich<sup>1</sup>, and Jens P. Wulfsberg<sup>1</sup>

<sup>1</sup> Helmut Schmidt University, Holstenhofweg 85, 22043 Hamburg, Germany  
mohammed.omer@hsu-hh.de

<sup>2</sup> University of Hamburg, 20146 Hamburg, Germany

**Abstract.** In low resource contexts, access to technologies is limited. Most firms in developing countries are still using analog technologies and have not attained the industrial maturity required to harness the benefits of industry 4.0, which include increased productivity and a reduced environmental impact of the manufacturing sector. This further exacerbates the unequal wealth distribution pervasive in today's globalized world. With the democratization of the internet and increasing accessibility to microcontrollers and automation technology, the last decade has seen the rise of open source machine tools (OSMT) such as CNC mills and 3D printers. By facilitating sustainable and inclusive production capacity building, OSMT are a key technology driver that can enable developing countries to leapfrog their industries. However, their potential for cost effective and low-threshold production capacity building in developing countries has been hitherto underexplored. This paper reports the findings of a pilot study in Oman with ten migrant-run microenterprises in the carpentry and steel fabrication industries. Semi-structured interviews and field observations were carried out to gain an understanding of the technology needs and readiness levels of the target group. The study identifies and discusses the challenges that could hinder the implementation of OSMT in a resource constrained context, which include insufficient technological and digital literacy, a lack of formal education, and risk adversity. Based on this, the paper proposes solutions to foster OSMT adoption.

**Keywords:** Microenterprises · Democratizing manufacturing · Open source machine tools · Resource constrained contexts · Sustainability

## 1 Introduction

Rapid globalisation has catalysed innovation and increased efficiency in manufacturing and production. It has, however, also exacerbated global technology and socioeconomic inequalities: While industrialized nations develop industry 4.0, artificial intelligence, and associated technologies, low digital resources and capabilities in developing

countries and LDCs drastically hinder the development of technical know-how, digital infrastructure, and scientific research capacities.

One promising example of enablers of more equitable and inclusive growth are the developments in the field of open source economics. No longer limited to software programs, the open source definition is now increasingly applied to physical objects, also known as open source hardware (OSHW), whereby the plans to reproduce a physical object are made freely accessible for anyone to access, use, modify, distribute, and sell [1]. Open source machine tools (OSMT) are a distinct subdomain of OSHW, whereby the build instructions, bill of materials (BOM), electronic schematics, and CAD files for machine tools are made freely available on the internet. By giving people the means and the knowhow to build their own machine tools, OSMT are a key technology driver for sustainable and inclusive industrial development in resource constrained contexts [12].

This paper uses a qualitative approach to explore the potential of OSMT in alleviating resource pressures and increase productive capacities using the example of migrant run microenterprises in Oman. Treated like temporary labour and subjected to discriminatory national policies, they often operate in the low skilled manufacturing sector and are faced with human and financial resource shortages [14]. With no initiatives or support from the government to facilitate production capacity development, they are left vulnerable to economic shocks and are unable to expand, grow or diversify their businesses. To evaluate the potential for OSMT to alleviate their resource constraints, the level of awareness of OSMT among migrant workers in the manufacturing sector in Oman is identified and the challenges that could hinder the adoption of OSMT are outlined. Owing to the highly restrictive temporary migration policies, the conditions of the migrant run microenterprises in Oman are representative of marginalized communities living in low resource contexts.

## 2 Background

### 2.1 The Role of Microenterprises in Poverty Alleviation

Representing two thirds of global employment, and 80 to 90% of the employment in developing countries, micro, small and medium enterprises (MSMEs) form the backbone of the world economy [17]. Of the three, microenterprises absorb the majority of the workforce while also making the largest relative contribution to the GDP [19]. They also play a key role in alleviating poverty, economic empowerment, and the wider distribution of wealth by enabling small-scale income generating activities and creating jobs [7]. However, they face many hurdles owing to their small size, limited resources and capacities [8]. These inadequacies make them more susceptible to economic shocks such as the disruption of global supply chains due to the COVID-19 pandemic [5].

Microenterprises are challenged on a number of fronts, including through increased competition, limited abilities to adapt to rapidly changing market demand, technological changes, and the need to innovate and be creative [4]. Successful economic development is a result of structural transformation, technological upgrading and industrialization [21]. However, microenterprises often lack the resources to invest in technology [22].



This hinders their economic development by trapping them in low value creation activities. Providing easy and affordable access to modern machine tools and automation technology will enable microenterprises to increase productivity, expand their businesses, and progress towards higher value-added sectors of industry.

## 2.2 Open Source Machine Tools (OSMT) as a Technology Driver

The term machine tools has varying definitions but is generally used to refer to forming, milling, or grinding machines with a focus on metal processing. Sometimes called “mother machines”, machine tools are directly or indirectly used to make every modern human-made object, including components required to make other machines [10]. They are therefore of fundamental importance for many different industries. Due to this, machine tools are often regarded to wield the highest impact on the productivity of whole economic systems compared to innovations in other fields [15, 16].

Innovations in machine tools, however, are highly concentrated in a few industrialized nations which are the sole producers of manufacturing technologies [2]. Most developing countries rely on buying from these centres of machine tool innovation as they do not have the necessary resources and know-how to invent and produce such technologies themselves. To do so, entrepreneurs in developing countries need high upfront capital investments. Importing machine tools into low-income countries is furthermore riddled by administrative and procedural difficulties including high customs taxes, shipping costs and other expenses. A lack of technical know-how and low technological literacy<sup>1</sup> further add to this. All in all, the high cost of purchasing and using high-tech machine tools is an insurmountable challenge for many entrepreneurs in resource constrained contexts. Therefore, even though machine tools can be regarded as decisive technology drivers for economic growth that can leapfrog developing economies, high-tech machine tools are often unattainable in developing contexts.

By applying similar principles as open source software (OSS), OSHW offers a potential solution to this problem: By making build instructions, BOMs, electronic schematics, and CAD files for machine tools freely available online, it is possible to mitigate the divide in their accessibility between industrialized and developing economies. This can strengthen bottom-up, community-driven developmental approaches [12]. Self-built machine tools can be significantly cheaper than their commercial counterparts, lowering the costs of advanced manufacturing and automation technologies that would normally be unattainable for marginalized communities in low resource contexts [13]. This could foster the growth of microenterprises by boosting productivity, reducing intensive labour, and supporting income generating activities. Moreover, by enabling the production of higher value goods, modern CNC machine tools would allow microenterprises to progress beyond low value adding manufacturing processes and compete against bigger players with higher capital, resources, and machines, resulting in equitable and inclusive industrialisation.

<sup>1</sup> Technological or technology literacy describes the ability to work with technology in different ways, from understanding over accessing and using to managing it. A certain degree of digital literacy is an important precondition to obtain technological literacy as digital devices such as computers make digital information accessible; through this, technological literacy can be fostered [20].

### 3 Migrant Run Microenterprises in Oman

With the top 10% of the population earning more than 60% of the total income, the Middle East is plagued with one of the most unequal wealth distributions in the world [6]. Oman like its GCC counterparts has a large migrant population, with most stemming from South Asian countries [3]. These migrant workers mainly work in the low paying secondary job market such as in agriculture and manufacturing with usually menial and backbreaking tasks that endanger the workers' safety [9].

With migrants seen as temporary labourers, there are little to no possibilities for them to assimilate or gain citizenship in their host countries, effectively barring them from integrating within the country's socio-economic context [23]. Trapped in low skilled occupations with minimal wages and subjected to exclusionary and discriminatory national policies, some migrant workers venture into microenterprises as an alternative source of better economic returns [14]. Among those microenterprises that focus on manufacturing, they primarily involve low skilled and labour-intensive activities using manual machine tools, in sectors such as metal fabrication, construction, and carpentry.

Migrant entrepreneurs are not eligible to receive funding from government SME financing initiatives since these are exclusively available to citizens only [18]. They therefore rely heavily on their personal savings or borrow from friends or family to start a new business or invest in machinery [14]. This makes it difficult for them to modernize, grow, or economically diversify their businesses, while also making them more susceptible to economic shocks. Lacking a supportive growth environment, migrant entrepreneurs operate in highly resource constrained contexts.

#### 3.1 Methodology

Fieldwork was carried out in Oman during February 2022 with the aim of answering two research questions: Do OSMT have the potential to boost the productive capacities of migrant run manufacturing microenterprises? What barriers hinder the adoption of OSMT?

The local industrial cluster of Wadi Kabir Sanaya in the city of Muscat, that has a predominantly dense population of migrant run microenterprises, was focused upon. Due to limited online and telecommunication opportunities of the microenterprises, interviews with the respondents were carried out face to face at their sites of business. The respondents were all male migrants from the South Asian countries of Pakistan, India, and Bangladesh. The migrant entrepreneurs were interviewed in their native languages of Urdu, Hindi, and Bengali. All interviews were transcribed and translated into English. The collected data was then subjected to in-depth qualitative content analysis.

The number of respondents interviewed was limited due to constraints in time and the unwillingness of some respondents to be interviewed. Semi structured interviews were carried out with the owners of four wood working workshops and six steel fabrication workshops. Steel fabrication and carpentry were focused upon since these comprised the majority of the migrant run manufacturing microenterprises in the industrial cluster. Oman's Ministry of Commerce and Industry classifies microenterprises as firms with 1–10 workers and an annual revenue of less than 150,000 Omani rials [11].

### 3.2 Results

The interviews and observations were conducted with a set of complementary objectives. First, the technological and educational preconditions of migrant workers were studied. This included an assessment of technical know-how and formal education to determine migrant workers' theoretical ability to independently access and replicate OSMT designs. Most of the interviewees had little to no formal education and could not read nor write in English. On the other hand, all interviewees had extensive hands-on experience with a mean of ten years in their professions. Most of the interviewees had initially been taught by family members or had obtained practical experience through informal apprenticeships in their home countries. Only few had completed formal vocational training. Interviewees did not regularly use the internet for work-related purposes and generally possessed low levels of digital literacy. This was also reflected in the fact that albeit most respondents could identify CNC technology from pictures, they themselves did not use CNC machine tools and had no knowledge about CAD/CAM technologies. It was observed that among those enterprises that did possess some machine tools, all were manual machine tools with no automation; almost all interviewees responded that processes for which CNC capabilities were required were outsourced. When asked for the reason why they did not buy a CNC machine tool, interviewees responded that they could not afford to buy a CNC machine, or their workshop lacked the space for one, or that they preferred the quality of manual machine tools over CNC machines.

Interviews then focused on determining migrant workers' awareness of and attitudes towards OSHW in general and specifically OSMT. Most interviewees had no knowledge of the concepts OSHW and OSMT but were not unfamiliar with the practicalities of the two. Several interviewees already had experience in building machines, albeit on a small scale and with simple machines that did not involve software or automation. They responded that they had built the machines from pictures of models available on the internet or by looking at machines that neighbouring shops had. When asked about their opinion on building their own machine tools, along with being more open to the idea, those interviewees that already had built small machines were also more confident in their own abilities to replicate other machines compared to those who had not built a machine. Moreover, they had a good understanding of what they would need to replicate a machine, namely detailed visual instructions of the building process.

Challenges and barriers to OSMT adoption were also considered in both interviews and observations. Key findings here were limited time and space and a lack of knowledge and experience outside of the narrowly defined fields of work done in their enterprises which could hamper both the building process and limit the benefits the interviewees might gain from the finished product. Another point identified was the fact that some interviewees did not see a necessity for automation and were content with the manual machine tools they already used. Apart from that, it was observed that most products produced in these enterprises did not require a great degree of precision. Most interviewees therefore lacked the experience for manufacturing parts with tight tolerances. This could pose a challenge for building complex machine tools with moving parts requiring precise and accurate fabrication methods.

### 3.3 Discussion

Based on the results from the interviews and observations, the needs and the potential of OSMT to increase productivity in the context of migrant run microenterprises in Oman can be derived. The reluctance of many interviewees regarding the adoption of OSMT was based on different reasons: these included limited resources including a shortage of workers, finances, knowledge, time, and space; some interviewees also did not see a necessity for modern CNC machine tools or automation. The different attitudes of migrant microentrepreneurs regarding OSMT show that they can be divided into two types, the survivalist and the opportunistic. On the one hand, reluctance to even consider the idea of increased productivity points towards risk-averse behaviour and the lack of a growth mindset which is often seen in survivalist microentrepreneurs [7]. This attitude also shows that many interviewees were unaware of the potential benefits of OSMT and how automated machine tools can increase productivity while reducing labour intensive tasks, thus using the available resources more effectively and reducing the need for increased resource input in the middle and long term. It also shows a lack of understanding of the working mechanisms and benefits of OSMT and their great variety and versatility. For example, foldable, compact, or portable machines reduce the need for additional space and make workflows more flexible. Moreover, a key benefit of self-built machine tools is that they can be designed to cater to one's exact requirements with no redundant features. This reduces costs and complexity and makes repair and maintenance easier.

Opportunistic microentrepreneurs were, on the other hand, more open towards OSMT adoption. This was particularly true for those migrant workers that had previous experience with building machines, which shows that initiatives such as educational courses and build workshops aimed at exposing migrant workers to practical experience with OSMT can lead to increased openness to OSMT adoption. They also have the potential to decrease the fear of building more complex machines and facilitate capacity building.

Regarding the accessibility of OSMT projects, it is important to recognize that low English abilities among migrant workers in Oman prohibit them from realizing most OSMT projects currently available. Most projects published online are documented in English and are strewn across various online platforms and repositories, that are often difficult to find due to keywords lacking standardization. Language barriers coupled with low digital literacy makes it almost impossible for the majority of the migrant microentrepreneurs with little formal education to access and implement these projects. To make OSMT documentation more accessible to communities like theirs, assembly documentation needs to be as language agnostic as possible. One possible solution could be IKEA style manuals whereby the documentation is limited to the use of numbers, pictures, and symbols that most people can intuitively understand. Moreover, build and user instructions that need to be in text format can be documented in a way that allows conventional browsers to automatically translate the entire page to the local language. These efforts could broaden the audience and user base of OSMT projects, thus helping the feedback and adaptation cycle.

It was difficult for some respondents to comprehend what technologies could benefit them and the only machines of reference for them were machines available locally and

those everyone else was using. Moreover, most interviewees were sceptical of what these self-built machine tools could look like. Co-creation workshops in the framework of action-based participatory research whereby the machine tool is designed, developed, and built with the end user can create awareness among the microenterprises while also empowering them. They will also shed more light on the design methodology that needs to be implemented to facilitate successful adoption of OSMT. To elevate the awareness of OSMT and overcome challenges in their adoption, future works might also study synergies from a cooperation of potential OSMT users, who lack digital literacy but have good practical knowledge, and university students, who have high formal education but might lack hands-on experience.

## 4 Conclusion

To stay relevant in a rapidly evolving global economy and become resilient in the face of pandemics, microentrepreneurs in developing countries need to modernise and diversify their technological capabilities. With significantly lower costs and freely available plans, OSMT offer an affordable and low threshold alternative for equitable, inclusive, and sustainable local production capacity building. To fulfil this potential, the challenges and barriers to OSMT adoption need to be mitigated. These range from difficulties in engineering design, social acceptance, to lacking formal education and digital literacy. Multidisciplinary approaches from the fields of engineering and social science are necessary to overcome these challenges. For example, the basic lack of awareness of the potential of OSMT could be solved by carrying our build workshops with potential end users to expose them to the concept. Appropriate engineering design would furthermore need to consider the local resources available and the constraints outlined by the end users.

**Acknowledgement.** The authors would like to thank the Center for Digitalization and Technology Research of the Bundeswehr (DTEC.bw) for their support.

## References

1. Balka, K.: Open source product development. The meaning and relevance of openness. Zugl.: Hamburg-Harburg, Techn. Univ., Institut für Technologie- und Innovationsmanagement, Diss., 2011. Forschungs-, Entwicklungs-, Innovations-Management. Gabler, Wiesbaden (2011)
2. Békés, G., Harasztsosi, P.: Machine imports, technology adoption, and local spillovers. *Rev. World Econ.* **156**(2), 343–375 (2019). <https://doi.org/10.1007/s10290-019-00365-y>
3. de Bel-Air, F.: Demography, migration, and the labour market in Oman (2015)
4. Duncombe, R.: Using the livelihoods framework to analyze ICT applications for poverty reduction through microenterprise. *Inf. Technol. Int. Dev.* **3**(3), 81–100 (2007)
5. Fabeil, N.F., Pazim, K.H., Laggat, J.: The Impact of COVID-19 Pandemic Crisis on Micro-Enterprises: Entrepreneurs' Perspective on Business Continuity and Recovery Strategy (2020)

6. Harris, K.: Divergent histories and converging inequalities in the Middle East and Latin America. Middle East Report, 284/285 (2017)
7. Harvie, C.: The Contribution of Micro-enterprises to Economic Recovery and Poverty Alleviation in East Asia
8. Harvie, C.: Micro-, small- and medium-sized enterprises (MSMEs): challenges, opportunities and sustainability in East Asia. In: Jayanthakumaran, K., Shukla, N., Harvie, C., Erdenetsogt, O. (eds.) Trade Logistics in Landlocked and Resource Cursed Asian Countries, pp. 155–174. Springer, Singapore (2019). [https://doi.org/10.1007/978-981-13-6814-1\\_7](https://doi.org/10.1007/978-981-13-6814-1_7)
9. Jureidini, R.: Global governance and labour migration in the GCC. In: Pal, L.A., Tok, M.E. (eds.) Global Governance and Muslim Organizations. IPES, pp. 339–364. Springer, Cham (2019). [https://doi.org/10.1007/978-3-319-92561-5\\_14](https://doi.org/10.1007/978-3-319-92561-5_14)
10. Mori, M., Hansel, A., Fujishima, M.: Machine tool. In: Laperrière, L., Reinhart, G (eds) CIRP Encyclopedia of Production Engineering, pp. 792–801. Springer, Cham (2014). [https://doi.org/10.1007/978-3-642-20617-7\\_6533](https://doi.org/10.1007/978-3-642-20617-7_6533)
11. Oman News Agency. Ministerial Decision Amends Classification of SMEs Per Workforce, Revenues. <https://omannews.gov.omtopics/en/79/show3482light>. Accessed 15 April 2022
12. Omer, M., Kaiser, M., Moritz, M., Buxbaum-Conradi, S., Redlich, T., Wulfsberg, J.P.: Democratizing Manufacturing – Evaluating the Potential of Open Source Machine Tools as Drivers of Sustainable Industrial Development in Resource Constrained Contexts. Institutionelles Repositorium der Leibniz Universität Hannover, Hannover (2022)
13. Open Source Ecology. GVCS Cost Comparison to Industry Standards - Open Source Ecology. [https://wiki.opensourceecology.org/wiki/GVCS\\_Cost\\_Comparison\\_to\\_Industry\\_Standards](https://wiki.opensourceecology.org/wiki/GVCS_Cost_Comparison_to_Industry_Standards). Accessed 26 April 2022
14. Rahman, M.M.: ISAS-Working-Papers-No.-281-Development-of-Migrant-Businesses-in-Saudi-Arabia (2018)
15. Rosenberg, N.: Inside the black box. Cambridge University Press, Cambridge, Technology and economics (1983)
16. Saxena, P.K., Sharma, A.: Role of machine tool industry in economic development. ISSN 3(5), 188–193 (2014)
17. Secretary General. Entrepreneurship for sustainable development. Report of the Secretary-General. Sustainable Development (2020)
18. SMEF. 2014. *SME Development Fund Oman*. <https://www.smefoman.com/vision-mission.html>. Accessed 24 April 2022
19. Suhaili, M. and Sugiharsono, S. 2019. Role of MSME in Absorbing Labor and Contribution to GDP. *I 8, 3*, 301–315
20. Technology for All Americans Project and International Technology Education Association. 2002. Standards for technological literacy. Content for the study of technology. International Technology Education Association, Reston
21. United Nations Economic and Social Council. Industry 4.0 for inclusive development (2022)
22. Verma, P.A.: Why technology is the only path to sustained growth for MSMEs. Economic Times (Jan. 2021)
23. Weeraratne, B.: Return and reintegration without assimilation: South Asian migrant workers in the gulf during COVID-19 (2020)

**Open Access** This chapter is licensed under the terms of the Creative Commons Attribution 4.0 International License (<http://creativecommons.org/licenses/by/4.0/>), which permits use, sharing, adaptation, distribution and reproduction in any medium or format, as long as you give appropriate credit to the original author(s) and the source, provide a link to the Creative Commons license and indicate if changes were made.

The images or other third party material in this chapter are included in the chapter's Creative Commons license, unless indicated otherwise in a credit line to the material. If material is not included in the chapter's Creative Commons license and your intended use is not permitted by statutory regulation or exceeds the permitted use, you will need to obtain permission directly from the copyright holder.



# **Assessment, Strategy and Business Models**





# Holistic Approach to the Ecological Evaluation of Digitalization Systems in the Production Environment

Florian Tomaschko<sup>(✉)</sup> and Sandra Krommes

Technical University of Applied Science Rosenheim, 83024 Rosenheim, Germany  
{florian.tomaschko,sandra.krommes}@th-rosenheim.de

**Abstract.** Digitalization is considered as a driver of resource efficiency. But next to the possible savings that the different digitalization technologies enable, there is an ecological effort, too. Most of the existing approaches in this topic only consider the possible savings. The presented methodology forms an approach for a holistic environmental assessment along the whole life cycle of digitalization technology and validates it on a demonstrator. The aim is to take an end-to-end view of the use of digitalization technologies. As part of the approach, the global warming potential is evaluated. The benefit here is a production environment in which the digitalization technology used generates savings. For the evaluation, the digitalization system (hardware) is considered from the manufacturing process of the different components through transport and operation to recycling (cradle to grave). As practical case study, effort and benefit are finally analyzed for different resource efficiency scenarios. As a result, a methodical approach based on key figures for the holistic evaluation of digitalization technologies is presented and discussed.

**Keywords:** Digitalization of production systems · Holistic ecological evaluation · Woodworking

## 1 Motivation for Research

As a part of the digitalization of production systems, the use of Industry 4.0 technologies (for example digital twins, cyber-physical systems and cyber-physical production systems) offers a wide range of options for optimizing manufacturing processes [1–3]. In addition to improving product and process quality, predictive maintenance or self-controlled production systems, one of these options is to increase the (resource) efficiency [4, 5]. In general, the use of digitalization technologies has the potential to raise efficiency up to 50% and save costs and resources in production [6, 7]. There are several approaches that focus on increasing resource efficiency by using digitalization technology [8–10]. Mabkhot et al. 2021 analyzed that digitalization and industry 4.0 technology can contribute to achieving the sustainability development goals of the UN (i.a. industry, innovation and infrastructure; climate action; responsible consumption and production) [11]. Most of these methods and studies represent the development, the

use or the implementation in the manufacturing process and only evaluate the potential savings [12]. However, the used technologies, in turn, generate environmental impacts during their production, operating and recycling phases. A comprehensive evaluation of this in relation to the savings is not considered but needed in case of the current raw material situation and climate change.

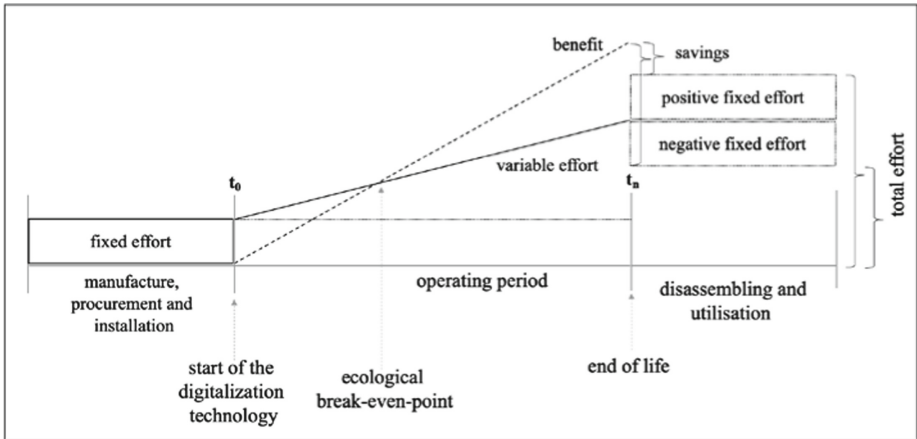
## 2 State of Research

There exist various approaches and methods that focus on resource efficiency and digitalization. A significant part of them handles the advantages that digitalization brings with it to increase resource efficiency, relates to the use of specific technologies and describes the possible saving potential [13–17]. A holistic assessment about a comparison of the saving possibilities with the resources to be used only takes place in exceptional cases [18]. Thiede 2018 and Schebeck et al. 2017 describe methods to holistically assess environmental impact of digitalization technologies [19, 20]. Thiede 2018 focuses on cyber-physical production systems (CPPS) and describes that their use leads to increasing environmental pollution. Therefore, a holistic assessment of the environmental impact is necessary. This environmental pollution is offset by possible positive effects. To this problem, Thiede compares manufacturing systems before and after the use of CPPS, calculates an environmental break-even point and forecasts the different environmental impacts of the two systems. Thiede made assumptions for the calculation and did not carry out a holistic evaluation (cradle-to-cradle). He recommends expanding the methodology accordingly [19]. Based on the VDI 4800, Schebeck et al. 2017 conducts various case studies about resource efficiency through digitalization. To measure sustainability, comprehensive eco-balance studies are necessary, which provide a comprehensive picture of the environmental impact. If possible, both the positive and the negative environmental impacts are compared and quantified in the case studies. A consistent and holistic accounting does not take place [20].

There is a need to develop methods for holistic balancing, which consider all life cycle phases of the relevant technology. In addition, approaches are needed that are based on existent key figures and ensure applicability in the industrial environment, so that statements can be made about the ecological sense of an investment. Addressed scaling problems (expansion of digitalization technology) and the simplified representation of linear saving curves should be considered.

## 3 Methodological Approach

A sustainable production is characterized as a system that improves positive and reduces negative environmental parts [21]. For a holistic evaluation of investment decisions in digitalization technology, the achievable benefit and the related negative effort, must be considered. The benefit will be generated in the manufacturing systems in which the digitalization technology is used. For example, Benchmarking and KPI-based monitoring can reduce energy consumption, increase product quality (reduce reject rate) or reduce CO<sub>2</sub>-emissions [10]. The effort arises from the production, transport, operation and recycling of the digitalization components (Fig. 1).



**Fig. 1.** Effort and benefit during the life cycle

The theoretical assumption is based on the simplified approach of the linear effort and benefit curves. In practice, different curves are to be expected over the life cycle. For the benefit system a declining and a progressive curve can be possible. A declining curve progression occurs in systems with a previously low (or no) degree of digitalization. In these systems, there is a large increase in benefit right at the start, which comes up to a saturation over the operating time (quick wins). For systems that follow a learning effect, a progressive benefit curve is to be expected. At the beginning there are small savings, which increase during the learning effect. The curve progression influences the ecological amortization period. Compared to the linear savings, a declining curve has a positive effect on the payback period and a progressive curve has a negative effect. A 3-stage scheme is proposed to evaluate the ecological advantages of a digitalization investment.

### Step 1: Defining the Framework Conditions

To determine the environmental impacts of the technology, the environmental impact categories and the specific system boundaries for the effort and benefit system must be defined in step one. Only those categories that are influenced by both systems are suitable as influence categories. On the one hand, savings must be possible during the use of the technology in the benefit system and on the other hand an assessment by the effort system must be possible, too. For the following explanations, the global warming potential, the cumulative energy consumption and the cumulative consumption of raw materials are considered. Other suitable categories for consideration must be verified separately but can be useful. In addition to the influence categories, a specific system boundary must be defined for each of the two systems in accordance with the requirements of DIN EN ISO 14040/44 [22]. For the benefit system, an isolated consideration of the specific manufacturing process is recommended. A comprehensive consideration of the

effort-system, with all relevant environmental impacts along the product life cycle from production to recycling (cradle to cradle) is essential for the holistic assessment.

### Step 2: Calculation of the Environmental Impact

The environmental impacts are calculated separately for the categories selected in stage one. To calculate the cumulative values, the maximum lifetime of the digitalization technology is assumed to be 10 years (requirement: remaining lifetime of the production machine to be digitalized > 10 years). The impact categories can be calculated with the life cycle assessment method in accordance with DIN EN ISO 14040/44 [22]. To calculate the effort of the digitalization technology, the fixed effort from production and from recycling (positive or negative) and the variable effort during the operating time (depending on the operating hours of the technology) must be considered as shown in Fig. 1. The benefit depends on possible savings accumulated over the defined total operating time. Different scenarios can be created for different saving/benefit levels. The savings are calculated from the difference between the consumption or generation of environmental impacts before the digitalization and the change after the digitalization.

### Step 3: Evaluation of the Ecological Sense

The determined efforts and benefits can be constituted by key figures and enable an evaluation or comparison of the investments in digitalization technology. Two key figures are combined for the presented methodology. An essential feature of the selected key figures is their suitability for decision support and control to provide decision-makers with the essential information in a targeted and understandable manner [23–27]. Using the key figure resource efficiency, the benefit level can be calculated. This marks the ecological limit point, from when digitalization technology is ecologically beneficial [28].

$$\text{Resource efficiency} = \frac{\text{benefit}}{\text{effort}} \quad (1)$$

Within this perspective, three scenarios are possible (Fig. 2).

Depending on the scenario, a pre-selection can be made as to whether an investment makes sense. A further specification or a ranking between different investment alternatives is provided by the key figure ecological repayment period [29].

$$\text{Ecological repayment period} = \frac{\text{damage caused by the investment}}{\text{annual pollutant savings during use}} \quad (2)$$

Once the key figures have been formed, a statement can be made on the ecological sense and a recommendation given regarding the investment in digitalization technology. After the investment has been made, a target-performance comparison of the calculated and the actual values is recommended. In case of discrepancies can be counteracted accordingly or the database can be improved for further decisions.

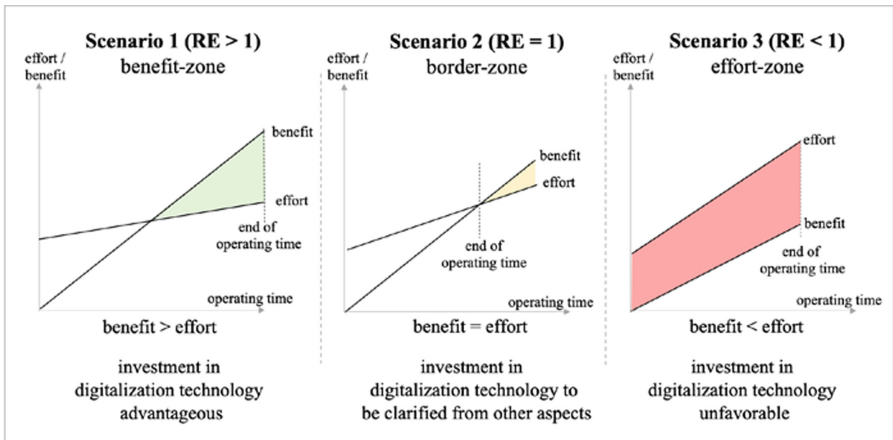


Fig. 2. Resource Efficiency Scenarios

### 4 Case Study on a Woodworking Process

The Technical University of Rosenheim operates the production tomorrow laboratory (proto\_lab). This consists of industrial furniture production and includes three wood-processing machines (panel saw, edge banding machine and CNC processing center) [30]. This wood-technical production process (benefit system) was subsequently equipped with digitalization technology (effort system) and (costs), energy and resources can be saved. The upgrade includes a hardware measuring system (per machine), data-transmission, -storage and -evaluation. The created cyber-physical system records data every 250 ms (energy, compressed air and exhaust air, machine data and data from the Manufacturing-Execution-System) and evaluates it (Fig. 3).

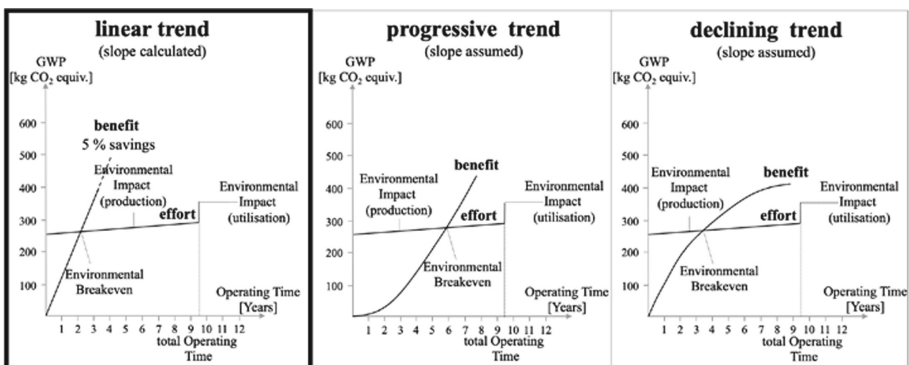


Fig. 3. Holistic environmental assessment of the Case study

To calculate, saving scenarios were generated (by using the cyber-physical system) for greenhouse gas emissions and electrical energy (including compressed air and

exhaust air, normalized to electrical energy) in steps of 5% - 25%. Therefore, it was assumed that the production (including all upstream chains) of the components takes place in China. The system requires 10.5 W of electrical energy per hour to operate. Operation only takes place together with the production process in a two-shift working period and includes 36,800 operating hours (including production time, set-up time, downtime, disruption time). This results in a total consumption of 38.5 kWh during the usage phase (maintenance-free system). Recycling takes place within a radius of 100 km from the production plant. A full disassembly analysis was realized to analyze the system. During the use of the cyber-physical system 280 kg of CO<sub>2</sub>-equivalent are generated. In contrast to this, there are 29,000 kg of CO<sub>2</sub>-equivalent that are generated during the entire service life of the production. The resource efficiency is positive for all saving scenarios (assuming a linear progression). With the current data, no curve slope can be calculated for the progressive and for declining curves. In the manufacturing process under consideration, the savings are achieved by reducing compressed air consumption and optimizing the manufacturing program for drilling and milling. In addition, further savings can be achieved by monitoring the saw blade (reduction of rejects). To evaluate this, the cumulative consumption of raw materials should be considered. For the 5% saving, the assumption of the linear progression is correct. This could be confirmed by test runs. Savings over 10% require new digitalization-technology, such as artificial intelligence applications (planned). These lead to the expectation of a progressive curve, which entails a changed ecological amortization period as well as changing effort and benefit curves. If only the GWP is considered, the installed digitalization-technology (under the assumptions considered) is advantageous.

## 5 Conclusion and Further Work

The presented methodology allows to evaluate digitalization investments according to their ecological usefulness. This is urgently needed due to the current raw material situation and climate change. Using a 3-stage approach, environmental aspects can be included in decisions. In addition to strategic aspects which make digitalization of production necessary, the method offers key figures for ecological evaluation. The evaluation on a research demonstrator confirms the practicability of the method. The methodology should be critically examined and further developed from the following aspects.

Due to the currently possible consideration of the GWP, a holistic assessment takes place, but decisions regarding the usefulness can only be made one-dimensionally. An expansion of the consideration to include several impact categories is planned. In addition, a decision matrix is required that allows statements to be made about investment-decisions and -comparisons, including economic criteria.

For industrial applications, the consideration of the effort system must be expanded to include software-related influences. Otherwise, a comprehensive consideration and decision is not possible. This allows questions regarding IT capacities (internal vs. external, central vs. decentralized, server vs. cloud). First activities that show the environmental influences of IT-technology already exist [31–33].

The presented methodology was tested and evaluated in the research environment. A planned further development and evaluation should take place in the industrial environment (series production). Solutions for the allocation of non-productive machine

times should be developed. In addition, for practicality it is necessary to collect data that can be used to create standardized effort models. This would significantly reduce the calculations effort.

Furthermore, the savings and expenses are calculated based on the current situation. Regarding changing framework conditions in the future, there is a need of considerations of dynamic calculation (like discounting in cost accounting) [34].

## References

1. Dillinger, F., Bernhard, O., Kagerer, M., Gunther, R.: Industry 4.0 implementation sequence for manufacturing companies. *Prod. Eng.* **16**, 705–718 (2022)
2. Bauernhansl, T., ten Hompel, M., Vogel-Heuser, B. (eds.): Springer, Wiesbaden (2014). <https://doi.org/10.1007/978-3-658-04682-8>
3. Veile, J.W., Kiel, D., Müller, J.M., Voigt, K.-I.: Lessons learned from Industry 4.0 implementation in the German manufacturing industry. *J. Manuf. Technol. Manag* (2019)
4. Biedermann, H., Topic, M.: Digitalisierung im Kontext von Nachhaltigkeit und Klimawandel – Chancen und Herausforderungen für produzierende Unternehmen. In: Sihn-Weber, A., Fischler, F. (eds.) *CSR und Klimawandel. MCSR*, pp. 41–62. Springer, Heidelberg (2020). [https://doi.org/10.1007/978-3-662-59748-4\\_4](https://doi.org/10.1007/978-3-662-59748-4_4)
5. Neligan, A., Schmitz, E.: Digitale Strategien für mehr Materialeffizienz in der Industrie. *IW-Report 3/2017*, Institut der deutschen Wirtschaft Köln, Köln (2017)
6. Plass, C.: *Industrie 4.0 ALS Chance begreifen (Opportunnity Fakten für Experten und Entscheider)*. Berlin: Unity AG (2015)
7. Krommes, S., Tomaschko, F.: Zwischenbericht zum Forschungsprojekt ReFer Ressourceneffizienz durch digitale Wert- und Stoffstrommodellierung in Fertigungsprozessen,” Technische Hochschule Rosenheim (2020)
8. Leiden, A., Herrmann, C., Thiede, S.: Cyber-physical production system approach for energy and resource efficient planning and operation of plating process chains. *J. Clean. Prod.* **280** (2021)
9. Liang, Y., Lu, X., Li, W., Wang, S.: Cyber physical system and big data enabled energy efficient machining optimisation. *J. Clean. Prod.* **187**, 46–62 (2018)
10. Krommes, S., Tomaschko, F.: Chance für mehr Ressourceneffizienz. *Zeitschrift für wirtschaftlichen Fabrikbetrieb* **116**, 58–63 (2021)
11. Mabkhot, M.M., et al.: Mapping Industry 4.0 enabling technologies into United Nations sustainability development goals. *Sustainability* **13**(5), 2560 (2021)
12. Tomaschko, F., Annan, K., Krommes, S.: Digitalisierung der Produktion: Ganzheitliche Bewertung: Kennzahlen zur ökonomischen Bewertung der Digitalisierung in der Produktion (Brownfield-Ansatz). *Zeitschrift für wirtschaftlichen Fabrikbetrieb* **117**(5), 321–326 (2022)
13. Rojek, I., Dariusz, M., Ewa, D.: Digital twins in product lifecycle for sustainability in manufacturing and maintenance. *Appl. Sci. Basel.* **11**(1) (2021)
14. JuneHyuck, L., Sang Do, N., Hyun-Jung, K., Yong-Shin, K.: Implementation of cyber-physical production systems for quality prediction and operation control in metal casting. *Sensors* **18**(5), 1428 (2018)
15. Tabar, R.S., Wärmefjord, K., Söderberg, R.: A method for identification and sequence optimisation of geometry spot welds in a digital twin context. *J. Mech. Eng, Sci.* **233**, 1–11 (2016)
16. Leng, J., et al.: Digital twin-driven rapid reconfiguration of the automated manufacturing system via an open architecture model. *Rob. Comput. Integrat. Manuf.* **63** (2020)

17. Trauer, J., Pfungstl, S., Finsterer, M., Zimmermann, M.: Improving production efficiency with a digital twin based on anomaly detection. *Sustainability* **13**(18) (2021)
18. Bamunuarachchi, D., Georgakopoulos, D., Banerjee, A., Jayaraman, P.P.: Digital twins supporting efficient digital industrial transformation. *Sensors* **21**, 6829 (2021)
19. Thiede, S.: Environmental sustainability of cyber physical production systems. Presented at the 25th CIRP Life Cycle Engineering (LCE) Conference, Copenhagen, Denmark (2018)
20. Schebek, L., et al.: Ressourceneffizienz durch Industrie 4.0: Potenziale für KMU des verarbeitenden Gewerbes. VDI ZRE, Berlin (2017)
21. Garretson, I.C., Mani, M., Leong, S., Lyons, K.W., Haapala, K.R.: Terminology to support manufacturing process characterization and assessment for sustainable production. *J. Clean. Prod.* **139**, 986–1000 (2016)
22. DIN EN ISO 14040 Umweltmanagement - Ökobilanz - Grundsätze und Rahmenbedingungen (2021)
23. Horváth, P., Gleich, R., Seiter, M.: *Controlling*. Franz Vahlen, Stuttgart (2015)
24. Steger, J.: *Kennzahlen und Kennzahlensysteme*. NWB Verlag GmbH & Co. KG, Stuttgart (2014)
25. Reichmann, T., Kißler, M., Baumöl, U.: *Controlling und Kennzahlen*. Franz Vahlen Verlag, Dortmund (2017)
26. Dietrich, E., Schulze, A., Weber, S.: *Kennzahlensystem für die Qualitätsbeurteilung in der industriellen Produktion*. Hanser Verlag, Weinheim (2007)
27. Meyer, C.: *Betriebswirtschaftliche Kennzahlen und Kennzahlen Systeme*. Verlag Wissenschaft und Praxis Dr. Brauner GmbH, Stuttgart (2011)
28. VDI 4800 Blatt 1 Ressourceneffizienz - Methodische Grundlagen, Prinzipien und Strategien (2016)
29. Sailer, U.: *Nachhaltigkeitscontrolling*. UVK Verlag, München (2020)
30. TH-Rosenheim. "proto\_lab production tomorrow laboratory " Technische Hochschule Rosenheim. <https://protolab-rosenheim.de>. Accessed 16 May 2022
31. Gröger, J., Liu, R., Stobbe, L., Druschke, J., Richter, N.: Green cloud computing lebenszyklusbasierte datenerhebung zu umweltwirkungen des cloud computing. In: "Abschlussbericht," Dessau-Roßlau, 2021, vol. 94 (2021)
32. Gröger, J.: Digitaler CO<sub>2</sub>-Fußabdruck Datensammlung zur Abschätzung von Herstellungsaufwand, Energieverbrauch und Nutzung digitaler Endgeräte und Dienste. Öko-Institut e.V, Berlin (2020)
33. Schien, D., Coroama, V.C., Hilty, L.M., Preist, C.: The energy intensity of the internet: edge and core networks. In: Hilty, L.M., Aebischer, B. (eds.) *ICT Innovations for Sustainability*. AISC, vol. 310, pp. 157–170. Springer, Cham (2015). [https://doi.org/10.1007/978-3-319-09228-7\\_9](https://doi.org/10.1007/978-3-319-09228-7_9)
34. Schuster, T., Rüdert von Collenberg, L.: Investitionsrechnung. In: *Kapitalwert, Z., Annuität, A.* (eds.) Springer-Verlag GmbH Deutschland, Mannheim (2017). <https://doi.org/10.1007/978-3-642-54622-8>



**Open Access** This chapter is licensed under the terms of the Creative Commons Attribution 4.0 International License (<http://creativecommons.org/licenses/by/4.0/>), which permits use, sharing, adaptation, distribution and reproduction in any medium or format, as long as you give appropriate credit to the original author(s) and the source, provide a link to the Creative Commons license and indicate if changes were made.

The images or other third party material in this chapter are included in the chapter's Creative Commons license, unless indicated otherwise in a credit line to the material. If material is not included in the chapter's Creative Commons license and your intended use is not permitted by statutory regulation or exceeds the permitted use, you will need to obtain permission directly from the copyright holder.





# Development of a Sustainability Strategy for Fuel Cells Using Life Cycle Analysis and Expert Interviews

Patrick Rückert<sup>(✉)</sup>, Aigul Khabipova, and Kirsten Tracht

University of Bremen, Badgasteiner Street 1, 28359 Bremen, Germany  
rueckert@bime.de

**Abstract.** Fuel Cells (FC) are one of the most promising technologies for achieving the European climate targets, especially for future mobility. As part of the German government's national hydrogen strategy, measures for the further development and implementation of FC technology as a drive technology in automobiles as well as the production and use of hydrogen were adopted in June 2020. For Germany to be a pioneer in the field of FC technology, the investments must be used sustainably. The objective of this paper is to introduce a sustainability strategy for FCs along the life cycle via production, energy sources, infrastructure, use as well as end-of-life. To present an overview of this existing value chain, life cycle analyses are compared and hypotheses for increasing sustainability are formulated. These serve as the basis for the development of interview forms for discussions with FC experts from research, industry, and politics. Based on the current state of the art and its optimization potential as well as the insider knowledge of the experts, a sustainability strategy for FC-powered automobiles is presented.

**Keywords:** Fuel Cells · Life cycle analysis · Sustainability

## 1 Introduction

Looking back at the last decade, the automotive industry is under increasing pressure to develop innovative and environmentally friendly drive technologies. In order to realize the ambitious and regulatory framework conditions of carbon dioxide reduction (CO<sub>2</sub>) by the year 2030, research is being conducted into electrifying drive solutions. The future viability of fuel technology is controversially discussed in this context [1].

When comparing the sustainability of different drive technologies, life cycle analyses are carried out in which the occurring CO<sub>2</sub> emissions are considered along the manufacturing, utilization and recycling phases. With regard to the utilization phase, battery- and hydrogen-powered electric vehicles do not emit any direct emissions [2].

In this context, the sustainability of passenger cars and light commercial vehicles is measured on the basis of the CO<sub>2</sub> emissions emitted during the utility phase in grams per kilometer, with high penalties having to be paid if set limit values are exceeded [3]. On July 14, 2021, the EU Commission presented a ban on the sale of new cars with internal combustion engines from 2035 in its climate plans.

In order to maintain competitive in drive technologies, the field of future Fuel Cell (FC) technology must be caught up. Existing obstacles along the lifecycle must be analyzed and proposals for action must be made. In order to be able to use FC technology sustainably and comprehensively and thus contribute to more climate-friendly mobility, the potential for optimization along the FC life cycle must be continuously analyzed. With the help of questions on the weaknesses of the technology with interview partners from research, industry and politics, concrete measures for action are to be developed within the framework of a strategy paper. Within the framework of this paper, a sustainability strategy is developed, in which proposals for action are listed for achieving the selected milestones for increasing the sustainability of FCs. These proposals for action are primarily intended to answer the research questions of CO<sub>2</sub> emission reduction and the sensible use of automobiles powered by hydrogen. The strategy paper results from the knowledge gained from the life cycle meta-study as well as the analyzed interview responses from FC experts. The strategy paper is intended to provide an overview of the aspects of sustainability enhancement along the FC life cycle.

## 2 Life Cycle Analysis on Fuel Cells

Life cycle analysis is used to record and assess the environmental impact from cradle to grave, i.e. from the extraction of raw materials to the manufacture, use and disposal of the product. The method of life cycle analysis aims to provide information on resource consumption and emerging pollutant emissions from product manufacture, usage and disposal. Life cycle analysis consider possible environmental damage over the entire product life cycle and are used for decision-making. The standardization of the LCA methodology was recorded by the International Organization for Standardization within the framework of the ISO 14040 (ISO 2006a) and ISO 14044 (ISO 2006b) standards. In the following, 13 life cycle analyses that are relevant for FCs are further analysed. Studies with life cycle analyses published in the period 2015–2021 are examined. In addition to fuel cell drives, the life cycle analyses examined other drive technologies in order to make a comparison with conventional or purely electric drives. A further meta-analysis is necessary since no life cycle analysis covers the emissions of all five life cycle phases of an automobile with PEM fuel cell drive.

According to an analysis by SIMONS, achieving large reductions in the life cycle emissions of FC vehicles (FCVs) requires that the environmental impacts are consistently lower than for internal combustion vehicles (ICVs). The analysis shows very clearly that powering FCVs with hydrogen produced from fossil resources (directly or indirectly via electrolysis) offers no environmental benefits compared to gasoline vehicles from a life cycle perspective [4].

Platinum and carbon fibers were identified by MIOTTI et al. as the most important sources of environmental impact in FCVs. For platinum, a combined effort to reduce pollution and increase recycling rates can significantly reduce these impacts. For carbon fibers, recycling becomes more problematic. Therefore, a reduction in material use and a simultaneous increase in production efficiency will have to occur [5].

According to LI et al., the well-to-wheel (WTW) energy efficiency of FCVs using hydrogen from solar solid oxide electrolysis cell (SOEC), solar thermochemical, and nuclear SOEC systems is comparable to that of Battery electric vehicles BEVs [6].

Favorable results were calculated by AHMADI et al. for switching from conventional gasoline vehicles to hydrogen FCVs, based on a significant reduction in greenhouse gas emissions (72%), complemented by significantly reduced life-cycle fuel costs. In addition, FCVs have no harmful emissions during vehicle operation, which could contribute to a noticeable improvement in air quality in urban areas. The estimated life-cycle energy consumption of the hydrogen FCV was 21% higher than that of the gasoline vehicle due to the higher energy required for hydrogen production, distribution, and delivery, as well as for the vehicle's material production [7].

The results of a study by PREVEDEOUROS reinforce the position that transportation policy should be dynamic to reflect changes in vehicle fleet and regional data, to support clean technologies and renewable energies, and to complement existing transportation regulations. FCVs have the lowest CO<sub>2</sub> emissions at 260 g per passenger-mile [8].

The environmental benefits of using hydrogen in the use phase of the FCV were highlighted by EVANGELISTI et al. The FCV shows significant advantage in the utility phase compared to the other technologies. However, the reduction of environmental impact in the production of FCVs is necessary. It is still an important challenge that needs to be addressed in the coming years [9].

In 2030, according to MEYER et al. the platinum demand for the FCVs and the catalytic converters is ca. 110 tons. Platinum is already very well recycled today. Global platinum demand is covered to 23% from secondary material. The end-of-life recycling rate for platinum in the vehicle sector is over 50%. The use of recycled material originating from the mobility sector significantly dampens the demand for primary material [10].

The hydrogen FCV selected for the study by KARAASLAN et al. did not show any promising advantages over combustion engine propulsion, either in terms of emissions or consumption. This is due to the fact that the process of hydrogen production emits a considerable amount of greenhouse gases even when using the energy path of electrolysis as opposed to the combustion of natural gas. In addition, the electricity used in this pathway is converted to hydrogen and then back to electricity within the fuel stacks, making this energy pathway much less efficient than that for electric vehicles [11].

An analysis by ZAPF et al. shows that, except for THG emissions, there has already been a significant reduction in passenger-mile or specific car emissions in Germany in the past. The CO<sub>2</sub> emission reduction of about 15% was cancelled out by 2017 by an increase in passenger car traffic in Germany, so that total CO<sub>2</sub> emissions from passenger car traffic increased by 0.5% between 1995 and 2017 [13].

The study by the Fraunhofer Institute for Solar Energy Systems ISE identified in its life cycle analysis that FC cars are the most climate-friendly. Here, the emissions for passenger vehicles of different drives were compared over a mileage of 150,000 km [12].

The more the share of renewable energy increases, the production costs of FCVs decrease, and the required range of BEVs increases, the more the competitiveness of FCVs increases compared to BEVs in terms of cost and environmental impact. Provided that the electricity mix has a low CO<sub>2</sub> intensity, it is recommended to promote BEVs for short-distance and delivery transport (e.g. parcel services) and FCVs for long-distance passenger and freight transport [13].

According to COX et al., only in areas with very clean electricity (below 200 g CO<sub>2</sub>eq/kWh) do FCVs powered by hydrogen from electrolysis offer climate benefits compared to ICVs [14].

Based on the assumption that there will be 100% renewable energy generated by today's plants in 2050, according to LOZANOVSKI et al. the Catenary electric vehicle has the lowest greenhouse gas emissions, followed by the BEV. The FCEV is in the middle range and the internal combustion vehicles have the highest GHG values [15].

### 3 Hypotheses for Sustainability Optimization

Based on the state of the art and the comparison of the life cycle analyses, three hypotheses are established for each life cycle step. The selected hypotheses are discussed with experts through directed questions. In case of validation, strategy points can be drawn inferentially from the hypothesis. In Table 1, three potential hypotheses per life cycle phase are explained. The prioritization (1–3) is based on a qualitative literature analysis and serves to focus a hypothesis and thus strategy approach. Regards to the extensive subject area and the diverse backgrounds of the experts and stakeholders, a draft strategy for increasing the sustainability of the entire life cycle can be defined in a targeted and comprehensible manner. This minimizes the risk of deviation from the overall topic and a one-sided focus on certain phases. The hypotheses that have not been prioritized can be scientifically processed by means of an empirical investigation and a selection of further experts.

**Table 1.** Hypotheses for each life cycle step.

Life cycle step	Nr.	Hypothesis
Production (FC manufacturing)	1	Increased knowledge sharing promotes mass production and FC price reduction through scaling whereby concepts for smart production as well as energy management reduce emissions during production
	2	Standardization of the metal-based bipolar plate material would shift funding and thereby realize mass production as quickly as possible and simplify recycling
	3	Platinum reduction in the catalyst using alloy nanoparticles would sustainably reduce emissions generated during production
Hydrogen generation	1	The expansion of renewable energies is behind its forecasts and is hindering the sustainable production of green hydrogen

(continued)

**Table 1.** (continued)

Life cycle step	Nr.	Hypothesis
	2	In addition to green hydrogen, turquoise, blue, and pink hydrogen are needed for a transition phase to meet the 1.5 °C climate target
	3	Cross-sectoral demand for hydrogen in chemistry, transport, heat and energy leads to distribution conflicts, Hydrogen shortages and high purchase prices
Hydrogen infrastructure	1	Hydrogen infrastructure is monopolistically managed and realized more slowly than necessary
	2	Fueling station concepts that ensure energy supply for all propulsion technologies will lead to the independence of the infrastructure regarding future mobility development
	3	Knowledge generated by the position as a hydrogen nation can be marketed as an export commodity independent of local development
Utilization (End-User)	1	An either/or decision between battery and FC drive technology leads to an unobjective discussion that hinders synergy effects within electromobility
	2	Due to the high price of current FC-powered car models and the low supply on the used car market, they are not relevant for a customer when making purchasing decisions
	3	A lack of a sharing mentality hardly allows business cases for sharing automobiles
End-of-Life	1	The lack of hydrogen infrastructure abroad hinders the sustainable reuse of automobiles
	2	Synergies between battery and FC recycling are not exploited
	3	Recycling companies invest hardly any research and development funds in recycling processes of PEM FCs, which is why they are not prepared for increasing FC returns

## 4 Expert Interviews and Strategies on Fuel Cells

As part of the expert selection process, a total of 54 potential interview partners were contacted and requested for an interview with a brief introduction to the research project. Thirteen experts agreed to an interview (Table 2). In selecting the individual experts, attention was paid to the diversity of the fields of action of the various players.

Various hypotheses for increasing the sustainability of the PEM FC life cycle emerged from the state of the art and the comparison of the life cycle analyses (Table 1). The interview questionnaires developed and interviews conducted serve to collect internal knowledge from the experts with regard to the hypotheses established. The interview questions were adapted to the expertise of the respective expert.

The statements of the interview partners are assigned to the categories of production, hydrogen production, hydrogen infrastructure, utilization and end-of-life. In a qualitative content analysis, an evaluation of expert statements is carried out and measured on the basis of internal and external quality criteria. The internal quality criteria include inter-subjective comprehensibility, credibility, regularity, and auditability. External quality is measured by the possibility of generalization and transferability.

The composition of the elements from the state of the art, the meta-study of the life cycle analyses and the expert interview statements results in strategy points and milestones. In terms of a holistic approach, the areas of production, hydrogen generation and infrastructure, utilization and end-of-life are considered for strategy points and milestones (Fig. 1). For the elaboration of the strategy points, the knowledge gained from the state of the art, the meta-study of the life cycle analyses as well as the interviews were used. The goal of the strategy is to increase the sustainability of hydrogen-powered vehicles during market entry and expansion. The advantages of the emission-free tank-to-wheel balance when using green hydrogen must be weighed against the CO<sub>2</sub> emissions of the infrastructure expansion. The critical components are the remaining CO<sub>2</sub> budget to achieve the 1.5 °C climate target and the short time period to undercut total emissions compared to maintaining conventional vehicle powertrains. To achieve the best “operating point”, a milestone to be reached is defined for each life sector.

**Table 2.** Interviewed Experts

Nr.	Expertise	Position
1	Knowledge Transfer PEM FC production	CEO
2	Business development for FCs	Consultant
3	Research on development of FC systems	R&D Manager
3	FC Research and Industry Network	Chairman
4	Integration of FCs in the power grid	Associate Prof
6	Manufacturing process for bipolar plates	Research Associate
7	Power-to-gas plants	Operations Manager
8	Networking in research projects focusing on hydrogen	CEO
9	Clean fuel and drive concepts	Project Manager
10	Recycling of platin	Project manager
11	Recycling approaches for FCs	Consultant
12	Recycling approaches for FCs	Consultant
13	Economy, energy and transport	Advisor in the German Bundestag

An iterative process would be necessary to check the progress and practicability of the sustainability strategy. In analogous sustainability strategies, the developed points are evaluated in various constellations of actors and stakeholders from politics, research, industry and citizens’ initiatives. The preparation of an independent preliminary, targeted study appears reasonable, in order to obtain a broad view of the existing conditions and possible problem areas. The regulatory, financial or idealistic obstacles should be openly discussed in order to be able to initiate improvements. In practice, it has been shown that constant evaluation and regular adaptation of a strategy are useful for achieving milestones in terms of content and in a timely manner. There is no guarantee for the success of sustainability strategies due to the complex and multi-layered nature of the topic regarding the desired change in transport and the current inertia of established structures.

Production	Hydrogen Generation	Hydrogen infrastructure	Utilization	End-of-Life
<b>Strategy Points</b>				
Investment security must be created for large-scale production of PEM FCs independent of political structures.	Coupling projects of the transport sector with the heat and energy sectors for decarbonization can enable the supply of green hydrogen.	Demand-driven hydrogen refueling infrastructure expansion can avoid emissions that would otherwise occur.	Government-owned automobile fleets, should convert to hydrogen power, reducing strain on the electric grid despite increasing e-mobility.	The creation of leasing systems for PEM fuel cells by fuel cell manufacturers and national OEMs guarantees the professional recycling of critical resources such as platinum.
<b>Milestones</b>				
Local PEM fuel cell and automotive manufacturers can act as solvent business enterprises while investing in manufacturing facilities.	Refueling of automotive fuel cell drives with hydrogen is possible, 30% of which is produced sustainably.	The supply of the existing hydrogen infrastructure is fully utilized, so that refueling stations amortize financially and in terms of emissions.	The power grid can be successfully modernized despite the increasing use of purely battery-electric private vehicles.	A standardized, exemplary leasing system for PEM fuel cells reduces the share of platinum purchases from primary sources.

**Fig. 1.** Strategy points and milestones for fuel cell vehicles

## 5 Summary

From the state of the art as well as the comparison of the life cycle analyses, hypotheses can be derived for the sustainability increase of the PEM fuel cell life cycle. Complemented by the knowledge gained from interviews with experts, the hypotheses can be used to establish 5 strategy points and milestones. These are based on production, hydrogen generation, hydrogen infrastructure, utilization, and end-of-life.

Major progress has already been made in production by fully automating the series production of a PEM FC system. A remaining challenge is the investment security, that



must be created in order to enable large-scale production of PEM FCs. For hydrogen generation, as a result of the increased use of renewable energies for power generation, the electricity peaks that occur could be used to generate green hydrogen from the electrolysis of water. In the interviews, it is regretted, that one hundred percent green hydrogen cannot be distributed at the hydrogen fuel stations due to a lack of supply. The construction of the existing hydrogen infrastructure resulted in emissions that must be deducted from the remaining CO<sub>2</sub> budget of the energy sector. When the sustainability of the PEM FC life is considered holistically, there is the potential of emission savings. The sustainability enhancement of the transport sector by 2050 is predominantly focused on the use of battery electric vehicles, although municipalities could convert their commercial vehicle fleets to PEM fuel cells in sensible business cases. The lack of a foreign purchase market requires necessary investments in local recycling structures in case of increasing return rates or creative leasing systems of the PEM fuel cells at end-of-life.

In summary, the sustainability strategy includes the promotion of knowledge transfer regarding the manufacturing processes as well as an investment security, sector coupling projects in the field of hydrogen production, an expansion stop of the refueling station infrastructure, the focus on the use in public transport and finally a leasing and tracking system of the PEM fuel cells.

## References

1. Staffell, I., Scamman, D.: The role of hydrogen and fuel cells in the global energy system. *Energy Environ. Sci.* **12**, 463–491 (2019)
2. Bothe, D., Steinfort, T.: Cradle-to-grave-lebenszyklusanalyse im mobilitätssektor. Metastudie zur CO<sub>2</sub>-Bilanz alternativer Fahrzeugantriebe. Frontier Economics Ltd. (2020)
3. Zapf, M., Pengg, H., Bütler, T., Bach, C.: Heutige und zukünftige Treibhausgasemissionen nach einer Life-Cycle-Analysis (LCA). In: Zapf, M., Pengg, H., et al. (eds.) *Kosteneffiziente und nachhaltige Automobile*. 1. Auflage, pp. 119–177. Springer Fachmedien Wiesbaden (2019)
4. Simons, A., Bauer, C.: A life-cycle perspective on automotive FCs. *Appl. Energy* **157**, 884–896 (2015)
5. Miotti, M., Hofer, J., et al.: Integrated environmental and economic assessment of current and future FC vehicles. *Int. J. Life Cycle Anal.* **22**(1), 94–110 (2018)
6. Li, M., Zhang, X., Li, G.: A comparative assessment of battery and FC electric vehicles using a well-to-wheel analysis. *Energy* **94**, 693–704 (2016)
7. Ahmadi, P., Kjeang, E.: Realistic simulation of fuel economy and life cycle metrics for hydrogen FC vehicles. *Int. J. Energy Res.* **41**(5), 714–727 (2017)
8. Prevedouros, P., Mitropoulos, L.: Life cycle emissions and cost study of light duty vehicles. *Transp. Res. Procedia* **15**, 749–760 (2016)
9. Evangelisti, S., Tagliaferri, C., et al.: Life cycle analysis of a polymer electrolyte membrane FC system for passenger vehicles. *J. Clean. Prod.* **142**, 4339–4355 (2017)
10. Meyer, K., Helms, H., et al.: *Klimabilanz von strombasierten Antrieben und Kraftstoffen*. Institut für Energie- und Umweltforschung Heidelberg GmbH (2019)
11. Karaaslan, E., Zhao, Y., Tatar, O.: Comparative life cycle analysis of sport utility vehicles with different fuel options. *Int. J. Life Cycle Anal.* **23**, 333–347 (2018)
12. Sternberg, A., Hank, C., Hebling, C.: *Treibhausgas-Emissionen für Batterie- und Brennstoffzellenfahrzeuge mit Reichweiten über 300 km: Studie im Auftrag der H2 Mobility. Studie im Auftrag der H2 Mobility* (2019)

13. Bekel, K., Pauliuk, S.: Prospective cost and environmental impact assessment of battery and FC electric vehicles in Germany. *Int. J. Life Cycle Anal.* **24**(12), 2220–2237 (2019)
14. Cox, B., Bauer, C., Beltran, A., van Vuuren, D., Mutel, C.: Life cycle environmental and cost comparison of current and future passenger cars under different energy scenarios. *Appl. Energy* **269**, 115021–112033 (2020)
15. Lozanovski, A., Dingel, O., et al.: Technische und ökobilanzielle Analyse von Langstrecken-Lastkraftwagen für das Jahr 2050. Universität Stuttgart, IAV GmbH, Forschungsvereinigung Verbrennungskraftmaschinen e.V (2020)

**Open Access** This chapter is licensed under the terms of the Creative Commons Attribution 4.0 International License (<http://creativecommons.org/licenses/by/4.0/>), which permits use, sharing, adaptation, distribution and reproduction in any medium or format, as long as you give appropriate credit to the original author(s) and the source, provide a link to the Creative Commons license and indicate if changes were made.

The images or other third party material in this chapter are included in the chapter's Creative Commons license, unless indicated otherwise in a credit line to the material. If material is not included in the chapter's Creative Commons license and your intended use is not permitted by statutory regulation or exceeds the permitted use, you will need to obtain permission directly from the copyright holder.





# A New Business Model for the Circular Economy of Electric Vehicles

Parnia Shafinejad<sup>1</sup> (✉), Konstantinos Georgopoulos<sup>2</sup>, Michael Bolech<sup>2</sup>,  
and Giacomo Copani<sup>1</sup>

<sup>1</sup> National Research Council of Italy the Institute of Intelligent Industrial Technologies and Systems for Advanced Manufacturing, STIIMA-CNR), Via Alfonso Corti 12, 20133 Milan, Italy  
Parnia.shafinejad@stiima.cnr.it

<sup>2</sup> Circular Economy Solutions GmbH, Greschbachstr. 3, 76229 Karlsruhe, Germany

**Abstract.** The market for electrical vehicles (EVs) is expected to show constant growth in the next years. However, Europe is not prepared to manage such a massive flow of electric vehicles at the End-of-Life (EoL). Consolidated value chains including recyclers, remanufacturers, and dismantlers able to treat key parts of EVs efficiently and safely at the EoL (such as batteries) do not exist at the needed industrial scale due to their novelty and complexity which requires innovative technologies and methods.

Furthermore, the huge uncertainty on the volume of parts, their EoL conditions, materials cost fluctuations, and market acceptability discourage companies from starting new recycling/remanufacturing businesses. This carries the risk of delaying the consolidation of European value chains specialized in the EoL management of EVs. In order to address these challenges, the present research, which was carried out in the frame of the H2020 “CarE-Service” European-funded project, proposes a new circular business model for the EoL management of EVs.

**Keywords:** Circular Economy · Automotive Supply Chain · End-of-Life vehicles management

## 1 Introduction

With growing awareness of climate change, the transportation sector is one of the main areas for carbon reduction strategies [1]. The advantages of lithium-ion batteries (LIBs) as the power component for EVs as well as the higher efficiency of EVs compared to internal combustion engines are creating a revolution across the sector. During the last decade, EV production has drastically increased from a few thousand to 11.3 million EVs in 2020 [2]. In order to meet existing government policies, more than 142 million EVs will be on the road in 2030 and this could increase even more.

The electrification trend goes in the direction of sustainability because it reduces the recourse to fossil fuel, and it raises also challenges associated with EVs manufacturing and EoL supply chains [3, 4]. Large quantities of critical raw materials (Fe, Al, Co, Ni, Li, etc.) will be necessary to produce batteries and other added-value components

of EVs, with the consequent need for intensive mining processes [5]. Thus, reusing and recycling strategies for EVs should be systematically pursued. However, proper collection and transportation of end-of-life vehicles (ELVs) [6], secure battery removal from vehicles, and efficient disassembly processes of valuable parts require specific knowledge, trained personnel, and special tools and equipment to guarantee safe EoL treatment processes that also do not damage the environment [7–9]

Circular economy (CE) aims to maintain the value of products, components and parts through reuse, repair, remanufacturing, upgrade, and recycling approaches [10]. We are in a transition period in which the number of EVs reaching their EoL increases while Europe is not prepared to manage them properly [10, 11, 13]. Due to the current low number of EVs at EoL, the availability of spare parts from EVs is insufficient. Therefore, the market for reuse and remanufactured parts from EVs is limited and uncertain and reverse supply companies are discouraged from investing and offering EoL parts services [13, 14]. Besides, there is still a lack of consolidated, high-scale reuse and recycling value chains specialized in the EoL treatment of EVs.

To address the aforementioned challenges, this paper proposes a new circular economy business model for the EoL management of EVs. The new business model is based on innovative dismantling technologies and an Information and Communications Technology (ICT) Platform for efficient integration and coordination of all stakeholders of the circular EVs value chain as well as for the establishment of a trusted marketplace of remanufactured parts and recycled materials.

## 2 State of the Art

Every year, millions of vehicles in Europe reach the end of their life. The EU Directive 2000/53/EC imposes obligations to increase the recovery of all ELVs in order to recycle and reuse parts and materials accounting for 95% of an average vehicle weight [8]. Since a vehicle is a complex product composed of thousands of parts with different materials, ELV recovery is a complicated process [9]. The establishment of a circular economy approach is of paramount importance to guarantee future sustainability in the automotive industry and exploit the economic potential offered by reusing various parts and components the way they are disassembled from an EV for spare market; remanufacturing by repairing and replacing some components from disassembled parts to make them usable in the same or different application and recycling of high-value components of post-use EVs to extract the raw materials from parts that are known as waste or are not reusable or manufacturable [10]. However, due to the novelty of EVs, such an approach is not fully employed [14]. Our investigation on existing scientific literature shows that there is still a lack of circular business models for ELVs management at the supply chain level and issues such as reverse logistics [3, 9, 15], optimization models for closed-loop supply chain [7, 16], recovery infrastructure and disassembly [8] are at the center of studies.

Several high-added-value components are not systematically recovered and they are part of the undifferentiated flow of automotive waste that is recycled through shredding and chemical processes after the removal of hazardous materials [17]. In terms of materials, it can be estimated that ferrous and non-ferrous metal parts represent 60% to

70% of the overall materials. At the moment, after removing reusable and recyclable vehicle parts, the hulk is compressed and transferred to a shredder, whose task is mainly to recover metals [18]. The content of techno-polymers (advanced polymers with high mechanical properties that substitute metals to reduce vehicle weight) in EVs is higher than in traditional combustion vehicles and it is expected to increase significantly in the next years [9]. The automotive post-use techno-polymers are not currently recovered and recycled. Thus, there is a high potential to improve sustainability by introducing circular strategies for metal and techno-polymer materials such as re-manufacturing or recycling. In addition, with the introduction of EVs, batteries pose severe challenges to dismantling as operations are mainly manual and dangerous [3, 17, 19]. Furthermore, there is a lack of sufficient information about the performance of retired batteries and the lack of new market opportunities for second-use applications [10, 16].

Besides single solutions to address various materials and parts, proposals of systemic supply chain approaches are missing. The automotive supply chain actors act in a fragmented way which slows down the establishment of consolidated circular chains [14].

### 3 Methodology

This article presents the results of the “CarE-Service” project, a European H2020-funded project aimed at establishing new technologies and business models for the circular economy of EVs (Grant Agreement number 776851). Several supply chain stakeholders such as automotive OEMs, recyclers, remanufacturers, dismantlers, technology providers, and ICT Platform developers were involved to design a new circular business model for the EoL of EVs, to provide requirements for the dismantling of critical EVs parts (e.g. Batteries), as well as to test new technologies and support economic simulations for sustainability assessment [20].

8 in-depth interviews with stakeholders at different levels of the supply chain and two workshops were carried out to collaboratively define the pillar of the future circular business models and the specifications of the ICT Platform that will support it.

The stakeholder network diagram was used, as an instrument to help practitioners identify partners and define To-Be network relationships (Fig. 1). The business model canvas was used as a framework to design the new business model [21]. Finally, the ICT Platform was developed according to the Agile framework (Scrum) methodology. During each “sprint”, incremental developments were tested and validated by stakeholders engaged in the project.

After the development of the business model, ICT Platform, and advanced dismantling solutions an integrated economic assessment was carried out using Discounted Cash Flow techniques (DCF), considering an assessment period of 10 years and calculating indicators such as the Net Present Value (NPV) and the Pay Back Time (PBT).

## 4 Results

### 4.1 The Smart Movable Modules (SMMs)

EVs are “new products” for dismantlers and require new skills and disassembly technologies/processes that are too sophisticated and/or expensive to be acquired in a short time,



## 4.2 A New Integrated CarE-Service ICT Platform for the EOL Management of EVs

A new ecosystem, the CarE-Service Community, has been created through the CarE-Service ICT Platform. It is built on the business relationship among different stakeholders, from different industries and trade levels (Fig. 2). All the members of the CarE-Service Community can benefit from the services offered, such as the marketplace, the SMMs, and the logistic services.

Based on the value proposition of the business model, for all the targeted customer segments the platform offers a demand-driven trading marketplace of high-added-value parts and components from EVs. It also gives access to the dismantling and testing services (via SMMs that are booked through the Platform) and to logistic services such as transport of the purchased parts. The main advantage is the combined use of the SMMs and the marketplace, as this makes the platform stronger and more competitive in the market against other existing marketplaces, as the standardized dismantling and testing processes ensure the quality of the traded parts. In addition, users can receive support and services for the dismantling and upcycling of EVs parts and request that new products are added to the marketplace.



**Fig. 2.** CarE-Service community systemic view

A client application was created for the operators of the disassembly SMM, with a double purpose: First to keep the data of the dismantling process updated on the marketplace with a direct link from the operational field to the Platform. Second, for connecting to a knowledge database where all the information about performed processes to implement a sort of machine learning approaches are stored. In this way, the SMM operators can be guided in the disassembly of various types of batteries.

Another client application was developed to enable two-way information exchange between the Platform and the testing process carried out in the testing SMM. The application is based on a guided process for the selection and inspection of cores (used

automotive parts) under the name “CoremanNet”<sup>1</sup>, which was expanded for the selection of batteries, metal parts and techno-polymers coming from EoL EVs. The selection process is a guided process and proceeds according to criteria that the operator selects from predefined values on a list. At the end of the selection, all the information provided by the operator is posted on the marketplace as the characteristics of the part, while the part is already assigned to its owner (seller on the marketplace).

The logistics feature provides shipment management to the marketplace and it is based on the “Circul8”<sup>2</sup> Platform. Companies need to be approved by the Platform before they can act as an official logistics provider for the marketplace. Through decision matrixes, the logistics feature determines the optimal route and price for the marketplace order based on a set of criteria, like the container type, regions of buyer and seller, or weight. Logistic providers can access logistics features such as downloading reports, managing orders or placing custom quotations.

The “drop-off locations” feature allows external stakeholders (car dealers, workshops, municipalities, or even car owners) to find local dismantlers who are community members. This feature fulfills the gap between the marketplace and the market of the EoL EVs and feeds the marketplace with parts.

### 4.3 Impact and Sustainability of the CarE-Service ICT Platform

The result of the economic simulation depends on the technical evolution in battery remanufacturing and recycling, metal remanufacturing, and techno-polymers recycling value chains developed through the project. The technical solutions from three value chains of battery, metal and techno-polymers at ELVs quantified the capacity of producing remanufactured and recycled parts. Using the forecasted number of EoL EVs over the next 10 years led us to evaluate the economic sustainability of such a consolidated community described in Sect. 4.2. Hypothetically only 3–5% of such a market is considered to be treated via the CarE-Service network.

To evaluate such sustainability, DCF and NPV analysis for 10 years of business operation is adopted from years 1 to 10 (Formula 1), where CF stands for cumulated Cash Flow and is divided by the interest rate ( $r$ ) per number of years:

$$DCF = CF_1/(1+r)^1 + CF_2/(1+r)^2 + \dots + CF_n/(1+r)^n \quad (1)$$

Several key variables to quantify costs and revenues are linked to this formula. Costs are mainly the operation and development costs of such a platform while revenues are generated mainly from fees per sold remanufactured/recycled parts plus the percentual share of SMM services. Since the availability of EoL EVs at the moment is limited, it is assumed that the CarE-Service ICT Platform market segment will mainly support groups of Small to Medium Sized Enterprises (SMEs) of remanufacturers, recyclers and service providers. Therefore, the number of stakeholders (dismantlers, remanufacturers, recyclers and service providers) that trade various parts inside the platform are cumulated for each year as key variables to multiply into the single cost-revenue block.

<sup>1</sup> Coremannet, Circular Economy Solutions GmbH, [Online]. Available: <https://www.coremannet.com/home/>.

<sup>2</sup> L. Software, “Landbell Software,” [Online]. Available: <https://landbell-software.com/>.



The CarE-Service ICT platform will have a forecasted turnover ranging from 1 million Euro (M€) to 10 M€ from year 1 to year 10 respectively with an overall NPV of 13 M€. In this simulation, the number of stakeholders in the considered evaluation period ranges from 60 to more than 600 in year 10. Following the same methodology and according to key variables such as the number of customers (mainly small to medium-sized dismantlers who can hardly afford the high investment costs of dismantling machinery), volumes of disassembled batteries over 10 years considering the incremental rate of batteries at EoL; the price per disassembly and testing services by SMMs company, the business for the SMMs is found to be sustainable with an NPV of 5 M€ over 10 years. In this simulation, the number of operating SMM will range from 28 SMMs and 27 SMM in year 1, up to 124 SMM in year 10 which will allow meeting the demand of the increasing EoL EVs.

## 5 Conclusion

In the automotive sector, new business opportunities can be exploited and considerable environmental savings can be achieved by adopting circular economy strategies for EVs. At the moment, there is a lack of a consolidated supply chain to help this transition toward the circular economy and stakeholders in the supply chain act in a fragmented way. This paper proposed a new business model supported by advanced disassembling technologies and a cloud-based platform that coordinates the EoL supply chain actors.

The CarE-Service Platform provides a marketplace with virtual stores, where the car parts can be placed to be sold to any other member of the community. The ICT Platform, at its core, also acts as a demand-driven platform where any player can request specific products. Finally, the SMMs integrated with the CarE-Service platform allow the community to seamlessly dismantle car parts based on industry best practices and add value to these parts by testing, certifying them, and proposing the best possible purpose. What makes the CarE-Service Platform business models unique are B2B Platform specialized in the circular economy of EVs; Integration and orchestration of all the stakeholders of the new EV reverse chains; Offering dismantling and testing services on-demand through an integrated business model with SMMs; Unbiased testing and certified parts to reduce uncertainties of the circular business.

**Acknowledgments.** This paper was realized as part of the “CarE-Service” project that has received funding from the European Union’s Horizon 2020 research and innovation program under grant agreement No. 776851. Special thanks to the project consortium partners from CIA Robotics Srl, IMA Dresden GmbH, and Landbell Software SA for their effort, support, and technical knowledge throughout the project to develop these solutions.

## References

1. Mendizabal, M., et al.: Triggers of change to achieve sustainable, resilient, and adaptive cities. *City Environ. Interact* **12**, 100071 (2021)

2. IEA: Global EV outlook, April 2021. [Online]. <https://www.iea.org/reports/global-ev-outlook-2021>
3. Rajaeifar, M.A., Ghadimi, P., Raugei, M., Wud, Y., Heidrich, O.: Challenges and recent developments in supply and value chains of electric vehicle batteries: a sustainability perspective. *Resour. Conserv. Recycl.* **180**, 106144 (2022)
4. Rohit, A., Anil, K., Vishal. Ashok, W., Sunil, L.: Analysing the Roadblocks of Circular Economy Adoption in the Automobile Sector: Reducing Waste and Environmental Perspectives, vol. 30, p. 1051, ERP Environment and John Wiley & Sons Ltd. (2020)
5. Rajaeifar, M.A., Heidrich, O., Ghadimi, P., Raugei, M., Wu, Y.: Sustainable supply and value chains of electric vehicle batteries. *Resour. Conserv. Recycl.* **161**, 104905 (2020)
6. Mohan, T.V.K., Amit, R.K.: Dismantlers' dilemma in end-of-life vehicle recycling markets: a system dynamics model. *Ann. Oper. Res.* **290**(1–2), 591–619 (2018). <https://doi.org/10.1007/s10479-018-2930-z>
7. Rashid, F.A.A., Hishamuddin, H., Mansor, M.R.A., Saibani, N.: Supply chain optimization for end-of-life vehicle recycling: a preliminary review. In: Proceedings of the 11th Annual International Conference on Industrial Engineering and Operations Management, Singapore (2021)
8. Karagoz, S., Aydin, N., Simic, V.: End of life vehicle management: a comprehensive review. *J. Mater. Cycles Waste Manage.* **22**, 416–442 (2020)
9. Zarei, M., Mansour, S., Kashan, A.H., Karimi, B.: Designing a reverse logistics network for end-of-life vehicles recovery. *Math. Probl. Eng.* **2010** (2010)
10. Alamerew, Y.A., Brissaud, D.: Modelling reverse supply chain through system dynamics for realizing the transition towards the circular economy: a case study on electric vehicle batteries. *J. Clean. Prod.* **254**, 120025 (2020)
11. "Statista," European Commission, November 2018. [Online]. <https://www.statista.com/statistics/1012083/ev-batteries-expected-end-of-life-stock-eu/>
12. Abdelbaky, M., Peeters, J.R., Duflou, J.R., Dewulf, W.: Forecasting the EU recycling potential for batteries from electric vehicles. *Procedia CIRP* **90**, 432–436 (2020)
13. Hua, Y., et al.: Sustainable value chain of retired lithium-ion batteries for electric vehicles. *J. Power Sources* **478** (2020)
14. Casper, R., Sundin, E.: Electrification in the automotive industry: effects in remanufacturing. *J. Remanufact.* **11**(2), 121–136 (2020). <https://doi.org/10.1007/s13243-020-00094-8>
15. Zhang, X., Zou, B., Feng, Z., Wang, Y., Yan, W.: A Review on remanufacturing reverse logistics network design and model optimization. *Processes* **10** (2022)
16. Li, L., Dababneh, F., Zhao, J.: Cost-effective supply chain for electric vehicle battery remanufacturing. *Appl. Energy* **226**, 277–286 (2018)
17. Merkisz-Guranowska, A.: A comparative study on end-of-life vehicles network design. *Arch. Transp.* **54**(2), 107–123 (2020)
18. Qiao, Q., Zhao, F., Liua, Z., Hao, H.: Electric vehicle recycling in China: economic and environmental benefits. *Resour. Conserv. Recycl.* **140**, 45–53 (2019)
19. Steward, D., Mayyas, A., Mann, M.: Economics and challenges of Li-Ion battery recycling from end-of-life vehicles. In: 16th Global Conference on Sustainable Manufacturing - Sustainable Manufacturing for Global Circular Economy (2019)
20. Bilgeri, D., Brandt, V., Lang, M., Tesch, J., Weinberger, M.: The IoT business model build. A White Paper of the Bosch IoT Lab in collaboration with Bosch Software Innovations GmbH (2015)
21. Osterwalder, A., Pigneur, Y., Hazen, B., Smith, A.: Business Model Generation: A Guide for Visionaries, Game Changers, and Challengers, Campus Publisher (2011)

**Open Access** This chapter is licensed under the terms of the Creative Commons Attribution 4.0 International License (<http://creativecommons.org/licenses/by/4.0/>), which permits use, sharing, adaptation, distribution and reproduction in any medium or format, as long as you give appropriate credit to the original author(s) and the source, provide a link to the Creative Commons license and indicate if changes were made.

The images or other third party material in this chapter are included in the chapter's Creative Commons license, unless indicated otherwise in a credit line to the material. If material is not included in the chapter's Creative Commons license and your intended use is not permitted by statutory regulation or exceeds the permitted use, you will need to obtain permission directly from the copyright holder.





# Design Model for the Sustainability Management of Manufacturing Companies

Felix Sohnius<sup>(✉)</sup>, Martin Iglauer, and Robert H. Schmitt

Laboratory for Machine Tools and Production Engineering WZL of RWTH, Aachen University,  
Campus-Boulevard 30, 52074 Aachen, Germany  
f.sohnius@wzl-mq.rwth-aachen.de

**Abstract.** This paper presents a design model that supports the systematic steering and operationalization of sustainability in manufacturing industry at all corporate levels. Studies show (e.g. Ramboll Group, Smurfit Kappa) that companies are aware of both the need for and the opportunities of corporate sustainability. Corporate sustainability means improving environmental and social effects as well as conditions, while operating profitably in the long term. However, companies face the challenge of resolving the complexity of corporate sustainability. Due to this challenge, the sustainability management model presented in this paper provides a holistic framework that addresses the relevant elements, fields of action and interrelationships of sustainability management in manufacturing companies. A top-down approach enables the management of sustainability at several corporate levels. In addition, various design elements enable the integration of sub-models through which a further concretization and operationalization of corporate sustainability can be realized.

**Keywords:** Sustainability Management · Sustainable Production

## 1 Introduction

Responsible and far-sighted behavior is more important than ever for the continuation of a livable world and a healthy society considering today's global developments and the effects of human actions (e.g. climate change, pandemics, resource scarcity and inequality). In this respect, sustainability provides the guiding principle for a conscious and life-saving use of ecological, social, and economic resources [1]. The strategic direction and operational actions of a manufacturing company determine whether it makes a positive or negative contribution to sustainable development [2].

In this context companies are faced with the challenge of resolving the complexity of corporate sustainability through systematic steering as part of sustainability management. The complexity is particularly formed by the interwoven relationships of sustainability over the entire product life cycle, the requirements of all stakeholders and the uncertainty of the effects of sustainability-driven decisions. To address this complexity, a systematic business orientation and an effective operationalization is crucial. A company's resources, goals and opportunities must be brought together across divisions

at the normative, strategic, and operational level. For sustainability management, it is important not to create isolated solutions, but to establish an overall corporate solution. In this respect, a holistic sustainability management model is required that supports the management of sustainability at all corporate levels [3, 4].

Based on the previously described challenges, the following research question is derived: “Can the complexity of corporate sustainability be addressed and solved by a holistic management model?” In this paper, such a sustainability management model is introduced. Section 2 initially presents the key requirements for sustainability management in manufacturing companies as well as existing approaches that have been evaluated based on these requirements. Section 3 covers the principles and methods used to develop the model, while Sect. 4 introduces the design model. Section 5 discusses the evaluation of the model before concluding the paper with a summary and outlook in Sect. 6.

## 2 State of the Art

This chapter focuses on the review of existing frameworks in sustainability management. In view of the challenges and problems described at the beginning of this article, four scientific publications will first be presented and evaluated.

### **Busch et al. – Framework for Shaping Sustainability in Manufacturing Companies:**

The framework establishes a connection between sustainability aspects and the product life cycle via nine fields of action. In addition, three overarching sustainability goals are defined for the phases of the product life cycle. With a requirement-specific character, fields of action are described predominantly at the strategic level, which can lead to an increase in corporate sustainability. These also include the perspective on the use and management of data. However, essential aspects of sustainability management such as the corporate mission statement, circular economy, stakeholders, operationalization of sustainability or internal and external communication remain unaddressed [5].

**Briele et al. – Internet of Sustainability (IoS):** The Internet of Sustainability (IoS) model is an extension of the existing data-driven framework Internet of Production (IoP) [6]. The model consists of three data layers (Raw Data Layer, Smart Data Layer and Smart Expert Layer) that enable data aggregation from raw data to information mining in the economic, environmental, and social sustainability dimensions. In addition, the model connects the data layers across the entire product lifecycle in terms of the circular economy. The IoS model represents a promising approach to data management in sustainability management and structuring along the circular economy, but it only refers to data aspects. With a view to a holistic management model, this aspect must be brought into line with other aspects of sustainability management [7].

### **Panagiotakopoulos et al. – Viable System Model in Sustainability Management:**

The research links corporate sustainability to the Viable System Model (VSM). Specifically, a model is proposed that enables the stepwise integration of sustainability aspects via the basic structure of the VSM. The VSM describes the interrelationships of the three main elements management, operations, and environment. This basic structure enables

the integration of sustainability aspects in an organization via three analysis steps respectively three different layers (Business Management Layer, Sustainability Management Layer and Sustainability Issue Layer). This approach helps to break down superordinate tasks at the normative and strategic level into specific subtasks at the operational level. However, due to an increasing number of models at the issue level, there is a risk of increasing complexity. Furthermore, some required and already mentioned aspects (in section Busch et al.) are not considered [8].

**Lozano – Framework of Organizational Sustainability:** The input-output model relates elements of corporate sustainability to one another. The model can be described in terms of five categories: inputs (e.g., material, human resources), system elements (e.g., management, organizational systems, governance), internal and external stakeholders, outputs (e.g., products and services), and resource efficiency & effectiveness. The model represents an organizational framework that enables a holistic view of companies to locate fields of action of corporate sustainability on the normative and strategic management level. However, the entire level of operational management is not mapped, nor is the principle of circular economy [9].

This brief overview shows that none of the approaches offers a detailed product lifecycle-oriented sustainability management model that identifies the most important corporate components as well as their fields of action, synergies, and conflicting goals. Furthermore, there is a deficit in the transfer of normative and strategic into operational aspects and thus in the operationalization of sustainability through quantitative and qualitative methods, instruments, and key figures. To satisfy this need for research, the model development not only relies on the positive aspects of the scientific publications, but also on the contents of existing and established approaches. These include ISO standards (e.g. ISO 14001, 26000, etc.), management models (e.g. St. Gallen Management Model, Aachen Quality Management Model, etc.) and reporting standards (e.g. Global Reporting Initiative, etc.).

### 3 Methodology for the Creation of the Design Model

In this paper, the approach according to BÖHM ET AL. is used for model building. This process consists of two successive abstraction stages. In the first abstraction step, a thought model of the real system is created and sketched. In a further abstraction step, this thought model is represented in a more detailed and tangible form with the help of language, figures, pictures, graphics, numbers, etc. [10] In addition, the concept Architecture of Integrated Information Systems (ARIS) according to SCHEER and the interpretation in the context of engineering modeling according to DE LANGE is used. With the help of the model theory and the five views of ARIS, the scientifically based structuring of the design model and the holistic derivation of individual design elements is ensured. The concept provides a simple and at the same time holistic structuring via the following five different views: [11, 12].

- **Organizational view:** Mapping of the organizational structure and units involved.

- **Functional view:** Operations or activities that transform inputs into outputs. Since certain goals are pursued via functions, they are also part of the function view.
- **Performance view:** Input and output performances processed in the function view. They are the yardstick for the fulfillment of the functions.
- **Data view:** Mapping of all relevant data such as environment data, input and output information, and their interrelationships.
- **Steering view:** Defining relations between all views and enabling a holistic context

The ARIS concept is moreover utilized in the following chapter to present individual design elements of the model in a structured manner.

## 4 Design Model for the Sustainability Management of Manufacturing Companies

At the beginning of this chapter, the overall design model is introduced in Fig. 1. It presents the relevant elements, fields of action and interrelationships of sustainability management in manufacturing companies in a holistic manner. Subsequently, the individual design elements of the model are presented following the ARIS logic.

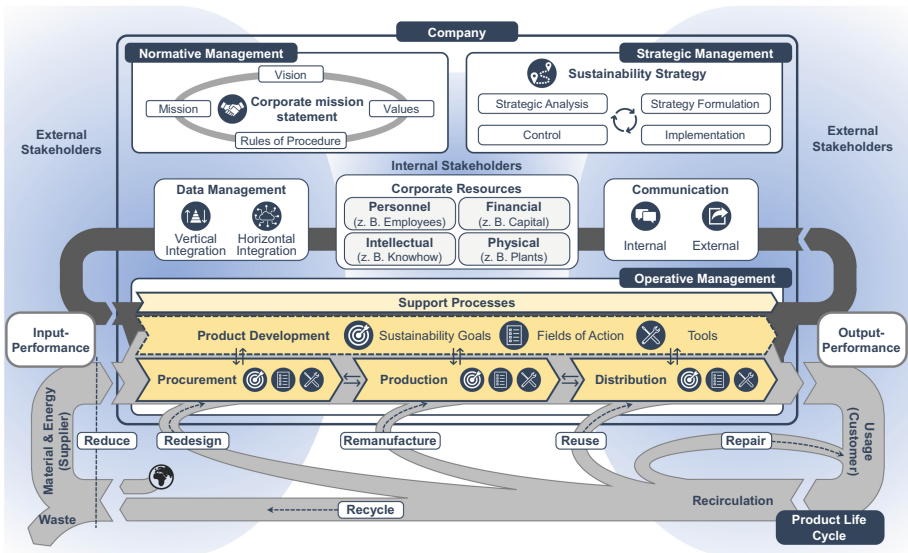


Fig. 1. Corporate sustainability management model

*Design Elements of the Organizational View.* The design elements of the organizational view represent the basis and thus the regulatory framework of the design model. In this context, the steering of a company is basically to be carried out via the design elements *normative, strategic, and operative management*. In operative management,

the core processes – *product development, procurement, production, and distribution*, as well as *support processes* – are primarily addressed. These processes are not only decisive for the value creation of a company, but also have significant influence on corporate sustainability. *Product development*, often classified as a support process in the literature, is however mapped as a core process in the sustainability management model, as it has a significant influence on many sustainability aspects of a product and many dependencies on the aforementioned processes. Besides the company's internal design elements, the entire product life cycle must be considered in the sense of the circular economy. To this end, the design elements of *material & energy, usage and recirculation* are integrated into the design model. As a further design element of the organizational view, both *internal stakeholders* and *external stakeholders* who place requirements on the company are integrated. These are to be seen as the central element against which corporate sustainability is aligned and sustainability performance is measured.

*Design Elements of the Functional View.* The requirements of the stakeholders are processed in normative and strategic management via their design elements of the functional view. In normative management the *corporate mission statement* must be established. Building on this, the *sustainability strategy* is to be developed in strategic management. These two design elements set the guard rails for operational management. The operative management serves to operationalize sustainability. For this purpose, three design elements are deduced from the functional perspective. *Operational sustainability goals* are to be derived from the strategic goals. In this context, key figures must be developed. The purpose of key figures in general is to create transparency, but above all, to make decisions more objective by presenting complex issues in a way that is easy to understand, enabling the formulation of goals and strategies, and facilitating goal-oriented corporate management. This applies not only to general corporate issues, but also to the complex topic of sustainability. The goals must be addressed in operational management to managers and experts in the respective organizational areas and must be compared with existing goals to identify conflicts or synergies. *Fields of action* are to be identified to pursue the defined sustainability goals. The fields of action are to be integrated into existing operational processes or extend them. Similar to the sustainability goals, conflicts with existing fields of action must be avoided and synergies created. *Tools*, as the third design element in operative management, serve to further operationalize sustainability, i.e., to concretize, measure and practically implement the corporate mission statement and the sustainability strategy. The operationalization is to be managed by quantitative and qualitative methods as well as key figures.

*Design Elements of the Performance View.* Sustainability performance is to be understood as both the input and output performance of a company. Input and output variables, as well as transformation processes, are to be planned and evaluated according to economic, ecological, and social aspects. The sustainability performance relates to the *company resources* (e.g. human, financial, intellectual and physical), to the upstream product life cycle phase *material & energy* as well as to the products and services provided on the market in the *usage* phase. The design elements of the functional view define target values for the strived sustainability performance as well as procedures and tools for achieving these.



*Design Elements of the Data View.* *Data management* as a design element of the data view serves to provide data to optimally support the processes of sustainability management. The approach of BRIELE ET AL. addresses the use and integration of sustainability data to incorporate them into decision-making processes. In the design model, a distinction is made between *vertical data integration* (including data collection, availability, storage, and provision) and *horizontal data integration* (data networking within and outside the company). Against this background and the topic of data analytics, SCHMITT ET AL. understand sustainability analytics as a key element for achieving the goal of vertical and horizontal data integration. This includes data-driven methods and tools that transform raw data into information and knowledge on sustainability topics [13].

*Design Elements of the Steering View.* The design elements of the steering view address the linking of the individual organizational areas of a company. *Interface management* is viewed on the one hand between normative, strategic, and operational management. On the other hand, interface functions describe tasks and challenges that are to be solved through interaction between individual internal and external organizational areas as well as stakeholders. In this context, interfaces are to be understood as organizational points at which information, goods or financial resources are exchanged. The main challenges are the identification and optimization of interface functions as well as the systematic coordination of the cooperation between the business units. *Communication* is another design element of the steering view. Internal communication, especially to raise awareness of vulnerability within the company, as well as external communication to create transparency, credibility and a good reputation must be addressed. Furthermore, *recirculations in the product life cycle* are to be considered as design elements of steering view. These are aligned with the 6R's of sustainability methodology. Each organizational area is supposed to reflect the 6R's in the design of its goals and tasks, and thus develop solutions for sustaining the circular economy. The element *Repair* serves to maintain a product in its usage phase and extend this via service, maintenance, and repair concepts. *Reuse* involves returning used functional products back to the market through a company's distribution channels. *Remanufacturing* involves refurbishing used defective products or components into as-new form and returning them to the market directly or as part of new products. *Redesign* is particularly aimed at sustainable product design for future product generations. However, redesign also concerns the sustainable redesign of processes, resource use and partnerships. *Recycling* enables the conversion of materials assigned to waste into new raw materials. *Reduce* aims at trimming down material and energy consumption to decrease the amount of natural and harmful resources as well as waste in the circular economy [14].

## 5 Evaluation

In evaluating the design model, the expert interview method was used. Three experts – a managing director operations, a quality manager, and a production manager – from a globally operating and producing company group in the mechanical and plant engineering sector were selected to evaluate the model.

The first evaluation section assessed the relevance of corporate sustainability and the understanding of its complexity. To sum up, they confirm the challenges that were already made clear in the introduction. In detail, the experts see the challenge in the sustainable transformation of the corporate structures via existing processes and structures, the management of sustainability via suitable processes, the definition and use of sustainability indicators, the inclusion of the entire value chain and product life cycle and the raising of awareness in the global workforce.

In a second evaluation section, the model was assessed quantitatively and qualitatively regarding solving these challenges. The quantitative evaluation is carried out using a ten-point scale for the five factors *understandability*, *accuracy*, *completeness*, *applicability*, and *usefulness*. The rating is mostly between 8 and 9, in rare cases 10 or 7. The qualitative evaluation of the factors also shows a good rating. In short, the experts assess the design model as a holistic management model that maps the relevant elements and interrelationships, enables the step-by-step and area-by-area integration of sustainability aspects, and can be harmonized with existing structures. As optimization possibilities, the concretization of sub-models and the elaboration of a procedure for transferring the abstract model into concrete processes are mentioned.

## 6 Conclusion and Outlook

This paper presents a design model for managing the sustainability of manufacturing companies. A literature review identifies the key requirements for the sustainability management and confirms the need for a management model to address and resolve the complexity of corporate sustainability. A two-step process of model building was applied, which additionally considers the concept of Architecture of Integrated Information Systems (ARIS). Design elements of the organizational, functional, performance, data, and steering view are developed as well as summarized and structured in a design model. This model holistically maps the relevant elements, fields of action and interrelationships of sustainability management in manufacturing companies. Moreover, it enables the integration of sub-models for further concretizing or operationalizing corporate sustainability. An initial practical and application-oriented model evaluation by experts from a globally operating and manufacturing company provides indications that the model is well suited for the integration of sustainability aspects and the establishment of a sustainability management system. In summary, the design model thus contributes to answering the research question by enabling the management of corporate sustainability via a top-down approach.

However, in future research, the model must be further developed. The design elements such as product development or production must be concretized by sub-models, which in turn can be integrated into the design model. In this context, practice-oriented solutions are to be elaborated that flesh out selected design elements in detail. In this way, the design model could be completed step by step. For the application of the model in practice, a procedure or a guideline must be developed. There is a further need for research in the validation of the design model. For this purpose, the application of the model through case studies in manufacturing companies is suitable. In these case studies, the design model could be applied as an aid for a gap analysis for the topic of corporate sustainability.

## References

1. Hauff, M.: Nachhaltige Entwicklung. 3rd edn. De Gruyter Oldenbourg, Berlin (2021)
2. Fischer, K.: Corporate Sustainability Governance. 1st edn. Springer, Wiesbaden (2017)
3. Abraham, V., et al.: Managing Sustainability, Ramboll Deutschland GmbH (2019)
4. Kappa, S.: Nachhaltigkeit verändert die Geschäftswelt für immer (2020)
5. Busch, M., et al.: Sustainable Production Ordnungsrahmen zur Gestaltung von Nachhaltigkeit in produzierenden Unternehmen. Zeitschrift für wirtschaftlichen Fabrikbetrieb, **116**(4), 203–207 (2021)
6. Schmitt, R.H., et al.: Datenbasiertes Qualitätsmanagement im Internet of Production. In: Frenz, W. (ed.) Handbuch Industrie 4.0: Recht, Technik, Gesellschaft, pp. 489–516. Springer, Heidelberg (2020). [https://doi.org/10.1007/978-3-662-58474-3\\_25](https://doi.org/10.1007/978-3-662-58474-3_25)
7. Briele, K., et al.: Internet of sustainability – data-driven sustainability management in production. In: Behrens, B.-A., Brosius, A., Drossel, W.-G., Hintze, W., Ihlenfeldt, S., Nyhuis, P. (eds.) WGP 2021. LNPE, pp. 639–647. Springer, Cham (2022). [https://doi.org/10.1007/978-3-030-78424-9\\_70](https://doi.org/10.1007/978-3-030-78424-9_70)
8. Panagiotakopoulos, P D., et al.: Sustainability management: insights from the Viable System Model. J. Clean. Prod. **113**, 792–806 (2016)
9. Lozano, R.: Proposing a definition and a framework of organisational sustainability: a review of efforts and a survey of approaches to change. Sustainability **10**(4), 1157–1177 (2018)
10. Böhm, R.: System-Entwicklung in der Wirtschaftsinformatik, 5th edn. VDF Hochschulverlag AG an der ETH Zürich, Zürich (2015)
11. Scheer, A.-W.: ARIS - Modellierungsmethoden, Metamodelle, Anwendungen, 3rd edn. Springer, Berlin (1998)
12. De Lange, J.: Prozessmodell für den Werkzeugbau im iterativen Produktentwicklungsprozess. Dissertation, RWTH Aachen (2020)
13. Schmitt, R.H., Buschmann, D., Briele, K., Schlegel, P., Ellerich, M.: Nachhaltige Produktion durch Predictive Quality und Sustainability Analytics entlang der Lieferkette. In: Trauth, D., Bergs, T., Prinz, W. (eds.) Monetarisierung von technischen Daten, pp. 521–536. Springer, Heidelberg (2021). [https://doi.org/10.1007/978-3-662-62915-4\\_26](https://doi.org/10.1007/978-3-662-62915-4_26)
14. Jawahir, I., Bradley, R.: Technological elements of circular economy and the principles of 6R-based closed-loop material flow in sustainable manufacturing. Procedia CIRP **40**, 103–108 (2016)




**Open Access** This chapter is licensed under the terms of the Creative Commons Attribution 4.0 International License (<http://creativecommons.org/licenses/by/4.0/>), which permits use, sharing, adaptation, distribution and reproduction in any medium or format, as long as you give appropriate credit to the original author(s) and the source, provide a link to the Creative Commons license and indicate if changes were made.

The images or other third party material in this chapter are included in the chapter's Creative Commons license, unless indicated otherwise in a credit line to the material. If material is not included in the chapter's Creative Commons license and your intended use is not permitted by statutory regulation or exceeds the permitted use, you will need to obtain permission directly from the copyright holder.





# Integration of Digitization and Sustainability Objectives in a Maturity Model-Based Strategy Development Process

Marc Münnich<sup>1</sup>(✉) , Maximilian Stange<sup>1</sup> , Marian Süße<sup>1</sup> ,  
and Steffen Ihlenfeldt<sup>1,2</sup>

<sup>1</sup> Fraunhofer Institute for Machine Tools and Forming Technology IWU, Chemnitz, Germany  
marc.muennich@iwu.fraunhofer.de

<sup>2</sup> Institute of Mechatronic Engineering, Technische Universität Dresden, Dresden, Germany

**Abstract.** Political, technological and economic changes force manufacturing companies to shift their strategic alignment towards green and digitized technologies. The parallel advances in those technologies raise questions regarding economic, environmental and social sustainability issues that are challenging to integrate into corporate strategy. Recently, sustainable energy supply has gained additional attention as a critical resource for production. Digital transformation is a diverse intracompany process and requires adequate strategies. Maturity models are a well-known and established approach to define strategic improvement measures. Various versions of separate maturity models to either examine the current state of digitization or sustainability have been developed and there are few models to support both dimensions adequately. Therefore, the authors propose a strategy development process, which utilizes a combined maturity model for both domains in one framework. A review on sustainability-related maturity models as well as the connection to digitization aspects is conducted. Based on this, an existing model is extended. The model is tested in a case study to compare the impact of the models' adaptations.

**Keywords:** Digitization · Sustainability · Maturity Model

## 1 Introduction

Digital transformation and the related broader concept of digitization are seen as a current necessity for small and medium sized enterprises (SMEs) to stay competitive. Besides the purely economic necessity of the digital transformation of SMEs, it is reasonable to assume that digitization will help reduce the negative environmental impact of business activity. Contrarily, digitization plays an ambivalent role in this field of tension since it allows products to be manufactured more (resource-)efficient, but using digital technologies is also associated with a considerable input of resources.

According to Chen et al., the effects of digitization on sustainability in the corporate context can be traced back to two areas. The first is the impact of digital technologies on the life cycle of the manufactured product and the second is the life cycle impact of

the hardware used for digitization [1]. Their research conducts that a positive effect of digitization on environmental sustainability is assumed or established in most publications. However, the authors also report that it has been challenging to find publications that present both positive and negative impacts of digitization on sustainability.

In a review of six companies in the logistics industry, Kayikci found that the efforts of the companies studied with regard to their digital transformations were mainly aimed at improving economic sustainability and the influence on environmental and social sustainability was rather low [2]. Brozzi et al. can confirm this assessment in a study of Italian SMEs. At present, most companies in the manufacturing sector do not see digitization primarily as a tool for improving economic and social sustainability [3].

Hence, manufacturing industry, especially in Germany with a predominant share of SMEs, requires support and guidance to handle these new challenges. To cope with these requirements, we propose the extension of an extensively tested strategy development process that engages a maturity model for digitization in its center and we extend it for sustainability considerations. The objective of the model is to provide more options in strategy development processes that incorporate sustainability in terms of social, economic and ecological aspects.

## 2 Maturity Models for Corporate Strategy Development

### 2.1 Maturity Models for Digitization and Sustainability

Maturity models can be used as a tool for assessing organizational capabilities in a specific domain [4]. They can be applied to assess the current position of a company and aid companies in their continuous improvement by showing expected, desirable or characteristic development patterns of certain objects or processes within a company [5]. Due to their structure, a prioritization of improvements is simple.

Basic and well-established models for the elaboration of a current digitization status and appropriate improvement measures exist in many versions. Examples are the web-based Industry 4.0 Readiness Model [6] and the scientifically grounded model by Schumacher et al. [7]. Either of them serves as a static document with qualitative description of different digitization levels. Mittal et al. give a comprehensive review on maturity models for Industry 4.0 and their implication on SMEs [8].

Furthermore, a range of sustainability-oriented maturity models with different scopes have been established. Baumgartner and Ebner [9] examine specific aspects of corporate sustainability strategies. They identify different types of strategies and a maturity model helps them to characterize each strategy within the sustainability dimensions more precisely. They derive different sustainability aspects from international standards and guidelines as well as academic literature and focus on economic, environmental and social dimensions to frame the aspects of corporate sustainability.

Golinska and Kübler [10] propose a framework for the sustainability assessment of SMEs of the remanufacturing sector. The maturity model is based on ISO/IEC 15504 Information technology - Process assessment [11]. It is embedded within a questionnaire and also utilizes the three dimensions of sustainability. The questions serve as description of the maturity levels and each level requires the former level to be fulfilled.

Müller and Pflieger [12] contribute a maturity and decision model as a support tool for sustainable corporate decisions. They provide improvement strategies by considering corporate activities, the sustainability dimensions and their respective maturity level (Sustainability Maturity Cube). The model itself is a blueprint that enables the development of specific maturity models. Hence, a set of levels and their respective characteristics are not provided.

Other sustainability maturity models set a more specific application focus. Pigosso et al. [13] and Hynds et al. [14] developed maturity models exclusively for product development. Cagnin et al. [15] provide a maturity model to support companies move towards sustainable development. The 35 introduced levels extend the three main pillars by spatial and institutional-political sustainability. Reefke et al. [16] focus on decision-making stages of sustainable supply chain management and propose specific maturity model with corresponding goals and requirements to implement a sustainable supply chain strategy.

In conclusion, many of the introduced models embed the three pillars of sustainability to define dimensions and maturity levels. The development of the dimensions, categories and levels is mainly motivated by existing standards and academic literature. In addition, empirical studies are conducted to identify relevant evaluation categories. These findings implicate that the three pillars of sustainability are a well-known and widely applied approach for maturity models.

### 3 Extending the Existing Maturity Model and Analysis Process

#### 3.1 Methodical Approach of the Existing Potential Analysis

The already developed procedure to identify and enhance digitization potentials consists of the following three major steps as shown in Fig. 1, which are elaborated in [17] and [18]. Step 2 is designed as a workshop-oriented analysis of the self-assessment and the internal processes according to the maturity models TOP-dimensions *Technology* including the product and process view, *Organization* and *Personnel* with its 120 levels in total to describe the state of digitization. The dimension of *Energy* has been included to examine the awareness of energetic aspects in companies.

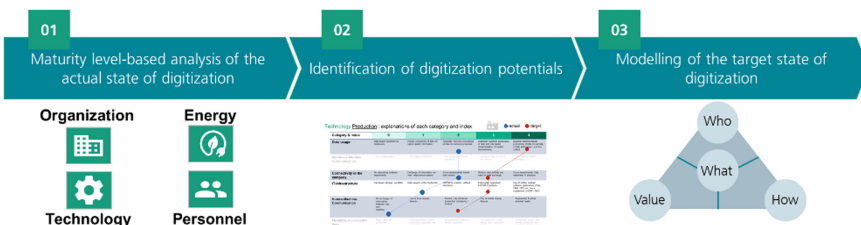


Fig. 1. Current workflow scheme of potential analysis

Based on Finnerty et al. [19], Benedetti et al. [20] and catalogues of measures by [21] and [22], 25 additional levels were identified and structured in the following categories:

- Record, processing and analysis of energy data,
- Measurement tools,
- Load management and peak loads,
- Activities for participation and fostering of energy awareness among employees,
- Energy supply systems of a company.

The elaborated gaps between actual and target state of digitization are a mean to generate ideas on how to define project concepts. This includes the use of the St. Gallen Business Model Navigator [23] in step 3. Therein, we adapted the dimensions towards the description of digitization strategies as follows:

- Who are the stakeholders of the digitization solution (e.g., involved personnel)?
- What is the value for the stakeholders (e.g., a new digital assistance system)?
- How is the project realized (e.g., what is necessary to implement the solution)?
- What is the created value for the stakeholders (e.g., ergonomic improvements)?

By applying these questions to the generated ideas, a conceptual roadmap for the realization of each idea is established that serves as a future project concept. The existing potential analysis procedure does not incorporate sustainability aspects and will therefore be extended by this aspect subsequently. Since it is designed for evaluating manufacturing companies and not to support strategy development for e.g., supply chains or service providers, sources of these domains will be excluded in the next steps of model development.

### 3.2 Extensions Towards Sustainability-Related Aspects

In Sect. 2 identified maturity models serve as a source of dimensions and respective categories for our model extension. The models incorporate the pillars of sustainability, which are underpinned with specific categories, e.g., social sustainability addresses the health and safety of workers. In order to cover the effects more comprehensively, we extended the review of maturity models by reviews and case studies with focus on digitization and sustainability.

Exemplarily, Chen et al. [1] give an extensive insight into the tension field of digitization and environmental sustainability in manufacturing. They discussed the implications of digitization on the Triple Bottom Line. Beltrami et al. [24] performed a review on Industry 4.0 technologies and their effect on environmental, social and economic performance. Stock et al. [25] elaborate the potential for sustainable value creation in Industry 4.0 the literature review and expert interviews. Sartal et al. [26] examine the influence of Industry 4.0 on sustainable manufacturing. They describe the evolution of sustainable manufacturing over time and applied tools (e.g., Life Cycle Assessment), standards and metrics (e.g., ISO14001) and concepts (e.g., Triple Bottom Line). They include Industry 4.0 technologies (e.g., Simulation systems) and their main benefits towards sustainable manufacturing and pointed out other relevant frameworks within this area. One of these frameworks is authored by Trianni et al. [27] who empirically elaborated a wide range of Triple Bottom Line indicators among 26 SME across Germany and Italy in various sectors. In sum, 18 indicators across the three dimensions were identified with the result

that the majority only focus on the economic pillar of sustainability while the social and environmental are only addressed for compliance reasons.

The focus in both, reviews and maturity models are on the three pillars of sustainability, respectively the Triple Bottom Line concept as a variation of this approach [28]. Also, the categories within the dimensions address similar topics. Hence, we utilize these intersections to extend our model by the main categories of the conducted review in Sect. 2 and 3. In the following Table 1 we give an overview on the intersecting (and renamed) categories that are used to extend our model.

**Table 1.** Overview on the identified generic categories

No	Economic sustainability [EC]	Environmental sustainability [EN]	Social sustainability [SO]
1	Resource consumption and recycling [9, 26, 27]	Emissions into air, land, water [1, 9, 10, 24–27]	Healthcare and safety [9, 10, 25–27]
2	Process integration and productivity [9, 10, 24, 26, 27]	Dangerous inputs and wastes [1, 9, 10, 12, 24–27]	Ethical behavior and human rights [9, 12, 24]
3	Product cost and quality [10, 24, 26, 27]	Waste management and recycling [26, 27]	Human capital development [9, 27]
4	Economic growth and revenue [9, 12, 24–26]	Energy and resource consumption [1, 10, 12, 24, 25]	Ergonomic and safe work conditions [10, 12, 24–27]
5	Product and process innovation [9, 10, 26, 27]	Safety of workers and environment [9, 12, 26, 27]	Corporate responsibility [9, 10, 12, 25, 27]

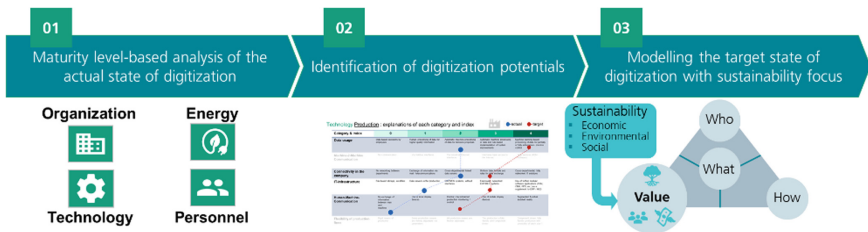
With respect to similar categories within the three dimensions, a distinction based on the definitions by Chen et al. is used to clarify the scopes of each dimension. For the detailed definitions, please refer to [1].

### 3.3 Implications on Potential Analysis Process

Based on our assumptions, we extended the potential analysis by energetic and sustainability considerations. More specifically, an energetic perspective extends the maturity model for analysis and self-assessment and the extracted sustainability dimensions extend the workflow of value analysis of project concepts. The final process is structured as presented in Fig. 2. To evaluate the method, it was applied on a project concept of a workshop. The investigated company produces brake lines for several automotive companies and supplies them by just-in-time principle. The process is characterized by bending, joining, heating and assembly processes, the facilities have a low level of digital surveillance and assistance systems. The work of the labor is mainly manual with a lot of paper-based documentation regarding process parameters, quality results and order tracking. For the company it is crucial to ensure supply reliability and therefore



the production itself is heavily reliant on the process quality to reach this goal. Thus, the reduction of quality losses is a main concern.



**Fig. 2.** Updated workflow scheme with energetic and sustainability consideration

We therefore developed a concept for an eddy-current testing with automatic result feedback loops in a critical joining process according to our version of the St. Gallen business model triangle. The initial “Value”-dimension focused on economic targets, e.g., decreased production planning cycles. An extension towards **economic sustainability** aspects may be cost savings in material purchase as well as less recycling costs [EC1] and better process integration into the workflow of the workers [EC2]. By correlating process parameters with quality states, a quality improvement can be assumed [EC3] as well as new opportunities for further data-driven process improvement are possible [EC5]. Hence, the initially identified cost reduction [EC4] also fosters revenue by less scrap and recycling costs [EC5]. **Environmental sustainability** is improved regarding less usage of resources and less energy consumption when stable production output is assumed [EN4]. Additionally, emissions are reduced within the production processes whereas additional emissions by the installation of the new sensor system and software can be assumed as comparably low [EN1]. Dangerous inputs and wastes [EN2] are a minor concern and therefore not contemplated in detail. Waste management benefits from less scrap materials [EN3] and the process adaptations do not foster major health risks for workers or environmental risks [EN5]. **Social sustainability** is enhanced in terms of better working conditions due to less secondary processes, e.g., documentation [SC4]. Workers are supported by a digital solution, which also requires labor training and therefore improvement of skill sets [SC3]. Furthermore, it is important to also ensure an ethical usage of the digital solution, e.g., by avoiding employee tracking [SC2]. External effects of [SC1] and [SC5] are less relevant for the use case. The analysis of the **dimension Energy** revealed a high level of energetic maturity, established by retrofitted machines but not used further, that is contrary to the levels of digitization across TOP-dimensions. Energy-intensive processes were controlled by organizational measures in terms of energy efficiency. The further digitization of the contiguous processes offers more options for data-driven measure application in various production areas.

## 4 Conclusion

The implications of digitization on sustainability gain increasing attention in academic literature, the estimation of positive and negative effects remains difficult and case specific. The prevailing view is that sustainability can be affected positively and adequate assessment methods need to be provided for companies. Thus, we proposed an extension of an existing and in many workshops approved potential analysis workflow for digitization by aspects of economic, environmental and social sustainability. We extended the component of business model evaluation in the workflow by sustainability considerations and evaluated the adapted workflow with a case study. The extension helped to clearly determine boundary conditions within the evaluation process.

Next steps can be the modular extension of the maturity model itself by sustainability domains. Also, concrete use cases with detailed descriptions of technologies, transformation processes and the evaluation of influences between sustainability and digitization would be helpful for practitioners. In addition, more use cases with environmental and social focus may be identified and scrutinized in the future.

**Acknowledgment.** The authors gratefully acknowledge the financial support of the “Mittelstand Digital Zentrum Chemnitz” (01MF21007B) by the Federal Ministry for Economic Affairs and Climate Action (BMWK) and the project supervision by the project management organization Projektträger Deutsches Zentrum für Luft- und Raumfahrt e.V. (DLR).

## References

1. Chen, X., Despeisse, M., Johansson, B.: Environmental sustainability of digitalization in manufacturing: a review. *Sustainability* **12** (24) (2020)
2. Kayikci, Y.: Sustainability impact of digitization in logistics. *Procedia Manuf.* **21**, 782–789 (2018)
3. Brozzi, R., Forti, D., Rauch, E., Matt, D.T.: The Advantages of Industry 4.0 Applications for Sustainability: results from a sample of manufacturing companies. *Sustainability* **12**(9), 3647 (2020)
4. Rosemann, M., de Bruin, T.: Towards a business process management maturity model. In: Proceedings of the Thirteenth European Conference on Information Systems, Regensburg. 26–28 May 2005
5. Becker, J., Knackstedt, R., Pöppelbuß, J.: Developing maturity models for IT management. *Bus. Inf. Syst. Eng.* **1**(3), 213–222 (2009)
6. Goerliche, D., Lichtblau, K., Stich, V. Industry 4.0 readiness online self-check for businesses. <https://www.industrie40-readiness.de/?lang=en>
7. Schumacher, A., Erol, S., Sihni, W.: A Maturity Model for assessing Industry 4.0 readiness and maturity of manufacturing enterprises. *Procedia CIRP* **52**, 161–166 (2016)
8. Mittal, S., Khan, M.A., Romero, D., Wuest, T.: A critical review of smart manufacturing & Industry 4.0 maturity models: Implications for small and medium-sized enterprises (SMEs). *J. Manuf. Syst.* **49**, 194–214 (2018)
9. Baumgartner, R.J., Ebner, D.: Corporate sustainability strategies: sustainability profiles and maturity levels. *Sust. Dev.* **18**(2), 76–89 (2010)

10. Golinska, P., Kuebler, F.: The method for assessment of the sustainability maturity in remanufacturing companies. *Procedia CIRP* **15**, 201–206 (2014)
11. International Organization for Standardization. ISO/IEC 15504-5:2012 Information technology - Process assessment - Part 5: An exemplar software life cycle process assessment model, Genf (2012)
12. Müller, A.-L., Pflieger, R.: Business transformation towards sustainability. *Bus. Res.* **7**(2), 313–350 (2014)
13. Pigosso, D.C.A., Rozenfeld, H., McAloone, T.C.: Ecodesign maturity model: a management framework to support ecodesign implementation into manufacturing companies. *J. Clean. Prod.* **59**, 160–173 (2013)
14. Hynds, E.J., et al.: A Maturity model for sustainability in new product development. *Res. Technol. Manag.* **57**(1), 50–57 (2014)
15. Cagnin, C., Loveridge, D., Butler, J. (Eds.): *Business Sustainability Maturity Model* (2005)
16. Hendrik Reefke, M., Ahmed, D., Sundaram, D.: Sustainable supply chain management—decision making and support: the SSCM maturity model and system. *Glob. Bus. Rev.* **15**, 1–12 (2014)
17. Langer, T., Singer, A., Wenzel, K., Bolev, D.: Modulbaukasten Digitalisierung. *Zeitschrift für wirtschaftlichen Fabrikbetrieb* **112**(12), 902–906 (2017)
18. Münnich, M., Süße, M., Bolev, D., Langer, T.: Einsatz einer Industrie 4.0-Potenzialanalyse zur methodischen und strukturierten Identifikation von Digitalisierungsmöglichkeiten. In: Bosse, C.K., Zink, K.J. (eds.) *Arbeit 4.0 im Mittelstand*, pp. 153–175. Springer, Heidelberg (2019). [https://doi.org/10.1007/978-3-662-59474-2\\_10](https://doi.org/10.1007/978-3-662-59474-2_10)
19. Finnerty, N., Sterling, R., Coakley, D., Keane, M.M.: An energy management maturity model for multi-site industrial organisations with a global presence. *J. Clean. Prod.* **167**, 1232–1250 (2017)
20. Benedetti, M., et al.: Maturity-based approach for the improvement of energy efficiency in industrial compressed air production and use systems. *Energy* **186** (2019)
21. Münnich, M., Rein, D., Reinhardt, H., Ihlenfeldt, S.: Identifying efficiency and flexibility measures for energy-oriented factory management. *Procedia CIRP* **105**, 302–3 (2022)
22. Stoldt, J., Wolf, T., Büttner, T., Schlegel, A., Langer, T., Putz, M.: Energieflexibilität im Maschinen- und Anlagenbau. *Zeitschrift für wirtschaftlichen Fabrikbetrieb* **113**(3), 124–127 (2018)
23. Gassmann, O., Frankenberger, K., Csik, M. (eds.): *Carl Hanser Verlag GmbH & Co. KG*, München (2017)
24. Beltrami, M., Orzes, G., Sarkis, J., Sartor, M.: Industry 4.0 and sustainability: towards conceptualization and theory. *J. Clean. Prod.* **312** (2021)
25. Stock, T., Obenaus, M., Kunz, S., Kohl, H.: Industry 4.0 as enabler for a sustainable development: a qualitative assessment of its ecological and social potential. *Process Saf. Environ. Prot.* **118**, 254–267 (2018)
26. Sartal, A., Bellas, R., Mejías, A.M., García-Collado, A.: The sustainable manufacturing concept, evolution and opportunities within Industry 4.0: a literature review. *Adv. Mech. Eng.* **12**(5) (2020)
27. Trianni, A., Cagno, E., Neri, A., Howard, M.: Measuring industrial sustainability performance: empirical evidence from Italian and German manufacturing small and medium enterprises. *J. Clean. Prod.* **229**, 1355–1376 (2019)
28. Purvis, B., Mao, Y., Robinson, D.: Three pillars of sustainability: in search of conceptual origins. *Sustain. Sci.* **14**(3), 681–695 (2018). <https://doi.org/10.1007/s11625-018-0627-5>

**Open Access** This chapter is licensed under the terms of the Creative Commons Attribution 4.0 International License (<http://creativecommons.org/licenses/by/4.0/>), which permits use, sharing, adaptation, distribution and reproduction in any medium or format, as long as you give appropriate credit to the original author(s) and the source, provide a link to the Creative Commons license and indicate if changes were made.

The images or other third party material in this chapter are included in the chapter's Creative Commons license, unless indicated otherwise in a credit line to the material. If material is not included in the chapter's Creative Commons license and your intended use is not permitted by statutory regulation or exceeds the permitted use, you will need to obtain permission directly from the copyright holder.





# Implications of Strategic Orientation on Sustainable Performance and Organizational Innovation: A Case of Manufacturing SMEs in Sub-Saharan Africa

Peter Onu<sup>(✉)</sup>, Anup Pradhan, and Charles Mbohwa

University of Johannesburg, Johannesburg 2092, South Africa  
onup@uj.ac.za

**Abstract.** The ability of manufacturing small and medium-sized enterprises (SMEs) to adopt sustainability is predicated on several criteria, including purchasing and developing specialized resources. SMEs in emerging economies have great potential, and in terms of intensifying business performance, it is important to focus on strategic orientation. The influence of four strategic orientations on firm performance is examined in this study. The role of learning, entrepreneurial, technological, and environmental orientations within proactive strategic orientations in the manufacturing sector have been investigated. This study uses a survey questionnaire to collect data from four hundred and sixty-five sub-Saharan African manufacturing SMEs. The proactive strategic orientations were advantageous for organizational innovation (OI) and sustainable performance (SP); OI improves SP, and SP catalyzes OI, based on the Pearson correlation coefficient. This research provides information that may be utilized to advance conceptual and practical debates on manufacturing SMEs to be innovative and improve their sustainability performance to contribute to society, the environment, and the economy.

**Keywords:** Manufacturing SMEs · Strategic orientations · Proactiveness

## 1 Introduction

In the industrial sector, concerns regarding sustainability are more prevalent than ever. Manufacturers must pay increasing attention to resource use, waste management, water pollution, employee welfare, and other issues as they face increased product demand. If these sustainability issues are not addressed, the company's reputation will suffer, and its performance will suffer as well. The concept of business sustainability is based on the idea of long-term growth. This is defined as "development that meets current demands without risking future generations' ability to meet their own needs." [1]. The present study offers a broad view, arguing that manufacturing SME performance is impacted more by the creation of a specific unique approach towards implementing proactive strategic orientations than just by the application of a particular sustainable manufacturing technique. As such, innovation and sustainable performance in SMEs in

developing economies are required to promote resource use, improved products, and unprecedented industrialization.

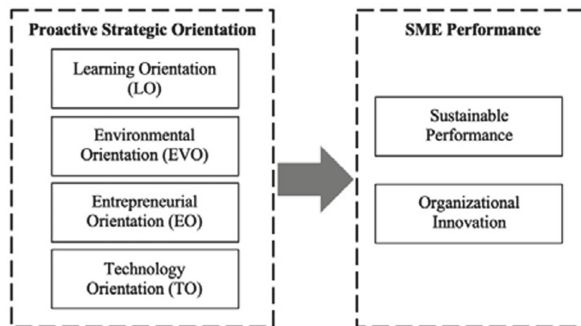
As a result, the article investigates the effect of four dimensions of strategic orientation that underpins organizational success, i.e., the dimensions through which sustainable manufacturing manifests, and assesses their impact on SME's performance [2]. Second, this article proposes many causal reasons for the link between strategic orientations in manufacturing SMEs and implementation, implying that the strategic orientation functions play an important role in the company's strategic planning process and, in general, should be strengthened. Thus, a questionnaire was used to collect data from SMEs within Western Africa, Eastern Africa, and Southern African (South Africa) manufacturing sector as part of the research project "The development of a sustainable manufacturing implementation model for small and medium-sized enterprises." This paper's findings can be utilized as a guideline to encourage the systematic deployment of Proactive Strategic Orientation (PSO) in manufacturing SMEs; in particular, 1) learning orientation; 2) entrepreneurial orientation; 3) technology orientation; and 4) environmental orientation to increase organizational innovation and sustainable performance in developing countries.

## 2 Theoretical Background

Accordingly, proactivity substantially influences the innovation process, the "willingness to act and make a competitor response" [3]. In manufacturing, a proactive strategy improves cost advantage and competitiveness by creating and acquiring new competencies [4]. Innovation is associated with creating a new product, service, or even a method that differs from the current. In contrast, innovation readiness, or innovativeness, is defined as the propensity to innovate. Also, meeting Sustainable Performance (SP) is crucial to fostering employee success while providing discretion in decision-making and distributing knowledge that can aid in the alignment of the company's financial, environmental, and social objectives in achieving its primary business objectives [5]. Research [6–8] suggests that monitoring the trends and indicators of sustainable performance is critical to measuring progress. Integrating new efforts and aligning them with corporate goals is vital while the number of studies on PSO is steadily rising. The present research aims to understand better the interaction between entrepreneurial orientation, learning orientation, technological orientation, and environmental orientation in manufacturing SMEs.

Entrepreneurial Orientation (EO) is an essential notion to consider when discussing business strategies. EO is a critical aspect that assists an organization in discovering new market possibilities [9, 10]. It is argued that a business that uses EO is more likely to identify new market possibilities [11, 12] and manage new obstacles such as an unpredictable environment and competition [13]. Learning orientation (LO) is a fundamental attitude toward learning, i.e., organizational and management traits that enhance the corporate learning process [14]. In this context, LO is defined as a company's values that impact the company's propensity to produce and use knowledge for business development [14], which is a significant predictor of SMEs Performance [15]. Recently, Technology Orientation (TO) has received much attention for supporting innovation [16–18].

Gatignon and Xuereb investigated the effect of TO in boosting the success of new product creation. They concluded that organizations with a strong TO are more likely to create new products and processes [19]. However, the direct link between TO and company performance has received less attention in the literature [20], and the relationships between these two variables remain equivocal. Environmental Orientation (EVO) denotes the strategic choice to include environmental goals into a firm's tactical, operational, and inventive actions to meet internal values while also responding to external market constraints [21–25]. EVO depend on selection, monitoring, and collaboration criteria to bolster firm performance. Moreover, research concerning the effects of environmental orientations on the likelihood that SMEs introduce a product or process innovations is trending [12]. This research offers a conceptual model illustrated in Fig. 1 for manufacturing SMEs as a result of analyzing the impact of proactive strategic orientation on SME performance. Thus, the model examines the relationship between learning orientation, entrepreneurial orientation, technology orientation, and environmental orientation as elements of the variable proactive strategic orientations on the variable SME performance by measuring sustainable performance and organizational innovativeness.



**Fig. 1.** Conceptual model of the implication of PSO on SME performance

### 3 Materials and Methods

This section describes the study and techniques, operationalized constructs, target groups, and data collection instruments.

#### 3.1 Description of Variables and Questionnaire Development

The purpose of this study was to see how four independent factors affected the dependent variable, which was business performance. The independent variable in this article was proactive strategic orientation, which was based on the work of [26–28], and resulted in a set of indicators for 1) learning orientation 2), entrepreneurial orientation 3), technological orientation 4), and environmental orientation. Though the present study focuses on these four dimensions as a key component of proactive strategic orientation, our discussion may differ because we debated each dimension separately in each situation. Two

follow-up questions were used to assess the dependent variable business performance: 1) whether the implemented orientations aided in improving sustainable practices (to measure sustainable performance, (SP) and 2) if it enhanced the organization's ability to deploy additional forms of innovation (to measure organizational innovativeness, OI). These inquiries were developed in response to theoretical concerns, and they were only asked if PSO had previously been implemented.

On a seven-point scale, the independent and dependent factors describing the SME performance were rated from 1 (not utilized) to 7 (completely implemented). Questions, which indicated the contribution to corporate duties, were scored on the scale ranging from one (strongly disagree) to seven (strongly agree). On an interval scale, variables capable of measuring follow-up parameters were derived and quantitatively examined. Intellectuals and professionals familiar with the research topic reviewed the planned survey questionnaires, and some were changed based on expert suggestions. This research focuses on the impact of proactive strategic orientations on sustainable performance and organizational innovation in manufacturing SMEs, allowing for separation between organizations that have done well based on the adoption of specific reputation ratings and innovations to bolster business performance. The survey also helps us determine the extent to which sustainable performance and innovation have been adopted (from not being adopted at all to being applied throughout the company).

### 3.2 Sample and Data Collection

The questionnaire was addressed to commercially involved manufacturing SMEs in Nigeria, Ghana, Kenya, Ethiopia, Uganda, Botswana, Zimbabwe, and South Africa. This paper is based on the European Commission Recommendation 2003/361 on the definition of micro, small, and medium-sized companies (SMEs), which employs the staff headcount criterion to identify businesses with fewer than 250 employees. The simple random method was utilized, which allowed us to acquire a significant number of responses and data from over 400 firms. To exclude responders that were not structurally developed or unable to adequately describe their corporate obligations and innovation processes, must have been at minimum three years old. The group contacted 1,842 manufacturing SMEs and completed 472 interviews with top managers, with seven surveys being deleted owing to missing data of more than 25%. As a result, the final sample totaled 465. From August 2020 to January 2021, a response rate of 25.24% was recorded. In terms of the industry type, wood manufacturing (e.g., manufacturing of wood and wood products, pulp and paper and paper products), basic metal manufacturing (e.g., metal and fabricated metal products), and other manufacturing enterprises account for 32.87%, 34.40%, and 32.73%, respectively (e.g., non-metallic mineral products, rubber and plastic products, and textile and textile products). The authors investigate significant links between the research variables in the proposed research model using one-way ANOVA and Pearson Correlation.

## 4 Results

Following the study's descriptive statistics, entrepreneurial orientation is the most widely used form of proactive strategic orientation (PSO) in manufacturing SMEs (mean score:



5.79), followed by environmental orientation (mean score: 5.31), technology orientation (mean score: 4.85), and learning orientation (mean score: 3.89), according to senior managers. More than half of the businesses questioned (61.3%) had not implemented a learning strategy. 11.5% had it implemented across the board, 34.7% had not implemented environmental orientation, 17.6% had it fully implemented, and 19.5% had not implemented entrepreneurial orientation. 21.4% had completely implemented it, whereas 33.7% had not, compared to 19.4% who had implemented the technology orientation. Several factors affected PSO's implementation.

The first factor is the number of employees: the greater an organization's workforce, the more likely it is to adopt PSO. For example, 71.4% of micro-firms had not implemented learning orientation, compared to 53.9% of small and 41.4% of medium-sized companies; 46.2% of micro-companies had not implemented environmental orientation, particularly compared to 19.9% of small and 21.4% of medium-sized companies; and 44.8% had not implemented technology orientation, compared to 31.9% of small and 29.3% of medium-sized enterprises. Learning orientation ( $F(2,395) = 22.357, p = .000$ ), environmental orientation ( $F(2,885) = 10.720, p = .004$ ), and technology orientation ( $F(2,995) = 21.800, p = .001$ ) were all statistically significant, with the exception of entrepreneurial orientation, as determined by one-way ANOVA. Second, PSO adoption was tied to annual turnover, much like the number of personnel. Learning orientation ( $F(8,885) = 11.558, p = .010$ ), environmental orientation ( $F(8,387) = 4.679, p = .001$ ), entrepreneurial ( $F(7,395) = 2.226, p = .010$ ), and technology orientation ( $F(7,495) = 8.120, p = .000$ ) were all statistically significant. Third, the one-way ANOVA revealed a statistically significant difference in entrepreneurial ( $F(3,795) = 4.150, p = .070$ ) and technology orientation ( $F(4,985) = 4.927, p = .001$ ), based on the type of business. Fourth, the study discovered regional differences in the likelihood of manufacturing SMEs employing PSOs. When considering the regions or countries of large economies, one-way ANOVA revealed a statistically significant difference between groups for learning orientation ( $F(3,295) = 3.345, p = .041$ ) and environmental orientation ( $F(3,785) = 3.715, p = .011$ ). In contrast, when considering smaller economic countries, one-way ANOVA revealed a statistically significant difference between groups for learning orientation ( $F(5,095) = 3.074, p = .021$ ).

Furthermore, when it came to the influence of strategic orientations on sustainable performance and organizational innovation, top managers from the companies implementing PSO agreed that it had helped them become more dynamic and accountable for corporate sustainability. More than half of senior managers (57.6%) said that implementing PSO helped them increase SP; 19.6% gave this statement a five or higher rating, while 17.11% gave it a three or lower rating. Similarly, 68.5% of top executives acknowledged that the organization's ability to implement OI and other innovations, such as newer products, services, or marketing strategies; 41.2% gave it a five or higher rating, while 11.7% gave it a three or lower rating.

The impact on SP was rated as 5.14 for organizations which had implemented at least one type of PSO to an average (above 5), 5.61 for those who had implemented two forms of PSO, and 5.44 for those who had implemented three or four types of PSO. Similarly, firms that had not implemented any PSO evaluated the effect on OI on aggregate at 4.34, for those who had deployed one type of PSO, 4.38 for those who had deployed

two forms of PSO, and 5.80 and 5.20 for those who had deployed three or four kinds of PSO, respectively. The Pearson correlation for the overall PSO index between SP and OI was 0.494, and 0.425. Table 1 illustrates the Pearson correlation coefficients for each category, based on only those businesses that had adopted a certain type of PSO. Environmental orientation was the most successful form of PSO in terms of SP (Pearson correlation 0.484) and OI (Pearson correlation 0.402), technology orientation (Pearson correlation 0.417 for SP and 0.391 for OI). Firms who considered PSO advantageous towards meeting SP also saw it as beneficial for OI (Pearson correlation 0.776, for medium-sized business 0.780). This confirms that PSO is beneficial for manufacturing SMEs since organizational innovativeness (OI) improves sustainable performance (SP), and SP catalyses OI.

**Table 1.** Correlation matrix for sustainable performance and organizational innovation

	Sustainable performance (SP)	Organizational innovation (OI)
Overall PSO Index	0.494	0.425
LO	0.314	0.298
EVO	0.484	0.402
EO	0.288	0.341
TO	0.417	0.391

## 5 Discussion

When it comes to PSO implementation, senior management reports suggest that entrepreneurial orientation is the most widely used form of PSO in manufacturing SMEs in Sub-Saharan Africa, followed by environmental and technological orientations, while learning orientation is the least commonly used. 11.8% of the enterprises polled had not adopted any type of PSO, while 38.4% had partly implemented all strategic forms of PSO. At the same time, 28.8% of businesses had not implemented any PSO, 35.9% had implemented one type of PSO, 21.8% had implemented two, and 19.2% had executed more than two types of PSO. As a result, a variety of factors impacted the implementation of PSO. The more employees a company had, the more likely they were to adopt PSO (as reported in literature [29, 30]). The bigger the yearly turnover, the more probable PSO will be implemented, given accessible resources for new initiatives [31, 32]. Larger companies were more likely to innovate and contribute to corporate sustainability, mainly via learning and environmental orientation. This might be explained by the more diversified environment and more fierce competition in larger economies, which forces businesses to differentiate themselves more.

## 6 Conclusions and Research Prospects

The findings imply that proactive strategic orientation can influence organizational innovation and sustainable performance. Small businesses are more innovative than medium-sized enterprises, which are more innovative than microbusinesses. In addition, companies with a higher turnover are more innovative. Metal manufacturing businesses are more likely to include environmental orientation, wood manufacturing firms are more likely to incorporate entrepreneurialism, and 'other' manufacturing firms are less likely to innovate but eager to promote corporate responsibility. Furthermore, the proactive strategies identified in the study [33] were shown to be advantageous to enterprise innovation and sustainable performance; the more an organization uses organizational innovation, the more beneficial it is to that firm. The findings of the study imply that manufacturing SMEs, owners, or managers create and promote an organizational culture that encourages varied PSOs, resulting in higher dedication to the business and society and better opportunities for innovation. According to the study, manufacturing SMEs' owners and managers should involve members of their organizations in relatively new strategy development, resulting in a common understanding of the organization's vision and objectives as well as capturing fairly long-term innovation and development ideas that improve corporate performance.

## References

1. Brundtland, G.: WCED: Our Common Future. Oxford Pap. (1987)
2. Onu, P., Mbohwa, C.: Sustainable production: new thinking for SMEs. *J. Phys. Conf. Ser.* **1378**, 022072 (2019)
3. Covin, J.G., Wales, W.J.: The Measurement of Entrepreneurial Orientation. *Entrep. Theory Pract.* (2012)
4. Bhupendra, K.V., Sangle, S.: What drives successful implementation of pollution prevention and cleaner technology strategy? The role of innovative capability. *J. Environ. Manage.* **155**, 184–192 (2015)
5. de Jonge, J., Peeters, M.C.W.: The vital worker: towards sustainable performance at work. *Int. J. Environ. Res. Public Health* **16**(6), 910 (2019)
6. Bouloiz, H.: Sustainable performance management using resilience engineering. *Int. J. Eng. Bus. Manag.* **12**, 1–12 (2020)
7. Appiah-Nimo, C., Chovancová, M.: Improving firm sustainable performance: the role of market orientation. *Proc. Int. Conf. Bus. Excell.* **14**(1), 780–787 (2020)
8. Onu, P., Mbohwa, C.: Reimagining the future: techno innovation advancement in manufacturing. In: *Materials Today: Proceedings*, vol. 44, pp. 1953–1959 (2020)
9. Caseiro, N., Coelho, A.: The influence of Business Intelligence capacity, network learning and innovativeness on startups performance. *J. Innov. Knowl.* **4**, 139–145 (2019)
10. Chang, C.H.: How to enhance green service and green product innovation performance? The roles of inward and outward capabilities. *Corp. Soc. Responsib. Environ. Manag* **25**(4) (2017)
11. Gawke, J.C., Gorgievski, M.J., Bakker, A.B.: Measuring intrapreneurship at the individual level: Development and validation of the Employee Intrapreneurship Scale (EIS). *Eur. Manag. J.* **37**, 806–817 (2019)

12. Adomako, S., Amankwah-Amoah, J., Danso, A., Danquah, J.K., Hussain, Z., Khan, Z.: R&D intensity, knowledge creation process and new product performance: the mediating role of international R&D teams. *J. Bus. Res.* **128**, 719–727 (2021)
13. Clausen, T.H.: Entrepreneurial thinking and action in opportunity development: a conceptual process model. *Int. Small Bus. J. Res. Entrep.* **38**(5) (2020)
14. Real, J.C., Roldán, J.L., Leal, A.: From entrepreneurial orientation and learning orientation to business performance: Analysing the mediating role of organizational learning and the moderating effects of organizational size. *Br. J. Manag.* **25**(2) 186–208 (2014)
15. Arshad, M.Z., Meirun, T., Javaid, M., Ali, M., Arshad, M.H., Maneerat, C.: The importance of learning orientation and entrepreneurial orientation on SMEs performance. *Int. J. Disaster Recover. Bus. Contin.* **14**(2) (2020)
16. Ramírez-Solis, E.R., Llonch-Andreu, J., Malpica-Romero, A.D.: How beneficial are relational capital and technology orientation for innovation? Evidence from Mexican SMEs. *Int. J. Innov. Stud.* **6**, 1–10 (2022)
17. Al Idrus, S., Abdussakir, Djakfara, M.: The effect of entrepreneurial orientation and technology orientation on market orientation with education as moderation variable. *Manag. Sci. Lett.* **10**(10), 2351–2360 (2020)
18. Kocak, A., Carsrud, A., Oflazoglu, S.: Market, entrepreneurial, and technology orientations: impact on innovation and firm performance. *Manag. Decis.* **55**(2), 248–270 (2017)
19. Gatignon, H., Xuereb, J.M.: Strategic orientation of the firm and new product performance. *J. Mark. Res.* **34**, 77 (1997)
20. Frambach, R.T., Fiss, P.C., Ingenbleek, P.T.M.: How important is customer orientation for firm performance? A fuzzy set analysis of orientations, strategies, and environments. *J. Bus. Res.* **69**, 1428–1436 (2016)
21. Danso, A., Adomako, S., Lartey, T., Amankwah-Amoah, J., Owusu-Yirenkyi, D.: Stakeholder integration, environmental sustainability orientation and financial performance. *J. Bus. Res.* **119**, 652–662 (2020)
22. Klassen, R.D., Mclaughlin, C.P., Klassen, R.D., Mclaughlin, C.P.: The impact of environmental management on firm performance the impact of environmental management on firm performance. *Strateg. Manag. J.* **42**(8), 1199–1214 (2016)
23. Peter, O., Mbohwa, C.: Industrial energy conservation initiative and prospect for sustainable manufacturing. *Procedia Manuf.* **35**, 545–551 (2019)
24. Onu, P., Mbohwa, C.: *Agricultural Waste Diversity and Sustainability Issues: Sub-Saharan Africa as a Case Study*. Academic Press (2021)
25. Onu, P., Mbohwa, C.: Industry 4.0 opportunities in manufacturing SMEs: sustainability outlook. *Mater. Today Proc.* **44**, 1925–1930 (2021)
26. Ardito, L., Raby, S., Albino, V., Bertoldi, B.: The duality of digital and environmental orientations in the context of SMEs: implications for innovation performance. *J. Bus. Res.* **123**, 44–56 (2021)
27. Lee, D.H., Choi, S.B., Kwak, W.J.: The effects of four dimensions of strategic orientation on firm innovativeness and performance in emerging market small- and medium-size enterprises. *Emerg. Mark. Financ. Trade.* **50**(5), 78–96 (2014)
28. Lei, L., Wu, X., Fu, Y.: Effects of sustainability and technology orientations on firm growth: Evidence from Chinese manufacturing. *Sustain.* **11**(16), 4406 (2019)
29. Schmidt, T., Rammer, C.: The determinants and effects of technological and non- technological innovations – evidence from the German CIS IV. *Ocde. SSRN J.* (2006)
30. Laforet, S.: Effects of organisational culture on organisational innovation performance in family firms. *J. Small Bus. Enterp. Dev.* **23**(2), 379–407 (2016)
31. Beer, M., Nohria, N.: *Cracking the code of change*. Harv. Bus. Rev. (2000)

32. Damanpour, F., Sanchez-Henriquez, F., Chiu, H.H.: Internal and external sources and the adoption of innovations in organizations. *Br. J. Manag.* **29**(5) (2018)
33. Onu, P., Pradhan, A., Mbohwa, C.: Implications of strategic orientation on sustainable performance and organizational innovation: a case of manufacturing SMEs in Sub-Saharan Africa. *J. Small Bus. Enterpr. Dev.* **19**(1), 132–145 (2022)

**Open Access** This chapter is licensed under the terms of the Creative Commons Attribution 4.0 International License (<http://creativecommons.org/licenses/by/4.0/>), which permits use, sharing, adaptation, distribution and reproduction in any medium or format, as long as you give appropriate credit to the original author(s) and the source, provide a link to the Creative Commons license and indicate if changes were made.

The images or other third party material in this chapter are included in the chapter's Creative Commons license, unless indicated otherwise in a credit line to the material. If material is not included in the chapter's Creative Commons license and your intended use is not permitted by statutory regulation or exceeds the permitted use, you will need to obtain permission directly from the copyright holder.





# Identification of Action Areas for the Promotion of Local Manufacturing in Reference to System Theory

Pascal Krenz<sup>(✉)</sup>, Lisa Stoltenberg, Dominik Saubke, and Julia Markert

Helmut-Schmidt-University, Holstenhofweg 85, 22043 Hamburg, Germany  
pascal.krenz@hsu-hh.de

**Abstract.** Industrial value creation today is characterised in many sectors by globally distributed processes for product manufacturing based on the division of labour in order to achieve advantages through specialisation, scale and location. However, the economic advantages of this form of value creation are being increasingly diminished by the current ecological and social challenges. Local manufacturing has the potential to be a piece of the puzzle in the complex transformation process towards a sustainable circular economy. However, suitable framework conditions are needed for the successful implementation of economically, ecologically and socially sustainable forms of local value creation. To be able to develop these in a targeted manner, knowledge regarding the areas influenceable by societal functional systems (e.g. politics, economy, production) and how they may affect the design dimensions of local manufacturing is necessary. A systems theory-based analysis is used to consider the influence of the operations of societal subsystems on local manufacturing, to identify decision spaces and to evaluate overarching couplings between the societal system operations.

**Keywords:** Local manufacturing · Collaborative value creation · Sustainable manufacturing · Circular economy · System theory

## 1 Introduction

The utilisation of the principles of a **circular economy** (CE) is ultimately indispensable to meet the ecological and social challenges of our time (reduction of greenhouse gases, preservation of biodiversity, protection of remaining natural land areas) [1]. **Local Manufacturing** offers considerable potential to promote the necessary transformation towards a sustainable circular economy, as it contributes to the reduction of value creation cycles (e.g. avoiding overproduction, reducing transport, involving regional stakeholders) [2–4]. Modern production technologies (e.g. additive manufacturing, mobile production units) and the digitalisation of the product creation process promote manufacturing for varying scales that adapt to local conditions and needs [2, 5–7]. The goal is to produce locally adapted products at the point of need for the current demand by involving regional stakeholders (local producers, knowledge carriers and customers) and resources (recyclable components and materials, materials from local recycling loops)

[2, 8]. The current trends of sustainability, individualisation and digitalisation fundamentally improve the potential for the development of local manufacturing. However, the economically successful implementation of competitive business models for patterns of local value creation is not yet foreseeable. The question arises as to which conditions must exist to facilitate the emergence of local value creation patterns and which societal systems (politics, economy, consumption, production, etc.) have an influence on shaping these areas.

## 2 Current Status and Objective of Research

Within the context of our research [4], the systematics of local manufacturing are investigated to achieve a more in-depth understanding of its internal functionality and to be able to derive recommendations for action in various areas of society. The basis is a sensitivity analysis according to Vester [9]. Based on a systematic analysis of texts dealing with the concepts of Distributed Manufacturing, Urban Manufacturing and Re-Distributed Manufacturing, various factors influencing local manufacturing were found [10]. Furthermore, five main attributes of local manufacturing were identified, which were assigned to three dimensions (location, resources, demands) (see Table 1).

**Table 1.** Dimensions and main attributes of local manufacturing

Dimension of LM	(A) Local production of goods	(B) Utilisation of local resources	(C) Addressing of local demands
Main attributes of LM	<ul style="list-style-type: none"> <li>○ Production at the place of need</li> </ul>	<ul style="list-style-type: none"> <li>○ Use of local (raw) materials</li> <li>○ Implementation of production by local stakeholders</li> </ul>	<ul style="list-style-type: none"> <li>○ On demand production</li> <li>○ Production of individualized / locally adapted products</li> </ul>

In a next step, the causal interrelations between the identified factors influencing the dimensions of local manufacturing were modelled, thus building a causal network. Subsequently the main chains of influence and ultimately key factors affecting local manufacturing were derived. The strength of the influences in regard to their short-term, medium-term and long-term effects was differentiated [4].

## 3 Approach for the Determination of Action Areas

Systems theory is a suitable approach for assigning the central influencing factors of local manufacturing to societal sub-areas. According to LUHMANN, a system defines itself by constantly distinguishing itself from its environment [11]. The overall system of modern society is differentiated into functional subsystems (e.g. politics, economy) in order to reduce complexity. Problems that arise can be dealt with in these functional systems [12]. Systems operate autopoietically, i.e. self-referentially, meaning they permanently reproduce themselves and their own structures [11] and can only operate within these self-(re-)produced structures (according to their own logic) [13].

At the same time, however, systems are in a reciprocal exchange and permanent development cycles with their environment through structural couplings [11, 13].

A system is thus adapted to its environment, but can also cause its environment [13]. The functional systems can only operate according to their own logic due to autopoiesis, i.e., the economic system, e.g., can only react economically to political or legal issues [12]. Operations of different functional systems can contradict each other (“operative difference”) [12]. Table 2 shows the six societal functional systems that will be considered in this paper including a short explanation of each one. These systems partly refer to Luhmann’s sociologically influenced explanations, but have been extended according to his logic in order to be able to represent the special case of local manufacturing.

According to Luhmann’s System Theory the systems **Politics** and **Law** depend on different logics, as shown in Table 2. Nevertheless, there was a large overlap to be found in their influence on the factors of this specific case of local manufacturing. Therefore, they are merged into the system **Politics/Law** for the rest of this paper.

**Table 2.** Overview of the considered societal functional systems

System	Description of System
Politics	The <b>system Politics</b> operates through legislation and political decision-making processes. Its operations are based on programmes that legitimise the attribution of power (e.g. elections, status). The results of the system are e.g. laws.
Law	The <b>system Law</b> operates through the interpretation of laws in the sense of dispensation of law/judging. The underlying programmes represent laws and forms of law-making that serve to decide true or untrue. The results are judgements as well as interpretations of laws.
Production	The <b>system Production</b> operates through the manufacturing of products. The operations are based on programmes that create a statement regarding whether something can be produced or not. These programmes are production concepts/methods. The system’s result is the product.
Engineering and Technology Sciences	The <b>system Engineering and Technology Sciences</b> operates through the development of knowledge about the manufacturing of products and related technical application areas. The programmes represent models, theories and research methods that can be used to make statements about whether assumptions are true or false.
Consumption	The <b>system Consumption</b> operates through the use of goods/services or the participation in processes. The result is the generation of benefits. The programmes represent benefit dimensions, needs and wants, which determine whether the satisfaction of needs/wants is successful.
Economy	The <b>system Economy</b> operates through trade or the implementation of transactions. The result is thus a successfully implemented transaction. The basis is formed, e.g., by programmes for pricing, investments or capital valuation, which provide information on whether a payment can be made or not.

The next part of the process was assigning the key influencing factors of local manufacturing to six functional systems according to Table 3 in an interdisciplinary workshop. The classification was decided according to the lead question of whether the programmes and results of the functional systems have a direct effect on their respective key influencing factors. Depending on the strength of the factor’s impact on a main attribute of local manufacturing (long-term development perspective) [4], a numerical value from 1 to 5 was assigned to the subsystem in case of a direct effect between functional system and key influencing factor (1 = low... 5 = essential).



**Table 3.** Allocation of key factors of local manufacturing to different functional systems

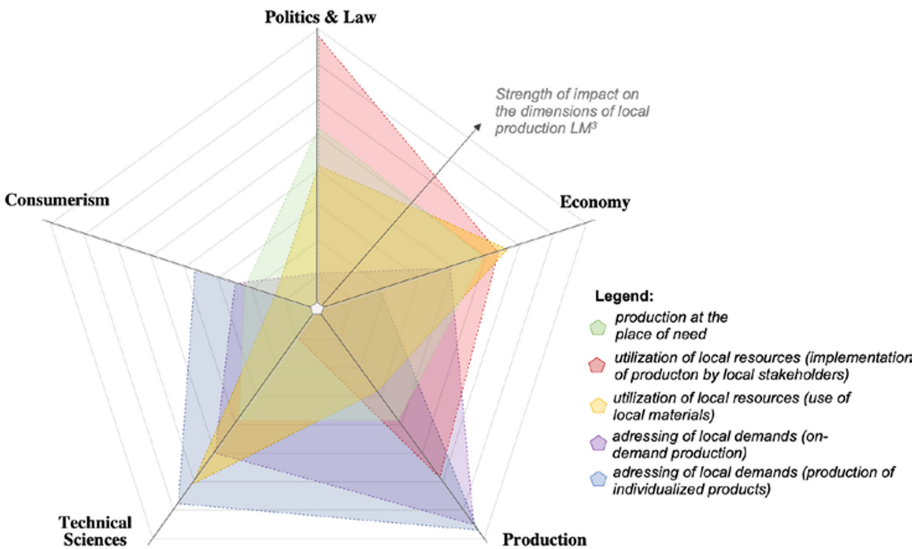
Main attribute	Factor	Politics / Law	Production	Eng. / tech. sci.	Consumption	Economy
	<b>Relative influence of the subsystems</b>	<b>26%</b>	<b>19%</b>	<b>19%</b>	<b>11%</b>	<b>25%</b>
Production at the place of need	Economic efficiency of local manufacturing	5	5	5		5
	Cost-efficient production of small series		2	2		2
	Risks and costs of global logistics			1		1
	Spatial concentration of demand	1			1	1
	Local infrastructure suitable for production	3	3	3		
	Demand for locally produced goods		4		4	4
	Acceptance of local manufacturing by residents	2	2			
	Local costs for production areas	3				3
	Spatial independence of R&D and Production		1	1		
	Competition for local land	2				2
	Trend: Sustainability	2		2	2	
Scarcity of space	1	1		1		
	<b>Relative influence of the subsystems</b>	<b>39%</b>	<b>29%</b>	<b>5%</b>	<b>0%</b>	<b>27%</b>
Utilization of local resources (implementation of prod. by local stakeholders)	Lower labour costs abroad	2				2
	Shortage of skilled workers on site	5	5			5
	Spatial proximity of the stakeholders	4	4			
	High local quality of life	2				2
	Economic efficiency of local manufacturing	1	1	1		1
	Prosperity in the region	1				1
	Local qualification opportunities	1				
	Positive image of companies		1			
	Visibility of production/producers		1	1		
		<b>Relative influence of the subsystems</b>	<b>24%</b>	<b>16%</b>	<b>27%</b>	<b>8%</b>
Utilization of local resources (use of local materials)	Insufficient availability of regional resources			2		2
	Processing of local resources	2	2	2		2
	Recycling	4	4	4		4
	Remanufacturing	4	4	4	4	4
	Risks and costs of global logistics	4		4		4
	Low disposal costs	1		1		1
	Low raw material prices	1		1		1
	Application of sustainable design principles		2	2		2
	Trend: Sustainability	2		2	2	
	Spatial proximity of the stakeholders	1	1			
		<b>Relative influence of the subsystems</b>	<b>5%</b>	<b>38%</b>	<b>25%</b>	<b>12%</b>
Addressing of local demands (on-demand prod.)	Product-specific storage costs		5	5		5
	Scarcity of space	3	3		3	
	Identification of user needs		1	1	1	
	Adaptability / transformability of production		5	5		
	Capital commitment of product storage		2			2
	High degree of user involvement		1		1	
	Ability to analyse large amounts of data			1		
	Generalization of production		2	2		2
	Value chain and stakeholder responsiveness		2		2	2
	<b>Relative influence of the subsystems</b>	<b>0%</b>	<b>38%</b>	<b>34%</b>	<b>19%</b>	<b>9%</b>
Addressing of local demands (prod. of individualized products)	Product variability		4	4		4
	Identification of user needs		4	4	4	
	Adaptability / transformability of production		5	5		
	Modularity of products		2	2		
	Adaptable product model			1		
	High degree of user involvement		2		2	
	Cooperative product development (user/prod.)		2	2	2	
	Ability to analyse large amounts of data			2		2
	Trend: Demand for individualised products		4		4	
Generalization of production		2	2		2	

The sum of the influences of one functional system on each main attribute of local production, considering the strength of the respective key influencing factors (long-term development perspective), was determined. This value was set in relation to the total amount of all influences of all considered functional systems for each main attribute to show the relative influence of the functional systems (see Table 3: Relative influence of the functional systems).

Based on these evaluations it is possible to compare the relevance of the functional systems' influences on the main attributes of local manufacturing.

## 4 Overview Over the Results

Figure 1 shows the relative influences of the functional systems on the main attributes of local manufacturing in comparison to each other. It becomes clear that the system-dependent influence varies for the different main attributes.



**Fig. 1.** Relative influence of subsystems on the main attributes of local manufacturing

### 4.1 Production at the Place of Need

The systems under consideration have a generally comparable influence on the dimension of **Production at the place of need**. However, the systems **Politics/Law** as well as **Economy** tend to have a stronger impact.

The **system Politics/Law** influences production on-site through political decisions and laws to develop local infrastructure and to ensure the availability of production areas (e.g. land use plans, price regulation measures). The **system Economy** significantly influences the economic valuation of the use of local land and the expansion of

local infrastructure for local manufacturing compared to other perspectives of use (housing, recreation, consumption), and thus the decisions regarding investments. The **system Production** influences **Production at the place of need** through its production concepts and technologies and their suitability for meeting the requirements of on-site production (cost-efficient manufacturing of small series, manufacturing technologies with little emission to promote acceptance by local residents, machines with little need for space, etc.). The further fulfilment of these requirements is also influenced by technological developments and new knowledge in **Engineering and Technology Sciences**. The influence of the **system Consumption** affects on-site production in particular through the demand for locally produced products.

#### 4.2 Utilisation of Local Resources

The utilisation of local resources is also particularly shaped by the influence of the **system Politics/Law** as well as the **system Economy**. The former, through its decisions and legislation, significantly impacts the availability and involvement of local human resources (e.g. legislation on immigration, education and training) and enterprises resources (e.g. import restrictions/tariffs, supply chain standards) as well as the suitability of the use and reuse of locally available raw materials, materials, products or components. Based on the legal framework as well as current and expected future market conditions (e.g. local and global availability of raw materials), the **system Economy** determines the prices and price expectations for local resources (labour and materials). These in turn form an important basis for investment decisions that can promote or restrict the availability and use of local resources (e.g. expansion of structures in the area of recycling or re-manufacturing). The **systems Production** as well as **Engineering and Technology Sciences** influence the use of local resources by creating opportunities for the use and reuse of locally available resources, e.g., through technology development, the implementation of CE design and production principles, and the introduction of appropriate processes for a sustainable, local circular economy. The **system Consumption** has a subordinate influence, which is due to the fact that the fulfilment of benefits is not adversely affected by the reuse of materials and components.

#### 4.3 Addressing of Local Demands

**Addressing of local demands** through local manufacturing is particularly dependent on the **systems Engineering and Technology Sciences** as well as **Production**. Corresponding research activities as well as the implementation of concepts for adaptable and customer-integrating production systems enable product manufacturing in a way that includes the customer in the value creation and identifies their individual requirements as well as it avoids warehousing through a demand-oriented and highly flexible production. The **system Consumption** shapes this dimension of local manufacturing in so far as its operations of satisfaction of needs depend on the utility dimensions present in the system, which need to be addressed. In the context of local manufacturing, it is relevant that these are not exclusively focused on the functionality and cost of the product (functional-economic value), but also represent benefits through participation in the value creation process (e.g. experience, DIY experience, responsibility) and the

addressing of an underlying understanding of value (e.g. ecological requirements) [14]. The **system Economy** creates the evaluation basis for investment decisions regarding research and design of production in the sense of the demand-oriented, highly flexible and space-minimizing production of goods.

#### 4.4 Structural Coupling of the Systems

In many cases, the central factors influencing local manufacturing are not affected exclusively by one system, but by different systems. From this overlap, the structural coupling of the systems and thus a mutual influence can be derived.

The coupling between the **system Politics/Law**, the **system Economy** and the **system Production** is of great importance. The **system Politics/Law** creates a framework for local manufacturing through political decisions and corresponding laws. On the one hand, this includes the creation of infrastructural prerequisites for the **system Production** for it to be able to establish production locally (suitable infrastructure, provision of land for production). On the other hand, this also involves regulations that determine the municipal requirements for production and thus its implementation (e.g. regulations regarding the return and reuse of products). In addition, the **system Politics/Law** also influences pricing through taxation requirements (e.g. CO<sub>2</sub> tax) and thus affects the **system Economy** and ultimately investment decisions for local manufacturing.

Another central coupling is the link between the **system Economy**, the **system Production** and the **system Engineering and Technology Sciences**. The system Economy has the methods for the economic evaluation of business models. Based on the economic evaluation of the value creation patterns of local manufacturing, the decision-making for investments ensues.

The **system Production**, the **system Engineering and Technology Sciences** and the **system Consumption** are coupled via the influencing factors for recording customer needs and for cooperative product development. The operation of consumption, as an act of prosuming, leads to participation in value creation and thus influences the successful implementation of operations in the **system Production**.

## 5 Summary and Discussion

This paper demonstrates that the establishment of local manufacturing requires operations in multiple different societal functional systems. Particularly important are the following functional systems: Politics, Law, Production, Engineering and Technology Sciences, Economy as well as Consumption. The systems are of varying importance to the different dimensions of local manufacturing and display structural couplings among each other. Based on the knowledge of the areas of influence of the systems and their couplings, recommendations for action must now be developed in a next step. These should focus the operations of the subsystems in such a way that they mutually promote the appropriate conditions for a positive development of the dimensions of local manufacturing while also eliminating any operational differences between the functional systems. The cross-system approach supports the development of recommendations for

action in so far as those relevant perspectives are not neglected and that the targeted promotion of local manufacturing is facilitated through the system operations of politics, economy, production, research and consumption.

The limitations of this paper lie within the fact that the influences of the individual systems are only represented in relation to each other. Although we were able to show what the central areas of influence of the functional systems on local manufacturing are and thus can provide a certain point of orientation, it is not possible to make a statement about how impactful the respective subsystems are in absolute terms.

**Acknowledgements.** This research is funded by dtcc.bw – Digitalization and Technology Research Center of the Bundeswehr [project: Production Next Door].

## References

1. Larsson, M.: Circular Business Models. Developing a Sustainable Future. Springer International Publishing, Cham (2018)
2. Srari, J.S. et al.: Distributed manufacturing. Scope, challenges and opportunities. *Int. J. Prod. Res.* **54** (2016)
3. Stahel, W.R.: The business angle of a circular economy. Higher competitiveness, higher resource security and material efficiency. In: Webster, K., Blériot, J., Johnson, C. (eds.) *A New Dynamic Effective Business in a Circular Economy*, pp. 45–60. Ellen MacArthur Foundation, Cowes, Isle of Wight (2013)
4. Krenz, P., Saubke, D., Stoltenberg, L., Markert, J.: Towards Smaller value creation cycles: key factors and their independencies for local manufacturing. In: 3rd Conference on Production Systems and Logistics (CPSL) (2022)
5. Lentjes, J., Hertwig, M., Zimmermann, N., Mahlau, L.-M.: Development Path for Industrial Enterprises Towards Urban Manufacturing. dtcc (2018)
6. Halverson, E.R., Sheridan, K.: The Maker Movement in Education. *Harvard Educ. Rev.* **84**(4), 495–504 (2014)
7. Matt, D.T., Rauch, E., Dallasega, P.: Trends towards distributed manufacturing systems and modern forms for their design. *Procedia CIRP* **33** (2015)
8. Moreno, M., Charnley, F.: Can re-distributed manufacturing and digital intelligence enable a regenerative economy? An integrative literature review. In: Setchi, R., et al. (eds.) *Sustainable Design And Manufacturing 2016. Smart Innovation, Systems and Technologies*, vol. 52, pp. 563–575. Springer, Cham (2016)
9. Vester, F.: *Ausfahrt Zukunft Supplement: Material zur Systemuntersuchung*, München (1991)
10. Krenz, P., Stoltenberg, L., Markert, J., Saubke, D., Redlich, T.: The phenomenon of local manufacturing: an attempt at a differentiation of distributed, re-distributed and urban manufacturing. In: Andersen, A.-L., et al. (eds.) *CARV/MCPC -2021. LNME*, pp. 1014–1022. Springer, Cham (2022). [https://doi.org/10.1007/978-3-030-90700-6\\_116](https://doi.org/10.1007/978-3-030-90700-6_116)
11. Luhmann, N.: *Soziale Systeme. Grundriß einer allgemeinen Theorie*, 1st edn. Suhrkamp, Frankfurt am Main (1984)
12. Kneer, G., Nassehi, A.: *Niklas Luhmanns Theorie sozialer Systeme. Eine Einführung*. UTB, vol. 1751. Fink, München (1993)
13. Luhmann, N.: *Die Gesellschaft der Gesellschaft*. Suhrkamp, Frankfurt am Main (1997)
14. Krenz, P.: *Formen der Wissensarbeit in einer vernetzten Wertschöpfung*, Dissertation, Helmut-Schmidt-Universität (2020)

**Open Access** This chapter is licensed under the terms of the Creative Commons Attribution 4.0 International License (<http://creativecommons.org/licenses/by/4.0/>), which permits use, sharing, adaptation, distribution and reproduction in any medium or format, as long as you give appropriate credit to the original author(s) and the source, provide a link to the Creative Commons license and indicate if changes were made.

The images or other third party material in this chapter are included in the chapter's Creative Commons license, unless indicated otherwise in a credit line to the material. If material is not included in the chapter's Creative Commons license and your intended use is not permitted by statutory regulation or exceeds the permitted use, you will need to obtain permission directly from the copyright holder.





# Role of Recycling Towards a Sustainable Business Model: A Perspective on Industrial Assets

Daniel Wörner<sup>(✉)</sup> and Thomas Friedli

Institute of Technology Management, University of St. Gallen, Dufourstrasse 40a,  
9000 St. Gallen, Switzerland  
daniel.woerner@unisg.ch

**Abstract.** Equipment manufacturers (EMs) exhibit unsustainable operating patterns in linear production models by depleting finite materials. In this context, future business environments in industrial markets shift fundamentally and form a new sustainability paradigm stimulated by key drivers, e.g., end customer behavior. Considering the market shift, this research explores an overview of prerequisites in the transition toward a sustainable business model in industrial markets. Prior research exhibited product life cycle extensions for industrial assets facilitated by the most common R-principles “reuse”, “remanufacture”, and “recycle”. Learning on previous research, recycling is instrumentalized for some materials, e.g., polyethylene terephthalate (PET). For industrial assets, manufactured products, such implementation efforts for EMs fall short. Investigating the shortage, this study (1) scrutinizes the role of recycling in the transition towards a sustainable business model, (2) identifies appropriate characteristics of industrial assets facilitating recycling, and (3) evaluates parameters to operationalize a recycling value chain (RVC). In a practice-based project, involving a Swiss-based equipment manufacturing company, mixed methods are applied. The results propose key drivers and characteristics facilitating recycling efforts of industrial assets and parameters fostering an RVC. Future research should increase the number of sample EMs and scrutinize the role of various RVC actors to exceed present limitations.

**Keywords:** industrial asset · parameter · recycling value chain · sustainable business model

## 1 Introduction

Sustainability topics are apparent across industries. Globally, business environments react to various key drivers such as end customer behavior, shareholder perception, regulation, and emerging technology in the change to a new paradigm [1–3]. Circular business models, a subset of sustainable business models, are a popular approach to facilitating a circular economy [4–6]. While the concept of sustainable business models roots back in the notion that businesses seek promotion for sustainability activities, currently it is often perceived as a source of achieving competitive advantage and reaching environmental awareness [7–9]. Geissdoerfer, Vladimirova and Evans [5] suggest a

holistic definition for a sustainable business model: “business models that incorporate pro-active multi-stakeholder management, the creation of monetary and non-monetary value for a broad range of stakeholders and hold a long-term perspective”. Mapping this general definition onto the manufacturing industry, the notion calls for a shift in which EMs should evolve their business model from a linear production approach to a more circular one [10, 11]. Manufacturing processes irreversibly exhaust finite materials and thus prevent organic regeneration. The Ellen McArthur Foundation [12] has aided in promoting the transformation of resources within a product life cycle. There is still a substantial gap for actionable insights, transferring theoretical elaboration to practical implementation. To address this issue, the research question is posed around the impact potential of activities along the recycling value chain (RVC) toward more sustainability in the manufacturing industry: “*What are recycling value chain parameters fostering industrial asset recycling taking an EM’s strategic and operational perspective?*”.

## 2 Recycling in the Manufacturing Industry

One way of handling finite resources more sustainably is the application of the so-called “R-principles” (RPs) [13]. These activities prolong the lifetime of industrial assets. At the end of the product life cycle, reaching End-of-Life (EoL), the RP “recycling” can be applied [14]. In literature no clear number and application of RPs can be found, e.g., Reike, Vermeulen and Witjes [15] introduce eight principle options while Wang, Kara and Hauschild [16] focus on three options. This study examines recycling, as this principle closes the loop by transforming asset materials into raw materials reused in production processes and slowing the exhaustion of finite resources [17, 18]. This piece of work focuses on the recycling of industrial assets, manufactured products, at the EoL because of its (1) positive impact reachable along the triple bottom line (economic, environmental, and social impact) and (2) vast neglect by EMs in the past [19]. Aside from literature research, this study follows a practice-based project perspective by gaining insights from a globally operating Swiss EM.

## 3 Research Method

The manufacturing industry is at the lever to accelerate sustainable production behavior and EoL management yet only a few companies are professionally using RPs in their business operations and transferring theory into practice. As the study considers qualitative and quantitative aspects, the data collection follows a mixed-methods approach by Eisenhardt [20]. Qualitative data is aggregated by conducting interviews with relevant actors in the value chain. The interview findings are contextualized according to the approach presented by Braun and Clarke [21]. Understanding a case-based business case and perceiving cross-industrial initiatives fosters the implementation potential and represent the quantitative data perspective. Iterative cross-checks and repetitive scrutiny of the present data information led to robust analyses. Information is clustered with analytical tools such as open-ended coding of interviews. Table 1 shows an overview of the data sources applied to the analyses.



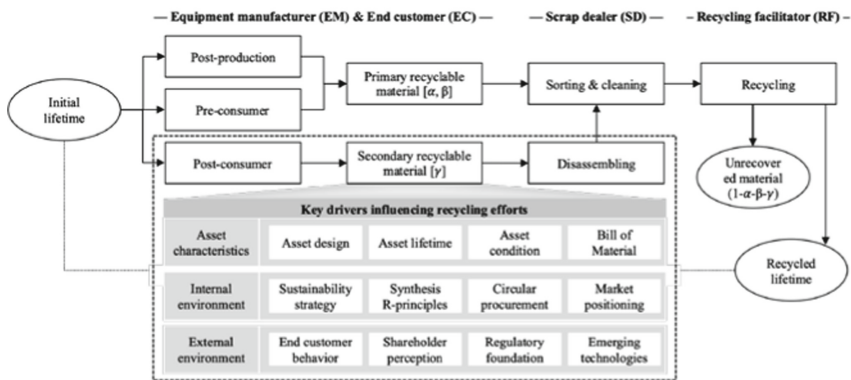
**Table 1.** Data sources

Data collection	Mixed-methods approach
Primary data sources	Semi-structured interviews (18) with actors of the RVC: equipment manufacturer, end customer, scrap dealer, recycling facilitator
Secondary data sources	Business case calculation based on company data not publicly available due to privacy restrictions; annual reports of equipment manufacturers; confidential company reports; confidential company archival material

### 4 Findings

Operationalization efforts of recycling are scattered and unstructured in industrial markets and rarely conducted by EMs. Scrutinizing this shortage of recycling exertion leads to key drivers and parameters revealing challenges and opportunities within the RVC.

Recycling defines mechanically and technologically advanced processing (e.g., shredding or melting) of primary and secondary recyclable materials. The former refers to post-production and pre-consumer by-products ( $\alpha$ ) and production scrap ( $\beta$ ), and the latter one to post-consumer industrial assets at the EoL ( $\gamma$ ) to circumvent the need to exhaust finite materials [22, 23]. Primary materials usually have little wear and tear. Hence are in a technically purer condition in contrast to secondary recyclable materials [24]. Figure 1 represents actors' jobs and processes as well as key drivers of recycling industrial assets in an RVC.

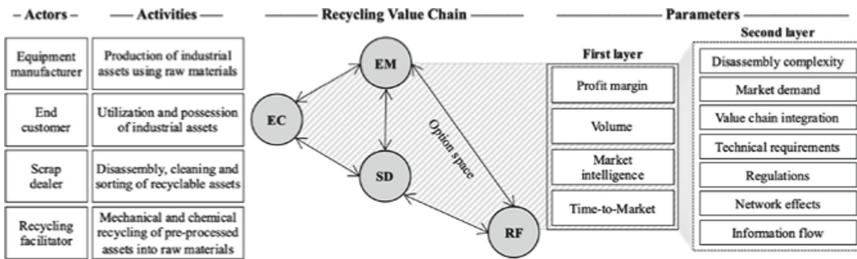


**Fig. 1.** Flow diagram of processes within the RVC and key drivers facilitating recycling efforts of industrial assets (dashed box).

Primary data sources revealed characteristics clustered as “asset design”, “asset lifetime”, “asset condition” and “Bill of Material” (BoM), influential for the recycling of secondary recyclable material. Industrial assets should follow a design that decreases the assembly complexity and improves the time-efficiency of disassembly for jobs performed by the EM and SD [26]. For instance, industrial assets with lots of mechanically

connected components (e.g., use of screws to attach parts) are easier to detach and pre-process than materially connected ones (e.g., components glued to each other). The asset’s lifetime largely depends on the asset’s operation time. It was found that an asset’s EoL is reached significantly faster at high operation. Heavy usage along with wear and tear ultimately show an effect on the asset’s condition, which often results in reconditioning practices such as repair and maintenance. Finally, the BoM decides on the valuation and monetization potential of materials in downstream activities within the RVC. Recycling efforts are influenced by external drivers, which are generally applicable across industries and internal drivers that represent microeconomic factors for the investigated case study and are more specific to the machine tool industry. For instance, “sustainability strategy” reflects a need for companies to align with strategic and operational goals internally and externally toward sustainability. “End customer behavior” reflects the increasing request for actions with an impact along the triple bottom line.

Primary and secondary data yielded parameters that influence the recycling efforts of industrial assets within the RVC (cf. Figure 2). The interrelation between actors enables vertical and horizontal integration. For instance, EMs could collaborate with competitors to standardize the design of industrial assets for further recycling steps, or EMs could pre-disassemble recyclable materials for the SDs. Primary data analysis reveals first layer parameters, which critically influence the EM’s operational and strategic efforts. Second layer parameters affect the former ones and contain more generally applicable aspects, such as market demand or regulations.



**Fig. 2.** The recycling value chain of industrial assets displays four interrelated actors and the integration potential from the EM’s perspective (arrows).

A first layer parameter, “profit margin”, represents the potential to claim profits moving along the actors in the RVC. The profit margin on material prices complies against commodity prices. Fluctuations in commodity prices would affect the profit margin and potentially increase the popularity of closed-loop material treatment. Recycling achieves at most value retention and usually value reduction, the reintroduction price of recycled materials is generally below their new price. Some recyclers specialize in refining recycled assets by adding other materials to suit the production purpose of certain industries (e.g., durable and flexible metal alloys used in aerospace). Recyclable industrial assets are traded linearly down the value chain. Information density and amount of industrial assets recyclable determine the value of materials for the SD and RF. For the EM, the margin potential is dwindling, because the customer’s perceived value of

recycling services is minor, and the price elasticity is high, thus the price has to be competitive. At the same time, the conditions for selling recyclable assets to the SD are unfavorable. The EM can counteract by having clarity about the BoM as well as material knowledge. Installed bases of industrial assets at the EoL are diversely scattered across multifarious production plants and information is unstructured. Asset BoMs suitable for recycling efforts hence are challenging to assess. Market prices correlate positively with the density of asset material information. Given stronger economic incentives, e.g., tax relief or material prices, recycling services could be offered to the end customers at an improved financial and ecological incentive, e.g., CO<sub>2</sub> certificates or eco-labeling. Eventually, the RVC would benefit from greater value due to Co-creation and a positive environmental impact by closing the loop more efficiently.

“Volume” impacts the recycling feasibility and viability. Related to the profit potential, aggregating a sufficient volume of recyclable industrial assets enables Economies-of-Scale (EoS). The larger the weight of collected materials and the higher the level of material information, the greater a positive price influence. To be economically profitable, a certain collected volume of assets at the EoL is required, e.g., SDs have thresholds where the price paid per weight jumps. Especially, industrial assets, which are bulky and heavy, and together with their typical low residual value, barely cover the transportation costs given a comparatively long product life cycle. This leads to industrial assets being handled rather locally. The hurdle is prevalent due to the immobile locality of SDs and recyclers’ facilities. Simultaneously, it sheds light on an opportunity for EMs. EMs can integrate forward, assuming they can find a way to logistically control the flow of recyclable industrial assets. They would gain negotiation power on the monetization of industrial assets if sold to SDs or RFs. One possible scenario is the use of prevalent EM-owned facilities to mid-store recyclable assets until a certain threshold is reached. Having multiple localities enables shorter and more efficient transport routes leading to competitive advantages for EMs with several distributed facilities. Cross-border routes must consider taxation policies and legal limitations to transport scrap. Upon this operating model, a mobile solution consisting of equipped truck units may perform SD jobs. Reducing idle time leads to rapidly reaching the collection capacity, eventually benefiting the profit margin. Such transparency also leverages the EM’s negotiation power and might result in favorable contracting.

This goes along with the parameter “market intelligence”, which indicates the EM’s knowledge available about their ECs’ installed bases. Intertwined with the previous parameter, the data information received through the EC can stack the information density, respectively. Communication flows between actors are usually bilateral via outdated communication media such as fax or telephone, indicating that Industry 4.0 technologies’ potential is not utilized. It is challenging to find industrial assets at the EoL with geographically scattered assets. One mechanism that leads to this situation is shielding insights from competitors. A second mechanism is the end customers’ ignorance with the lack of recycling options. Finally, a third mechanism is the absence of an adequate incentive system, which links back to the aforementioned margin squeeze. To date, there is no uniform solution to close this gap. A promising approach would be to set up a database platform that collects information about the industrial assets’ lifetime at the EM’s installed base, condition, and geographical location. Such a platform would

increase knowledge about asset locality while addressing the inherent volume dependency of SDs and RFs. Certain companies exhibit strategic intentions toward data and asset management in B2B (e.g., service model “Nuron” from Hilti Group [25]). Gaining access to the required data is a challenge. In the past, ECs and EMs were not used to share data, but an aligned value proposition might initiate a change. Primary data samples reveal a widely scattered EC sentiment regarding the willingness to share information, while some proponents argued for a transition toward more sustainability in the industry, others do not disclose any data.

Finally, timing the introduction of recycling activities is crucial to pick up the momentum of sustainability drivers. The “Time-to-Market” (TtM) defines the speed at which an initiative is launched and introduced to the market. Reflecting the EM’s embedment in the value chain, integrating toward the EC can have a faster TtM than toward the RF. Equipment manufacturers currently are active with locally implemented recycling activities that mostly focus on primary material. Interviews with organizations in the machine tool industry exhibited an interest among competitors to co-create value, e.g., developing recycling standards. Focusing on market competitiveness, a prompt TtM might unfold first-mover advantages and chances to steer market practices e.g., influencing the price behavior and expectation of customers.

## 5 Conclusion

Recycling builds on an RVC and the interdependence among its actors, yielding a promising approach in the transition toward sustainable business models. Nonetheless, current recycling efforts are inefficient. Our study shed light on the prerequisites to foster and facilitate an efficient RVC taking the EM’s strategic and operational perspective. Based on our case study, we identified key characteristics of industrial assets and parameters influencing the RVC and uncovered the fundamentals of fostering recycling. Among the RPs, recycling holistically is a difficult step to implement. Primary data exhibits progressive initiatives and incentivization from international committees and country initiatives (e.g., cross-border transportation of recyclable materials). For example, recent initiatives such as the “European Green Deal” (2019), the “Circular Economy Action Plan” (2020), or the “Sustainable products initiative” (2022) of the EU Commission promote a more sustainable industry [27]. Cross-industries are introducing material passports, which precisely record the BoM and material composition of industrial assets. For instance, within the maritime industry, the shipbuilder Maersk introduced a “cradle-2-cradle passport” to facilitate recycling [28].

This work’s data collection follows a single case study approach that focused on one company’s embedment in the RVC. The boundary conditions and limitations of our single case study need to be considered when internalizing and generalizing our findings. First, we studied a leading firm with a strong competitive position in the machine tool industry. And second, we gathered our primary and secondary data within Europe, predominantly in Switzerland, Germany, and Italy. We propose further investigation with a greater number of sample cases to enhance the understanding of the suggested parameters. Our research is initially centering on an EM. The scope of actors in the RVC should be extended by exploring intermediaries such as secondhand asset dealers and scrutinizing

the role of the actors. Finally, recycling activities can be supported by Industry 4.0 technologies (e.g., digital twins, Industrial Internet of Things, big data analytics, etc.) to overcome introduced challenges in the current RVC.

## References

1. Vermunt, D., Negro, S., Verweij, P., Kuppens, D., Hekkert, M.: Exploring barriers to implementing different circular business models. *J. Clean. Prod.* **222**, 891–902 (2019)
2. De Jesus, A., Mendonça, S.: Lost in transition? Drivers and barriers in the eco-innovation road to the circular economy. *Ecol. Econ.* **145**, 75–89 (2018)
3. Bjørnset, M.M., Skaar, C., Fet, A.M., Schulte, K.Ø.: Circular economy in manufacturing companies: a review of case study literature. *J. Clean. Prod.* **294**, 126268 (2021)
4. Lieder, M., Rashid, A.: Towards circular economy implementation: a comprehensive review in context of manufacturing industry. *J. Clean. Prod.* **115**, 36–51 (2016)
5. Geissdoerfer, M., Vladimirova, D., Evans, S.: Sustainable business model innovation: A review. *J. Clean. Prod.* **198**, 401–416 (2018)
6. Lüdeke-Freund, F., Gold, S., Bocken, N.M.: A review and typology of circular economy business model patterns. *J. Ind. Ecol.* **23**(1), 36–61 (2019)
7. Bocken, N.M., Short, S.W., Rana, P., Evans, S.: A literature and practice review to develop sustainable business model archetypes. *J. Clean. Prod.* **65**, 42–56 (2014)
8. Morioka, S.N., Bolis, I., Evans, S., Carvalho, M.M.: Transforming sustainability challenges into competitive advantage: multiple case studies kaleidoscope converging into sustainable business models. *J. Clean. Prod.* **167**, 723–738 (2017)
9. Nosratabadi, S., Mosavi, A., Shamshirband, S., Kazimieras Zavadskas, E., Rakotonirainy, A., Chau, K.W.: Sustainable business models: a review. *Sustainability* **11**(6), 1663 (2019)
10. Gusmerotti, N.M., Testa, F., Corsini, F., Pretner, G., Iraldo, F.: Drivers and approaches to the circular economy in manufacturing firms. *J. Clean. Prod.* **230**, 314–327 (2019)
11. Michelini, G., Moraes, R.N., Cunha, R.N., Costa, J.M., Ometto, A.R.: From linear to circular economy: PSS conducting the transition. *Procedia CIRP* **64**, 2–6 (2017)
12. MacArthur, E.: Towards the circular economy. *J. Ind. Ecol.* **2**(1), 23–44 (2013)
13. Bag, S., Gupta, S., Kumar, S.: Industry 4.0 adoption and 10R advance manufacturing capabilities for sustainable development. *Int. J. Prod. Econ.* **231**, 107844 (2021)
14. Kirchherr, J., Reike, D., Hekkert, M.: Conceptualizing the circular economy: an analysis of 114 definitions. *Resour. Conserv. Recycl.* **127**, 221–232 (2017)
15. Reike, D., Vermeulen, W.J., Witjes, S.: The circular economy: new or refurbished as CE 3.0?—exploring controversies in the conceptualization of the circular economy through a focus on history and resource value retention options. *Resour. Conserv. Recycl.* **135**, 246–264 (2018)
16. Wang, P., Kara, S., Hauschild, M.Z.: Role of manufacturing towards achieving circular economy: the steel case. *CIRP Ann.* **67**(1), 21–24 (2018)
17. Achterberg, E., Hinfelaar, J., Bocken, N.: Master circular business with the value hill. September 2016 [Online]. [https://assets.website-files.com/5d26d80e8836af2d12ed1269/5dea74fe88e8a5c63e2c7121\\_finance-white-paper-20160923.pdf](https://assets.website-files.com/5d26d80e8836af2d12ed1269/5dea74fe88e8a5c63e2c7121_finance-white-paper-20160923.pdf). Accessed: 16 Apr 2022
18. Delchet-Cochet, K.: *Circular Economy: From Waste Reduction to Value Creation*. John Wiley & Sons, New York (2020)
19. Ahmad, S., Wong, K.Y., Rajoo, S.: Sustainability indicators for manufacturing sectors: a literature survey and maturity analysis from the triple-bottom line perspective. *J. Manuf. Technol. Manag.* **30**(2), 312–334 (2018)
20. Eisenhardt, K.M.: Building theories from case study research. *Acad. Manag. Rev.* **14**(4), 532–550 (1989)

21. Braun, V., Clarke, V.: Using thematic analysis in psychology. *Qual. Res. Psychol.* **3**(2), 77–101 (2006)
22. Alamerew, Y.A., Brissaud, D.: Circular economy assessment tool for end of life product recovery strategies. *J. Remanufact.* **9**(3), 169–185 (2019)
23. Daniyan, I., Mpofu, K., Ramatsetse, B., Gupta, M.: Review of life cycle models for enhancing machine tools sustainability: lessons, trends and future directions. *HELIYON* **7**(4) (2021). <https://doi.org/10.1016/j.heliyon.2021.e06790>
24. Nicholson, A.L., Olivetti, E.A., Gregory, J.R., Field, F.R., Kirchain, R.E.: End-of-life LCA allocation methods: open loop recycling impacts on robustness of material selection decisions. In: 2009 IEEE International Symposium on Sustainable Systems and Technology, pp. 1–6 (2009)
25. Nuron – The completely new cordless platform with built-in connectivity. Media Releases Ad Hoc News 12 January 2022. <https://www.hilti.group/content/hilti/CP/XX/en/company/media-relations/media-releases/Nuron.html>. Accessed 13 May 2022
26. Bocken, N.M., De Pauw, I., Bakker, C., Van Der Grinten, B.: Product design and business model strategies for a circular economy. *J. Ind. Prod. Eng.* **33**(5), 308–320 (2016)
27. European Commission: Communication from the Commission to the European Parliament, the Council, the European Economic and Social Committee and the Committee of the Regions – A new Circular Economy Action Plan – For a cleaner and more competitive Europe.” 11 March 2020. [Online]. <https://eur-lex.europa.eu/legal-content/EN/TXT/?qid=1583933814386&uri=COM:2020:98:FIN>. Accessed 12 Apr 2022
28. Jensen, J.P., Remmen, A.: Enabling circular economy through product stewardship. *Procedia Manufacturing* **8**, 377–384 (2017)




**Open Access** This chapter is licensed under the terms of the Creative Commons Attribution 4.0 International License (<http://creativecommons.org/licenses/by/4.0/>), which permits use, sharing, adaptation, distribution and reproduction in any medium or format, as long as you give appropriate credit to the original author(s) and the source, provide a link to the Creative Commons license and indicate if changes were made.

The images or other third party material in this chapter are included in the chapter’s Creative Commons license, unless indicated otherwise in a credit line to the material. If material is not included in the chapter’s Creative Commons license and your intended use is not permitted by statutory regulation or exceeds the permitted use, you will need to obtain permission directly from the copyright holder.





# Consumer Perceptions of the Circular Business Model: A Case of Leasing Strollers

Farazee M. A. Asif<sup>(✉)</sup> , Niloufar Salehi , and Michael Lieder 

KTH Royal Institute of Technology, 10044 Stockholm, Sweden  
aasi@kth.se

**Abstract.** Circular Economy (CE) promotes trading functions of a product as a service instead of selling the product in conventional ways. For a product like a baby stroller, the function means ensuring mobility with infants without needing to own a stroller. This approach of acquiring functions only when needed opens up the possibility to share the same products with multiple users. For a manufacturer that has built its business on a conventional sales model over the decades, this shift may be too radical. Therefore, for the manufacturers, it is important to understand consumer perceptions of the service-oriented business model before entering this unknown territory. To develop a thorough understanding of consumer perceptions of leasing a stroller instead of buying one, a survey among 200 parents in Stockholm is conducted. The survey brings out quantitative results such as 39% of respondents are open to leasing and identifies key influencing factors such as convenience and environmental image that play a key role for the remaining 61% of respondents to choose leasing. This research concludes that a large number of consumers are open to leasing if a high level of service and environmentally sustainable strollers are offered at a competitive price.

**Keywords:** Circular Economy · Business model · Leasing · Service-oriented · Consumer perceptions

## 1 Introduction

The Circular Economy (CE) can yield cost savings and can result in significant environmental benefits [1]. Since the CE has the potential to create economic benefits for the manufacturing industry in which environmental sustainability is embedded, many companies are considering implementing Circular Manufacturing Systems (CMS), where the products and business models are designed intentionally to close the loop of products and/or components [2]. To succeed with the CMS approach the Original Equipment Manufacturers (OEM) need to retain the ownership of the products and adopt innovative business models that promote trading functions of a product as a service instead of selling [3]. This approach of acquiring functions only when needed opens up the possibility to share the same products with multiple users. For an OEM that has built its business on a conventional sales model over the decades, this shift may be too radical. Therefore, for the manufacturers, it is important to understand consumers' perceptions of the

service-oriented business model such as leasing strollers in this case before entering this unknown territory. This paper presents a thorough understanding of consumers' perceptions of leasing a stroller instead of buying one. For a product like a baby stroller, the service/function means ensuring mobility with infants without needing to own a stroller. This case study is interesting from a product-service system perspective as it represents a high-priced product that has a short use time and high recovery value at the end of its lifecycle.

## 2 Research Review

Service-oriented business models are one of the essential instruments to implement CMS. However, deploying service-oriented business models requires radical changes in the firm's business operations [4]; where consumer perceptions to adopt these business models is an important element to consider. Camacho-Otero et al. (2018) claimed that personal characteristics drive consumption. For example, consumers concerned about social status prefer branded products and some consumers choose used products to gain status by distinguishing themselves from others [6].

In general, a lack of knowledge of the possible values and risks of service-oriented business models is an obstacle in putting service-oriented business models into practice [7–9]. Information about the total cost of ownership, quality of products, environmental benefits, and additional services (i.e. whether service and maintenance of products are included or not) is crucial for consumers' decision making [5, 7–9]. Schallehn et al. (2019) and Camacho-Otero et al. (2018) highlighted that positive experiences from interaction with the service provider are important in embracing and promoting service-oriented business models. The positive experience is a result of ensuring economic value, uniqueness, environmental friendliness, and convenience. Singh and Giacosa, (2019) identified that Individual, Social, and Cultural aspects influence acceptance of the circular business model. Cultural aspects, such as negative perceptions about sharing, accepting used products and resistance to change play a major role in the success of a service-oriented business [5, 8–10].

Mont et al. (2006) argue that the existence of large second-hand markets for baby strollers is a sign of the positive attitude of young parents to buy used products. Leasing strollers provide the flexibility of adjusting the needs under the service contract and make premium products affordable. Moreover, through this business model, consumers do not need to store the strollers or spend time selling them. The environmental benefits of leasing baby strollers lie in prolonging the product use phase, reducing the number of produced products, and improving the end of life strategies [11]. Van Weelden et al. (2016) concluded that lack of awareness, unclear definition of refurbishment, and perceived risks affect the acceptance of refurbished mobile phones. Poppelaars et al. (2018) concluded that consumers reject access-based smartphone services due to a lack of awareness about the smartphone access service, poor image of the service provider, lack of ownership, and sustainability concerns. D'Agostin et al. (2020) and Day et al. (2020) respectively concluded that environmental concerns, as well as a healthy lifestyle and the monetary perspective of the service-oriented business models, are the main drivers of adopting it. They also pointed out that additional options could be considered as convenience or burden. For some consumers, ownership of the products is more important [8,



15] and the lack of ownership can often be regarded as being dependent on the service provider [7, 15].

### 3 Research Method

This research is conducted by applying a research method that combines both survey research and research review. Survey research is applied for acquiring information about consumers' opinions and attitudes toward leasing a stroller. The review process is used for exploration to gain insights into relevant research. The findings of this review process are used to strengthen the survey results.

The research started with the main assumption that there are three segments of consumers a) *Consumers who will always lease a stroller*, b) *Consumers who may or may not lease a stroller*, and c) *Consumers who will never lease a stroller*. To limit the scope, convenience and environmental benefits are assumed to be the additional value propositions. Furthermore, the research also assumed that consumers accept used strollers that are restored to new-like conditions if they are environmentally sustainable and maintain hygiene.

To conduct the survey, two sets of questionnaires are designed as the base for face-to-face interviews. One set is designed for the parents who already own a stroller and the other set is for parents expecting a child and considering acquiring a stroller. The survey is designed mainly with closed-ended questions with two open-ended questions to acquire a wider understanding of what motivates or discourages a consumer to opt for the leasing option [17]. The questions are organized in a logical order creating a flow chart structure where a respondent needs to respond either yes or no to each question. Depending on the responses, different respondents follow different flows of questions until the survey ends. Due to this relatively complex structure of the survey and to ensure a high response rate the survey was only conducted in presence of a data collector. A survey among 200 parents in Stockholm was conducted and 181 respondents completed the questionnaire. Of these 181 respondents, 100 are parents having a child who already owns a stroller and the remaining 81 are parents who are expecting a child and considering acquiring a stroller for their future child.

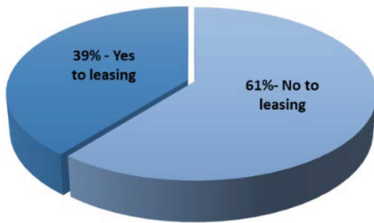
## 4 Results

As Fig. 1 shows, 39% of the respondents (a total of 181 respondents) have shown positive interest to lease a stroller, when no further information about additional values or challenges with the leasing offer was communicated. However, the respondents responded differently when these additional values and challenges with the leasing offer were exposed, which is presented in the following sub-sections.

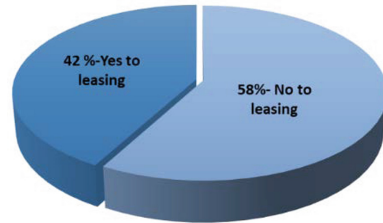
### 4.1 Response of the Parents Having a Child Who Already Own a Stroller

In case of parents having a child who already owns a stroller of a specific brand, 42% (42 respondents out of 100) respondents have shown positive interest to lease a stroller as

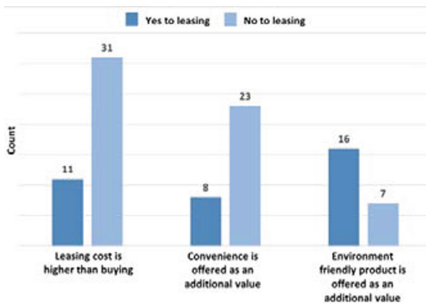
shown in Fig. 2. Out of these 42 respondents, 31 responded negatively to the leasing offer if the total cost of ownership during the leasing period is higher than buying a stroller, as presented in Fig. 3. However, 8 respondents out of 31 remained positive to leasing offer when convenience is offered as an added value and an additional 16 respondents out of the remaining 23 critical respondents turned positive to leasing offer for a product that is environment friendly. Ultimately, 7 respondents remained critical to the higher cost of leasing, who consider the cost of leasing is more important than convenience or an environment-friendly product. In this group, 35 respondents remained positive (adding all positive responses from Fig. 3) and 7 remained negative to leasing offer respectively.



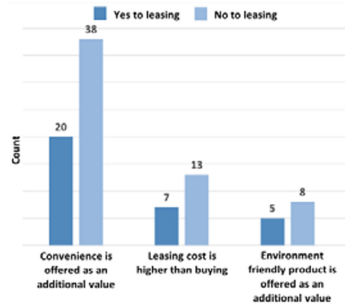
**Fig. 1.** The distribution of consumers willing and not willing to lease a stroller.



**Fig. 2.** The ratio of respondents (parents having a child) willing and not willing to lease a stroller



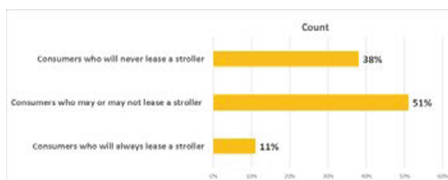
**Fig. 3.** The number of respondents to the added values, who initially showed positive interest in the leasing offer



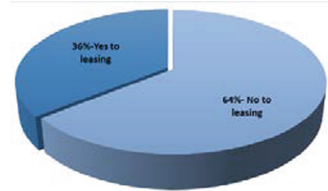
**Fig. 4.** The number of the respondents to the added values who initially shown negative interest.

The 58 respondents who initially remained negative to the leasing offer responded as shown in Fig. 4. Out of these 58, 20 respondents became positive to the leasing offer when convenience is offered as an additional value, but only 7 out of 20 remained positive when the total cost of ownership during the leasing period said to be higher than the cost of buying the stroller. However, 5 additional respondents out of 13 remaining critical ones became inclined to the leasing offer when the offer included an environment-friendly product. In total, 12 respondents in this group turned positive to the leasing offer when convenience and an environment-friendly product are offered and 8 respondents remained critical of the higher cost of leasing resulting in 46 respondents out of 58, i.e., 38 in the beginning and 8 considering all other motivating factors, being negative to the leasing offer.

To summarise the results of the responses received from the parents having a child and already owning a stroller, 47 (i.e., 35 out of 42 and 12 out of 58) (47%) respondents out of 100 are willing to accept a leasing offer when convenience and an environment-friendly product is made part of the value proposition. 53 respondents (53%) are not willing to accept leasing as the offer in this particular case. To summarise (as shown in Fig. 5), 11% are in favour of leasing (11 out of 100 respondents were positive in all conditions, see Fig. 3), 38% are not in favour of leasing (38 out of 100 respondents were negative even if they receive more convenience, see Fig. 4) and the largest group, i.e. 51% is in favour of evaluating the leasing offer in terms of price, convenience, and environmental image. The survey also revealed that 71% (30 out of 42 respondents) of the respondents who are positive about leasing are also open to leasing a used product that is remanufactured or refurbished.



**Fig. 5.** The distribution of the consumers in the three categories; consumers who will always lease, may or may not lease, and never lease.



**Fig. 6.** The ratio of respondents (parents expecting a child) willing and not willing to lease a stroller

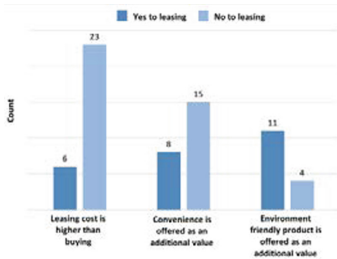
## 4.2 Response of the Parents Expecting a Child Who Do not Own a Stroller

In the case of parents expecting a child, 36% (29 respondents out of 81) respondents have shown positive interest to lease a stroller as shown in Fig. 6. Out of these 29 respondents, 23 responded negatively to the leasing offer if the total cost of ownership during the leasing period is higher than buying a stroller. However, as shown in Fig. 7, 8 respondents out of 23 remained positive about leasing offer when convenience is offered as an added value and an additional 11 respondents out of the remaining 15 critical respondents turned positive to leasing offer for a product that is environment-friendly. Ultimately, 4 respondents remained critical to the higher cost of leasing, who see the cost of leasing is more important than convenience or an environment-friendly product. In this group, 25 respondents remained positive and 4 remained negative to leasing offer respectively.

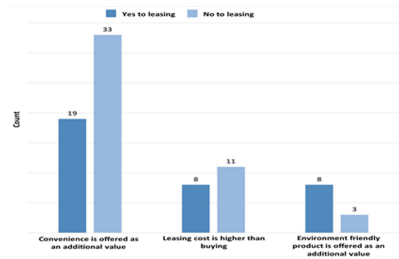
The 52 respondents who initially remained negative to the leasing offer responded as shown in Fig. 8, out of these 52, 19 respondents became positive to the leasing offer when convenience is offered as an additional value, but only 8 out of 19 remained positive when the total cost of ownership during the leasing period said to be higher than the cost of buying the stroller. However, 8 additional respondents out of 11 remaining critical ones became inclined to leasing when the leasing offer included an environment-friendly product. In total, 16 respondents in this group turned positive to the leasing offer when convenience and an environment-friendly product are offered as the additional values and

3 respondents remained critical of the higher cost of leasing resulting in 36 respondents, i.e., 33 in the beginning and 3 considering all other factors, being negative to the leasing offer.

To summarise the result of the responses received from the parents expecting a child who do not own a stroller, 41 (i.e., 25 out of 29 and 16 out of 52) (51%) respondents out of 81 are willing to accept leasing.



**Fig. 7.** The number of the respondents to the added values, who initially shown positive interest in the lease offer



**Fig. 8.** The number of respondents to the added values who initially showed negative interest in the leasing offer.

offer when convenience and an environment-friendly product is made part of the value proposition. Furthermore, this group of consumers is willing to pay extra for this additional value proposition. 40 (49%) respondents do not consider leasing as an offer of their choice, of which 7 (i.e., 4 out of 23, see Fig. 7, and 3 out of 19, see Fig. 8) refused to lease if the cost of ownership of leasing is higher than buying a stroller. To summarise, 7% is in favour of leasing (6 out of 81 respondents were positive in all conditions, see Fig. 7), 41% are not in favour of leasing (33 out of 81 respondents were negative even if they receive more convenience, see Fig. 8) and the largest group, i.e. 52% is in favour of evaluating the leasing offer in terms of price, convenience, and environmental image. The survey also revealed that 79% (23 out of 29 respondents) of the respondents who are positive to leasing are also open to lease a used product that is remanufactured or refurbished.

## 5 Discussion and Conclusions

In this paper, consumers' perceptions of leasing baby strollers have been studied. This research quantifies the distribution of the consumers in Sweden in three categories, naming consumers who will always lease, consumers who may or may not lease, and consumers who will never lease a stroller based on the survey research. This research, as well as previous studies, confirms that competitive price is one of the important attributes in deciding whether to go for leasing or not. This research further confirms that convenience and environmental-friendly products increase consumers' tendency to lease these products.

The survey results in both cases (parents own a stroller and parents do not own a stroller) show that there is a large number of consumers (38% and 41% respectively) who are not willing to lease a stroller. The three key reasons for not leasing or leasing a stroller are listed in Table 1. This also confirms that environmental aspects are not key

decision-making factors but can create significant value. There is a small segment (11% and 7%) of consumers willing to go for leasing unconditionally. For this segment, the possibility to pay monthly, return the stroller after use, and the possibility to change the stroller are the three key reasons (Table 1) for leasing.

**Table 1.** Three key reasons for not leasing or leasing a stroller are identified through an open-ended question in the survey

Key reasons for not leasing	Key reasons for leasing
The resale value of the stroller	Monthly payment option
Some consumers prefer ownership	No need to store the stroller after use and as it will be taken back
Possibility to use the same stroller for the 2nd child	Possibility to change the stroller as the needs change

The largest segment (i.e. 51% and 52% respectively) is the group of consumers that makes a conscious decision by comparing existing offers. For this segment, the total cost of ownership is the most important factor in decision-making. However, a large portion of this segment is willing to pay extra for convenience and they highly value environmental-friendly products. Respectively about 70% (who own a stroller) and 83% (who do not own a stroller) of this segment are willing to go for leasing if the convenience and an environmental-friendly product is part of the value propositions. This finding also confirms that the assumption, that “consumers in Sweden value convenience and an environmentally sustainable product as part of the leasing offer” mentioned at the beginning of this paper is true. Furthermore, this study concludes that whether a consumer owns a stroller or plans to acquire a stroller does not have any significant influence on the perceptions about leasing a stroller instead of buying. All consumers in both categories perceive the leasing offer and its cost, convenience, and environmental-friendly products similarly.

## References

1. Ellen MacArthur Foundation. Towards the circular economy: opportunities for the consumer goods sector (2013). <https://www.emerald.com/insight/content/doi/10.1108/IJMPB-06-2021-0142/full/pdf?title=system-dynamics-approach-of-knowledge-transfer-from-projects-to-the-project-based-organization>
2. Asif, F. M. A.: Circular Manufacturing Systems: A Development Framework with Analysis Methods and Tools for Implementation. KTH Royal Institute of Technology, Stockholm (2017)
3. Rashid, A., Asif, F. M. A., Krajnik, P., Nicolescu, C.M.: Resource conservative manufacturing: an essential change in business and technology paradigm for sustainable manufacturing. *J. Clean. Prod.* **57** (2013). <https://doi.org/10.1016/j.jclepro.2013.06.012>
4. Rashid, A., Roci, M., Asif, F.M.A.: Circular manufacturing systems. In: Brandão, M., Lazarevic, D., Finnveden, G. (eds.) *Handbook of the Circular Economy*, Edward Elgar Publishing (2020)

5. Camacho-Otero, J., Boks, C., Pettersen, I.N.: Consumption in the circular economy: a literature review. *Sustain.* **10**(8) (2018). <https://doi.org/10.3390/su10082758>
6. Schallehn, H., Seuring, S., Strähle, J., Freise, M.: Customer experience creation for after-use products: a product–service systems-based review. *J. Clean. Prod.* **210**, 929–944 (2019). <https://doi.org/10.1016/j.jclepro.2018.10.292>
7. Day, S., Godsell, J., Masi, D., Zhang, W.: Predicting consumer adoption of branded subscription services: a prospect theory perspective. *Bus. Strateg. Environ.* **29**(3), 1310–1330 (2020). <https://doi.org/10.1002/bse.2435>
8. Vezzoli, C., Ceschin, F., Diehl, J.C., Kohtala, C.: New design challenges to widely implement ‘sustainable product-service systems.’ *J. Clean. Prod.* **97**, 1–12 (2015). <https://doi.org/10.1016/j.jclepro.2015.02.061>
9. Moro, S.R., Imhof, A.C., Fettermann, D.C., Cauchick-Miguel, P.A.: Barriers to bicycle sharing systems implementation: analysis of two unsuccessful PSS. *Procedia CIRP* **73**, 191–196 (2018). <https://doi.org/10.1016/j.procir.2018.03.312>
10. Singh, P., Giacosa, E.: Cognitive biases of consumers as barriers in transition towards circular economy. *Manag. Decis.* **57**(4), 921–936 (2019). <https://doi.org/10.1108/MD-08-2018-0951>
11. Mont, O., Dalhammar, C., Jacobsson, N.: A new business model for baby prams based on leasing and product remanufacturing. *J. Clean. Prod.* **14**(17), 1509–1518 (2006). <https://doi.org/10.1016/j.jclepro.2006.01.024>
12. Van Weelden, E., Mugge, R., Bakker, C.: Paving the way towards circular consumption: exploring consumer acceptance of refurbished mobile phones in the Dutch market. *J. Clean. Prod.* **113**, 743–754 (2016)
13. Poppelaars, F., Bakker, C., van Engelen, F.: Does access trump ownership? Exploring consumer acceptance of access-based consumption in the case of smartphones. *Sustain* **10**(7) (2018). <https://doi.org/10.3390/su10072133>
14. D’Agostin, A., de Medeiros, J.F., Vidor, G., Zulpo, M., Moretto, C.F.: Drivers and barriers for the adoption of use-oriented product-service systems: a study with young consumers in medium and small cities. *Sustain. Prod. Consum.* **21**, 92–103 (2020). <https://doi.org/10.1016/j.spc.2019.11.002>
15. Catulli, M., Cook, M., Potter, S.: Consuming use orientated product service systems: A consumer culture theory perspective. *J. Clean. Prod.* **141**, 1186–1193 (2017). <https://doi.org/10.1016/j.jclepro.2016.09.187>
16. Punch, K.F.: *Survey research : the basics*. Sage Publ.(2003), [Online]. <http://dx.doi.org.libezproxy.open.ac.uk/https://doi.org/10.4135/9781849209984>
17. Salant, P., Dillman, D.A.: *How to Conduct Your Own Survey*. John Wiley & Sons, New York (1994)

**Open Access** This chapter is licensed under the terms of the Creative Commons Attribution 4.0 International License (<http://creativecommons.org/licenses/by/4.0/>), which permits use, sharing, adaptation, distribution and reproduction in any medium or format, as long as you give appropriate credit to the original author(s) and the source, provide a link to the Creative Commons license and indicate if changes were made.

The images or other third party material in this chapter are included in the chapter’s Creative Commons license, unless indicated otherwise in a credit line to the material. If material is not included in the chapter’s Creative Commons license and your intended use is not permitted by statutory regulation or exceeds the permitted use, you will need to obtain permission directly from the copyright holder.





# Guideline for Identifying Required Data Granularity for Deriving Improvements to the Environmental Impact of Production

Michel Kaufmann<sup>1</sup>, Henry Ekwaro-Osire<sup>1,2(✉)</sup>, and Klaus-Dieter Thoben<sup>1,2</sup>

<sup>1</sup> University of Bremen, Bibliothekstraße 1, 28359 Bremen, Germany  
eko@biba.uni-bremen.de

<sup>2</sup> BIBA – Institut für Produktion und Logistik, Hochschulring 20, 28359 Bremen, Germany

**Abstract.** Various sustainability reporting tools (SRTs) already exist, such as ISO 14001, Carbon Disclosure Project (CDP), and Greenhouse Gas Protocol (GGP). However, these tools focus on calculating total environmental impact for reporting to external parties, rather than providing guidance to a company on obtaining measures needed to identify improvement potentials within its production. This is due to low granularity of data measurements dictated by the SRTs, since insights only available from higher granular data are typically needed to derive actionable improvements. Understandably, differentiating for which processes higher granularity is needed is not always straightforward. Thus, this paper presents a guideline concept to support manufacturers in determining the required data and data granularity to identify improvement potential, while also assessing the ecological impact of their production. Firstly, energy consumption (electricity and heat), water and material use are determined to be the most relevant measures. Secondly, a structured categorization of production steps is created. As a starting point, selected metal working processes according to DIN 8580 are incorporated into the guideline. Thirdly, the data/device hierarchy from the Reference Architecture Model Industry 4.0 (RAMI 4.0) is used to define three data granularity levels. Finally, a structured approach for determining ideal data granularity for each production step is developed and applied to build an initial version of the guideline. An evaluation shows that the guideline recommends appropriate data granularities, promising to be a useful tool for manufacturers wanting to improve their ecological impact.

**Keywords:** Data granularity · Environmental impact · Production

## 1 Introduction

The manufacturing industry is responsible for one third of global CO<sub>2</sub> emissions [1]. To contain and minimize the negative consequences of human-caused environmental impacts, companies and legislators are attempting to counteract the harmful trend that is already emerging [2]. Due to political regulations e.g., the German Climate Protection Plan legislations such as the Climate Protection Act, CO<sub>2</sub> pricing, or the EU taxonomy

are increasing pressure on companies to measure and report their environmental impact. Various guidelines provided by different rating and reporting organizations are available to direct companies in such measurements. However, these existing guidelines show shortcomings [3–7]. The core problem is the low granularity of measurement dictated by these guidelines. Often only the overall environmental impact of the company is required to be measured, rather than allocation to single product units or machines. Standards such as ISO 14001 or the CDP framework tend to address external stakeholders rather than to support internal identification, analysis and optimization of operational environmental impacts [3]. Especially not at the production machine level. The result is that energy consumption and environmental impact of the entire factory is known, while which production step or machine is responsible and where the impact can be reduced remains unknown.

The goal of the research presented in this paper is to develop a guideline for manufacturers to determine the data needed to identify improvement potentials, while assessing the ecological gate-to-gate impact of their production. The intended use is for a quick initial assessment of which data should be measured with which granularity for the main processes in the facility. With this knowledge a more informed decision can be made where to invest resources to collect data.

## 2 Brief Overview of Common SRTs and Weaknesses

To measure and report their environmental impacts, companies rely on various reporting and disclosure frameworks and standards, which are collectively known as corporate sustainability reporting tools (SRTs). A direct comparison of the most common SRTs shows that they focus mainly on information at the company level. Only ISO 14001 addresses the process and product levels. Here however, the entire product life cycle is considered and not just gate-to-gate production. The comparison of common SRTs is summarized in Table 1, below.

The shortcomings of the existing SRTs have already been shown. The existing efforts to improve STRs can be summarized into three groups. Firstly, efforts looking for an approach to make SRTs more accessible and easier to apply [3, 8, 9]. Secondly those aiming to use more data and a higher level of granularity to uncover their own optimization potential [1, 10]. Thirdly, those developing concepts to reduce uncertainties and assumptions in life cycle assessments (LCAs), to make more robust statements about environmental impacts [11–13]. The authors found no approaches including all three of these areas, which is a gap to guideline aims to fill.

## 3 Development of Guideline

### 3.1 Guideline Structure

Based on the shortcomings of existing SRTs and the resulting challenges, the following four requirements (R1-R4) are defined for the guideline: R1: Indicators must be measurable, R2: System boundaries to gate-to-gate production, R3: Identify optimization potential & allow prioritization, R4: Easy to understand and apply.



**Table 1.** High-level qualitative comparison of the three most common SRTs.

Coverage	CDP	GHG protocol	ISO 14001 <sup>a</sup>
Company level	High	High	High
Process level	Low/none	Low	High
Product level	Low/none	Low	High
Environmental categories (PEF <sup>b</sup> , PCF <sup>c</sup> )	PEF	PCF	PEF
Product lifecycle	Cradle-to-Grave, Cradle-to-Gate	Cradle-to-Grave, Cradle-to-Gate	Cradle-to-Gate, Cradle-to-Grave, Gate-to-Gate

<sup>a</sup>Incl. ISO 14020, ISO 14025, ISO 14040/44, ISO 14067.

<sup>b</sup>Product Environmental Footprint.

<sup>c</sup>Product Carbon Footprint.

Firstly, the required data that the guideline recommends to be collected is derived based on the main ways production systems cause ecological impact [14, 15]. As a result, the following data types were selected: energy demand (electricity, heat), water demand, material use, process time (machine times in the four statuses off, start-up, idle, operation), and scrap amount.

Secondly, a structure for the guideline is developed. Long-term, the guideline should be developed for all manufacturing processes, but for the initial concept version the authors have focused on discrete production processes. A classification according to DIN 8580 is adopted, which is a widespread standard that provides detailed main groups, groups and subgroups covering all discrete processes. To manage the scope, not all processes from the standard are included in the guideline; a selection is made based on which processes a) are relevant for the later application example and b) are frequently used in the context of discrete production. The following subgroups are included in the guideline: 2.1.1 Rolling, 2.1.4 Indentation, 2.2.2 Deep drawing, 3.1.1 Shear cutting, 3.1.2 Knife cutting, 3.6.4 Solvent cleaning, 5.4.2 Electrostatic coating. See DIN 8580 for descriptions [16].

Thirdly, to define levels of data granularity and to evaluate where information about the production steps in a manufacturing company is generated RAMI 4.0 is chosen. RAMI 4.0 is a popular conceptual architectural model created to provide companies with a framework for approach and deploying Industry 4.0 initiatives [17]. Specifically, the hierarchy dimension of RAMI 4.0 is adopted into the guideline, as shown in Fig. 1. RAMI 4.0, rather than the classical automation pyramid from DIN EN 62264 [18] was chosen because RAMI 4.0 was conceived specifically with manufacturing systems of the future in mind; with increasing connectivity across value, fewer companies will have a rigid hierarchy according to DIN EN 62264 or other standards, but rather take on a more flexible network structure [19].

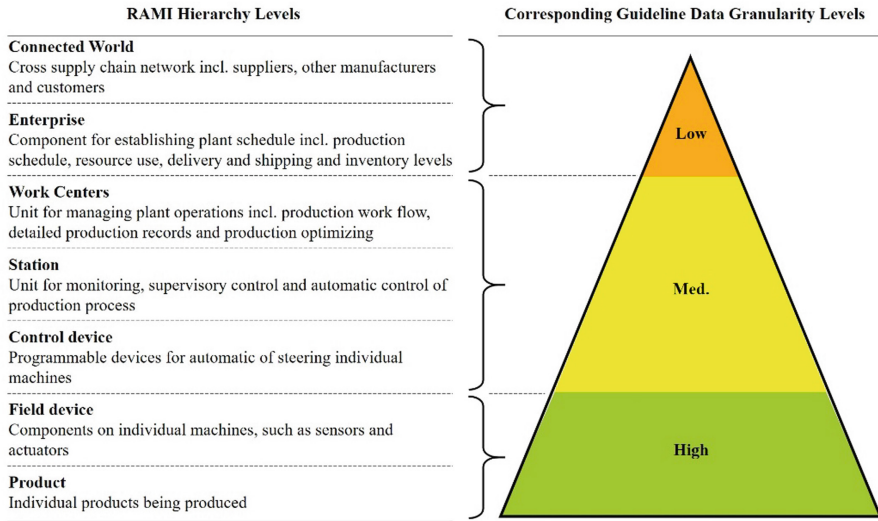


Fig. 1. Definition of guideline data granularity levels, based on RAMI 4.0 hierarchy levels [17].

### 3.2 Determining Data Granularity Levels

Based on the guideline requirements, the required data, the seven selected manufacturing processes and the data granularity levels, an evaluation matrix is developed, which dictates a granularity level for each manufacturing process. The matrix consists of a list of process characteristics, their qualitative relative values, an evaluation of each value and the resulting recommended granularity level. Evaluating all characteristics together results in an overall granularity recommended for the process.

The following characteristics are considered: machine power, process time (off, start-up, idle, run-time, operation), auxiliary materials (e.g., chemicals or lubricants), tool properties (weight and dimensions of the tool), heat (thermal energy demand), water demand and scrap. Machine power describes the maximum power that the machine can deliver. With a high maximum power, the influence on the granularity is generally high. Process time refers to the different electrical energy demand of a machine depending on the time of measurement. Typically, the energy demand increases sharply when a machine is started and then decreases again when it reaches the operating state. However, the energy consumption also varies when the machine is idle, i.e., between two work steps, and when the work is being performed. Thus, the process times have an influence on the actual energy consumption of a machine. Auxiliary materials such as coatings and lubricants are considered. These are typically used to prevent damage to the workpiece during processing such as forming. However, they must be removed again when the product is finished. The more auxiliary materials are used during the production of a product, the more effort (mechanical work, as well as use of water or other solvents) is necessary in the end to separate the auxiliary materials from the workpiece or product. Tool properties refer to the tool to be moved in the machine. This can be, for example, a small sharp saw blade or several punches or bolts moving up and down behind each other

to deform a metal sheet. Depending on the tool properties, the energy requirement, and the duration of the work to be performed change. Thus, the impact on granularity is also high. Heat, water consumption and scrap can clearly have a high influence on the required data granularity and vary among production processes. The scope of applicability considers whether a manufacturing process is usually used for different materials or products, or only one or few specific ones. If the scope of applicability is versatile and the influence on other characteristics is large, a higher granularity should be selected.

Following the above approach, each characteristic is given a corresponding granularity level, resulting in a list of various granularity levels. If different granularity levels have been determined, the characteristics tool properties and scope of applicability are given higher weight. The following rules should be observed when selecting the granularity. If the influence on the granularity of all characteristics is the same, then this granularity level is selected as the overall required granularity for the process. If the influence on the granularity of all characteristics is not the same, the granularity level selected for tool properties and scope of applicability determines the granularity, though strong variations tend to indicate that the assessment may have faults. In Table 2. Below, the evaluation matrix for deep drawing is shown as an example.

**Table 2.** Data granularity evaluation matrix, applied on the deep drawing process.

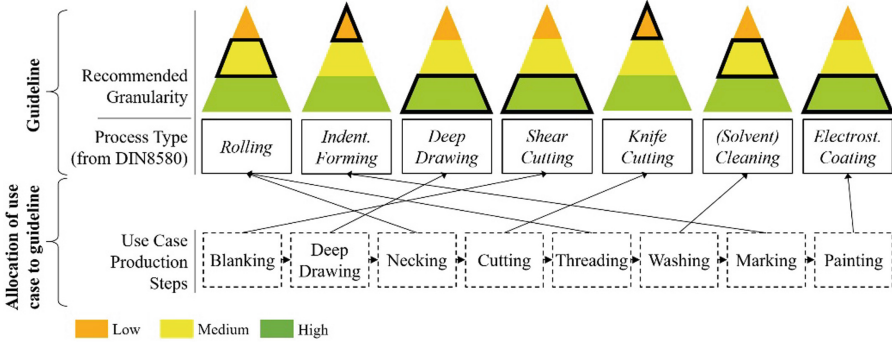
Characteristic	Value	Evaluation	Granul
Machine power	High	Large range of the machine power, incl. High energy consumption	High
Process time	Varies	Depending on material and work piece size	High
Auxiliary materials	Much	Much lubricant is needed	High
Tool properties	Heavy	Massive stamp is moved	High
Heat	No	NA	Low
Water	No	NA	Low
Scrap	No	NA	Low
Scope of applicability	Versatile	Depending on the material, the force required differs significantly	High
<b>Resulting granularity</b>			<b>High</b>

This procedure was carried out for all seven previously selected process types and resulted in a respective granularity level for each process type (Fig. 2).

## 4 Application Use Case Evaluation

For evaluation purposes, the guideline was applied to the production of a 50 by 20 cm aluminum canister (further details omitted for confidentiality). First, the production steps from the production of the canister were allocated to the DIN 8580 processes in the guideline (Fig. 2). Thus, the required granularity for each production step of the

aluminum canister can directly be read from the guideline. To evaluate whether the granularities recommended by the guideline are appropriate, the following question is posed for each production step: “would a higher data granularity level provide additional insights, or would a lower level provide similar insights with less effort?”.



**Fig. 2.** Application of the guideline to the use case production steps, to determine appropriate data granularity level for each step.

For the production steps marking and cutting, the guideline recommends the granularity low. In this context low granularity consists of process step information derived from high-level information from the enterprise resource planning system (ERP), rather than any direct measurements of the process and its machines. Closer evaluation reveals that marking and cutting have only very small contributions to the environmental indicators. Therefore, no significant optimization potentials are to be expected from analyzing the production steps in detail using medium or high granularity data. Thus, low measurement granularity is an appropriate recommendation for these two steps.

For the production steps necking, threading, and washing, the guideline specifies a granularity level of medium. This means that the data should be collected at the production process level, for example using the manufacturing execution system (MES) or supervisory control and data acquisition (SCADA) systems. The medium granularity level for washing, for example, is justified because this is where most of the water needed for the cylinder production is used. A high granularity level is not necessary for washing since almost all the water consumption for the cylinder production occurs at this one step; few additional insights could be gained by measuring water consumption per product being washed, since this can simply be calculated by dividing total water consumption by number of products (of the same type) washed.

For the production steps blanking, deep drawing and painting, the guideline recommends a high granularity. This is confirmed by the high influence of the three production steps on several of the environmental indicators examined. These steps have the highest energy requirements (in order: painting, deep drawing, blanking) of all steps, painting has a long process cycle time, all these steps use many auxiliary materials and heavy tools (blanking, deep drawing) and blanking is responsible for the most scrap. The additional effort for measuring the data on field device or product level is justified by the insights that would otherwise be missed. For example, machine power, as well as scrap,

in relation to the sheet thickness for blanking, could only be measured at high granularity, and could reveal insights on whether machine settings are over-dimensioned and thus wasting energy and material.

## 5 Conclusion

The associated pressure from society and politics has led to companies having to measure, disclose and ultimately improve their environmental impact. Various standards and frameworks already exist for this purpose. However, it has become apparent that these are more suitable for informing external stakeholders than for disclosing optimization potentials within the company's own production. The main problem identified by the authors is a lack of granularity in the SRTs for allocating environmental impacts to production lines, machines or even products. Thus, the authors developed a guideline that specifies a level of granularity for seven manufacturing processes to not only determine the environmental impact of gate-to-gate production, but to also to identify opportunities to reduce this overall impact. The required data were defined in terms of energy, water, and material demand. To provide structure to the many different production techniques, the focus was initially limited to seven processes from the DIN 8580 standard. RAMI 4.0 was then used to define the data granularity levels low, medium, and high. Finally, the required granularity level for each production step was determined by following a structure approach in the form of an evaluation matrix. An evaluation of the guideline on a real-life manufacturing system has shown that appropriate granularity levels are recommended by the guideline, confirming that it has potential to be a useful tool for manufactures wanting to reduce their environmental impact.

Even though the guideline has recommended the right level of granularity in places where the production steps have a high impact, there is still room for improvement. Firstly, the same manufacturing process can vary strongly depending on the application and industry, potentially resulting in different ideal measurement granularities. Thus, even within the detailed catalog of DIN 8580 further differentiation would be valuable. Secondly, only a small selection of certain manufacturing processes has been considered, and further processes need to be added in order for the guideline to be applicable to more manufacturers.

The authors find three main efforts most relevant for future research. Firstly, is to obtain more company data to validate the existing recommendations for the granularity levels for the reasons mentioned above. Secondly, additional production techniques within DIN 8508, and also outside the realm of discrete production, should be investigated and be incorporated using the same approach which this paper has shown to be effective. Thirdly, expanding the guideline to also recommend the required data accuracy, in addition to the granularity, for different processes and situations could be of great value to manufacturers.

**Acknowledgements.** This research has been funded by the German Federal Ministry for Economic Affairs and Climate Action (BMWK) through the project “ecoKI” (03EN2047A). The authors wish to acknowledge the funding agency and all project partners for their contribution.

## References

1. Kellens, K., Renaldi, Dewulf, Wim, Dufloy, J.R.: The CO2PE!-initiative (cooperative effort on process emissions in manufacturing). In: International Framework for Sustainable Production (2010)
2. United Nations Framework Convention on Climate Change (UNFCCC): Adoption of the Paris Agreement (2015)
3. Feng, S.C., Joung .C.B. (Eds.): An overview of a proposed measurement infrastructure for sustainable manufacturing. In: Proceedings of the 7th Global Conference on Sustainable Manufacturing (2009)
4. Mani, M., Madan, J., Lee, J.H., Lyons, K.W., Gupta, S.K.: Sustainability characterisation for manufacturing processes. *Int. J. Prod. Res.* **20**, 5895–5912 (2014)
5. DIN EN ISO 14001:201511: Umweltmanagementsysteme\_ - Anforderungen mit Anleitung zur Anwendung (ISO\_14001:2015); Deutsche und Englische Fassung EN\_ISO\_14001:2015. Beuth Verlag GmbH, Berlin (2015)
6. ISO: ISO 14001 - Introduction to ISO 14001:2015 (2015)
7. Zuo, Y., Tao, F., Nee, A.Y.C.: An Internet of things and cloud-based approach for energy consumption evaluation and analysis for a product. *Int. J. Comput. Integr. Manuf.* **4–5**, 337–348 (2018)
8. Dufloy, J.R., et al.: Towards energy and resource efficient manufacturing: a processes and systems approach. *CIRP Ann.* **68**(2), 587–609 (2012)
9. Siew, R.Y.J.: A review of corporate sustainability reporting tools (SRTs). *Journal of Environmental Management*, 180–195 (2015)
10. ElMaraghy, H.A., Youssef, A.M., Marzouk, A.M., ElMaraghy, W.H.: Energy use analysis and local benchmarking of manufacturing lines. *J. Clean. Prod.* **163**, 36–48 (2017)
11. Bałdowska-Witos, P., et al.: Managing the uncertainty and accuracy of life cycle assessment results for the process of beverage bottle moulding. *Polymers* **12**(6) (2020)
12. Davé, A., Ball, P., Salonitis, K.: Factory eco-efficiency modelling: data granularity and performance indicators. *Procedia Manuf.* **8**, 479–486 (2017)
13. Ziyadi, M., Al-Qadi, I.L.: Model uncertainty analysis using data analytics for life-cycle assessment (LCA) applications. *Int. J. Life Cycle Assess.* **24**(5), 945–959 (2018). <https://doi.org/10.1007/s11367-018-1528-7>
14. Kuszewski, J.: The OECD Sustainable Manufacturing Toolkit
15. Stark, R., Seliger, G., Bonvoisin, J. (eds.): SPLCEM, Springer, Cham (2017). <https://doi.org/10.1007/978-3-319-48514-0>
16. DIN 8580: DIN 8580 (2020)
17. VDI/VDE Society: GMA Status Report RAMI 4.0 (2015)
18. DIN EN 62264-1: DIN EN 62264-1:2014-07, Integration von Unternehmensführungs- und Leitsystemen\_ - Teil\_1: Modelle und Terminologie (IEC\_62264–1:2013); Deutsche Fassung EN\_62264-1:2013. Beuth Verlag GmbH, Berlin (2014)
19. Plattform Industrie 4.0: RAMI 4.0 - Ein Orientierungsrahmen für die Digitalisierung (2018)



**Open Access** This chapter is licensed under the terms of the Creative Commons Attribution 4.0 International License (<http://creativecommons.org/licenses/by/4.0/>), which permits use, sharing, adaptation, distribution and reproduction in any medium or format, as long as you give appropriate credit to the original author(s) and the source, provide a link to the Creative Commons license and indicate if changes were made.

The images or other third party material in this chapter are included in the chapter's Creative Commons license, unless indicated otherwise in a credit line to the material. If material is not included in the chapter's Creative Commons license and your intended use is not permitted by statutory regulation or exceeds the permitted use, you will need to obtain permission directly from the copyright holder.





# Sustainability Impacts of Global Used Clothing Trade and Its Supply Chain

Kanchana Dissanayake<sup>1,2</sup>  and Rudrajeet Pal<sup>1</sup> 

<sup>1</sup> Department of Business Administration and Textile Management, Swedish School of Textiles, University of Borås, Borås, Sweden

{Kanchana.dissanayake, Rudrajeet.Pal}@hb.se

<sup>2</sup> Department of Textile and Apparel Engineering, University of Moratuwa, Moratuwa, Sri Lanka

**Abstract.** Global trade of used clothing, which comprises a series of activities that connect the Global North to the Global South, has grown substantially over the years. This paper analyses the trade data of the export/import trade of used clothing to provide an overview of global trade statistics and explores the sustainability impact of the used clothing trade. Both qualitative and quantitative secondary data were employed in the study. Analysis of export data revealed a declining trend, which may be attributed to the import bans of used clothing and new cheap imports from Asia. While the United States is constantly being the top exporter, and Pakistan is the top importer, the value of exports grew the fastest in China during the last decade. Analysis of sustainability impacts revealed both positive and negative facts. Used clothing markets support thousands of livelihoods and provide affordable clothing for those who live in poverty; however, the fast fashion phenomenon is threatening this important trade. Therefore, this study urges an investigation of alternative business models to reutilize clothing waste. Remanufacturing and recycling-based business models, when implemented in the Global South, could provide viable solutions to reutilize excess clothing while enhancing the sustainability benefits. Developing collaborative relationships among the stakeholders of the used clothing supply chain is immensely necessary to implement such disruptive business models and to capture values along the supply chain.

**Keywords:** Used clothing · Sustainability · Supply chain

## 1 Introduction

The global consumption of used clothing has been increasing. According to the UN Comtrade data, the total value of used clothing exports in 2020 amounts to US\$ 4 billion [1]. Although the used clothing trade is relatively small than the trade of new clothing, representing nearly 0.6%, it makes a significant impact on developing economies. For instance, the trade of used clothing carries a substantial value for some African countries, compared to the sale of new clothing, which accounts for over one-third of all garments purchased by Africans [2]. The demand for used clothing has increased since the 1990s, followed by the economic liberation of many third-world countries [3]. Currently, almost



all countries are involved in this trade, either as exporters, importers, or processors [4]. It is argued that the used clothing trade reflects the inequality among the world's population and the differences in the level of economic development between the Global South and the North [5].

The used clothing supply chain is highly globalized, complex, and fragmented, which consists of various stakeholders and activities. This trade is also accompanied by smuggling and illegal trade practices [4, 6], making it difficult to ensure its traceability. A typical supply chain of the used clothing trade includes charities, commercial waste collectors, sorters, exporters, importers, wholesalers, and market traders. Used clothes are collected by charities and commercial waste collectors in the Global North sorted based on the quality, garment types, or fabric types, and exported to be reused in the Global South, where most of the consumers cannot afford to pay for new clothing. However, this trade is affected from time to time by trade policies, import bans, and changes in taxes and tariffs [3, 7]. Regardless of the obstacles, the used clothing trade has grown into a profitable global business. It has become a million-dollar global business that is spread among various geographical regions, which means the sustainability impacts are appearing on a global scale as well.

The used clothing trade gained less attention in the scholarly literature and the studies focused on the Triple Bottom Line (TBL) sustainability impacts of this trade are limited. However, with the ever-increasing quantities of discarded clothing and their overflow from the Global North to the South, it is becoming important to explore this trade in terms of its global scale and the TBL sustainability impacts, which are little understood so far. On the other hand, TBL sustainability of this trade is questionable due to lack of transparency in its global supply chain. To fulfill the gap, this paper aims to formulate an overview of the North-South used clothing trade statistics, recent trends, and its contribution to TBL sustainability.

## 2 Methodology

Given the intention of this study of developing an understanding of the global used clothing trade and its sustainability impacts, the paper draws on secondary literature to conduct a review work. Both qualitative and quantitative secondary data were employed in the study. A quantitative trade data analysis was conducted using the data extracted from the UN Comtrade database for the HS code 6309-textiles; worn clothing and other worn articles. Global import/export values for ten years (2010–2020) were extracted and analyzed to provide an overview of the used clothing trade statistics and recent trends. Secondly, a systematic literature review has been conducted to gain insight into the sustainability impacts of the global used clothing trade. A broader search was conducted using keywords of “used cloth\*”, “secondhand cloth\*”, “sustainability”, or a combination of them. The search was limited to the papers published since the year 1990 and were written in English. The search resulted 234 articles from the Scopus database. The articles were first screened by reading the titles and abstracts to exclude the articles that were not directly relevant to the used clothing trade and its impacts. For example, papers were excluded because they focused on textile recycling and sustainability benefits. The first screening yielded 51 articles. A full-text reading was carried out in

the second stage of the screening process and further 36 articles were excluded, which were mostly focused on consumer attitudes toward used clothing. There were 15 articles selected for the analysis. The articles were categorized based on their impact on the TBL sustainability and analyzed in Sect. 3.2.

### 3 Results

#### 3.1 Global Used Clothing Trade

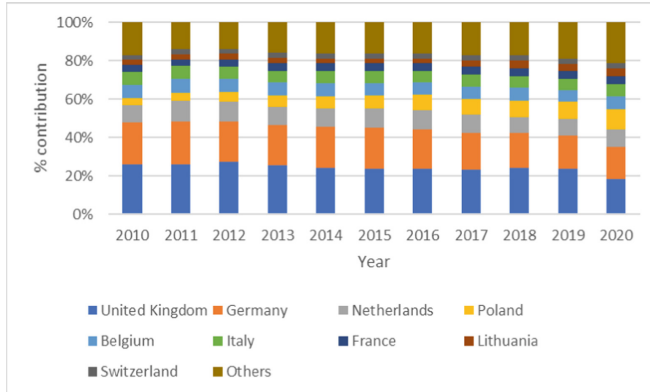
The used clothing trade is spread across various geographical regions in the world. Table 1 presents a summary of the analysis of the average annual exports of the top 10 exporters of used clothing between 2010 and 2020. Major exporters are the USA, UK, Germany, and the Republic of Korea. While historically used clothing exports were limited to the Global North, there is an increasing trend that countries in the Global South position themselves as exporters. For instance, in 2020, China has become one of the top three exporters of used clothing in the world. Between 2010 and 2020, the value of used clothing exports grew the fastest in China from US\$10 million in 2010 to US\$382 million in 2020, with an average annual growth rate of 56%. The USA remains the largest exporter in terms of both value and volume in the last 10-year period. After 2018, a declining trend in world exports can be observed. This may be largely attributed to the import bans/ restrictions imposed by some African countries in 2019.

**Table 1.** Annual average exports of top 10 exporters for the period of 2010–2020

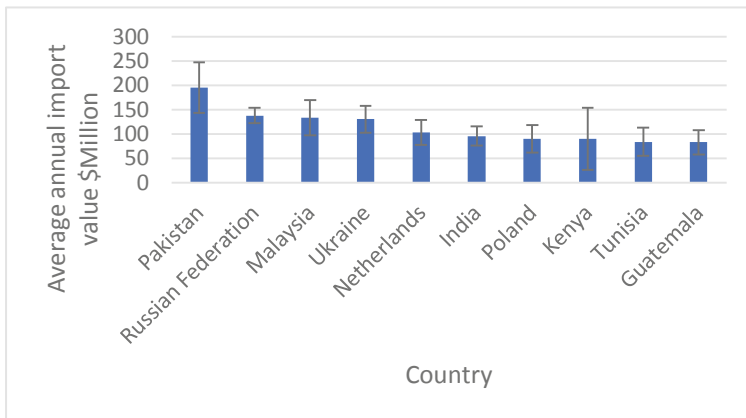
Annual average ( $\pm$ SD) Exports (volume)		Annual average ( $\pm$ SD) Exports (value)	
Country	Quantity (1000 tons)	Country	Value (\$ Million)
USA	755 $\pm$ 27	USA	639 $\pm$ 74
Germany	496 $\pm$ 29	United Kingdom	503 $\pm$ 79
United Kingdom	351 $\pm$ 22	Germany	416 $\pm$ 57
Rep. of Korea	303 $\pm$ 19	Rep. of Korea	315 $\pm$ 40
Japan	226 $\pm$ 28	China	200 $\pm$ 130
Netherlands	167 $\pm$ 14	Netherlands	198 $\pm$ 26
China	165 $\pm$ 107	Canada	150 $\pm$ 31
Italy	147 $\pm$ 16	Poland	146 $\pm$ 46
Poland	141 $\pm$ 44	Belgium	138 $\pm$ 17
United Arab Emirates	133 $\pm$ 106	Italy	130 $\pm$ 11

Analysis of the export values of used clothing based on continents revealed that Europe is leading the world exports of used clothing with a percentage contribution of 51%, followed by Asia (27%). Within the European continent, the major contributor to the export trade is the United Kingdom, followed by Germany, Netherlands, Poland,

and Belgium (Fig. 1). Contribution to total exports from the United Kingdom, Germany, and the Netherlands has declined over the years, while the share of Poland has risen. Belgium, Italy, France, Lithuania, and Switzerland have maintained a steady supply for over a decade, but the share of the rest of the European countries is growing.



**Fig. 1.** Percentage contribution to the exports in Europe by value



**Fig.2.** Average annual import value of top 10 importers for the period of 2010–2020

Figure 2 presents the average annual import values of the top 10 importers of used clothing between 2010 and 2020 by value. The leading five importers of used clothing are Pakistan, Russian Federation, Malaysia, Ukraine, and the Netherlands, with an annual average of more than US\$100 million. The analysis revealed that imports of used clothing grew more than doubled in the Netherlands (127%) and Guatemala (119%) over 10 years, whereas Pakistan recorded a growth rate of 89% between 2010 and 2020. The import trade is not exclusively targeted at the South, significant amounts go to countries such as Netherlands and Poland. However, these European countries have large sorting facilities, which often represent interim destinations for used clothing.

### 3.2 Sustainability Impacts of the Used Clothing Trade

Analysis of trade data revealed that the used clothing trade stretched over a wide array of geographical regions, however, among the existing studies, many are devoted to African countries, which are considered leading destinations for used clothing. According to trade data, Asian countries such as Pakistan, Malaysia, and India are listed among the top 10 importers of used clothing, which deserve equal attention in the research agenda. An analysis of the TBL sustainability of the used clothing trade based on the existing literature is presented in this section.

**Environmental Impacts.** The used clothing trade brings positive environmental impacts in terms of pollution reduction and resource conservation. Extending product life by reusing garments is the best way to minimize virgin material requirements and the energy used in the extraction and processing of raw materials. Extending garment life will also recapture material value, reduce waste and pollution, and the number of new items that are otherwise purchased. For example, the purchase of 100 used garments would save between 60 and 85 new garments, depending on the place of use, and cause a 14% reduction in global warming in the case of the cotton T-shirts or a 45% reduction in human toxicity for the polyester/cotton trousers [8]. Furthermore, for every kilogram of virgin cotton replaced by used clothing, 65 kWh energy is saved, and for every kilogram of polyester replaced, 95 kWh is saved [9]. The carbon emission that occurred by the transportation of used clothing bales is found to be less compared to the carbon emitted from new clothes manufacturing [10]. These factors indicate significant environmental benefits of the direct reuse of clothing.

However, the rapid development of the fashion industry and the fast fashion phenomenon have significantly contributed to generating massive quantities of waste, which in turn fueled the growth of the used clothing trade. The average number of times a garment is worn before disposing of has decreased significantly, which means technically the materials of discarded clothing must be of good quality. However, fast fashion garments are found to be poor in quality, and therefore, traders are facing difficulties to sell them in destination markets. That means the recipient countries such as Africa are becoming dumping grounds for excess, low-quality fast fashion clothing [11]. Furthermore, an oversupply of used clothing is likely to encourage overconsumption and throwaway culture in destination markets because used clothing is readily available and affordable [12]. This may lead to a devastating situation and hinder the environmental benefits of clothing reuse.

**Economic Impacts.** The used clothing industry plays an important role in generating new employment opportunities. The types of jobs include collection, sorting, transportation, repair, washing, reconstruction, packaging, and trading [13]. In Rwanda, every \$10,000 spent by consumers on used clothing supports 4.8 full-time workers annually [14]. In Kenya, the used clothing industry employs more people than domestic manufacturers [15]. Apart from that, this trade generates government revenue from import tariffs, issuing trade licenses, and renting market stalls [3]. New business models are becoming apparent, where the tailors and designers work on restyling used clothes to fit the local consumer and culture [16]. When comparing the prices of new and used clothing, new clothing costs three to four times more than used clothing. For instance,

a men's new shirt costs around US\$ 14.5–21.8, whereas a used shirt costs around US\$ 1.81–7.20 [17].

However, the trade receives frequent criticism for undermining the local apparel industry. For instance, the used clothing trade created a 40% decline in production and a 50% decline in employment in Africa between 1981–2000 [18]. Used clothes are found to be cheaper than locally manufactured clothes, and the factory production could not compete with the cheap prices, which caused the closure of garment factories, mainly in African countries [7, 19]. To safeguard domestic manufacturing industries, either import bans have been implemented or import restrictions are imposed in many African countries [5, 7]. Regardless of import bans, smuggling and other illegal practices are accompanied by the trade. For example, the import of used clothing is prohibited in Iran, but smuggling caused setting up permanent stores for used clothing without any legal fear [13].

Opening up a bale does not always lead to a recovery of the cost for traders in the destination markets, as some items are found to be poor quality, dirty, unfashionable, and ripped [20]. Bales include various items such as warm weather t-shirts, and shorts as well as undesirable items such as curtains and coats [5]. Power inequality in the supply chain and supply and demand imbalances allow exporters to cheat importers by adding undesirable items and gaining benefits of currency fluctuations [5].

**Social Impacts.** The used clothing trade is recognized as an important sector for poverty alleviation in developing countries. This trade includes several labor-intensive activities such as collection, sorting, washing, transportation, and trading. Engaging in such activities allows people to generate income and support their families. Women are often engaged in this business because barriers to entry are low and they can support their family income as well as become self-reliant [19]. This trade also provides clothes at affordable prices, which is one of the basic needs for those who live in poverty. Used clothing is sold for 10–20% of the price of new clothing [13], which creates a greater demand among the majority of the population with low purchasing power [7]. Due to high quality and affordability, used clothing is preferred over locally made clothing [13]. In the Global North, the used clothing trade supports charities by raising funds for humanitarian aid [8].

However, the consumption of used clothing is associated with health and hygiene issues. Skin diseases and louse scabies diseases are some of the risks of using them [13]. Traders have to face some uncertainties associated with buying and selling used clothing such as quality and quantity issues [20]. Apart from that, cultural issues are associated with used clothes as Western clothes are often found to be unsuitable for African culture and beliefs.

## 4 Discussion and Conclusion

Even though used clothing markets are well established, there are rising sustainability issues associated with the trade. The main concern is that the used clothing trade undermines the local manufacturing sector, thus countries are increasingly discussing

the possibility of banning used clothing imports. Analysis of trade data shows a declining trend of exports, yet in general, fast fashion is dominating consumption patterns in the North and thus, clothing disposals are growing. Therefore, it is vital to look for alternative avenues to reutilize them without further harming the environment. Reusing in a circular economy emphasizes local reuse and engaging retailers in the circularity process. For instance, there is an emergence of retailer-owned used clothing lines, which would help to overcome the sustainability issues associated with overseas used clothing markets, offer new opportunities for reuse models, and create new customer segments. Retailer-driven product take-back and resale models would increase customer returns and repurchase trends and boost the local consumption of used clothes. The fundamental for future success is to rearrange the used clothing supply chain by providing a prominent place and responsibility to fashion retailers and brand owners. They are currently disconnected from the used clothing supply chain, but their involvement is immensely necessary to develop new business models and to achieve TBL sustainability of the trade.

Waste and quality issues in the used clothing supply chain are almost hidden. More research is needed to investigate this issue using empirical data. The establishment of remanufacturing centers in the Global South to restyle used clothing and sell them back in the retail store in the North would bring more sustainability benefits to the trade, rather than simply attempting to resell unsuitable stock in destination markets. Moreover, the possibility of shifting the sorting and recycling facilities to developing countries should be investigated, which may provide cheap labor, create job opportunities for the poor, and reduce waste in landfills. Meanwhile, supply chain traceability must be enhanced, and collaborative relationships must be developed among stakeholders to understand how to recapture the maximum value of the goods along the supply chain. More research should be devoted to investigating the TBL sustainability impacts on the entire supply chain, which should include activities beyond trading such as collection, sorting, transportation, and processing of used clothes.

## References

1. UN Comtrade: UN Comtrade Database. <https://comtrade.un.org/>. Accessed 3 Mar 2022
2. Fields, S.: The Beneficial Nature of the Second Hand Clothing trade in Sub-Saharan Africa (2005)
3. Hansen, K.T.: Helping or hindering? Controversies around the international second-hand clothing trade. *Anthropol. Today* **20**(4), 3–9 (2004)
4. Baden, S., Barber, C.: The Impact of the Second-Hand Clothing trade on Developing Countries (2005)
5. Brooks, A.: Stretching global production networks: the international second-hand clothing trade. *Geoforum* **44**, 10–22 (2013)
6. Gauthier, M., Hormiga, F.: The cross-border trade of used clothing between the United States and Mexico. In: *Borderlands: Comparing Border Security in North America and Europe*, pp. 95–116 (2007)
7. Brooks, A., Simon, D.: Unravelling the relationships between used-clothing imports and the decline of African clothing industries. *Dev. Change* **43**, 1265–1290 (2012)
8. Farrant, L., Olsen, S.I., Wangel, A.: Environmental benefits from reusing clothes. *Int. J. Life Cycle Assess.* **15**, 726–736 (2010)

9. Woolridge, A.C., Ward, G.D., Phillips, P.S., et al.: Life cycle assessment for reuse/recycling of donated waste textiles compared to use of virgin material: an UK energy saving perspective. *Resour. Conserv. Recycl.* **46**, 94–103 (2006)
10. IEA & MCAK: *The State of Second-Hand Clothes and Footwear Trade in Kenya*, pp. 1–36 (2021)
11. Wetengere, K.K.: Is the banning of importation of second-hand clothes and shoes a panacea to industrialization in East Africa? *African J. Econ. Rev.* **6**, 119–141 (2018)
12. Isla, V.L.: Investigating second-hand fashion trade and consumption in the Philippines: expanding existing discourses. *J. Consum. Cult.* **13**, 221–240 (2013)
13. Bazzi, K.: Review of the socio-economical effects of second hand clothing smuggle to iran (with the comparative approach between Zabol and Orumieh City in the East and West of the Country). *J. Basic. Appl. Sci. Res.* **2**, 2530–2540 (2012)
14. Haggblade, S.: The flip side of fashion: used clothing exports to the third world. *J. Dev. Stud.* **26**, 505–521 (1990)
15. Wolff, E.A.: The global politics of African industrial policy: the case of the used clothing ban in Kenya, Uganda and Rwanda. *Rev. Int. Polit. Econ.* **28**, 1308–1331 (2021)
16. Hansen, K.T.: Transnational biographies and local meanings: used clothing practices in Lusaka. *J. South Afr. Stud.* **21**, 131–145 (1995)
17. Khurana, K., Tadesse, R.: A study on relevance of second hand clothing retailing in Ethiopia. *Res. J. Text. Appar.* **23**, 323–339 (2019)
18. Frazer, G.: Used-clothing donations and apparel production in Africa. *Econ. J.* **118**, 1764–1784 (2008)
19. Imo, B.E., Maiyo, R.C., Imo, B.E., Maiyo, R.C. Lessons from thriving second-hand clothing businesses for Kenya ' s fashion industry. *J. Emerg. Trends Econ. Manag. Sci.* **3**, 32–37 (2012)
20. Brooks, A.: Riches from rags or persistent poverty? The working lives of secondhand clothing vendors in Maputo, Mozambique. *Text J. Cloth Cult.* **10**, 222–237 (2012)
21. Hansen, K.T.: The secondhand clothing market in Africa and its influence on local fashions. *Dressstudy. Autumn* **64** (2014)

**Open Access** This chapter is licensed under the terms of the Creative Commons Attribution 4.0 International License (<http://creativecommons.org/licenses/by/4.0/>), which permits use, sharing, adaptation, distribution and reproduction in any medium or format, as long as you give appropriate credit to the original author(s) and the source, provide a link to the Creative Commons license and indicate if changes were made.

The images or other third party material in this chapter are included in the chapter's Creative Commons license, unless indicated otherwise in a credit line to the material. If material is not included in the chapter's Creative Commons license and your intended use is not permitted by statutory regulation or exceeds the permitted use, you will need to obtain permission directly from the copyright holder.



# Metrics





# Taxonomy for Biological Transformation Principles in the Manufacturing Industry

Magda Berkhahn<sup>1</sup> (✉), Gerald Kremer<sup>1</sup>, Theresa Riedelsheimer<sup>2</sup>, Kai Lindow<sup>2</sup>,  
and Rainer Stark<sup>1</sup>

<sup>1</sup> Technische Universität Berlin, Pascalstr. 8-9, 10587 Berlin, Germany  
m.berkhahn@tu-berlin.de

<sup>2</sup> Fraunhofer IPK, Pascalstr. 8-9, 10587 Berlin, Germany

**Abstract.** Industry and research are seeking answers to current demands in industrial value creation, like resilience of production, sufficient product quality and sustainability of products and processes. A novel line of thought, seeking the accomplishment of those is the Biological Transformation (BT). BT describes the interweaving of biological modes of action, materials and organisms with engineering and information sciences. The conflation of disciplines from natural, technical and social sciences yields in a heterogeneous field of activities with ambiguous technical terms. An ascertainment of principles of BT is required to classify yet undifferentiated patterns in nature-based production, facilitating their systematic implementation in aiming for sustained solutions on current challenges. With increasing research in biomimetic, attempts arise to capture nature-based activities in manufacturing through schematic classifications. Yet, basic semantics representing the effective principles of BT in the manufacturing industry is lacking.

The goal of this publication is to introduce a taxonomy of Biological Transformation in manufacturing based on its core principles Bio Inspiration, Bio Integration and Bio Interaction. Within the research project BioFusion 4.0, the taxonomy was developed and applied to classify technology innovations. The paper presents the taxonomy, its development and application in use cases.

**Keywords:** Biological transformation · Manufacturing · Sustainability · Taxonomy · Biomimicry · Use cases

## 1 Introduction

Industrial companies are in constant progress, moved by trends and long-lasting conversion. Increased public awareness of sustainability issues, increasing political constraints for environmental protection, resource scarcity and supply chain shortages characterize today's market. Mastering these challenges while ensuring product quality with new industrial technology solutions is perhaps the most crucial task of the present time. The internet of things, artificial intelligence, big data or digital twins are promising innovations for that matter [1]. On multiple levels in industry and research digitalization and

Industrie 4.0 are being demonstrated to offer the potential to fundamentally improve various aspects of production such as quality, costs, and sustainability [2, 3]. To this regard, Biological Transformation (BT) is an emerging development in the field of Industrie 4.0. When applied in manufacturing this concept involves the systematic application of processes, principles and resources from biotic nature in technical systems by means of information technology [4]. Systematically applying knowledge about principles of BT in manufacturing is key to achieving promising effects like ecological stability, social well-being and economic resilience in production. This paper focuses on establishing a common language for and a clear definition of BT.

## 2 Biological Transformation in Manufacturing Industry

For the definition of BT in manufacturing, its historical development as well as the relevant fields of action, Industrie 4.0 and digitalization, are analyzed in the following.

**Bioinspired Manufacturing.** The transfer of biological forms and functions to technical application fields is first defined as bionics by J.E. Steele [5] and expanded by W. Nachtigall to include “aspects of the interaction of animate and inanimate systems as well as the economic-technical application of biological organizational criteria” [6]. As a scientific discipline, bionics is also termed *biomimicry*, *biometrics*, *biomimesis*. In design and engineering in particular, databases of biological information sources, are already providing support via context-sensitive search with increasing prominence under the term *biologically inspired design* (BID) as a design movement for environmentally sustainable development [7, 8]. Evolving bionic ties in with new technical possibilities of nano-, bio-, information & communication technologies as well as cognitive sciences and artificial intelligence, which in the longer term is described as converging technologies [9]. In the context of technical innovations, Gleich [10] speaks of evolutionary generalizable optimization principles at the molecular level up to the ecosystem.

**Industrie 4.0 and digitalization In Manufacturing.** Focusing on the industrial manufacturing environment, the merge of the physical and virtual world marks the fourth industrial revolution, where production and information & communication technologies are converging. The vision of Industrie 4.0 describes a highly flexible, resource-saving and urban-compatible production. At the heart of Industrie 4.0 is the smart factory, where humans and machines work hand in hand, supported by intelligent assistance systems [11]. Technological progress and the accompanying digitization, in the sense of the process of introducing and using digital technologies [12], are leading to far-reaching transformation processes at the economic and social level.

**Biological Transformation.** From a production engineering perspective, the BIO-TRAIN study defines “biointelligence” as the interaction of technical, biological and IT systems [13]. Generally, BT is understood as the transfer of principles of natural systems to technical materials, structures and processes, aiming for sustainable value creation [14]. Key concepts of BT are inspiration, integration and interaction [15]. On international level, the white paper “Biologicalisation: Biological transformation in manufacturing” describes these concepts from a production technology perspective [16]. Based on the state of the art in literature, the following definition is derived:

*Biological Transformation in manufacturing is a holistic approach to change industrial value creation towards sustainable optimized product and production systems, by an accelerating convergence of technical, digital, and biological systems in the manufacturing environment. BT proceeds in three complementary developmental modes: (1) the integration of biological materials, structures, organisms, processes and functionalities, (2) the inspiration by nature and the transfer to the design of products and manufacturing technologies as well as (3) the interaction of the bio- and technosphere by means of information technology.*

Existing classification schemes in scope of BT make biological information accessible to engineers and product designers for innovation processes [8, 17]. As a recognized approach the *Biomimicry Taxonomy* supports the inspiration from nature by classifying its functions by a terminology, comprehensible for non-biologists [8]. However, it does not fully capture the integration of biological into technical systems or the interweaving of biological, technical and IT systems. Following the given definition of BT and the potentials of a synergetic convergence of BT with Industrie 4.0, the herein presented taxonomy of Biological Transformation in manufacturing is addressing this research gap, by giving a systematic and more comprehensible overview of effective principles of BT. Providing this knowledge base is the first and essential step in enabling sustainability in manufacturing by means of the Biological Transformation.

### 3 Taxonomy Development and Presentation

#### 3.1 Methodological Approach

A methodology widely established in information science to develop taxonomies was created by R. Nickerson [18]. The taxonomy of Biological Transformation in manufacturing was developed using an updated version of this methodology, ensuring that outcome and process are easily understood by a wide range science groups [19].

The deductive methodology was chosen following the basic subdivision of BT in the principles Bio Inspiration, Bio Integration and Bio Interaction by Bauernhansl [13]. The first taxa were chosen accordingly. Pre-collected characteristics were classified into the taxonomy and additional taxa were deductively derived. Subcategories of Bio Inspiration, Bio Integration, and Bio Interaction were fanned out to modes of action. Bio Inspiration was divided through concepts that describe how and in which forms natural functionalities can be adopted. Herein, the subcategory resilience was further divided by concept of J. Benyus [20]. The subcategory principles of circularity derived from [21, 22, 23]. The subcategory self-x was divided by concepts of Speck et al., Gleich et al., Müller-Schloer et al. and Gausemeier et al. [24–26, 26]. The subcategory functional morphology was divided by concepts of W. Nachtigall [28] and subcategory biomimetic information modelling and processing by a concept described in VDE Norm 6225 [29]. Categories in Bio Integration derived from Matyushenko et al. [30] followed by a broad literature research on principles in biotechnology. Bio Interaction was divided into subcategories, on basis of the IPO-model [31] known from computer sciences, and

with Input of the German Standardization Roadmap on Artificial Intelligence, the High-Level Expert Group on Artificial Intelligence [32, 33]. Herein, biological intelligent information processing and biointelligent communication were divided by concepts of W. Wahlster [34], biohybrid actuation following the work of Ricotti et al. [35].

### 3.2 The Taxonomy of Biological Transformation in Manufacturing

The taxonomy is organized hierarchically by the three core principles Bio Inspiration, Bio Integration and Bio Interaction, visualized in the following Fig. 1.

Within the core principle of Bio Inspiration 28 operating principles are organized into the five groups resilience, principles of circularity, self-x, functional morphology and biomimetic information modeling and processing. The core principle Bio Integration comprises the six groups biosynthesis, biosubstitution, biodegradation and decomposition, bioenergetics, biotherapeutics and biomodification. Within these, 18 effective principles are classified. Nine principles can be divided under the core principle Bio Interaction, which are grouped into biosensors, biological representation, biointelligent information processing, biohybrid actuation and biointelligent communication. This results in a total of 55 taxa, the principles of Biological Transformation in manufacturing, which are currently included in the taxonomy.

### 3.3 Validation of the Taxonomy with Industrial Use Cases

To investigate BT in the manufacturing environment and along a product's lifecycle, seven use cases are elaborated in the research project BioFusion 4.0. The use cases cover various industrial product and manufacturing solutions, ranging from digital twins in bio inspired product engineering, ecological intelligent services for production, intelligent recirculation of materials, biologically optimized process simulation of milling processes [36], bionic integration for networked production systems [37], additive manufacturing with biogenic and biodegradable polymers, up to biointelligent assistant systems for workers. These were used to validate the applicability of the taxonomy. For demonstration purposes the latter two are detailed in Table 1 and thereafter classified as per the taxonomy. With reference to the procedure for bionic design in VDE Standards 6226 and 6220 Part 2 [38, 39], the principles were allocated to the use cases in expert workshops via iterative analysis processes with methods of analogy mapping.

**Use Case 1.** An active exoskeleton responsive through physiological sensors fulfills the principle of *human-technology-interfaces* as part of *biointelligent communication*. Thus, the core principle *Bio Interaction* is applied. By suggesting less stressful postures and patterns to the workers, based on sensory ergonomic data, the workers are enabled to *self-optimization* of their ergonomic posture. Also, the enabling of information-driven adaptability of working modes leads to increased *resilience* of the production system as fewer absences due to health reasons result. Thus, the core principle of *Bio Inspiration* is brought into effect.

**Use Case 2.** Processing of disposed cooking oil by microorganisms into usable raw material is a principle of *biodegradation*, namely *bioconversion*. Simultaneously this

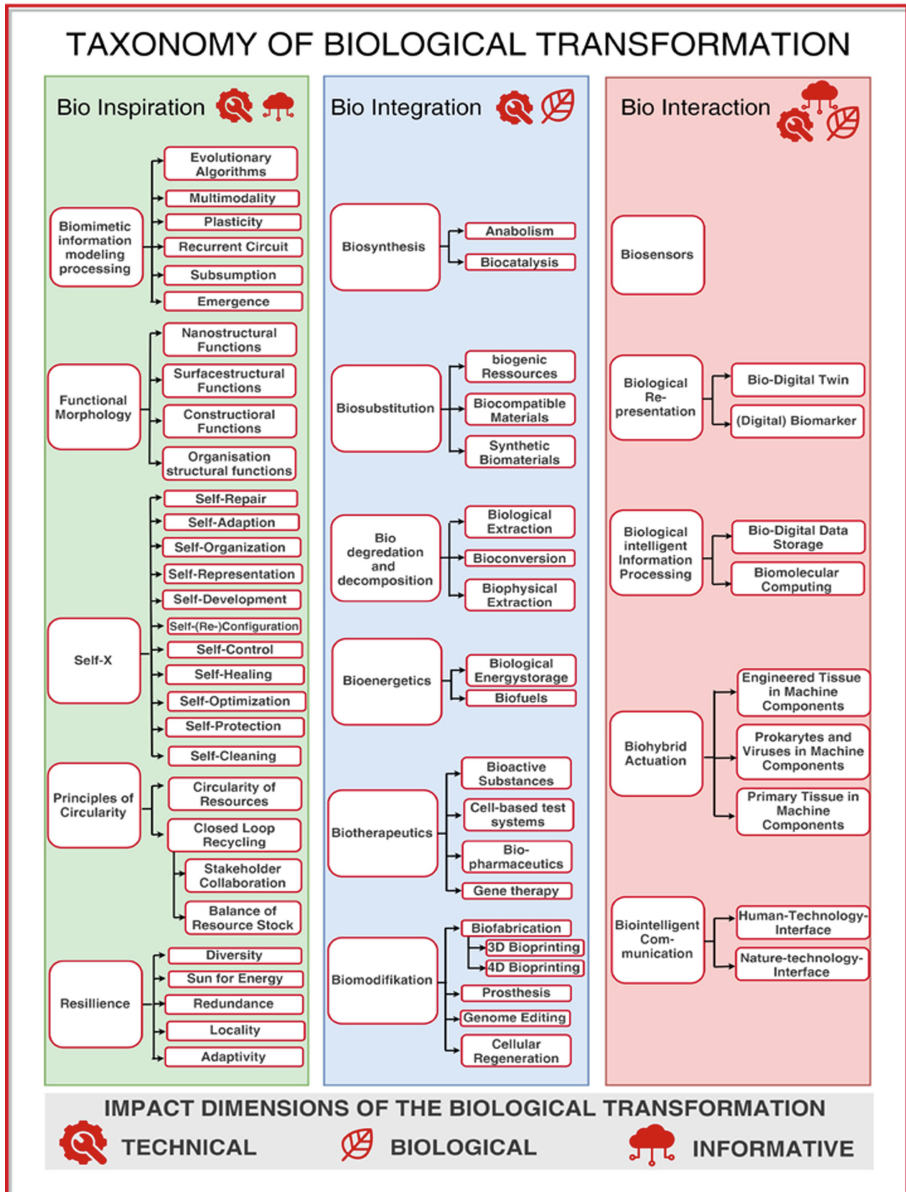


Fig. 1. The taxonomy of Biological Transformation in manufacturing (authors own illustration)

establishes the principle of *anabolism* in *biosynthesis*. The following utilization of the produced biopolymer in 3D printing instead of fossil polymers realizes the principle *biogenic resources* and because the biopolymer is nontoxic when handled by humans the principle of *biocompatible materials* is met in the use case. Thereby the core principle of *Bio Integration* is applied. The reuse of biogenic waste as a raw material establishes a

**Table 1.** Use cases and technological solutions for biological transformation

Use Case 1: Biointelligent assistant systems for worker	
Challenge	Physiological stress for worker during manual work in production environment; unclear impact on workers' health, unclear progress of manual tasks
Solution	Supporting worker during manual tasks with exoskeleton, equipped with sensors; monitoring of physical burden and work progress
Core functions	Data collection with sensors; support with actors; optimization of work mode
Context of use	Wearing during manual assembling by worker to monitor health indicators and work progress at the same time
Application Scenario	Assembly of automotive components, i.e. module for electric batteries as a high stress operations on health state of workers
Added Value	Increased ergonomics; reduced chronic physical overload; increased transparency on assembly quality
Use Case 2: Additive manufacturing with biogenic and biodegradable polymers	
Challenge	Limited resources; linear value creation; high amount of waste while still high need for new components and products
Solution	Usage of waste to produce bio based material for 3D-printing
Core functions	Processing and combination of material; creation of physical systems
Context of use	Printing of components for temporary usage that are biodegradable
Application Scenario	Disposed cooking oil is microbiological converted into biopolymer PHB, which is employed to 3D print consumable parts of tools in industrial production or disposable medical device, like orthosis
Added Value	Reduced resource use; Increased recycling quota

bioinspired *principle of circularity*, namely the principle of *circularity of resources*. The symbiosis is an important part to ensure circularity in ecosystems. The collaboration within the use case exists between producers of food waste, (communal) collectors of recyclable materials and recyclers, processors of polymers, and industrial companies, resulting in a *closed loop recycling* of materials. The primary raw materials, taken from nature for the production of edible oil, are ultimately returned to it through biological treatment of the bioplastic. The principle *balance of stock* takes effect.

## 4 Conclusion

The presented taxonomy for Biological Transformation in manufacturing provides a systematic overview of relevant principle effective in the interfaces of nature, technology and information technology. As technology is further evolving opportunities arise to facilitate BT in manufacturing, which requires a constant update of the taxonomy to

make it a useful instrument for this progression. Particularly, the research on artificial intelligence and bionic information processing is evolving rapidly, setting new standards to be aligned within the taxonomy. As the ultimate goal of BT in manufacturing is sustainability, a necessity exists provide enabling means to industry stakeholders to identify and apply principles of the taxonomy in sustainable innovation processes.

**Acknowledgement.** This paper was written as part of the research project “Biological Transformation 4.0: Further development of Industrie 4.0 by integrating biological principles (BioFusion 4.0)”, funded by the German Federal Ministry of Education and Research (BMBF) and supervised by the Project Management Agency Karlsruhe (PTKA). The responsibility for the contents of this publication lies with the authors.

## References

1. Hirsch-Kreinsen, H., Kubach, U., Stark, R., et al.: Key Themes of Industrie 4.0 (2009)
2. Bergs, T., Schwaneberg, U., Barth, S., et al.: Application cases of biological transformation in manufacturing technology. *CIRP J. Manuf. Sci. Technol.* **31**, 68–77 (2020). <https://doi.org/10.1016/j.cirpj.2020.09.010>
3. Da Xu, L., Xu, E.L., Li, L.: Industry 4.0: state of the art and future trends. *Int. J. Prod. Res.* **56**, 2941–2962 (2018). <https://doi.org/10.1080/00207543.2018.1444806>
4. Byrne, G., Dimitrov, D., Monostori, L., et al.: Biologicalisation: biological transformation in manufacturing. *CIRP J. Manuf. Sci. Technol.* **21**, 1–32 (2018). <https://doi.org/10.1016/j.cirpj.2018.03.003>
5. Steele, J.E.: Living prototypes: the key to new technology. In: Wright Air Development Division. Directorate of Advanced Systems Technology (eds.), Wright Air Development Division, Dayton (1960)
6. Nachtigall, W.: Bionik: Grundlagen und Beispiele für Ingenieure und Naturwissenschaftler, 2. Auflage. Springer eBook Collection Computer Science and Engineering. Springer, Heidelberg (2003). <https://doi.org/10.1007/978-3-642-18996-8>
7. Chakrabarti, A.: Supporting analogical transfer in biologically inspired design. In: Goel, A.K., McAdams, D.A., Stone, R.B. (eds.) *Biologically Inspired Design*, pp. 201–220. Springer, London, London (2014)
8. Hooker, G., Smith, E.: Asknature and the biomimicry taxonomy. *Insight* **19**, 46–49 (2016). <https://doi.org/10.1002/inst.12073>
9. Roco, M., Bainbridge, W.S.: *Converging Technologies for Improving Human Performance: Nanotechnology, Biotechnology, Information Technology and Cognitive Science*. Kluwer Academic Publishers, Dordrecht (op. 2003)
10. von Gleich, A.: Das bionische Versprechen. *ÖW* **22** (2007). <https://doi.org/10.14512/oew.v22.i3.528>
11. Plattform Industrie 4.0 Was ist Industrie 4.0? <https://www.plattform-i40.de/IP/Navigation/DE/Industrie40/WasIndustrie40/was-ist-industrie-40.html>. Accessed 16 May 2022
12. Legner, C., Eymann, T., Hess, T., et al.: Digitalization: opportunity and challenge for the business and information systems engineering community. *Bus. Inf. Syst. Eng.* **59**, 301–308 (2017). <https://doi.org/10.1007/s12599-017-0484-2>
13. Bauernhansl, T., Brecher, C., Drossel, W.: *Biointelligenz: eine neue Perspektive für nachhaltige industrielle Wertschöpfung: Ergebnisse der Voruntersuchung zur biologischen Transformation der industriellen Wertschöpfung (Biotrain)* (2019)

14. Neugebauer, R. (ed.): Springer, Heidelberg (2019). <https://doi.org/10.1007/978-3-662-58243-5>
15. Mieke, R., Bauernhansl, T., Schwarz, O., et al.: The biological transformation of the manufacturing industry – envisioning biointelligent value adding. *Procedia CIRP* **72**, 739–743 (2018). <https://doi.org/10.1016/j.procir.2018.04.085>
16. Byrne, G., Dimitrov, D., Monostori, L., et al.: Biologicalisation: biological transformation in manufacturing. *CIRP J. Manuf. Sci. Technol.* **21**, 1–43 (2018)
17. McInerney, S., Khakipoor, B., Garner, A., et al.: E2BMO: facilitating user interaction with a biomimetic ontology via semantic translation and interface design. *Designs* **2**, 53 (2018). <https://doi.org/10.3390/designs2040053>
18. Nickerson, R.C., Varshney, U., Muntermann, J.: A method for taxonomy development and its application in information systems. *Eur. J. Inf. Syst.* **22**, 336–359 (2013). <https://doi.org/10.1057/ejis.2012.26>
19. Kundisch, D., Muntermann, J., Oberländer, A.M., et al.: An update for taxonomy designers. *Bus. Inf. Syst. Eng.* **64**, 421–439 (2021). <https://doi.org/10.1007/s12599-021-00723-x>
20. Benyus, J.M.: *Biomimicry: Innovation Inspired By Nature* [Nachdr.]. Perennial, New York (2009)
21. Papageorgiou, A., Henrysson, M., Nuur, C., et al.: Mapping and assessing indicator-based frameworks for monitoring circular economy development at the city-level. *Sustain. Cities Soc.* **75**, 103378 (2021). <https://doi.org/10.1016/j.scs.2021.103378>
22. Ellen MacArthur Foundation. *Towards the Circular Economy* (2013)
23. Mabee, W.E.: Conceptualizing the circular bioeconomy. In: Stefanakis, A., Nikolaou, I. (eds.) *Circular Economy and Sustainability*, pp. 53–69. Elsevier, Amsterdam (2022)
24. Speck, T., Knippers, J., Speck, O.: Self-X materials and structures in nature and technology: bio-inspiration as a driving force for technical innovation. *Archit. Des.* **85**, 34–39 (2015). <https://doi.org/10.1002/ad.1951>
25. von Gleich, A., Pade, C., Petschow, U.: *Bionik: Aktuelle Trends und zukünftige Potenziale : 18 Tabellen*. IÖW, Berlin (2007)
26. Müller-Schloer, C., Schmeck, H., Ungerer, T.: Organic computing: a paradigm shift for complex systems. In: *Autonomic Systems*, vol. 1. Springer, Basel (2011). <https://doi.org/10.1007/978-3-0348-0130-0>
27. Gausemeier, J., Frank, U., Schulz, B.: Domänenübergreifende Spezifikation der Prinziplösung selbstoptimierender Systeme unter Berücksichtigung der auf das System wirkenden Einflüsse. In: *Mechatronik 2005 - Innovative Produktentwicklung: VDI-Bericht. Band 1892.1* (2005)
28. Nachtigall, W.: *Bionik: Von der Natur lernen, Orig.-ausg. Beck'sche Reihe, 2436 :C.H. Beck Wissen*. Beck, München (2008)
29. VDI - Verein deutscher Ingenieure (2012) *Biomimetics: Biomimetic information processing. VDI-Richtlinie (VDI 6225)*
30. Matyushenko, I., Sviatukha, I., Grigorova-Berenda, L.: Modern approaches to classification of biotechnology as a part of NBIC-technologies for bioeconomy. *Br. J. Econ. Manag. Trade* **14**, 1–14 (2016). <https://doi.org/10.9734/BJEMT/2016/28151>
31. Jahangir Alam, S.M., Guoqing, H., Rabiul Alam, M., et al.: improved information systems model for Bangladesh. *Telkomnika* **12** (2014). <https://doi.org/10.11591/telkomnika.v12i7.4130>
32. High-Level Expert Group on Artificial Intelligence. *A definition of AI: Main capabilities and scientific disciplines* (2019)
33. DIN e.V., DKE. *German Standardization Roadmap on Artificial Intelligence* (2020). <https://www.din.de/resource/blob/772610/e96c34dd6b12900ea75b460538805349/normungsroadmap-en-data.pdf>
34. Wahlster, W.: Künstliche Intelligenz als Grundlage autonomer Systeme. *Informatik Spektrum* **40**, 409–418 (2017). <https://doi.org/10.1007/s00287-017-1049-y>



35. Ricotti, L., Trimmer, B., Feinberg, A.W., et al.: (Biohybrid actuators for robotics: a review of devices actuated by living cells. *Sci. Robot.* **2** (2017). <https://doi.org/10.1126/scirobotics.aag0495>
36. König, V., Berkhahn, M., Riedelsheimer, T., et al.: Biological transformation in process simulation for enhancing ecological sustainability indicators. *Procedia CIRP* **110**, 53–58 (2022). <https://doi.org/10.1016/j.procir.2022.06.012>
37. Lange, A., Knothe, T., Kohl, H., et al.: Biological transformation: principles to enhance holistic production systems. *Procedia CIRP* **110**, 293–298 (2022). <https://doi.org/10.1016/j.procir.2022.06.053>
38. VDI: Biomimetics - Biomimetic design methodology - Products and processes: Part 2 07.080(VDI 6220 Part 2) (June 2022)
39. VDI: Biomimetics - Architecture, civil engineering, industrial design - Basic principles: Part 1 07.080, 91.010.01(VDI 6226 Part 1) (2015)

**Open Access** This chapter is licensed under the terms of the Creative Commons Attribution 4.0 International License (<http://creativecommons.org/licenses/by/4.0/>), which permits use, sharing, adaptation, distribution and reproduction in any medium or format, as long as you give appropriate credit to the original author(s) and the source, provide a link to the Creative Commons license and indicate if changes were made.

The images or other third party material in this chapter are included in the chapter's Creative Commons license, unless indicated otherwise in a credit line to the material. If material is not included in the chapter's Creative Commons license and your intended use is not permitted by statutory regulation or exceeds the permitted use, you will need to obtain permission directly from the copyright holder.





# An Empirical Investigation into Path Dependency and Embeddedness Among Sustainable Manufacturing Capabilities Envisaged in the Natural Resource-Based View of the Firm

Bhavya Pande<sup>(✉)</sup>, Gajendra Kumar Adil, Diksha Vashisht, and Sanchayan Mitra

Shailesh J Mehta School of Management, Indian Institute of Technology Bombay,  
Mumbai 400076, India  
bhavya.pande@som.iitb.ac.in

**Abstract.** The seminal and widely cited paper of Hart (1995) on the natural resource-based view of the firm, advocates that the source of competitive advantage in the imminent future will be rooted in emerging sustainable manufacturing capabilities. In order to understand how these capabilities, namely pollution prevention, product stewardship and sustainable development [clean technology] are acquired over period of time, Hart (1995) proposes two competing theories of path dependency and embeddedness. However, there is lack of empirical research on investigation of these two theories. The current study is undertaken to bridge this gap. The paper analyses the available sustainability reports of two multinational firms spanning across a number of years to derive insights on the validity of the two theories. The case observations reveal that the two theories in focus are not necessarily competing in nature but can coexist. The study adds theoretical insights to the literature and provides pointers towards future research directions in the field.

**Keywords:** Natural Resource Based View · Sustainable Manufacturing Capabilities · Sustainable Manufacturing Practices · Path Dependency · Embeddedness · Pollution Control · Pollution Prevention · Product Stewardship · Clean Technology

## 1 Introduction

Hart (1995) propounded the natural resource-based view (NRBV) of the firm using the argument that in the long run, businesses and markets will be constrained by and dependent upon the natural environment. Based on a firm's relationship to natural environment, three types of sustainable manufacturing (SM) capabilities are conceptualised within the NRBV framework: pollution prevention (PP), product stewardship (PS) and sustainable development [clean technology (CT)] (Hart, 1995; Hart and Dowell 2011). These capabilities are shaped by different driving forces and provide different competitive benefits

(Hart 1995; Hart and Dowell 2011; McDougall et al. 2019). Companies can employ pollution control (PC) besides PP for pollution abatement (Hart 1995). However, PC is a reactive approach which employs highly expensive, end of pipe solutions to arrest the generated effluents by a firm (Hart 1995; Baines et al. 2012). While, PP proactively aims at minimising the generation of emissions, effluents and waste through internal process improvements, resource conservation and provides a firm with low-cost competitive advantage in manufacturing (Hart 1995; Hart and Dowell 2011; Baines et al. 2012). PS considers the entire value chain to help lower the product's life cycle cost by enhancing its use productivity, recyclability, disassembly and disposability; thus, enables a firm to gain differentiation in the market (Hart 1995; Hart and Dowell 2011; Baines et al. 2012; McDougall et al. 2019). CT is attributed to breakthrough innovations in sustainable product and process design, that create disruption in the market (Hart and Milstein 2003). These are focussed on future positioning to provide first mover advantage to the firm (Hart and Dowell 2011). These four capabilities fall into a spectrum, in the order of PC, PP, PS and CT. PC is a reactive capability and other three are proactive with CT being the most proactive of the three (Hart 1997).

In order to understand how SM capabilities are built and specifically, their possible interconnections, Hart (1995) proposes two competing but paradoxical theories, namely, path dependency and embeddedness. Path dependency indicates sequential development of capabilities, on the contrary, embeddedness reveals concurrent development of capabilities. However, research on the practical existence of NRBV resources and capabilities in general and the interconnectedness of capabilities in particular is still in its infancy (McDougall et al. 2019). Fowler and Hope (2007), McDougall et al. (2019) and Shukla and Adil (2021) make noticeable attempt towards this. These papers conduct empirical investigation of SM capabilities through a case study of an outdoor apparel company, interviews with experts from the UK agri-food sector and a case study of a paint manufacturing company, respectively. The research findings reported in the above papers, provide support for embeddedness of SM capabilities but not for path dependency. What patterns emerge in other contexts still need to be researched to generalise such findings. The current study describes the research propositions of Hart (1995) in section two. Then in section three, it analyses sustainable manufacturing practices (SMPs) implemented by two multinational firms over a period of time to investigate if capability development shows a pattern of path dependency or embeddedness. Conclusions of the study are drawn in section four.

## 2 Research Propositions

Two theories of NRBV, viz., path dependency and embeddedness are described next.

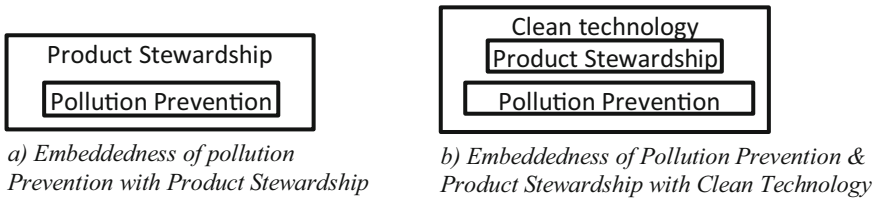
**Path Dependency:** Path dependency indicates that acquiring one capability becomes a pre-requisite for acquiring another (Hart 1995) and it demonstrates linear orchestration of resources (McDougall et al. 2019) (see Fig. 1).

Propositions on path-dependency (see Fig. 1) restated from Hart (1995) are: Proposition 1-PS is dependent upon a firm's prior capability in PP; Proposition 2-Development of CT is dependent upon a firm's capability in PP and PS.



**Fig. 1.** Path dependency of sustainable manufacturing capabilities (Adapted from Hart 1995).

**2.2 Embeddedness:** Embeddedness reveals that capabilities reinforce each other and are developed in parallel (Hart 1995; Fowler and Hope 2007) (see Fig. 2).



**Fig. 2.** Embeddedness of sustainable manufacturing capabilities (Adapted from Hart 1995).

Propositions on embeddedness restated below from Hart (1995) are: Proposition 3- PS facilitates and accelerates capability development in PP and vice versa (see Fig. 2a); Proposition 4- Development of CT facilitates and accelerates capability development in PP and PS and vice versa (see Fig. 2b).

### 3 Case Study

This section presents case studies of two manufacturing firms belonging to textiles and chemical industry, examining Hart's propositions on the interconnectedness of SM capabilities. Both the firms in this study are known for creating significant environmental impacts.

Mintzberg and Waters (1985) assert that the realised strategies in a firm are a product of its deliberate and emergent strategy. Accordingly, for the purpose of this study, implemented SMPs and those planned in future are treated as reflection of SM strategy of the case companies. The relevant data pertaining to SMPs are extracted from sustainability reports (Birla Cellulose, 2012–2021; Asian Paints 2014–2021). These SMPs are categorised into PC, PP, PS and CT as per their characteristics. Primarily, effluent treatment and discharge related SMPs were grouped under PC (see, Baines et al. 2012; Shukla and Adil 2021); SMPs employing continuous process improvements aimed at emission reduction, waste (hazardous and non-hazardous) minimisation and resource (energy, water and materials) conservation were grouped under PP (see, Rusinko 2007; McDougall et al. 2019); product life cycle design and management based SMPs were grouped under PS (see, Hart and Milstein 2003; Rusinko 2007). Further, SMPs involving breakthrough innovations in products and processes for which the firm claimed to have filed patents or be the first company in the industry to have implemented these or described as next generation solutions (implemented or planned) were grouped under CT

(see, Hart and Dowell 2011; McDougall et al. 2019). For each SMP, the first time it was reported is treated as the year of implementation. In case of future SMPs, planned year is treated as year of implementation in the analysis. Analysis of each case firm in two parts: (a) its SM capability development journey; and (b) interconnectedness between SM capabilities is presented next.

**3.1 Company A (Birla Cellulose):** The company is a leading producer of viscose staple fibres and other man-made cellulosic fibres in the global market. Data from available sustainability reports of the firm, covering the period between 2012–2021 (Birla Cellulose, 2012–2021), were extracted and analysed.

a) SM capability development journey

*Pollution Control:* Firm A's SMPs based on "end of pipe" method include: (a) installation of effluent treatment plant (ETP) for treatment of generated waste water and cooking chemicals to meet regulatory requirements; (b) reduction in waste sent to landfill and for incineration by selling the by-product of manufacturing as a raw material for other industrial applications; (c) reduction of colour in treated effluents through physio-chemical means to improve the waste water quality; (d) installation of reverse osmosis technology to recycle waste-water to reduce freshwater consumption and (e) becoming world's first cellulosic fibre manufacturer for implementing zero liquid discharge (ZLD) technology successfully and reaching a level of zero pollution load due to wastewater. It is to be noted that SMPs (b), (c) and (e) are sequentially developed and are undertaken to supplement SMP (a). Whereas SMPs (c) and (d) are developed in parallel. This shows traces of both path dependency and embeddedness of SMPs within the domain of PC itself.

*Pollution Prevention:* The firm has been proactively taking steps in waste minimisation and resource (energy, water and materials) conservation leading to significant reduction in generation of emissions. Through incremental process improvement towards emission reduction, the firm has achieved 37% reduction by the year of 2021 and 70% reduction is targeted by the year 2022, over the reference year of 2015. It is the first company in the man-made cellulosic fibre industry in the world, to have achieved carbon neutrality in scope 1 and scope 2 of greenhouse gas (GHG) emissions as per the GHG protocol corporate standard (Greenhouse Gas Protocol, no date). This is achieved through their sustained efforts in developing energy efficient processes, use of renewable energy and ensuring net growth of the forest cover managed by them. Going forward, the firm aims to achieve carbon neutrality in GHG protocol scope 3 standards by 2040. Notably, it has achieved incremental reduction in consumption of water, energy and materials through continuous process improvements along with the application of 4R principle of reduce, reuse, recycle and regenerate.

*Product stewardship:* The firm is a leader in PS initiatives in the man-made textile fibre industry as its products are made up of renewable forest based raw material, i.e., wood. It has been continuously innovating to create low emission and resource wise low impact products through sustainable product design and sustainable sourcing of wood and chemicals. For instance, Birla Spunshades dyed fibre is made using an advanced dyeing technique contributing to huge amounts of savings in water compared to conventional dyeing, and Liva Eco promises minimal use of water in comparison to other

natural fibres in its manufacturing process and significantly lowers GHG emissions. Similarly, Liva Sno, is produced using an eco-friendly whitening process which leads to no effluent generation, serving as an example where development of PS eliminates the need for PC. The firm recently launched a circular fibre made from pre-consumer cotton waste which offers the opportunity to upcycle the waste generated in the textile value chain. Procurement of 100% sustainably sourced wood and chemicals form a part of sustainable sourcing practices of the firm. Going further in the value chain, the firm plans to assess and improve the sustainability performance of its key suppliers by 2025.

*Clean technology:* The firm is committed towards R&D efforts and initiatives leading to create next generation solutions. It aims at developing products made with post-consumer textile waste and increased use of alternate feedstock by 2024.

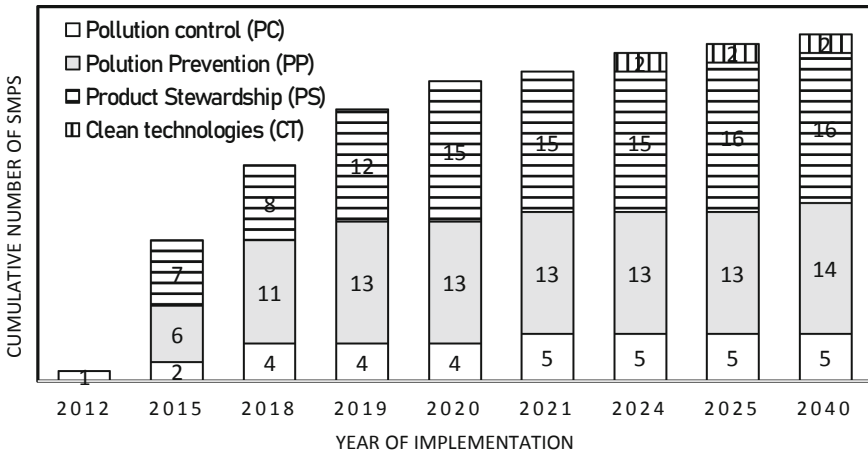


Fig. 3. Observed patterns of capability development in case company A

b) Interconnectedness between SM capabilities: The progress of case company A towards SM capability development has been charted in Fig. 3 by showing the cumulative number of SMPS within each category of PC, PP, PS or CT that are in place or planned over different time period (Birla Cellulose 2012–2021).

It can be observed from the figure that while one PC based SMP is in place in the year 2012, PP and PS based SMPs start later in 2015 and that on CT is planned for 2024. The figure also shows that starting with the year 2015 till date, SMPs in PC, PP and PS are being implemented in parallel. Further, it was found that deliberate PC efforts towards installing ZLD technology in 2021 have led to significant improvement in PP capability of the firm, specifically in resource conservation, enabling 95% recycling and reuse of waste-water within the manufacturing processes. This is an example of how PC reinforces PP (though PC is not included in the scope of Hart’s framework). Similarly, PS targeted SMPs involving the development of sustainable products also reinforce PP capability of the firm through use of renewable raw materials, process improvements, resource conservation and emission reduction. These findings provide

evidence in support of proposition 3 on embeddedness that PS facilitates and accelerates capability development in PP and vice versa. The firm has planned to implement CT-based initiatives much later in future, post attaining substantial PP and PS capabilities, which supports proposition 2 that adoption of CT has path dependency with PP and PS. Moreover, new SMPs of higher order capabilities are added sequentially in different time-periods within the individual domains of PC, PP and PS. The firm continues to implement all the types of SMPs till date, taking the total count from 1 in 2012 to 33 in 2021 with 2 CTs planned for 2024, 1 PS for 2025 and 1 PP for 2040. As significant efforts are directed towards acquiring higher order capabilities, it is likely that PC based SMPs will reach a saturation point in the coming years and eventually be eliminated. Thus, this case does not entirely support the proposition of path dependency or embeddedness but shows side by side existence of both.

**3.2 Company B (Asian Paints):** Asian paint ranks 1 in India, 3 in Asia and 9 in the world serving 60 countries and offering a wide range of paints for decorative and industrial use. Data spanning from sustainability reports available between 2014–2021 (Asian Paints, 2014-2021) for company B are studied.

a) SM capability development journey

*Pollution Control:* Initial SMPs of the firm involving PC include installation of ETPs, where raw effluents are treated to a level compliant with the pollution control board norms and treated wastewater is reused to the maximum extent possible within the company premises, in production processes, for landscaping/gardening or other domestic applications. Subsequently, starting from installing ZLD technology in few units in the year 2015, the firm achieved 100% installation in all its units by 2020. The observation on path dependency between installation of ETP and ZLD used for PC is similar to that of company A.

*Pollution Prevention:* Sequential transition from PC to PP is observed in firm B. Over the years, through significant efforts in hazardous waste minimisation, the firm has achieved 76% reduction in specific effluent generation in 2021 from the base year 2013–2014, thus minimising the burden on implementation of PC based SMPs. The supporting SMPs include implementation of ‘3R’ strategy of reduce, reuse and recycle for waste management and energy, material and water conservation practices.

*Product Stewardship:* Through simultaneous attention on sustainable sourcing of raw materials and packaging materials as well as on sustainable product design, the firm continues to be a leader in creating new, innovative and sustainable products. These products are energy efficient, are free from harmful chemicals, have increased renewable content, are non-polluting, improve indoor air quality, and are safe for humans and the environment.

*Clean Technology:* CT based SMPs of the firm represent breakthrough innovations in the paint industry, which includes, (a) development of an environment friendly and economically viable product, Genie polish which constitutes up to 84% renewable raw materials, promises superior labour productivity, and has no exposure related risk and consequent respiratory disease threat. This has helped the firm file two patents; (b) development of Royale Health Shield, an eco-friendly product that kills 99% of infection-causing bacteria- first and only paint in India that is recommended by Indian Medical

Association (IMA) and development of a paint named Nilaya Naturals which is earth-safe and formulated with over 95% materials of natural origin.

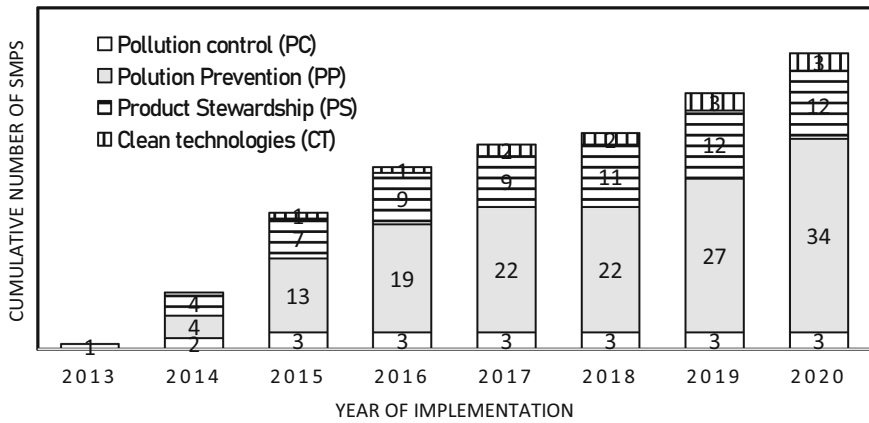


Fig. 4. Observed patterns of capability development in case company B

b) Interconnectedness between SM capabilities: Fig. 4 shows the cumulative number of SMPs that have been implemented or planned over different time period in company B. Like company A, it is observed that in company B, initiation of PC activities preceded that of PP and PS, both of which started in the year 2014 and CT in the year 2015. The observed data shows concurrent development of SMPs in PC, PP, PS and CT from the year 2015 to 2020. The findings of this case provide evidence of embeddedness in SM capabilities, showing support to proposition 3 and 4, that PS can accelerate implementation of SMPs in PP and vice versa and CT can facilitate and accelerate implementation of SMPs in PS and PP and vice-versa. It is also observed that there is minimum rise in the number of PC based SMPs (i.e., from 1 to 3) and maximum rise in the number of PP based SMPs (i.e., from 4 to 34) implemented between years 2014 and 2020.

## 4 Conclusion

This paper analysed data from two case companies to examine the theories of path dependency and embeddedness of SM capabilities as proposed by Hart (1995). The following conclusions can be drawn from this study. Path dependencies of SMPs were observed within a specific category (e.g., between SMPs of PC) as well as those belonging to different categories (e.g., PC and PP or PS and CT). However, path dependency where all SMPs of one category were implemented before the initiation of the first SMP in higher order categories of capabilities is not observed, suggesting that development of a higher order capability does not necessarily happen after a lower order capability is fully developed. There were many instances where SMPs were implemented in parallel from different capability categories showing the plausibility of embeddedness. Also, once implemented, none of the SMPs within any of the categories was discontinued. However,



their continuation gave only incremental improvement in environmental performance over the course of their journey. The findings of this study indicate that the theories of path dependency and embeddedness may not necessarily be competing in nature but can co-exist, thus differing from the previous research which provided support for embeddedness alone. This paper has analysed only two firms which is a major limitation for drawing general conclusions. Future empirical research on interconnectedness of SM capabilities may also explore the nature of interrelationships between different pairs of SMPs along with possible reasons. Further, characterisation of competitive value of SM capabilities offers another direction for research.

## References

- Baines, T., Brown, S., Benedettini, O., Ball, P.D.: Examining green production and its role within the competitive strategy of manufacturers. *J. Indust. Eng. Manag.* **5**, 53–87 (2012)
- Fowler, S.J., Hope, C.: Incorporating sustainable business practices into company strategy. *Bus. Strateg. Environ.* **16**(1), 26–38 (2007)
- Hart, S.L.: A natural-resource-based view of the firm. *Acad. Manag. Rev.* **20**(4), 986–1014 (1995)
- Hart, S.L.: Beyond greening: strategies for a sustainable world. *Harv. Bus. Rev.* **75**(1), 66–77 (1997)
- Hart, S.L., Milstein, M.B.: Creating sustainable value. *Acad. Manag. Perspect.* **17**(2), 56–67 (2003)
- Hart, S.L., Dowell, G.: Invited editorial: a natural-resource-based view of the firm: fifteen years after. *J. Manag.* **37**(5), 1464–1479 (2011)
- Mintzberg, H., Waters, J.A.: Of strategies, deliberate and emergent. *Strateg. Manag. J.* **6**(3), 257–272 (1985)
- McDougall, N., Wagner, B., MacBryde, J.: An empirical explanation of the natural-resource-based view of the firm. *Prod. Plan. Control* **30**(16), 1366–1382 (2019)
- Rusinko, C.: Green manufacturing: an evaluation of environmentally sustainable manufacturing practices and their impact on competitive outcomes. *IEEE Trans. Eng. Manage.* **54**(3), 445–454 (2007)
- Shukla, G.P., Adil, G.K.: A conceptual four-stage maturity model of a firm's green manufacturing technology alternatives and performance measures. *J. Manuf. Technol. Manag.* **32**(7), 1444–1465 (2021)
- Birla Cellulose Sustainability report (2012–2021). [online]<https://www.birlacellulose.com/>. Accessed 2 May 2022
- Asian Paints (2014–2021). Sustainability report. [online]. <https://www.asianpaints.com/>. Accessed 2 May 2022
- Greenhouse Gas Protocol (no date). [online]. <https://ghgprotocol.org/standards/>. Accessed 2 May 2022

**Open Access** This chapter is licensed under the terms of the Creative Commons Attribution 4.0 International License (<http://creativecommons.org/licenses/by/4.0/>), which permits use, sharing, adaptation, distribution and reproduction in any medium or format, as long as you give appropriate credit to the original author(s) and the source, provide a link to the Creative Commons license and indicate if changes were made.

The images or other third party material in this chapter are included in the chapter's Creative Commons license, unless indicated otherwise in a credit line to the material. If material is not included in the chapter's Creative Commons license and your intended use is not permitted by statutory regulation or exceeds the permitted use, you will need to obtain permission directly from the copyright holder.





# Empirical Investigation of Climate Neutrality Strategies of Companies in Industrial Production

Stefan Seyfried<sup>(✉)</sup>, Lukas Nagel, and Matthias Weigold

Institute of Production Management, Technology and Machine Tools (PTW),  
Technical University of Darmstadt, Otto-Berndt-Street 2, 64287 Darmstadt, Germany  
s.seyfried@ptw.tu-darmstadt.de

**Abstract.** The goal of climate neutrality gains importance in the strategic focus of companies. When it comes to strategies for climate neutral production, different companies pursue a variety of approaches. These range from pure compensation approaches to the complete replacement of fossil energy sources. As part of an empirical study, the approaches toward climate neutrality of 50 companies were analyzed. Both small and medium-sized enterprises (SMEs) and large companies were included in the study. Differences already arise from a different understanding of the term climate neutrality. Accordingly, the strategic approaches also differ, both regarding the definition of goals and regarding the specification of a roadmap for achieving those goals. The article presents the results of the empirical study and systematizes the findings.

**Keywords:** Climate strategies · sustainability · industrial production

## 1 Introduction

Limiting global warming to a maximum of 2 °C and, if possible, keeping it below 1.5 °C is considered a central goal in mitigating the consequences of climate change and is a core component of international climate agreements such as the Paris Climate Agreement [1], which has recently been reaffirmed at COP26 [2]. Manufacturing companies still significantly contribute to climate change through their greenhouse gas emissions [3]. In the industrial sector, in particular, emissions have stagnated over the past twenty years [4].

However, the long-term goal is to achieve climate neutrality. This is more and more reflected in the strategies of companies, which often define sustainability strategies and climate strategies [5]. Both, large companies and SMEs, frequently set themselves the goal of climate neutrality. In addition to ecological motivations, economic incentives such as rising energy costs, a CO<sub>2</sub> price and progressive regulation through legal requirements and the demand of customers and investors for sustainably produced goods are incorporated as decisive factors [6].

## 2 State of the Art

In science, politics and in the context of corporate publications, the term climate neutrality is used with increasing frequency [7]. Companies are aligning goals and strategies accordingly and declaring products, corporate divisions or the entire company to be climate neutral. However, interpretations of the term often differ and are mixed with CO<sub>2</sub> neutrality and greenhouse gas neutrality [8]. But not all these terms describe the same impact on the climate:

CO<sub>2</sub> neutrality qua term includes only carbon dioxide. In the sense of a complete mitigation of all harmful impacts on the climate system, CO<sub>2</sub> neutrality thus represents only a partial goal. Greenhouse gas neutrality includes other greenhouse gases in addition to CO<sub>2</sub>. The term climate neutrality goes beyond the mere avoidance of greenhouse gas emissions. Anthropogenic activities have no net impact on the climate system in this state. Thus, the state of climate neutrality represents the most ambitious climate protection goal [8, 9].

The path to climate neutrality currently presents itself as an enormous challenge for manufacturing companies [10]. In the literature, there is so far no uniform strategy for achieving climate neutrality. Typical steps that must be taken on the way to climate neutrality are accounting, minimization, substitution, offsetting and communication [11, 12].

Although many companies agree on the basic goal of climate-neutral production, they choose different approaches to achieve this goal. Strategy implementation often depends on offsetting approaches rather than the complete elimination of greenhouse gas emissions during the production process [13]. Companies also differ in their choice of accounting boundaries. For example, only direct emissions of scopes 1 and 2 according to the Greenhouse Gas Protocol (GHG) are considered, while the often even larger, but more difficult to quantify, indirect emissions of scope 3 are not considered [14, 15].

This article takes these differences as an impulse to analyze in more detail, based on empirical data, how companies approach the goal of climate neutrality strategically. The results of the empirical study are described below.

## 3 Methodology

Based on the state of the art and known research results, the objective of this paper is to enhance these findings with empirical data on the implementation of climate strategies from corporate practice. To this end, a questionnaire was sent electronically to 900 individuals from the management board, production-related management (e.g. production manager) or individuals responsible for the field of sustainability at their respective company. All companies are located in Germany. The empirical data collection follows the mixed methods approach [16] and combines quantitative and qualitative research elements. The questionnaire contains both closed questions for direct quantitative evaluation and open questions where the answers were codified and categorized for quantitative evaluation. The responses to the open questions were also analyzed qualitatively to consider information provided by individual respondents. The questions are derived from evaluating the scientific state of the art. They cover the topics of the company's strategic

orientation, the status in the transformation towards climate neutrality by means of a simple maturity model, specific questions on certain measures and associated implementation barriers, and motivators for the company's strategic orientation in the context of climate change. The scope of the questionnaire is limited to seven questions to ensure a high response rate and, at the same time, sufficient substance of the results.

## 4 Results

The cross-sector survey is used to develop and map the viewpoint of manufacturing companies in the context of climate neutrality strategies. The evaluation includes responses from 55 people from 50 different companies. 21.8% of the participants come from large companies, 56.4% from medium-sized companies and 5.5% from small companies. For 16.4%, no company size was given.

**Question 1: Definition of Climate Neutrality.** The free text question for a definition of climate neutrality is met with a diversified response pattern. The inconsistent definition in the literature is reflected in the results. Only 23.6% of the participants refer in their answer to the influence of emissions on the entire climate system and thus follow the definition of the Intergovernmental Panel on Climate Change (IPCC) [9]. In contrast, 18.2% refer to greenhouse gas emissions, and the majority (36.4%) associate the term climate neutrality with the consideration of CO<sub>2</sub> emissions (see Fig. 1).

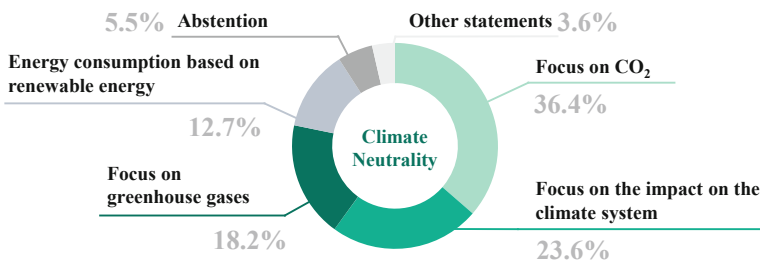


Fig. 1. Question 1: Definition of climate neutrality

**Question 2: Importance of Climate Neutrality.** Almost half of the participants state that they have firmly anchored the topic in their corporate strategy. In 56% of the participating companies, there is a working group that explicitly deals with climate neutrality. The consideration of emissions in investment decisions and the provision of a catalog of measures is less widespread but is considered a planned long-term measure by around one-third of the respondents (see Fig. 2).

**Question 3: Strategies for Climate Neutrality.** Over 70% of respondents indicate that their company has or plans to establish a strategy for carbon neutrality in Scopes 1 & 2.

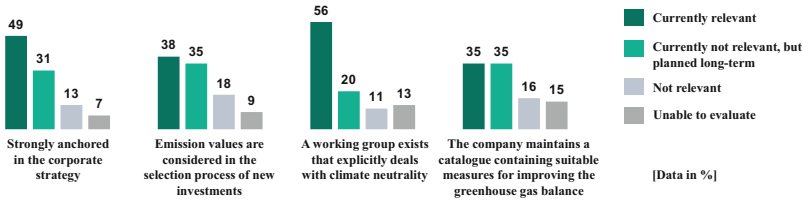


Fig. 2. Question 2: Importance of climate neutrality

When Scope 3 is included, this proportion is reduced to barely half of the companies, with only 10.9% having already defined such a strategy. None of the surveyed companies currently achieves climate neutrality regarding Scope 3. Also, in relation to Scope 1 and 2, only 3.6% state that they have already achieved this goal (see Fig. 3).

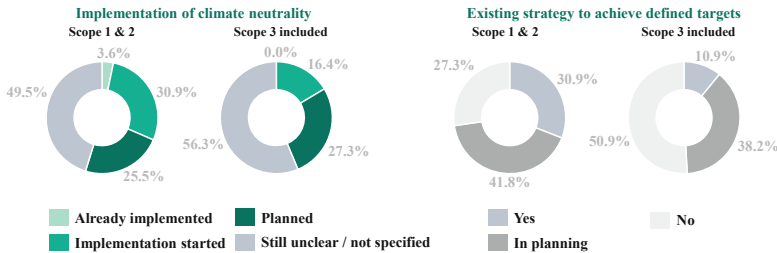


Fig. 3. Question 3: Strategies for climate neutrality

**Question 4: Maturity Level for the Transformation Towards Climate Neutrality.**

To determine the status of the transformation towards climate neutrality, the survey uses a simple maturity model with the following three maturity levels: Maturity level 1 is characterized by little know-how on the topic of climate neutrality, a missing strategic approach for climate neutrality, no clear responsibilities in the organization and hardly any data on emission values of the company. At maturity level 2 various areas of the company are already climate-neutral or on the way to becoming climate-neutral; there are several people/working groups in the company who are actively working on the issue and there are data on emission values for individual areas of the company. Maturity level 3 expects the company to be working towards climate neutrality, characterized by a low offsetting rate through emission certificates. Scopes 1 & 2 have to be already climate neutral and the company has to be engaged in emission reduction of its value chain (scope 3). 31% of the respondents assign their company to the lowest maturity level 1, 55% maturity level 2 and only 14% see their company at the most advanced maturity level 3.

**Question 5: Relevance of Mitigation Measures and Barriers.** To gain an insight into the operationalization of the strategies, the relevance of specific fields of action for the

individual companies was surveyed. The survey also asked about barriers to implementation. Figure 4 shows the results for measures that can be classified as minimization measures.

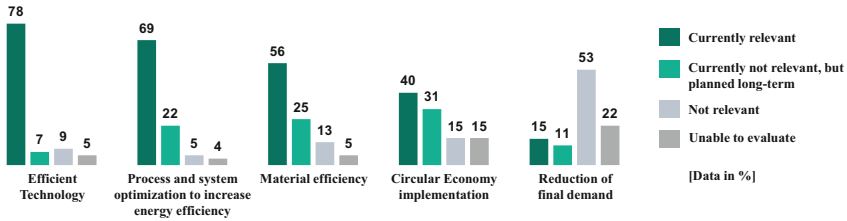


Fig. 4. Question 5: Relevance of mitigation measures – minimization

The application of energy-efficient technologies and increasing energy efficiency through process optimization are of high importance in this context. Material efficiency measures are currently relevant for 56% of the participants. The introduction of a circular economy is currently a relevant measure for reducing emissions by only 40%. 15% do not consider the conversion of the linear value chain to a circular system to be relevant and another 15% cannot assess the relevance. Reducing final demand is only relevant for a total of 26%, either currently or in the longer term. Barriers to implementing minimization measures arise mainly from costs or lack of resources.

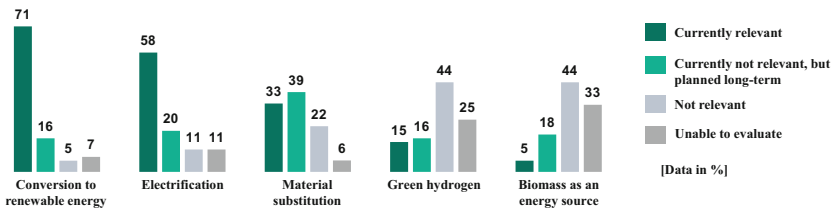


Fig. 5. Question 5: Relevance of mitigation measures – substitution

Figure 5 represents the area of substitution. This is characterized by the focus on the switch to renewable energies. For only 5% this is not relevant. Electrification as part of the conversion to renewable energies is clearly more relevant than the use of green hydrogen or biomass as an energy source. Measures with currently low availability are not yet in the focus of the companies, and their application tends to be more difficult to assess. Economic reasons are most frequently cited as a barrier to the switch to renewable energies. Substitution of materials is constricted by a lack of material alternatives, special material requirements and customer requirements.

The area of offsetting is illustrated in Fig. 6. The results for the purchase of emission certificates reflect current debates about its effectiveness as a climate protection measure. The relevance is disputed among the participants. When asked about obstacles to implementation, 19.6% say they consider the measure unsustainable or greenwashing.

On the other hand, 53% of the companies want to offset emissions with internal climate protection projects, and another 22% are planning their own long-term internal offset projects. Compared to the purchase of certificates, companies tend to favor internal off-setting projects. For most companies, Carbon Capture and Storage (CCS) and Carbon Capture and Usage (CCU) technologies are not relevant or cannot be evaluated yet.

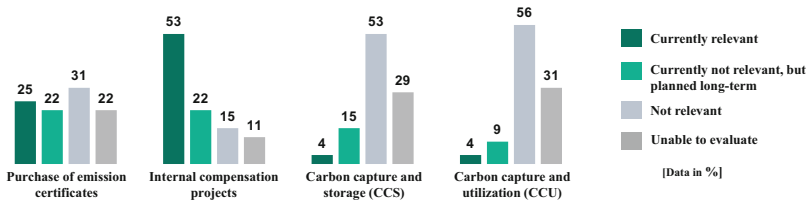


Fig. 6. Question 5: Relevance of mitigation measures – offsetting

**Question 6: Offsetting Strategies.** The complex and controversial societal debate about the actual benefits of emission certificates is addressed in the survey from a company perspective. For 63.6% of the participating companies, offsetting through certificates is only a temporary measure on the way to climate neutrality. 14.5% of the participants consider certificates to be greenwashing. The transparency of the certificate market is also questioned. The actual environmental impact behind an offsetting strategy seems to be an important aspect for most companies (see Fig. 7).

**Question 7: Motivation.** Motivational reasons for climate protection measures were asked for in a free text field and then classified. Social responsibility towards society and family (32.2%) and environmental protection (30.4%) were identified as important drivers. These were followed by legal requirements, competitive advantages and customer requirements, each accounting for a similar proportion of around 10%.

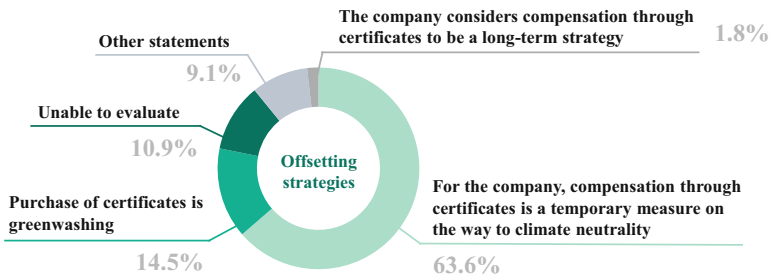


Fig. 7. Question 6: Offsetting strategies



## 5 Discussion

The study gives insights into the transformation of companies towards climate neutrality. Although 50 German companies have been surveyed, the results should not necessarily be considered representative for the German industry, but they provide valuable insights into a sample of companies of various sizes and from various industrial sectors. The surveyed companies have recognized the importance of climate neutrality in many cases. They are driven by various motivators which can be attributed primarily to the area of corporate responsibility. However, it can be assumed that extrinsic factors such as public expectations also exert an influence on the companies. On an abstract level, the majority of companies state that they take the goal of climate neutrality into account strategically. This high priority is somewhat at odds with the results of the question about a definition of climate neutrality. It is assumed from the responses that there is not yet a uniform understanding of the term. However, to ensure the comparability of communicated goals of companies, uniform definitions are necessary. It is observed that hardly any companies have implemented the goal of climate neutrality to date. Even if climate neutrality strategies are specified, the results fall short of the fundamental importance attributed to the topic. This becomes particularly clear when Scope 3 is considered in addition to Scope 1 and 2. Not only does no company currently meet the goal of climate neutrality at Scope 3, but many companies also lack strategies and measures to pursue and achieve this goal in the long term. This is particularly remarkable because a large proportion of a company's emissions frequently falls within Scope 3 [14]. Consequently, only 14% indicate the highest suggested maturity level 3. While topics such as energy efficiency, material efficiency, the shift to renewable energies and electrification are perceived as highly relevant, approaches such as circular economy and material substitution still lack approval. It is notable that, contrary to the public debate, alternative energy sources such as hydrogen and biomass are accorded only minor importance. Reasons for this are assumed to be the lower technical availability and a strong dependence on specific industries. The study indicates that offsetting measures currently account for a significant proportion of companies' efforts to achieve climate neutrality. However, a large proportion of companies also state that they regard this as a temporary transitional solution. This means that even greater technical efforts will be required in the future. In the opinion of the companies surveyed, however, these measures do not belong to CCS and CCU. It is therefore clear that decarbonization of the production processes themselves will become unavoidable.

## 6 Conclusion

The empirical study shows that most surveyed companies are conscious of the strategic goal of climate neutrality. But there is still a lack of transfer of the abstract strategic goal into operations. One reason can be seen in the lack of specification of the term climate neutrality for the corporate level. Today, many companies approach the goal with offsetting projects, but even the companies themselves do not consider these to be effective in the long term. There is a need for further research and support for companies on the question of how climate neutrality can be defined for companies and how this

goal can be implemented strategically and operationally without offsetting projects. Conducting a subsequent study with a larger sample of companies should be considered to ascertain that the results are representative for the German industry. Another survey with a larger sample could also facilitate research on how factors such as the industrial sector, company size or other qualitative characteristics of a company's organization are linked to their transformation towards climate neutrality.

## References

1. United Nations, 2015. Paris Agreement, Paris. [http://unfccc.int/files/meetings/paris\\_nov\\_2015/application/pdf/paris\\_agreement\\_english\\_.pdf](http://unfccc.int/files/meetings/paris_nov_2015/application/pdf/paris_agreement_english_.pdf). Accessed 5 Dec 2021
2. United Nations, 2021. Glasgow Climate Pact, Glasgow. [https://unfccc.int/sites/default/files/resource/cop26\\_auv\\_2f\\_cover\\_decision.pdf](https://unfccc.int/sites/default/files/resource/cop26_auv_2f_cover_decision.pdf). Accessed 7 Dec 2021
3. European Commission, 2019. The European Green Deal, Brussels. <https://eur-lex.europa.eu/legal-content/EN/TXT/?uri=COM:2019:640:FIN>. Accessed 1 Dec 2021
4. Boston Consulting Group, 2021. Klimapfade 2.0: Ein Wirtschaftsprogramm für Klima und Zukunft. <https://web-assets.bcg.com/58/57/2042392542079ff8c9ee2cb74278/klimapfade-study-german.pdf>. Accessed 22 April 2022
5. Choi, J.-K., Schuessler, R., Ising, M., Kelley, D., Kissock, K.: A pathway towards sustainable manufacturing for mid-size manufacturers. *Procedia CIRP* **69**, 230–235 (2018)
6. Buettner, S.M., König, W.: Looking behind decarbonisation - What pressure points trigger action? In: ECEEE Summer Study Proceedings, Stockholm, pp. 345–354 (2021)
7. Müller, E.: Kompensation und Klimaneutralität - Königsweg zum Klimaschutz? *GAIA – Ecol. Perspect. for Sci. Soc.* **29**(1), 16–20 (2020)
8. Honegger, M., Schäfer, S., Poralla, P., Michaelowa, A.: Dena-analyse: Klimaneutralität: Ein Konzept mit weitreichenden Implikationen, Berlin (2020). [https://www.dena.de/fileadmin/dena/Publikationen/PDFs/2020/dena\\_BR\\_Analyse-Klimaneutralita\\_\\_t\\_WEB.pdf](https://www.dena.de/fileadmin/dena/Publikationen/PDFs/2020/dena_BR_Analyse-Klimaneutralita__t_WEB.pdf). Accessed 25 Apr 2022
9. Intergovernmental panel on climate change (IPCC), Global Warming of 1.5°C: Annex I: Glossary (2018). [https://www.ipcc.ch/site/assets/uploads/sites/2/2019/06/SR15\\_AnnexI\\_Glossary.pdf](https://www.ipcc.ch/site/assets/uploads/sites/2/2019/06/SR15_AnnexI_Glossary.pdf). Accessed 16 May 2022
10. Wuppertal Institut, CO<sub>2</sub>-neutral bis 2035: Eckpunkte eines deutschen Beitrags zur Einhaltung der 1,5-°C-Grenze new, Wuppertal (2020). [https://epub.wupperinst.org/frontdoor/deliver/index/docId/7606/file/7606\\_CO2-neutral\\_2035.pdf](https://epub.wupperinst.org/frontdoor/deliver/index/docId/7606/file/7606_CO2-neutral_2035.pdf). Accessed 2 May 2022
11. Bode, S., Lüdeke, F.: CO<sub>2</sub>-neutrales Unternehmen - was ist das? *uwf UmweltWirtschafts-Forum* **15**(4), 265–273 (2007)
12. Hannen, C.: Transformationsstrategien zum CO<sub>2</sub>-neutralen Unternehmen: Unternehmen im Kontext von Klimawandel und nationalen Klimaschutzziele. Dissertation, Kassel (2021)
13. Day, T., et al.: Corporate climate responsibility monitor 2022, Berlin (2022). <https://newclimate.org/wp-content/uploads/2022/02/CorporateClimateResponsibilityMonitor2022.pdf>. Accessed 2 May 2022
14. Schmidt, M., Nill, M., Scholz, J.: The relevance of the supply chain for the climate footprint of companies. *Chem. Ing. Tec.* **93**(11), 1692–1706 (2021)
15. World Resources Institute, The Greenhouse Gas Protocol: A Corporate Accounting and Reporting Standard, Washington (2015). <https://ghgprotocol.org/sites/default/files/standards/ghg-protocol-revised.pdf>. Accessed 1 Dec 2021
16. Liebig, S., Wenzel, M., Rosenbohm, S.: *Handbuch Empirische Organisationsforschung*. Springer Fachmedien, Wiesbaden (2017). <https://doi.org/10.1007/978-3-658-08493-6>

**Open Access** This chapter is licensed under the terms of the Creative Commons Attribution 4.0 International License (<http://creativecommons.org/licenses/by/4.0/>), which permits use, sharing, adaptation, distribution and reproduction in any medium or format, as long as you give appropriate credit to the original author(s) and the source, provide a link to the Creative Commons license and indicate if changes were made.

The images or other third party material in this chapter are included in the chapter's Creative Commons license, unless indicated otherwise in a credit line to the material. If material is not included in the chapter's Creative Commons license and your intended use is not permitted by statutory regulation or exceeds the permitted use, you will need to obtain permission directly from the copyright holder.





# Developing a Manufacturing Process Level Framework for Green Strategies KPIs Handling

Vasiliki C. Panagiotopoulou , Alexios Papacharalampopoulos,  
and Panagiotis Stavropoulos<sup>(✉)</sup> 

Laboratory for Manufacturing Systems and Automation, University of Patras, 26504 Patras,  
Greece

pstavr@lms.mech.upatras.gr

**Abstract.** Green strategies in manufacturing have multifold perspectives implying that are highly diversified in terms of resources management. Popular green strategies are Zero Defect, Circularity and Sustainability. The challenges regarding resources efficiency result from different concepts addressed by each strategy; Zero Defect focuses on defect prevention via quality planning, control, and improvement, while Circularity addresses resources optimisation via resources management, material production, usage and disposal. Sustainability is a different approach, to include economic growth and social impact, besides resources management, waste management and environmental impact. Until now, key performance indicators (KPIs) have been used for individual strategy, while literature shows a lack of frameworks towards transforming KPIs when adopting more than one strategy. The current work is a step towards defining an approach describing the relationship between the KPIs of different green strategies and elaborating the repercussions of this transformation on workflows and specifically on manufacturing processes. Two different approaches could be used (monetary and qualitative) with thermoforming used as a case, and the results are indicative of the method efficiency, where KPIs for Zero Defect, Circularity and Sustainability are compared. The framework is developed to be later generalised and applied to other manufacturing processes.

**Keywords:** KPIs · Green Strategies · Zero Defect Manufacturing · Circularity · Sustainability

## 1 Introduction

Manufacturing is heavily contributing to carbon emissions in Europe, being the second top contributor behind the energy sector. Since EU has developed a roadmap to gradually decrease its carbon emissions until becoming the first carbon neutral continent by 2050 (Green Deal), the industrial sector has to keep up with massively reducing its energy consumption and carbon footprint [1, 2], to contribute to this initiative. Several green strategies have been developed over the last few decades but in this work, the focus is on zero defect manufacturing, circular economy and sustainability since these strategies have been extensively developed and are trending approaches in innovation and industry.

© The Author(s) 2023

H. Kohl et al. (Eds.): GCSM 2022, LNME, pp. 1008–1015, 2023.

[https://doi.org/10.1007/978-3-031-28839-5\\_112](https://doi.org/10.1007/978-3-031-28839-5_112)

Zero Defect Manufacturing is the extension of the widely adopted 6-sigma approach, focusing on eliminating the number of defect products [3], while approaches focusing on circularity aim to transform linear economy currently used (production, use, disposal) into a circular economy where products are reused, recycled and repurposed [4]. Sustainability is a more general approach, focusing on planet, people and economics, in order to provide the best solutions with low environmental impact, taking into consideration the welfare of workforce and society and ensuring profit for companies [5].

Literature search regarding reported KPIs (Table 1) on zero defect manufacturing (ZDM), circular economy (CE) and sustainability (S) was performed, with the most commonly used KPIs summarized in the following table. KPIs are categorized in three main categories: 1) environmental, where use, waste and emissions are included, 2) financial, where quality, cost, delivery and flexibility are included and 3) social, where community, employees and suppliers are included. The main limitation was that these KPIs were solely used for the purpose of a single green strategy, without defining what may be the impact of one KPI if used in additional strategies, which may well be contradictory from one green strategy to another. Current work is aiming to develop and propose a framework on the relationship between KPIs for green strategies.

**Table 1.** List of KPIs per category ( environmental, financial and social aspects) and allocated per green strategy (zero defect manufacturing- ZDM, circular economy-CE, sustainability-S)

Categories	KPIs	ZDM	CE	S
Environmental	Material consumption [6, 7, 8, 9]		X	X
	Water consumption [7, 8, 10]		X	X
	Energy consumption [6, 7, 8, 10, 11]		X	X
	Use of renewable energy [7]		X	
	Energy efficiency [7]		X	
	Increase recycling rate [6, 9]		X	
	Waste generated [6, 10]		X	X
	Reduce carbon emissions [9, 11, 12]		X	X
	Reduce disassembly time [9]		X	
	Fuel consumption [8, 11, 12]			X
	Water and land emissions [12]			X
	Wastewater [10, 12]			X
Financial	Parts per month [13]	X		
	Tardiness [14, 15]	X		
	Defects ratio [15, 12]	X		
	Scrap and Rework [16, 12]	X		X
	Average production cost [14, 15]	X	X	X
	Delay cost [14, 15, 7, 8, 11]	X	X	X
	Final unit cost [15]	X		

(continued)

**Table 1.** (continued)

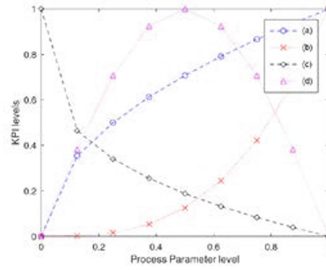
Categories	KPIs	ZDM	CE	S
	Maintenance cost [15]	X		
	Learning cost [7]		X	
	Inventory cost [8, 11]			X
	Product reliability and durability [12]			X
	Overhead cost [12]			X
	Cycle time and flexibility [12]			X
	New product development [12]			X
Social	Occupational health & safety[8, 11, 12]			X
	Training and education [8, 11, 12]			X
	Job satisfaction and salary level [12, 10]			X
	Supplier certification &commitment [12]			X
	Gender equity [8]			X
	Benefits/commission/profit [10]			X
	Society and Human rights[17]			X

## 2 Framework

There are in principle two main approaches towards comparing the effect on adopted strategies on resulting optimization. The first one would be to compare everything in terms of monetary units. However, this would require elaborated financial models [18]. Herein, an alternative way of achieving this is attempted, taking advantage of a qualitative comparison. This qualitative approach proposed aims to identify the correlation between the different KPIs of the most used green strategies. This framework starts off with identifying (1) the manufacturing process that will be used as a case, (2) the materials that will be used as an input and (3) the final product. The selection of the above-mentioned parameters will dictate the parameters that will be used in the process. Then, the relevant KPIs per green strategy will be selected, ideally using a database such as Table 1. Following the KPI selection, the process parameters that are impacting the KPIs will be defined, followed by the determination of the relations between parameters and KPIs. The ultimate objective is to check whether all the KPIs, in pairs, have a good correlation. Equivalently, the change of the KPIs with the modification of the Process Parameters has to be of the same trend (monotonicity). If this is the case, then the strategies can be used interchangeably, as in the case 1 of Fig. 1, where an exemplary schematic is presented with different relationship types between KPIs and their respective process parameter level.

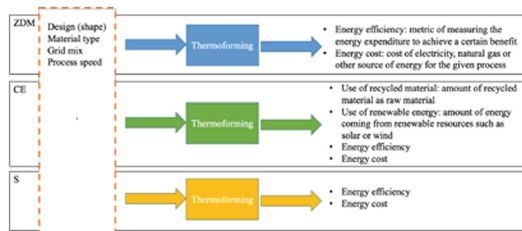
## 3 Case Study

In this paper, thermoforming of low density polyethylene into a hemispherical shell was used as a case study. Data were collected from a template case study consisting of



**Fig. 1.** KPIs relations: Case 1 - (a) and (b), Case 2 - (a) and (c), Case 3 - (a) and (d).

a single process with process speed being estimated at 140 s, with 60 kWh for a full hour operation of the thermoforming equipment. The material used for the production of bowl was either raw low density polyethylene ( $0.88\text{g/cm}^3$ ) or recycled polyethylene. The final product would have been a hemispherical shell, of 5 cm external radius and 4.5cm internal radius. Values for the respective parameters were calculated from the previously described process parameters. The green strategies used for this case study were zero defect manufacturing, circular economy and sustainability, with the main KPIs found in Fig. 2.



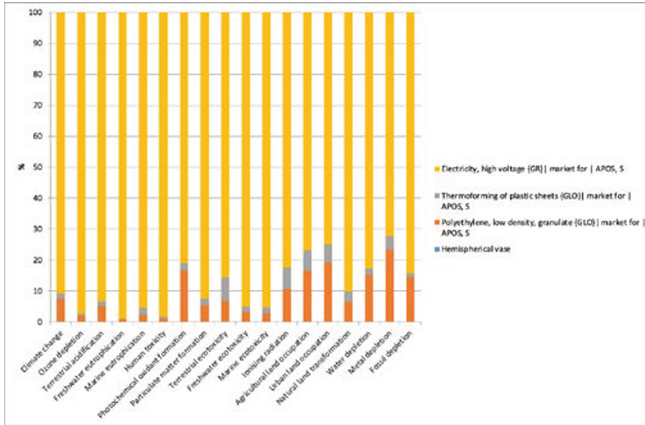
**Fig. 2.** Relevant process parameters (left) that affect KPIs (right) per green strategy.

### 4 Results

Thermoforming was used as an example because of its great environmental impact, the majority of which derives from the use of electricity, as shown in Fig. 3. The environmental impact of thermoforming was calculated from SimaPro 9.3.03 and Ecoinvent Database 3.1.

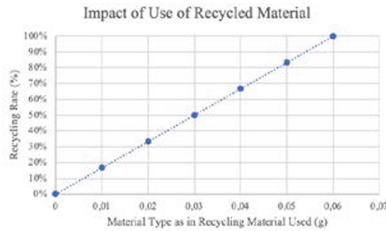
In the qualitative approach, the relationship between the process related parameters and the KPIs were investigated, determining a relationship between the following pairs:

1. Material type used (mass of recycling material as raw material) and recycling rate: applicable pair for circular economy, showing a linear relationship (Fig. 4)
2. Design as in shape and mass of material used and energy efficiency: pair applicable to sustainability, showing an exponential relationship, with energy efficiency decreasing as the mass of raw material increased (Fig. 5)

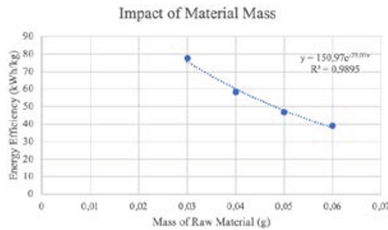


**Fig. 3.** Environmental impact of thermoforming after performing LCA using SimaPro, in categories such as climate change (carbon footprint and more), human toxicity, fresh water, marine ecology.

3. Percentage of renewable energy used and energy cost: pair applicable to sustainability. The relationship though is not linear for all types of renewable sources due to high differences in value of different energy mixes (Fig. 6)
4. Process speed and energy efficiency: a pair applicable to all three green strategies, without a linear relationship since energy efficiency for thermoforming depends on both power of thermoforming and mass of material to be thermoformed (Fig. 7)



**Fig. 4.** Impact of use of recycled material on the recycling rate.



**Fig. 5.** Impact of raw material mass on the energy efficiency.



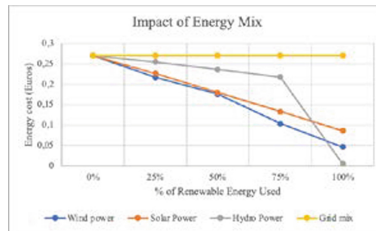


Fig. 6. Impact of energy mix on the energy cost in euros.

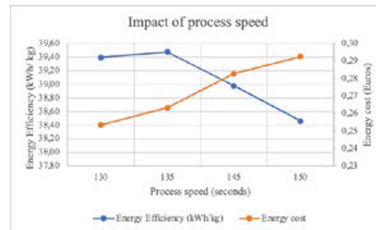


Fig. 7. Impact of process speed on the energy efficiency and the energy cost.

## 5 Discussion

This study has shown that the relationship between process parameters and KPIs in green strategies is not a straightforward and monotonous relationship for all cases, but it is rather determined by the selection of values per process parameters. This highlights the difficulty in harmonizing the KPIs in order to address multiple green strategies at the same time using unified approaches for process parameters optimization.

Design, in terms of shape or material weight, affects energy efficiency of thermoforming. However, this particular process is often disregarded when zero defect manufacturing is the green strategy of choice, but it is used for sustainability approaches where redesign using fewer resources is a key approach. The applicability of this parameter is not discussed in zero defect manufacturing despite its potential impact on the product being conformed with certain specifications. Similarly, using fewer resources should be linked to circular economy, but this relationship should follow the one described in this case. The type of material used, and especially the use of a percentage of recycled material instead of completely raw material, is often associated with circular economy as an approach to reuse, recycle and repurpose products. This, however, may have an impact on the features of the final product, as recycled material may not have the same properties as raw materials due to them being already processed and used in previous applications. Renewable energy used is linked to sustainability, as an effort to move from fossil based energy to renewable types of energy, such as wind, solar and hydropower. The relationship between percentage of renewable energy used and energy cost is not linear, and it is uncertain how this relationship is translated in the case where either circular economy or zero defect manufacturing is the green strategy of choice. Process speed is a process parameter related to zero defect manufacturing as a valuable parameter related to the quality of the final product and the defects ratio. However, an optimal value for process speed should be defined in order to have the best quality of the final product and the small number of defected products. In the case of circular economy and sustainability,

increased process speed means increased energy consumption and cost, and potentially impacting workforce.

The main limitation of this framework is the fact that its applicability to other cases has been investigated. In addition, it has not been considered to use a weighted version of framework to include all aspects (environmental, financial and social KPIs). Greens strategies.

## 6 Conclusions and Future Outlook

Developing a framework to identify the relationship between process parameters and KPIs per green strategy has suggested that the relationship is far more complicated than thought, while extrapolating from one green strategy to another is not a straightforward process. The three different strategies have a different focus, with ZDM focusing on part performance, CE on resources efficiency and S on perpetuality of profit; often all these are being contradictive, albeit occasionally they all imply environmental constraint. Each green strategy has its own KPIs, and its own relationship between process parameters and KPIs, often contradictory, or worse; of different trend, between the different strategies.

Future work should focus on identifying the exact relationship between the different green strategies and their KPIs. In addition, the unification of the green strategies needs to be addressed, potentially through a hierarchical approach, taking into account the different cases of design and operation.

**Acknowledgements.** This work is under the framework of EU Project AVANGARD, receiving funding from the European Union's Horizon 2020 research and innovation program (869986). The dissemination of results herein reflects only the authors' view and the Commission is not responsible for any use that may be made of the information it contains.

## References

1. Panagiotopoulou, V.C., Stavropoulos, P., Chryssolouris, G.: A critical review on the environmental impact of manufacturing: a holistic perspective. *Int. J. Adv. Manuf. Technol.* **118**(1–2), 603–625 (2021). <https://doi.org/10.1007/s00170-021-07980-w>
2. Stavropoulos, P., Panagiotopoulou, V.C., Papacharalampopoulos, A., Aivaliotis, P., Georgopoulos, D., Smyrniotakis, K.: A framework for CO2 emission reduction in manufacturing industries: a steel industry case. *Designs (Basel)* **6**(2), 22 (2022)
3. Papacharalampopoulos, A., Stavropoulos, P., Petrides, D.: Towards a digital twin for manufacturing processes: applicability on laser welding. *Procedia Cirp* **88**, 110–115 (2020)
4. Sassanelli, C., Rosa, P., Rocca, R., Terzi, S.: Circular economy performance assessment methods: a systematic literature review. *J. Clean. Prod.* **229**, 440–453 (2019)
5. Fysikopoulos, A., Alexopoulos, T., Pastras, G., Stavropoulos, P., Chryssolouris, G.: On the design of a sustainable production line: the MetaCAM tool. In: *ASME International Mechanical Engineering Congress and Exposition*, vol. 57588, p. V015T19A015 (2015)
6. Ahlers, R.: The life cycle performance assessment (LCPA) methodology. In: Rosa, P., Terzi, S. (eds.) *New Business Models for the Reuse of Secondary Resources from WEEE*s. Springer-Briefs in Applied Sciences and Technology, pp. 81–96. Springer, Cham (2021). [https://doi.org/10.1007/978-3-030-74886-9\\_7](https://doi.org/10.1007/978-3-030-74886-9_7)

7. Ávila-Gutiérrez, M.J., Martín-Gómez, A., Aguayo-González, F., Córdoba-Roldán, A.: Standardization framework for sustainability from circular economy 4.0. *Sustainability* **11**(22), 6490 (2019)
8. Amrina, E., Vilsì, A.L.: Key performance indicators for sustainable manufacturing evaluation in cement industry. *Procedia Cirp* **26**, 19–23 (2015)
9. Kanellou, E., Alexakis, K., Kapsalis, P., Kokkinakos, P., Askounis, D.: The DigiPrime KPIs' framework for a circular economy transition in the automotive industry. *Procedia Manuf.* **54**, 302–307 (2021)
10. Helleno, A.L., de Moraes, A.J.I., Simon, A.T.: Integrating sustainability indicators and Lean manufacturing to assess manufacturing processes: application case studies in Brazilian industry. *J Clean Prod.* **153**, 405–416 (2017)
11. Amrina, E., Ramadhani, C., Vilsì, A.L.: A fuzzy multi criteria approach for sustainable manufacturing evaluation in cement industry. *Procedia CIRP* **40**, 619–624 (2016)
12. Amrina, E., Yusof, S.M.: Key performance indicators for sustainable manufacturing evaluation in automotive companies. In: 2011 IEEE International Conference on Industrial Engineering and Engineering Management, pp. 1093–1097 (2011)
13. Steringer, R., Zörner, H., Zambal, S., Eitzinger, C.: Using discrete event simulation in multiple system life cycles to support zero-defect composite manufacturing in aerospace industry. *IFAC-PapersOnLine* **52**(13), 1467–1472 (2019)
14. Psarommatis, F., Kiritsis, D.: a hybrid decision support system for automating decision making in the event of defects in the era of zero defect manufacturing. *J. Ind. Inf. Integr.* **26**, 100263 (2022)
15. Psarommatis, F., May, G., Kiritsis, D.: Predictive maintenance key control parameters for achieving efficient zero defect manufacturing. *Procedia CIRP* **104**, 80–84 (2021)
16. Martinez, P., Al-Hussein, M., Ahmad, R.: A cyber-physical system approach to zero-defect manufacturing in light-gauge steel frame assemblies. *Procedia Comput. Sci.* **200**, 924–933 (2022)
17. Saxena, P., Stavropoulos, P., Kechagias, J., Salonitis, K.: Sustainability assessment for manufacturing operations. *Energies (Basel)* **13**(11), 2730 (2020)
18. Stavropoulos, P., Papacharalampopoulos, A., Michail, C., Vassilopoulos, V., Alexopoulos, K., Perlo, P.: A two-stage decision support system for manufacturing processes integration in microfactories for electric vehicles. *Procedia Manuf.* **54**, 106–111 (2021)


**Open Access** This chapter is licensed under the terms of the Creative Commons Attribution 4.0 International License (<http://creativecommons.org/licenses/by/4.0/>), which permits use, sharing, adaptation, distribution and reproduction in any medium or format, as long as you give appropriate credit to the original author(s) and the source, provide a link to the Creative Commons license and indicate if changes were made.

The images or other third party material in this chapter are included in the chapter's Creative Commons license, unless indicated otherwise in a credit line to the material. If material is not included in the chapter's Creative Commons license and your intended use is not permitted by statutory regulation or exceeds the permitted use, you will need to obtain permission directly from the copyright holder.





# Combining Research-, Project-, and Case-Based Learning in Higher Manufacturing Engineering Education

Tim van Erp<sup>(✉)</sup> 

Department of Technology and Innovation, University of Southern Denmark, Campusvej 55,  
5230 Odense, Denmark  
tve@iti.sdu.dk

**Abstract.** Research in higher manufacturing engineering education must continuously adapt to current and future challenges manufacturing companies are facing. Young engineering students must learn how to design, manage, and implement complex innovation projects. For this purpose, a teaching framework for combining research-, project-, and case-based learning is presented. A proof-of-concept discusses the design, implementation, and evaluation of a master's course at the University of Southern Denmark while following the teaching framework. The evaluation of the students' learning outcomes demonstrates the basic efficacy of the framework. A self-assessment by the students showed a sufficient increase in skills and competencies. The proposed teaching framework can contribute to realizing the Humboldtian idea of integrating research and teaching at universities.

**Keywords:** Higher engineering education · Research-based learning · Project-based learning · Case-based learning

## 1 Introduction and Rationale

A transition towards sustainable and digital value creation is at the core of Europe's new industrial policy [1]. This so-called Twin Transition is leading to new competitiveness challenges throughout Europe's manufacturing companies. They are required to adopt flexible, and circular value networks while also utilizing novel Industry 4.0 technologies. Consequently, curricula in higher engineering education must adapt to these new manufacturing trends. Manufacturing engineering students must learn how to design, manage, and implement complex innovation projects in manufacturing, cooperate in teams efficiently and effectively, communicate with different stakeholders, and apply methods and tools in the areas of sustainability and digitalization. Thus, new perspectives of teaching and learning in higher manufacturing engineering education are required that holistically combine teaching and research. This combination poses some complexity challenges to the planning and implementation of curricula: specific research objectives must be translated into specific learning activities which eventually comply with the intended learning objectives of the students. The paper aims at presenting a teaching framework for combining research- with project- and case-based learning in higher manufacturing engineering education.

© The Author(s) 2023

H. Kohl et al. (Eds.): GCSM 2022, LNME, pp. 1016–1024, 2023.

[https://doi.org/10.1007/978-3-031-28839-5\\_113](https://doi.org/10.1007/978-3-031-28839-5_113)

## 2 Theoretical Background

The proposed framework addresses three constructivist and inquiry-oriented approaches to education: research- (RBL), project- (PBL) and case-based learning (CBL).

RBL or the research-teaching nexus puts the focus on the research process. Students are participating in real-life research. RBL can be distinguished from research-led, research-tutored, and research-oriented teaching and learning [2–5]. Other authors mention self-regulatory and self-guided learning as relevant aspects of RBL [6]. RBL originates in Humboldt's vision for higher education by integrating research and learning [7]. RBL in higher engineering education often focuses on developing research skills such as analyzing data, interpreting, and reporting findings, or conducting experiments [3]. Hoskins and Mitchell introduce ingredients for creating a knowledge-together culture of students and researchers [8]. In manufacturing engineering, learning factories are proposed as a suitable didactical concept for realizing RBL [7].

PBL allows students to learn by doing and applying ideas through meaningful questions emulating what professionals in their field do and which are applied within real-world challenges [9, 10]. Thus, students work in groups to solve real and often interdisciplinary problems that culminate in a product and reflect on their learnings from the project experience [10–13]. The students decide how to tackle the problem [12]. PBL can cultivate innovative thinking [14], and there are indications that it facilitates students' motivation and cooperation [15]. For higher manufacturing engineering education, Stock and Kohl [16] discuss a transnational PBL approach utilizing Kolb's learning cycle [17]. Other approaches combine PBL with learning factories [18, 19] or with the design and operation of products and equipment or manufacturing processes and value networks [20–22].

CBL or case-based reasoning is a more guided inquiry approach compared to PBL [23]. In CBL, students create reasoning based on previous experience by typically using lessons learned from previous situations to understand and navigate new challenges [13, 24]. Kolodner et al. propose case-based learning aids to support the learning experience [25]. Research also indicates that discussion groups or group work can facilitate the learning experience in CBL [26]. In manufacturing engineering, CBL is a commonly used approach to convey relevant knowledge, skills, and competencies, e.g., through the co-creation of manufacturing artifacts [27].

The paper intends to contribute to knowledge gain in the research field of higher manufacturing engineering education by efficaciously combining RBL, PBL, and CBL within a teaching framework to prepare engineering students for a more and more complex working environment in the European Twin Transition.

## 3 Teaching Framework

This research in higher manufacturing engineering education follows a qualitative research approach. The teaching framework (Fig. 1) is conceptualized by utilizing state-of-the-art approaches in higher education. Primary building blocks are RBL, PBL, and CBL. It consists of three main teaching and learning artifacts that serve as key elements for curriculum development: 1. Research project, 2. Didactic concept, 3. Case(s). The

research project is determined by a scoped research task that the students should carry out following the idea of RBL and PBL. The didactic concept specifies relevant teaching and learning elements for executing the course while also incorporating the scoped research project. The case(s) address the structure of concrete case-based learning and teaching activities that reflect relevant learning goals for the research project while following the idea of CBL. Each of these main artifacts is in turn coined by specific sub-artifacts (1.1 to 3.3) described in Table 1.

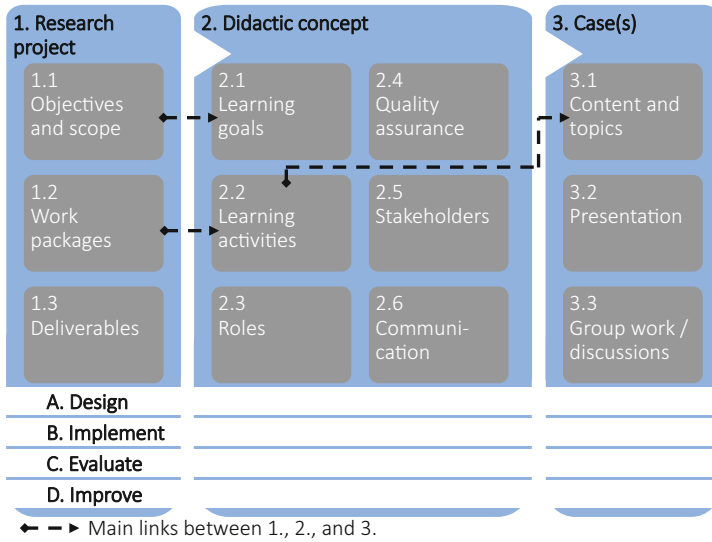


Fig. 1. Teaching framework for higher manufacturing engineering education.

Table 1. Description of sub-artifact of the teaching framework.

Nr	Description
1.1	The <b>objectives and scope</b> of the research project are specified. The objectives describe concrete research goals for the duration of the project. The scope concretizes the relevant systems which are to be investigated
1.2	<b>Work packages</b> with concrete tasks and time frames are formulated and specify the sequence of relevant activities for realizing the defined research objectives
1.3	The activities described throughout the work packages lead to intended research outcomes, which are determined by <b>deliverables</b> . Deliverables are digital or physical/tangible artifacts representing a relevant result for realizing the research objectives
2.1	<b>Learning goals</b> define relevant knowledge, skill, and competencies that the successful learner acquires by completing the course. The learning goals must be related to the context of the research project and its elements

(continued)

**Table 1.** (continued)

Nr	Description
2.2	For realizing the learning goals, concrete <b>learning activities</b> are formulated. They describe delimited and timed teaching units with defined learning tasks and teaching methods. A sub-set of learning activities is directly linked to executing the work packages of the research project
2.3	Depending on the learning activities, the teachers and learners might have to take on different <b>roles</b> . The expectations for these roles are clarified
2.4	<b>Quality assurance</b> specifies the procedure for realizing a high quality of teaching and learning throughout the course. It includes concrete measures for tracking the learning outcomes as well as the intended development of knowledge, skills, and competencies
2.5	The execution of the course might be depended on some internal and external key <b>stakeholders</b> . These stakeholders are determined. Required capacities from the stakeholder are considered for designing the learning activities
2.6	<b>Communication</b> sets out the communication channels between teachers, learners, and stakeholders. Suitable communication infrastructure and tools are selected
3.1	The development of the case <b>content and topics</b> is based on the defined learning activities. The case(s) supplement the research project by covering relevant learning goals, contents, and topics
3.2	From the developed case content and structure, the case <b>presentation</b> is derived. The presentation arranges the topics and contents of the case to create a holistic learning experience for the students
3.3	<b>Group work and group discussions</b> supplement the case presentation. This element can be used to foster the discussion and reflections of the students on how the case results can be transferred to the work packages of the research project

The development process of the teaching curriculum is divided into four phases (A-D): Design, Implement, Evaluate, and Improve. It follows the idea of a continuous improvement cycle [28]. The design is coined by creating all sub-artifacts 1.1 to 3.3. Usually, the design process can be structured into a fuzzier earlier phase where solutions for the sub-artifacts are conceptualized. This phase is followed by the detailed design of the conceptualized solutions. Implementation aims at executing the course with the research project, didactic concept, and the case(s). It covers the realization of the designed artifacts within a real learning environment. Evaluation aims at evaluating the quality of the designed artifacts based on empirical data from the implementation. It further allows deriving measures for the improvement of the framework for the next teaching and learning cycle. Improvement focuses on translating these measures into concrete re-design actions for the teaching framework's artifacts and sub-artifact.

## 4 Proof-of-Concept

The development of the teaching framework was carried out jointly with its ad-hoc implementation and evaluation within a master's course. The course is part of the master's

program in Engineering Operations Management at the University of Southern Denmark (SDU). Seven third-semester master's students participated in the 2022 cohort of the course. The three main artifacts of the framework, the research project (4.1), didactic concept (4.2), and the case(s) (4.3), were designed and implemented.

#### 4.1 Research Project

The research project aims at developing an automated and digitalized additive manufacturing (AM) system embedded in an Industry 4.0 environment. This includes the automation of the value creation in the context of an AM system from setting up and equipping the 3D printer with materials, to quality control, and all material handling steps. Seven work packages based on a DEV-OPS project management approach [29] are created with related deliverables. Table 2 exemplarily shows the description of work package 3. A Gantt-Chart for executing the work packages within 24 months as well as the expected time frames for realizing three intended project milestones are defined. Since the duration of the master's course is only five months, the course allows an effective coverage of the first three work packages.

**Table 2.** An exemplary description of work package 3 (WP3).

Task:	WP3 is oriented toward developing the different domains of the AM system, namely the mechanical, electrical/electronic, and software domains for the physical and virtual systems. These domains can be interpreted as sub-systems of the AM system which are fulfilling distinct functions
Deliverable:	Solutions for the relevant domains of the digital and automated AM system

#### 4.2 Didactic Concept

The learning goals of the course address relevant knowledge, skills, and competencies required for successfully designing, managing, and implementing complex technology projects. The learning activities are divided into two categories. Firstly, 12 individual teaching sessions à three hours are defined related to the following topics: (1) Technology trends; (2) management of technology projects; (3) technology assessment. Each of these topics includes a sequence of individual teaching sessions. Secondly, a project assignment is created for the students. The project assignment covers the first three work packages of the research project and is to be carried out as group work. The students must hand in a group report about the results of the project including a reflection on their contributions to the project. The teacher needs to fulfill different roles, such as a presenter of knowledge or a moderator of exercises. Another relevant role is the project sponsor role for the project assignment to facilitate the project's progress. The quality assurance of the course is conducted in two ways. The learning outcomes of the students are evaluated based on a final oral exam. Additionally, the students can give feedback within an anonymous mid-term and final evaluation of the course. Relevant stakeholders



for the course are the head of SDU's Industry 4.0 lab, who needs to support the practical implementation of hardware and software solutions as well as guest lecturers who can deliver specific knowledge or practical experiences supplementing the learning goals. Besides, the vendors of the equipment, e.g., the 3D printers, must be considered. For communicating with the students, SDU's eLearning platform is used in which all learning materials as well as the description of the research project are made available. Most of the course-related discussions are taken during the 12 teaching sessions.

### 4.3 Case(s)

For transferring the planned teaching activities, i.e., the 12 teaching sessions into concrete learning experiences, two cases are designed: one case addressing the development process of a tower system for wind turbines, the "SmarTower" case, while the second case is based on a sharing platform for consumer tools, the "Toolbot" case. Both cases intend to deliver the necessary knowledge, skills, and competencies which are required for the research project. Throughout the case-based teaching sessions, the students need to interpret, reflect, and transfer the results from the cases to their project assignments. Especially, the transfer of knowledge from the case to the research project seems to substantially support the learning outcomes. Table 3 provides an overview of the agenda for an individual case-based teaching session.

**Table 3.** Agenda of a case-based teaching session as part of the technology assessment topic.

---

a) Introduction to the "Toolbot" case, 8.30–8.45 am
b) Project Costs, with group work/ discussion, 8.45–9.30 am
c): Customer Lifetime Value, with group work/ discussion, 9.45–10.15 am
d): Customer Acquisition Costs, with group work/ discussion, 10.25–11.10 am

---

### 4.4 Evaluation of Learning Outcomes

For measuring the efficacy of the proposed teaching framework, different qualitative and quantitative empirical data were collected and evaluated. Firstly, the students of the course participated in an anonymous midterm and final course evaluation survey. Selected results from the final course evaluation are presented in Table 4. Secondly, for the "Toolbot" case, a separate case evaluation was conducted. This evaluation was twofold. It was based on an anonymous student survey as well as on observations from two external consultants in the field of higher education and case-based teaching.

### 4.5 Discussion of Results and Limitations

The proof-of-concept verifies that the conceptualized teaching framework can be applied for designing, implementing, and evaluating a course in higher manufacturing engineering education. The evaluation of the learning outcomes demonstrates a solid efficacy of

**Table 4.** Selected results from the final course evaluation (number of participants, n = 5).

<b>Question (Q):</b> How would you self-assess your increase in skills and competencies for managing complex technology projects by the end of the course – on a scale from 1 (no increase) to 10 (very high increase)?
<b>Result (R):</b> 40% (8); 20% (7); 20% (5); 0% (1, 2, 3, 4, 6, 9, 10); Average: 7
<b>Q:</b> The group work on the Mads Clausen research project supported my learning outcomes on how to manage complex technology projects
<b>R:</b> 60% (I partly agree); 20% (I agree); 20% (I partly disagree); 0% (I disagree)

the framework. The self-assessment of the students' increase in skills and competencies shows satisfactory improvements. The students partially agreed that the research project supported their learning outcomes. Thus, improvements to the course design might focus on scoping the research project with its work packages. Limitations are linked to comparing the efficacy of the framework to other teaching and learning approaches and frameworks. For example, it remains unclear if a mere research-, project-, or case-based learning approach would have led to similar learning outcomes.

## 5 Summary and Outlook

A teaching framework for combining research-, project-, and case-based learning with three main teaching and learning artifacts and four development phases was presented. A proof-of-concept discussed the design, implementation, and evaluation of a concrete course of a master's program at SDU while following the proposed teaching framework. The evaluation of the students' learning outcomes demonstrated the basic efficacy of the teaching framework. A self-assessment by the students showed a sufficient increase in skills and competencies for managing complex technology projects by the end of the course. The author believes that the proposed teaching framework can contribute to realizing the Humboldtian idea of integrating research and teaching at universities by providing a detailed guideline for developing curricula in higher manufacturing engineering education. Future research will investigate the beneficial design of the research project for providing a high-quality learning experience to the students.

## References

1. European Commission. Making Europe's businesses future-ready: a new industrial Strategy for a globally competitive, green and digital Europe (2020)
2. Dekker, H., Wolff, S.W.: Re-inventing research-based teaching and learning. In: European Forum for Enhanced Collaboration in Teaching of the European University Association in Brussels (2016)
3. Camacho, M.H., Valcke, M., Chiluiza, K.: Research based learning in higher education: a review of literature. In: 11th International Technology, Education and Development Conference, INTED2017 (2017)

4. Griffiths, R.: Knowledge production and the research–teaching nexus: the case of the built environment disciplines. *Stud. High. Educ.* **29**(6), 709–726 (2004)
5. Healey, M., Jenkins, A.: *Developing undergraduate research and inquiry: higher education academy* York (2009)
6. Huber, L.: Forschungsbasiertes, Forschungsorientiertes, Forschendes Lernen: Alles das-selbe? Ein Plädoyer für eine Verständigung über Begriffe und Unterscheidungen im Feld forschungsnahen Lehrens und Lernens. *Das Hochschulwesen.* **62**(1), 2 (2014)
7. Blume, S., Madanchi, N., Böhme, S., Posselt, G., Thiede, S., Herrmann, C.: Die Lernfabrik – research-based learning for sustainable production engineering. *Procedia CIRP.* **32**, 126–131 (2015)
8. Hoskins, S.L., Mitchell, J.: Innovative pedagogies: research based learning, taking it a step further. *Higher Education Academy.* 2015. <https://www.heacademy.ac.uk/research-based-learning-taking-it-step-further>
9. Krajcik, J.S., Blumenfeld, P.C.: Project-based learning. *The Cambridge Handbook of the Learning Science.* pp. 317–334 (2006)
10. Kokotsaki, D., Menzies, V., Wiggins, A.: Project-based learning: a review of the literature. *Improv. Sch.* **19**(3), 267–277 (2016)
11. Blumenfeld, P., Fishman, B.J., Krajcik, J., Marx, R.W., Soloway, E.: Creating usable innovations in systemic reform: Scaling up technology-embedded project-based science in urban schools. *Educ. Psychol.* **35**(3), 149–164 (2000)
12. Solomon, G.: Project-based learning: a primer. *Technol. Learn.* **23**(6), 20 (2003)
13. Kolodner, J.L., Hmelo, C.E., Narayanan, N.H.: Problem-based learning meets case-based reasoning. In: *Association for the Advancement of Computing in Education (AACE)*, (1996)
14. Barak, M., Yuan, S.: A cultural perspective to project-based learning and the cultivation of innovative thinking. *Thinking Skills Creativity.* **39**, 100766 (2021)
15. Shin, M.-H.: Effects of project-based learning on students’ motivation and self-efficacy. *English Teach.* **73**(1), 95–114 (2018)
16. Stock, T., Kohl, H.: Perspectives for international engineering education: sustainable-oriented and transnational teaching and learning. *Procedia Manuf.* **21**, 10–17 (2018)
17. Kolb, A.Y., Kolb, D.A.: Learning styles and learning spaces: enhancing experiential learning in higher education. *Acad. Manag. Learn. Educ.* **4**(2), 193–212 (2005)
18. Lawrence, J., Dimashkie, B., Centea, D., Singh, I.: The learning factory: self-directed project-based education. In: Auer, M.E., Centea, D. (eds.) *ICBL 2020. AISC*, vol. 1314, pp. 114–122. Springer, Cham (2021). [https://doi.org/10.1007/978-3-030-67209-6\\_13](https://doi.org/10.1007/978-3-030-67209-6_13)
19. Zarte, M., Pechmann, A.: Implementing an energy management system in a learning factory—a project-based learning approach. *Procedia Manuf.* **45**, 72–77 (2020)
20. Abellán-Nebot, J.V.: Project-based experience through real manufacturing activities in mechanical engineering. *Int. J. Mech. Eng. Educ.* **48**(1), 55–78 (2020)
21. Aqlan, F., Nwokeji, J.C., (eds.) Applying product manufacturing techniques to teach data analytics in industrial engineering: a project based learning experience. In: *2018 IEEE Frontiers in Education Conference (FIE)*, pp. 1–7 (2018)
22. Alptekin, S.E., DeTurris, D., Macy, D.J., Ervin, J.E.: Development of a flying eye: a project-based learning experience. *J. Manuf. Syst.* **24**(3), 226–236 (2005)
23. Srinivasan, M., Wilkes, M., Stevenson, F., Nguyen, T., Slavin, S.: Comparing problem-based learning with case-based learning: effects of a major curricular shift at two institutions. *Acad. Med.* **82**(1), 74–82 (2007)
24. Kolodner, J.L., Dorn, B., Thomas, J.O., Guzdial, M.: Theory and practice of case-based learning aids. *Theor. Found. Learn. Environ.* 142–170 (2012)
25. Kolodner, J.L., Owensby, J.N., Guzdial, M.: Case-based learning aids. In: *Handbook of Research on Educational Communications and Technology.* Routledge, Milton Park, pp. 820–852 (2013)

26. Flynn, A.E., Klein, J.D.: The influence of discussion groups in a case-based learning environment. *Educ. Tech. Res. Dev.* **49**(3), 71–86 (2001)
27. Albers, A., Bursac, N., Heimicke, J., Walter, B., Reiß, N.: 20 years of co-creation using case based learning. In: Auer, M.E., Guralnick, D., Simonics, I. (eds.) *ICL 2017. AISC*, vol. 716, pp. 636–647. Springer, Cham (2018). [https://doi.org/10.1007/978-3-319-73204-6\\_69](https://doi.org/10.1007/978-3-319-73204-6_69)
28. Ries, E.: *The lean startup: How today's entrepreneurs use continuous innovation to create radically successful businesses*. Currency (2011)
29. van Erp T., Rytter, N.G.M., Sieckmann, F., Larsen, M.B., Blichfeldt, H., Kohl, H.: Management, design, and implementation of innovation projects: towards a framework for improving the level of automation and digitalization in manufacturing systems. In: *2021 9th International Conference on Control, Mechatronics and Automation (ICCMA)*, pp. 211–217 (2021)

**Open Access** This chapter is licensed under the terms of the Creative Commons Attribution 4.0 International License (<http://creativecommons.org/licenses/by/4.0/>), which permits use, sharing, adaptation, distribution and reproduction in any medium or format, as long as you give appropriate credit to the original author(s) and the source, provide a link to the Creative Commons license and indicate if changes were made.

The images or other third party material in this chapter are included in the chapter's Creative Commons license, unless indicated otherwise in a credit line to the material. If material is not included in the chapter's Creative Commons license and your intended use is not permitted by statutory regulation or exceeds the permitted use, you will need to obtain permission directly from the copyright holder.



# **Sustainability at Regional Level**



# Converted and Shared Light Electric Vehicles in Ghana: A Technical and Economic Analysis Based on Converted ICE Motorbikes and e-mopeds

Frederick Adjei<sup>1</sup> (✉), Denise Sperling<sup>1</sup>, Isaac Atia-Abugbilla<sup>2</sup>, Arnold Anokye<sup>2</sup>,  
George Appiah<sup>2</sup>, Godwin Ayetor<sup>3</sup>, and Semih Severengiz<sup>1</sup>

<sup>1</sup> Bochum University of Applied Sciences, Sustainable Technologies Laboratory, Am  
Hochschulcampus 1, 44801 Bochum, Germany  
Frederick.adjei@hs-bochum.de

<sup>2</sup> Solar Taxi Ghana, 6 Naa Asia Rd, Laterbiokoshie, Accra, Ghana

<sup>3</sup> Kwame Nkrumah University of Science and Technology, Private Mail Bag, University Post  
Office, Kumasi, Ghana

**Abstract.** This paper sets out to examine the economic and technical viability of LEVs in Ghana as a business model. It further examines the profitability of converted motorbikes which are adapted from ICE motorbikes. The business model is built on technical requirements of the ICE conversion in Ghana. The authors used a case study approach to analyze an exemplary business model based on 40 e-mopeds and 20 stand-alone solar charging stations deployed on the campus of KNUST until December 2021. A further analysis was also done on the process of converting an ICE motorbike to create a minimum viable product which runs on electricity. The business model examines the profitability of such converted motorbikes taking into account production and assembly costs while also considering fixed costs. The results of the analysis prove that a single e-moped deployed in the model was profitable after 6.3 years and a converted motorbike was profitable compared to a conventional motorbike between 22500 km to 32500 km of use depending on the purchase scenario. The discussion and results provide a good basis for further research and give support to sustainable business models and manufacturing of LEVs.

**Keywords:** Electromobility · Sharing Systems · Sustainable Business Models

## 1 Introduction

Ghana has posted robust pre-pandemic economic growth over the past two decades. GDP per capita grew by an average of 3% over the period. With poverty alleviation programs initiated and continued by successive governments, poverty rates have halved between 1998 and 2016 [1]. The economic performance is further supported by the discovery of oil in the Ghanaian sector of the gulf of Guinea which elevated the country to middle income status [2]. Figures from the Ghana Statistical Service indicate

a post-independence population growth of 6.7million in 1960 to 30.8 million in 2022 [3]. However increasing population and economic growth have a direct correlation to increased mobility needs as noted by Ayetor et al. [4]. Out of the 72 million vehicles in use in Africa, Ghana accounts for 2.5 million [4]. Mobility needs in Ghana until now has been fossil-fuel based with limited research and implementation of sustainable mobility options. This paper seeks to assess the profitability of a business model based on Light Electric Vehicles (LEVs) in a shared environment based on the campus of the Kwame Nkrumah University of Science and Technology (KNUST). It also assesses a business model based on a converted Internal Combustion Engine (ICE) motorbike for the city of Sunyani where a minimum viable product was developed with the University of Energy and Natural Resources and the local startup Solar Taxi. A cursory analysis of the technical requirements for the conversion of a converted ICE motorbike is also provided while respecting the proprietary information of Solar Taxi, the private partner involved in the research. The objective of such a sustainable mobility solution would be to provide transportation access whilst minimizing resource consumption and traffic congestion utilizing a sharing system for LEVs. Questions to be answered by this paper are elaborated as follows:

- I. Can business models on a university campus based on shared light electric vehicles be operated economically?
- II. What are the technical requirements for the conversion of an ICE motorbike to an electrically powered model?
- III. Can a business model based on converted ICE motorbike be operated economically?

## **2 An Overview of Sustainable Business Models, LEV Sharing Systems and the Conversion of ICE Motorbikes to e-motorbikes**

The sustainable business model draws on the tenets of the traditional business model. The business model concept gained prominence in the early days of the internet, the so-called dot.com era [5]. On a general level it is a statement [5], a description [6], a representation [7], a conceptual tool or model [8], a structural template [5, 9], and a framework [9], to name a few. It is assumed that innovations on a business model level tend to yield higher returns when compared to product or process innovations [9]. The Business Model Canvas presents a framework for visualizing and structuring business models on an organizational level or on a unit basis [9]. For organizational decision-making and academic research in the context of emerging industrial phenomena, like Industry 4.0 or Re-Distributed Manufacturing [9, 10], the business model concept allows firms to elaborate the potential customer and value chain benefits and compare or generate the required configuration and implementation of the other business model elements or units [9, 11].

The canvas is geared toward economic benefit only, hence to transition to a sustainable model, amendments would be required. The definitions in various literature see sustainable business models as a modification of the conventional business model concept, with certain characteristics and goals added to it; and, they either 1) incorporate concepts, principles, or goals that aim at sustainability; or 2) integrate sustainability into their value proposition, value creation and delivery activities [9]. Geissdoefer et al. concretely define the sustainable business model as a business model that incorporates pro-active multi-stakeholder management, the creation of monetary and non-monetary value for a broad range of stakeholders and hold a long-term perspective [9, 11].

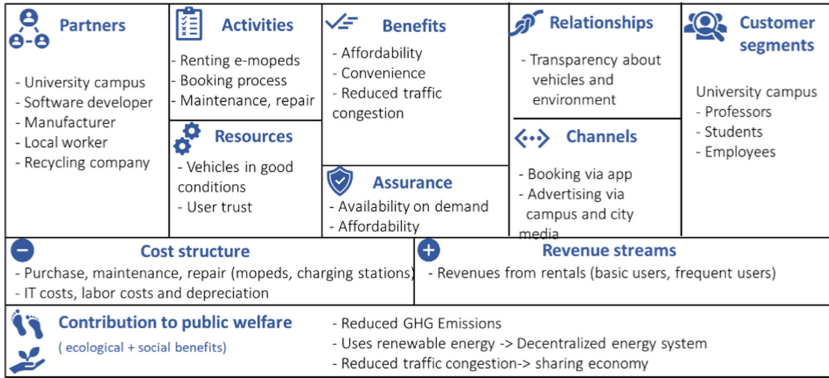
The use of light electric vehicles (LEVs) is slowly gaining prominence with efforts made to introduce such devices in Ghana in various international development programs [12]. In general terms, between 17% and 49% of trips made and 6% to 30% of the distance covered by private trips can be substituted by LEVs [13]. A study by Schelte et al. found that e-moped sharing resulted emissions of 20–58 g CO<sub>2</sub>-eq./pkm which is comparable to emissions from electric buses (27–52 g CO<sub>2</sub>-eq./pkm) [14]. As 81% of trips can be substituted by the use of e-mopeds, this statistic is significant [14] in reducing Ghana's GHG emissions. Sustainable mobility is aided by the sharing of LEVs in a closed system [15]. About 8% of households reported surveys by the Ghana ministry of roads and transport that owning between one and four motorbikes which were in good condition for private use [16]. In total there was a stock of approximately 2.4 million conventional motor bikes in year 2012 [16]. With a current estimated population of 30.8 million people [3] and an assumption of a constant share of conventional motorbikes per person there could be a stock of 2.86 million conventional motorbikes in 2022. With such an estimation, current potential demand for e-motor bikes is 2.8 million e-motor bikes, as this is the calculated and estimated current number of conventional motor bikes in Ghana. A research gap exists on the viability of a sustainable business model based on e-mopeds, the business potential for converted ICE motorbikes and the environmental impact of such a substitution of conventional ICE motorbikes.

## 3 Methodology

### 3.1 Profitability of a Shared LEVs on a Campus

The possibility of an e-moped sharing system at the KNUST University in Kumasi is imagined as an example that can be scaled up to similar institutions in Ghana. Assumptions have been estimated based on one-on-one interviews and email correspondence with experts in the field of EV sharing systems (Russ P., Tier Mobility GmbH, 2021), findings after reviews of the Ghanaian tax and business registration systems (Aryee M.A., MEK Consult and HR Essentials LLC, 2021), and the business model of the private e-mobility service provider, Solar Taxi Ghana. Details of correspondence is included in the appendix. Detailed cost considerations can be found in the appendix giving greater context to the profitability analysis. An average drive on campus from takes eight minutes based on existing campus shuttle service, speed limits and a survey of students and staff on the KNUST campus to understand transport needs and dynamics [17]. 10 cents per minute was set as the fee per ride based on current costs on the campus. A business model canvas for the operation is provided below (Table 1):





**Fig. 1.** Business Model Canvas for campus sharing system based on the work of Osterwalder & Pigneur [11, 18]

**Table 1.** Assumptions for shared LEV business model on a university campus.

Description	Assumption
Number of e-mopeds	40 e-mopeds with an LEV available every 500 m
Number of rides	10 rides per LEV a day
Replacement of e-mopeds	1,5 new e-mopeds per year needed compensate for the loss caused by theft, vandalism, and total damage

### 3.2 Conversion and Profitability Analysis of an ICE Motorbike

Technical feasibility of conversion of an ICE motorbike is proven by the creation of a minimum viable product (MVP) of a converted motorbike. Due to protection of proprietary information and protection of trade secrets of the private firm Solar Taxi, a basic overview of the conversion process and its key components are provided. The components of electric motorbike that require modifications include the original frame, swingarm, brushless DC motor, electronic speed controller (ESC), lithium-ion battery pack, power transmission, DC-DC converter. Parts that were replaced are; the engine, starter battery, throttle, clutch lever and dashboard. These parts were replaced with: 5kW chain driven motor, 50Ah Li-ion battery pack, motor controller, hall sensor throttle, and an electronic dashboard. Mechanical fabrication involved creating a platform to seat the electric motor, creating a housing for the battery pack a platform to mount the motor controller. The former location for the engine now contains the electric motor and the battery pack. The former location for the battery that powers the starter now houses the motor controller which translates actions such as turning the throttle into forward or backward movement. The battery used in the conversion is the HYSJ 21700E. This cell has a 3.7V nominal voltage and capacity of 17.76 Wh. It has a nominal capacity of 4800 mAh, has a maximum charge current of 3A and a maximum discharge current of 15A continuous and 25A short term. Determination of the potential pricing model for the converted motorbike was done by analyzing the cost implications of commercial

production and market entry scenarios. Both analysis is based on information and interviews with the private sector firm Solar Taxi. There are two different business models when it comes to conventional motorcycle conversion. In the first scenario, the company buys conventional used motorcycles, converts them into e-motorcycles and sells them to customers who do not yet own a motorbike. In second scenario, the customer brings his own conventional motorbike to the company and the company converts it into an e-motorbike. Costs are presented in the excel appendix and used for the profitability analysis (Fig. 1, 2 and 3).



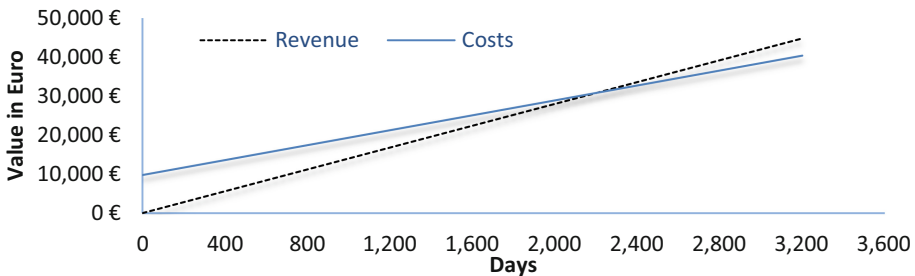
**Fig. 2.** a. Conventional motorbike stripped internal combustion engine (top right, Model: Haojin 125–32, 150cc). b. Rewired conventional motorbike linked to a battery pack (top left). c. Fully converted ICE motorbike at the campus of UENR (Left)(original model was Haojin 125–32, 150cc). d. E-mopeds and stand-alone solar charging stations on the campus of KNUST (Right).

### 4 Results and Discussions

Figure 4 shows the plotting of revenue vs known costs and shows an approximate break-even point after 2.300 days and thus 6.3 years. Since the exact costs for the software development are currently unknown, it can be assumed that the calculation will shift, and that profitability will occur sooner. An overview of costs and assumptions used in the analysis is elaborated below (Table 1 and 2).

**Table 2.** Costs and revenue overview per e-moped.

Cost type	Description	Cost	Cost/e-moped
Onetime costs	e-mopeds, solar charging stations, equipment	387.760€	9.694,€
Fixed monthly costs	Wages, rental and operational costs	2.968€	2,44€
Variable monthly costs	Replace, theft, software use, update	313,38€	1,83€
Cost per ride	Credit card, insurance fees, repair, city permits	6.393,23€	0,53€
Revenue per ride	Fixed fee and minimum 8minute ride		1,40€



**Fig. 3.** Days until one e-moped is economical.

The cost of a converted motorbike in scenario 2 is less than a brand-new converted electric motorbike as defined in scenario 1 and the product might be more suitable for the local environment. In addition, the converted motorbike also has ecological advantage in that it is in fact a reuse case. An assessment of the price of the converted motorcycle from scenario one, the sales price is even higher and exceeds the price of a new electrically powered-motorbike. Graphs of operating costs of converted bikes vs ICE motorbikes for both scenarios 1 and 2 are generated to demonstrate the profitability of the converted motorbike as there is insufficient data for a full business case analysis. It can be observed the rising costs of ICE motorbikes in both instances compared to a steady slow rise in cost for the converted motorbike with break-even achieved after about 32.500 km of operation in scenario 1 and 22.500 km in scenario 2. It is assumed that the converted

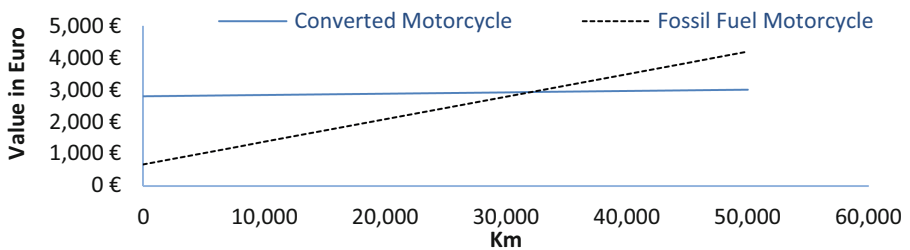
motorbikes will be powered by solar charging stations whose cost is counted once as part of equipment costs hence no further costs are incurred for electricity supply. Solar charging stations used in the analysis are designed to power two e-mopeds at a time (Table 3, 4 and Fig. 5).

**Table 3.** Costs and sales overview of converted motorbike vs ICE motorbike.

Cost type	Description	Cost
Onetime equipment costs	Cost of fabrication equipment, specialized tools, etc	4.305€
Cost of ICE motorbike	Cost of traditional motorcycle purchase	672€
Sales cost for converted motorbike (Scenario 1)	Sales cost based on imagined business model scenario 1 as elaborated above	2.856,43€
Sales cost for converted motorbike (Scenario 2)	Sales cost based on imagined business model scenario 2 as elaborated above	2.148,32€

**Table 4.** Costs considered for operational costs of converted motorbike vs ICE motorbike.

Cost type	Description
Purchase	converted motorbike is dependent on the scenario whiles ICE motorbike is purchased once
Engine oil	Cost for engine oil change considered as 2,80€ per month
Fuel	Costs for ICE motorbike fuel considered as 2,80€ per 100 km
Maintenance	Costs for ICE motorbike assumed to be 14,00€; costs for converted motorbike assumed at 2,80€



**Fig. 4.** Kilometers until the converted motorcycle is economical (scenario 1)

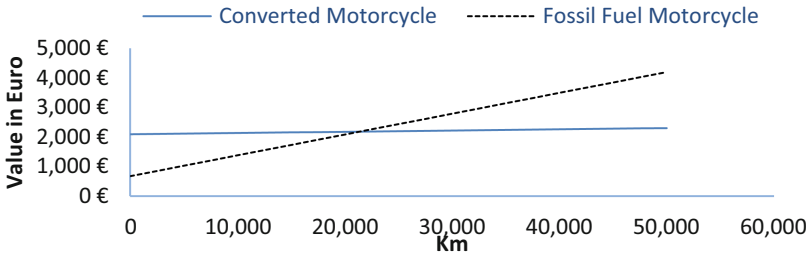


Fig. 5. Kilometers until which the converted motorcycle is economical (scenario 2)

## 5 Conclusions

Comparing the elaborated business models of LEVs on KNUST campus and the models for converted motorbikes with literature shows that these models do fall under the structures defined by Zott et al. [5] in that they are sustainable in terms of emissions reduction and innovative being adapted to the local environment and pricing constraints. They are also well within the definitions of Geissdöfer et al. [9], sitting between sustainable business models and circular business models due to the replacement of used ICE motorbikes with converted e-mopeds. The results elaborated proves from the pilot of shared devices on campus of the Kwame Nkrumah University of Science and Technology and as well the development of the prototype converted motorbike that these business models are indeed feasible despite long periods to profitability. Consumers in Ghana usually use mobility devices for a long period of time opting for repair and maintenance as opposed to newer models. Proving the economic viability of one e-moped is necessary to extrapolate that the business model as a whole would be profitable. In both scenarios of a business model based on a converted motorbike, it was observed that lower operating costs made these models cheaper over the lifetime compared to ICE motorbikes and present a valid business case. The sales prices indicated are based on pilot projects and prototypes and hence are on the higher-end of cost pricing. These costs should reduce further with higher production rates due to the principles of economies of scale. This represents a limitation of the paper as well as these benefits are not explored to reduce sales costs. Further analysis in operating costs are needed to provide a deeper insight into lifetime costs and end-of-life costs for the converted motorbike. Finally, while this paper lays out the technical feasibility of conversion, a performance review of the minimum viable product is needed to compare with e-mopeds and ICE motorbikes. Emissions reduction potential are well documented in literature internationally, however further research on the specific emissions reduction for these business models need to be investigated by means of a life-cycle assessment taking into account the local Ghanaian environment.

**Acknowledgements.** Funding for this research is from by German Federal Ministry for the Environment, Nature Conservation, Nuclear Safety and Consumer Protection under the project [MoNaL](#) which is part of the funding program "Promotion of projects in the field of the export initiative environmental technologies". Project Number: 16EXI4011A. Project Executing Agency: ZUG gGmbH.

## Appendix

The authors provide a [cloud](#) folder with raw data from profitability analysis to provide further context for graphs and figures.

## References

1. World Bank, Ghana rising. Accelerating Economic Transformation and Creating Jobs, GHANA Ctry. Econ. MOMORANDUM Rep. No AUS0002590, 2021, [www.creativecommons.org/licenses/by/3.0/igo](http://www.creativecommons.org/licenses/by/3.0/igo)
2. Moss, T.J., Majerowicz, S.: No longer poor: ghana's new income status and implications of graduation from IDA. SSRN Electron. J. (2012). <https://doi.org/10.2139/ssrn.2102796>
3. G. S. Service, Ghana 2021 Population and Housing Census: General Report Volume 3A, 2021, <https://statsghana.gov.gh/gssmain/fileUpload/pressrelease/2021>. PHC General Report Vol 3A\_Population of Regions and Districts\_181121.pdf
4. Ayetor, G.K., Opoku, R., Sekyere, C.K.K., Agyei-Agyeman, A., Deyegbe, G.R.: The cost of a transition to electric vehicles in Africa: a case study of Ghana. Case Stud. Transp. Policy **10**(1), 388–395 (2022). <https://doi.org/10.1016/j.cstp.2021.12.018>
5. Zott, C., Amit, R., Massa, L.: The business model: recent developments and future research. J. Manage. **37**(4), 1019–1042 (2011). <https://doi.org/10.1177/0149206311406265>
6. Foss, N.J., Saebi, T.: Business models and business model innovation: between wicked and paradigmatic problems. Long Range Plann. **51**(1), 9–21 (2018). <https://doi.org/10.1016/j.lrp.2017.07.006>
7. Morris, M., Schindehutte, M., Allen, J.: The entrepreneur's business model: toward a unified perspective. J. Bus. Res. **58**(6), 726–735 (2005). <https://doi.org/10.1016/j.jbusres.2003.11.001>
8. George, G., Bock, A.J.J.: The business model in practice and its implications for entrepreneurship research. SSRN Electron. J. (2011). <https://doi.org/10.2139/ssrn.1490251>
9. Geissdoerfer, M., Vladimirova, D., Evans, S.: Sustainable business model innovation: a review. J. Clean. Prod. **198**, 401–416 (2018). <https://doi.org/10.1016/j.jclepro.2018.06.240>
10. Fathi, P.M.P.: Mahdi, M.K.: Optimization in large scale problems (2019)
11. Joyce, A., Paquin, R.L.: The triple layered business model canvas: a tool to design more sustainable business models. J. Clean. Prod. **135**(May), 1474–1486 (2016). <https://doi.org/10.1016/j.jclepro.2016.06.067>
12. Adjei, F., Cimdador, T., Severengiz, S.: Electrically powered micro mobility vehicles in Ghana: transition process with a focus on social acceptance. In: 29th CIRP Life Cycle Engineering Conference, vol. 105, pp. 764–769 (2022). <https://doi.org/10.1016/j.procir.2022.02.127>
13. Ewert, A., Brost, M., Eisenmann, C., Stieler, S.: Small and light electric vehicles: an analysis of feasible transport impacts and opportunities for improved urban land use. Sustainability **12**(19) (2020). <https://doi.org/10.3390/su12198098>
14. Schelte, N., Severengiz, S., Schünemann, J., Finke, S., Bauer, O., Metzgen, M.: Life cycle assessment on electric moped scooter sharing. Sustainability **13**(15) (2021). <https://doi.org/10.3390/su13158297>
15. Kumar, V., Lahiri, A., Bahadir, O.: A strategic framework for a profit table business model in the sharing economy. Ind. Mark. Manag. no. April 2019, p. 1 (2017). <https://doi.org/10.1016/j.indmarman.2017.08.021>

16. M. of R. and H. G. S. Service, Second National Household Transport Survey; support for the transport sector development programme (2012)
17. Mensah, E.: Research report: user experience with electric motorbikes and a sharing system on Kwame Nkrumah University of Science and Technology campus Ghana, Kumasi (2021)
18. Parry, Z.: Book review: business model generation: a handbook for visionaries, game changers, and challengers. *Int. J. Entrep. Innov.* **15**(2), 137–138 (2014). <https://doi.org/10.5367/ijei.2014.0149>

**Open Access** This chapter is licensed under the terms of the Creative Commons Attribution 4.0 International License (<http://creativecommons.org/licenses/by/4.0/>), which permits use, sharing, adaptation, distribution and reproduction in any medium or format, as long as you give appropriate credit to the original author(s) and the source, provide a link to the Creative Commons license and indicate if changes were made.

The images or other third party material in this chapter are included in the chapter's Creative Commons license, unless indicated otherwise in a credit line to the material. If material is not included in the chapter's Creative Commons license and your intended use is not permitted by statutory regulation or exceeds the permitted use, you will need to obtain permission directly from the copyright holder.





# New Insights into the Polymer Coating of Mild Steel Using Activated Orange Juice Functionalized Rice Husk Nanoparticles

V. S. Aigbodion<sup>1,2,3(✉)</sup> and P. A. Ozor<sup>1,4</sup>

<sup>1</sup> Faculty of Engineering and Built Environment, University of Johannesburg, P. O. Box 534, Auckland Park, South Africa

<sup>2</sup> Department of Metallurgical and Materials Engineering, University of Nigeria, Nsukka, Nigeria

victor.aigbodion@unn.edu.ng

<sup>3</sup> Africa Centre of Excellence, ACESPED University of Nigeria, Nsukka 410001, Nigeria

<sup>4</sup> Department of Mechanical Engineering, University of Nigeria, Nsukka, Nigeria

**Abstract.** Novel insights in the development of polymer coating of mild steel using functionalization of rice husk ash nanoparticles by activated orange juice were investigated. For the potentiostat/galvanostat corrosion performance of the coated materials, 5 wt% potassium sulfate ( $K_2SO_4(aq)$ ), 5 wt% sodium chloride ( $NaCl(aq)$ ), and 1 M sulfuric acid ( $H_2SO_4(aq)$ ) were used. 78.81, 71.86, and 55.11% corrosion resistance of the samples of  $K_2SO_4$ ,  $H_2SO_4$ , and  $NaCl$ . It was concluded that orange juice was able to enhance the dispersion of RHnp in the epoxy coating. The presence of citrate ions in the orange juice acts as a stabilizer and reducing agent, which was attributed to the fine grain size and good corrosion resistance of the composite coating. The work has established that rice husk ash nanoparticles by activated orange juice can be used in the development of composites coating mild steel.

**Keywords:** Rice husk · Orange juice · microstructure · Corrosion · Nanoparticle

## 1 Introduction

The epoxy coating of mild steel has been used in recent times to combat the high steel in concrete [1]. The good corrosion resistance, poor electrical conductivity, and ease of application are the reasons behind the usage of epoxy coating in concrete [2]. However, the properties of the coating may not withstand service conditions such as wear, marine, or seawater corrosion, as a result of the hydrophilic feature of epoxy, which weakens the coating [3, 4]. Hence, an effort has been made by the researcher to add second phase nanoparticles to overcome this great problem. Tianhao Ge et al. [5] reported on the microstructural and electrochemical behavior of an epoxy-grapheme-zinc multilayer coating. Xianming et al. [6] reported on the corrosion resistance and mechanical properties of an epoxy coating of mild steel with  $Fe_2O_3$ ,  $SiO_2$ , Zn, and clay nanoparticles. They all concluded that incorporation of nanoparticles into epoxy results in clustering



and agglomeration of particles [7] and that functionalization and blending treatment of the nanoparticles can reduce the limitations [8]. For example, organic and inorganic compounds such as polyaniline emeraldine salt and aminopropyltriethoxysilane have been used to functionalize nanowhiskers/epoxy coating of mild steel by Cleide Borsoia et al. [9].

The researcher has shown that the inorganic and organic compounds are not eco-friendly and costly, which hindered the wide usage of these compounds in the functionalization of nanoparticles for mild steel. Effort was made in this work to develop a reducing agent using plant extract (orange juice) [10] because it has been reported by Aigbodion et al. [11] that orange juice contains phenolic compounds (ferulic, hydroxybenzoic, hesperidin, hydroxycinnamic, ascorbic, and citric) that can be used as functionalization of nanoparticles for epoxy coating of mild steel [12]. This work used 5 wt% potassium sulfate ( $K_2SO_4(aq)$ ), 5 wt% sodium chloride ( $NaCl(aq)$ ), and 1 M sulfuric acid ( $H_2SO_4(aq)$ ) for corrosion performance, as a continuation of the author's and co-worker's work.

## 2 Materials and Method

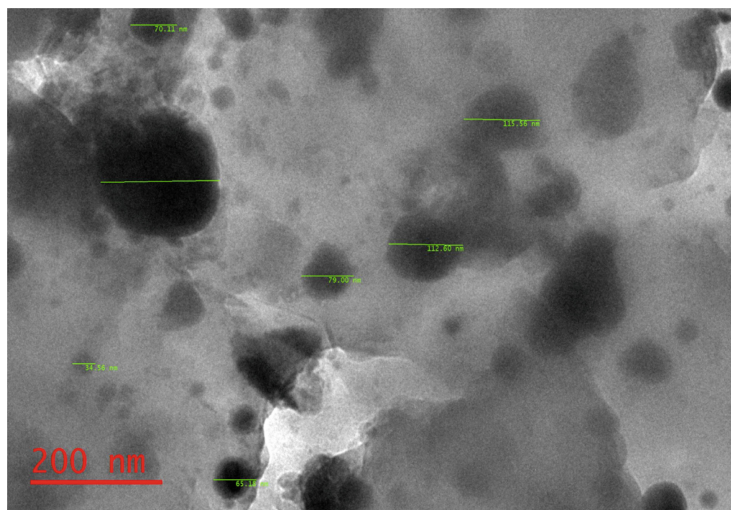
Mild steel of 0.15%C composition was grounded with a series of grit papers (240–1200PC) and inserted in a 2.9 wt.% hexafluorozirconic acid solution for a period of 1 h. The orange fruit was washed, cleaned, and pasteurized for 2 h at a temperature of 85°C, and the orange juice was then activated in steam at 65°C [12]. The sol-gel method was used in the production of the rice husk nanoparticles (RHnp) using a 35% sodium hydroxide solution. Details of the production procedure are discussed elsewhere [12]. LY556 (HERENBA BRAND) Epoxy and HY951 Hardener were used in the production of the epoxy coating. The modification of the epoxy was done using fluorinated poly(aryl ether ketone) (FPEK). The modified epoxy: hardener ratio of 2: 1 and 2%RHnp was used in the production of the epoxy composite coating. The epoxy was then mixed with 10ml of orange juice to help disperse the RHNP. A spray pyrolysis machine operating at 250rpm was used to deposit the mixture on the mild steel surface. The coated sample was cured on the laboratory floor for 24 h. The particle size of the RHnp was determined using the transmission electron microscope model (JEOL JSM840A). The microstructure was done using TESCAN SEM. A new corrosion tester model CHI604E was used for the electrochemical analysis at potentials of  $-1.5V$  to  $1.5V$  and  $0.0012V s^{-1}$ . The chloride-based road salt, heavy industrial pollution conditions, and heavy rain conditions were used in this study with 5 wt% potassium sulfate ( $K_2SO_4(aq)$ ), 5 wt% sodium chloride ( $NaCl(aq)$ ), and 1 M sulfuric acid ( $H_2SO_4(aq)$ ). The polarization resistance was computed using Eq. 1 [2].

$$R_p = \frac{\beta_a \beta_c}{2.3icorr(\beta_a + \beta_c)} \quad (1)$$

$\beta_a$  = Tafel anodic constant,  $\beta_c$  = cathodic Tafel constant

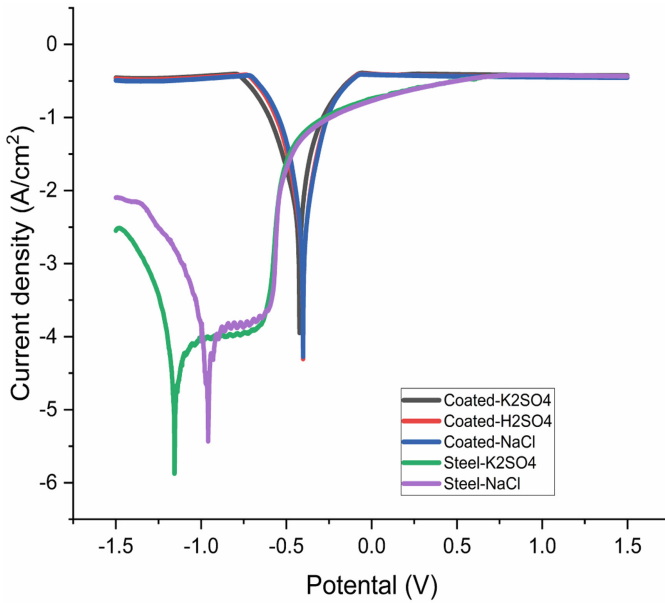
### 3 Results and Discussion

Figure 1 displays the TEM image of the RHnp. It was observed that segregation and particle clustering were not seen in the TEM image. However, random distribution of fine particles was observed these were attributed to the reducing ability of the orange juice that prevents particle clusters. A similar observation was obtained in the work of [4]. An average particle size of 31.94–70.99 nm was obtained.



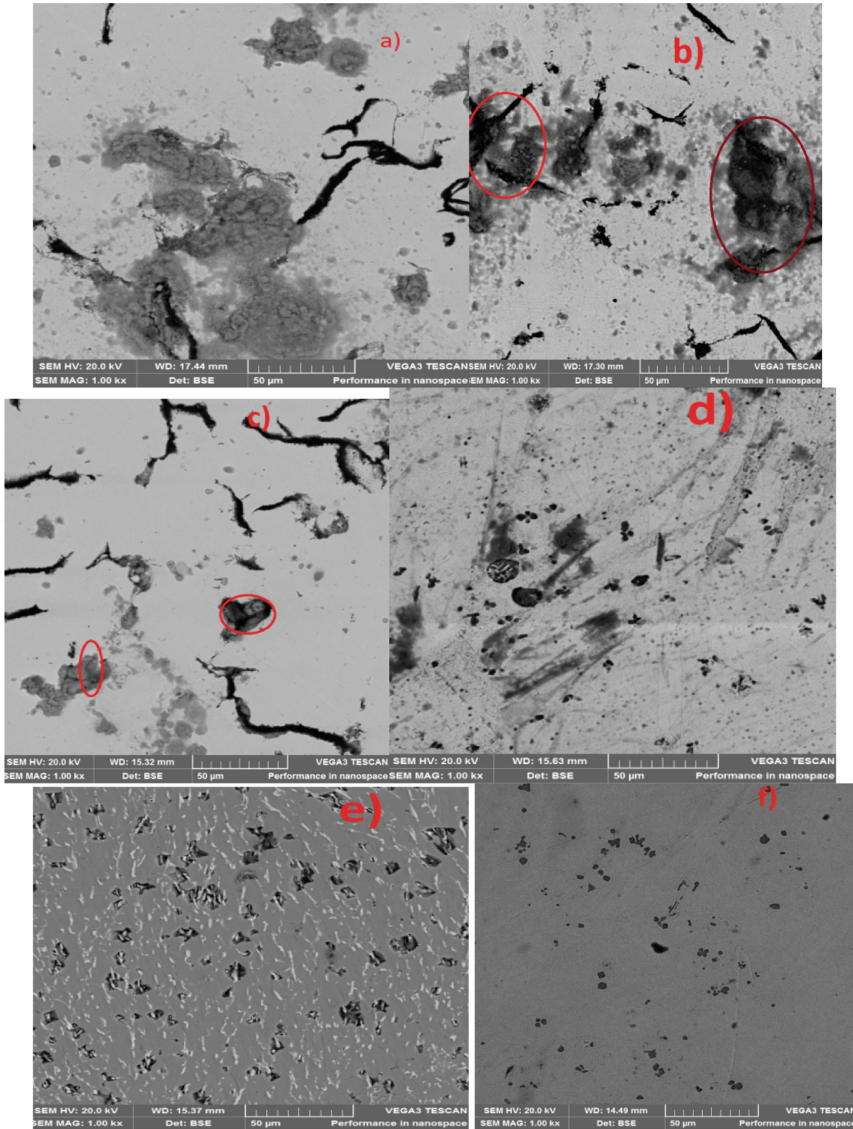
**Fig. 1.** TEM image of the pasteurized and activated rice husk ash nanoparticle

Figure 2 shows the results of the corrosion analysis. It was observed that the coated samples shifted the potential to a more positive one. There is a very significant difference in the Tafel plot of the coated and that of the mild steel samples. The coated samples' potentials were shifted to higher potentials and lower current density. The coated 5% NaCl sample has a higher potential and hence a lower corrosion rate. The mild steel samples have the lowest potential of all the samples. It was observed that the %wt% $K_2SO_4$  (aq) has a higher tendency of corrosion as a result of the lower potential, but the developed composite has a higher potential and shifted the Tafel curves to the right in the three media under investigation. The higher rate of corrosion experience for the mild steel sample could be attributed to the fact that iron oxidation and change in pH values are the major factors affecting the corrosion behavior of this cast iron. At work, corrosion rates of 3200, 2015 and 1016 mpy were obtained for the substrate, while the coated sample corrosion rates of 678, 567 and 456 mpy were obtained for  $K_2SO_4$ ,  $H_2SO_4$  and NaCl, which corresponded to 78.81, 71.86 and 55.11%.



**Fig. 2.** Tafel polarization plot of the electrochemical process

Figure 3 displays the corroded surfaces of the samples. There was a great difference in the corroded surface of the mild steel as compared with that of the coated samples. The formation of passive films was noticed in coated samples. The passive films covered the sample surface and increased the potential of the composite sample to lower degradation by corrosion. However, the composite sample in 5wt%NaCl has the higher passive film. This is the main reason the composite sample in 5wt%NaCl has the higher corrosion resistance due to the high amount of corrosion product in the form of nodules as evidenced.



**Fig. 3.** Corroded surfaces of mild steel in (a)  $K_2SO_4$ , (b)  $H_2SO_4$ , and (c)  $NaCl$ . d)  $K_2SO_4$  coated, b)  $H_2SO_4$  coated, c)  $NaCl$  coated

## 4 Conclusions

New insights in using orange juice as a reducing agent to functionalize the rice husk ash nanoparticle for epoxy coating of mild steel have been experimentally determined in this work. It was concluded that orange juice was able to enhance the dispersion of RHnp in the epoxy coating. 78.81, 71.86, and 55.11% corrosion resistance of the samples of

$K_2SO_4$ ,  $H_2SO_4$ , and  $NaCl$  2wt%. The work finds out that the formation of nanostructure and functionalization with orange juice helped increase the purity of the silica content of the ramp. The presence of citrate ions in the orange juice acts as a stabilizer and reducing agent, which was attributed to the fine grain size and good corrosion resistance of the composite coating.

## References

1. Ramezanzadeh, B., Arman, S.Y., Mehdipour, M.: Anticorrosion properties of an epoxy zinc-rich composite coating reinforced with zinc, aluminum, and iron oxide pigments. *J. Coatings Technol. Res.* **11**(5), 727–737 (2014)
2. El Sockary, M.A., et al.: A new double layer epoxy coating for corrosion protection of petroleum equipments. *Int. J. Eng. Res. Appl.* 65–73 (2014)
3. Yu, H.J., Wang, L., Shi, Q., Jiang, G.H., Zhao, Z.R. and Dong, X.C.: Dong study on nano- $CaCO_3$  modified epoxy powder coatings. *Prog. Organic Coating* **55**, 296–3000 (2006)
4. Xia, S.Q., Wang, L.G., Wang, E.Z., Yue, X., et al.: Study on the wear resistance of  $Al_2O_3$  particles reinforced epoxy resin composite coating. In: *Advanced Materials Research*, vol. 821–822, pp. 1148–1151 (2013)
5. Ge, T., et al.: Design alternate epoxy-reduced graphene oxide/epoxy-zinc multilayer coatings for achieving long-term corrosion resistance for Cu. *Mater. Des.* **186**, 108299 (2020)
6. Shi, X., Nguyen, T.A., Suo, Z., Liu, Y., Avci, R.: Effect of nanoparticles on the anticorrosion and mechanical properties of epoxy coating. *Surf. Coat. Technol.* **204**, 237–245 (2009)
7. Pham, G.V., Trinh, A.T., To, T.X.H., Nguyen, T.D., Nguyen, T.T., Nguyen, X.H., et al.: Incorporation of  $Fe_3O_4/CNTs$  nanocomposite in an epoxy coating for corrosion protection of carbon steel. *Adv. Nat. Sci.: Nanosci. Nanotechnol.* **5**, 035016 (2014)
8. Bakhshandeha, E., Jannesaria, A., Ranjbarb, Z., Sobhania, S.: Mohammad Reza Saebaa, Anti-corrosion hybrid coatings based on epoxy–silica nano-composites: toward relationship between the morphology and EIS data. *Prog. Org. Coat.* **77**, 1169–1183 (2014)
9. Borsoia, C., Scienzab, L.C., Zatterac, A.J.: carlos arthur ferreira effect of the incorporation of micro and nanocellulose particles on the anticorrosive properties of epoxy coatings applied on carbon steel. *Mater. Res.* **21**(6), e20170269 (2018)
10. Valença, D.P., Alves, K.G.B., Melo, C.P.D., Bouchonneau, N.: Study of the efficiency of Polypyrrole/ $ZnO$  nanocomposites as additives in anticorrosion coatings. *Mater. Res.* **18** (supl.2), 273–278 (2015)
11. Aigbodion, V.S.: Explicit simultaneous enhancement of adhesion strength and wear resistance of functional value-added epoxy-functionalized rice husk ash nanoparticle composite coating. *Int. J. Adv. Manuf. Technol.* **109**(7–8), 2205–2214 (2020). <https://doi.org/10.1007/s00170-020-05758-0>
12. Jha, A.K., Kumar, V., Prasad, K.: Biosynthesis of metal and oxide nanoparticles using orange juice. *J. Bionanosci.* **5**, 162–166 (2011)




**Open Access** This chapter is licensed under the terms of the Creative Commons Attribution 4.0 International License (<http://creativecommons.org/licenses/by/4.0/>), which permits use, sharing, adaptation, distribution and reproduction in any medium or format, as long as you give appropriate credit to the original author(s) and the source, provide a link to the Creative Commons license and indicate if changes were made.

The images or other third party material in this chapter are included in the chapter's Creative Commons license, unless indicated otherwise in a credit line to the material. If material is not included in the chapter's Creative Commons license and your intended use is not permitted by statutory regulation or exceeds the permitted use, you will need to obtain permission directly from the copyright holder.





# Supply Chain Reconfiguration as an Option to Mitigate Post Harvest Losses and GHGs: Simulating a Case Study from Banana Supply Chain in Sri Lanka

M. K. D. C. K. Chandrasiri<sup>1</sup> , U. S. S. Dharmapriya<sup>1</sup> , A. K. Kulatunga<sup>1</sup> ,  
R. M. R. N. K. Ratnayake<sup>2</sup>, W. M. C. B. Wasala<sup>2</sup>, and W. A. P. Weerakkody<sup>2</sup>

<sup>1</sup> University of Peradeniya, Peradeniya, Sri Lanka  
chandrasirichethana@gmail.com

<sup>2</sup> National Post Harvest Management of Sri Lanka, Anuradhapura, Sri Lanka

**Abstract.** Zero hunger is one of the top three goals of Sustainable Development Goals which is achievable by reducing the postharvest losses of the food supply chain and improving food security. In developing countries approximately 40% of fruit harvest goes to waste due to not having proper mechanisms, coordination and best practices and poor post-harvest management. A pilot study has found post-harvest losses of fresh fruits and vegetables occur in 2.29%, 1.57%, 6.22% and 7.89% at farmer, collection center, wholesaler and retailer respectively, emphasizing the need of a reconfiguration. Following good practices in handling, introducing suitable bulk packing methods, vehicle upgrades and development of different supply chain configurations are some approaches in mitigating post-harvest losses. Therefore, it is timely to change the product flow of supply chain by reconfiguration. The existing configuration of fruit and vegetable supply chain is simulated as an agent based simulation model taking banana supply chain as a case study. Short supply chain branches were introduced as suggestions to avoid the congestion and banana getting exposed to mechanical damages. The reconfigured supply chain emitted 10% less GHG than the existing banana supply chain while achieving the efficiency in distribution flow.

**Keywords:** Reducing PHL · Supply chain reconfiguration · Agent based simulation

## 1 Introduction

Sri Lanka has been ranked 66<sup>th</sup> among 113 countries in the Global Food Security Index in 2019. In Sri Lanka the annual loss of fruit during domestic production has been reported about 210,000 metric tons, worth about US\$90 million [1]. Postharvest losses (PHL) frequently occurred when packing, transporting, handling, harvesting, distributing, storage, production and retailing. To mitigate PHL, experts have suggested supply chain actors following good practices in handling, using suitable bulk packing methods, vehicle upgrades such as controlling systems, and supply chain reconfigurations to mitigate PHL.

© The Author(s) 2023

H. Kohl et al. (Eds.): GCSM 2022, LNME, pp. 1044–1052, 2023.

[https://doi.org/10.1007/978-3-031-28839-5\\_116](https://doi.org/10.1007/978-3-031-28839-5_116)

### 1.1 Different Supply Chain Configurations

Sri Lankan fruit and vegetable (F & V) supply chain mainly functioning as traditional and modern (supermarket) F & V supply chain channels. Commission system and periodical (fairs) system are minor operating supply chain channels [1] in Sri Lanka Table 1 provides a descriptive summary of the different supply chain channels.

**Table 1.** Existing different supply chain configurations.

Supply chain channel	Description
Traditional	<ul style="list-style-type: none"> <li>• Composed with small scale farmers</li> <li>• Value/non-value adding activities at intermediaries</li> <li>• Different configurations with slight geographical and operational variations (Fig. 1)</li> </ul>
Super market	<ul style="list-style-type: none"> <li>• Includes super market collection centers and central processing warehouse</li> <li>• Proportion purchased is very low</li> <li>• Low quality products are sold to traditional supply chains</li> <li>• During the market gluts, purchasing from the traditional supply chain</li> <li>• Transportation and overhead cost is high, cost due to damage is low [2]</li> </ul>
Commission system	<ul style="list-style-type: none"> <li>• Contact commission agents in Manning market (Colombo) and supply by transport agents</li> <li>• Farmers get paid by the commission agents</li> <li>• The product ownership is not transferred to the transport agent. (They are not accountable for the PHL occurred)</li> <li>• The PHL is deducted from the farmer</li> </ul>
Periodical system	<ul style="list-style-type: none"> <li>• After supplying to the main distribution channels, the remainder is sold at the local fair</li> </ul>

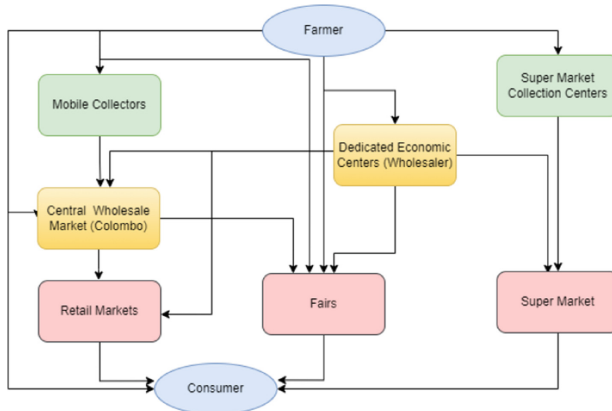
The different ways of product flow between the intermediaries create different supply chain channels. increased number of intermediaries makes the supply chain more complex while increasing the PHL leading to low profitability for farmers and higher prices for consumers [1]. Table 2 Provides detailed summary of the intermediaries and their characteristics.



**Table 2.** Intermediaries involved in the existing supply chain structures.

Intermediaries	Characteristics
Collectors (Mobile/Centers)	<ul style="list-style-type: none"> <li>• Buy from small scale farmers and distribute to DEC's, whole sale markets and retail fairs</li> <li>• Mobile collectors visit, harvest and purchase the crop or distribute to collection centers</li> <li>• When mobile collectors involved loss is comparatively low</li> </ul>
Dedicated Economic Centers (DEC)	<ul style="list-style-type: none"> <li>• Majority of the F &amp; V s are distributed via 12 DEC's scattered across the island</li> <li>• Transferred to another DEC's, whole sale market or a retailer</li> </ul>
Central Wholesale Market (Manning Market)	<ul style="list-style-type: none"> <li>• Connecting the DEC's all over the country [3]</li> <li>• Farmers, collectors and DEC's supply F &amp; V to the central wholesale market and dispatched to retail markets and fairs</li> </ul>
Super Market Collection Center	<ul style="list-style-type: none"> <li>• Only a limited number of farmers who regularly supply and who are located closer have the direct access</li> <li>• High buying price if meet the high quality requirement</li> </ul>
Central Processing Warehouse	<ul style="list-style-type: none"> <li>• Operated by major supermarkets</li> <li>• Super market collection centers transport F &amp; V to the central processing warehouse to store</li> <li>• Sorting, grading, weighing and packing is done before dispatching to super markets [4]</li> </ul>
Fairs/road side shops	<ul style="list-style-type: none"> <li>• Directly supply to the consumers</li> </ul>

At present, numerous different configurations exist as given in Fig. 1. One third of the total F & V in Sri Lanka is handled through farmer – DEC – retailer market – consumer matrix, 20% through farmer – wholesaler – retailer - consumer marketing channel, 3% via local fairs and only 1% via supermarket channels [5]. Since high portion of the fruits and vegetables are reaching the consumers through the traditional channel, high impact can be made by reconfiguring. This study ultimately proposes reconfiguration of the supply chain to change the mode of operations. Initially, the existing supply chain of a selected fruit (banana) will be modeled as an agent based simulation model. Then the identified bottlenecks will be addressed by a reconfigured supply chain model.



**Fig. 1.** Existing F & V Distribution Channels.

## 2 Background Study

PHL estimations, their occurrences and major influencing factors for PHL have been widely studied all over the world. In Ethiopia, banana PHL was estimated as 26.5% and out of it 56%, 27% and 17% occurred in retail, wholesale and farm levels respectively [6]. Cross-sectional analysis to determine the extent and factors influencing PHL in the cooking banana value chain in Uganda has found that 14.9% of banana suffer PHL, 7.2% completely and 7.7% partially [7]. Carbon footprint is frequently studied in related to F & V supply chain. A study of greenhouse gas emission of bananas from cradle to retailer and cradle to grave has found overseas transport and primary production are the main contributors of total GHG emissions [8]. Considering the fact that banana is one of the most important crops in the world, none of the studies have done related to banana supply chain reconfiguration in order to reduce PHL, GHG emission and achieve operational efficiency.

Even bananas are the widely cultivated and highest selling fruit crops in Sri Lanka [6], only a handful of studies have investigated different aspects of banana supply chain over last two decades [7]. The long term trends in extent, production and cost of cultivation have been studied of the banana sector in Sri Lanka [8]. Value chain concept has been utilized to analyze the situation (characteristics, inefficiencies) of banana industry in 2016 [9, 10]. PHL have been quantified in sour banana supply chain and associate climate impacts have been estimated using life cycle analysis approach [7]. The waste streams and causes of waste have been identified and solution frameworks have been suggested to minimize those wastes and to improve quality and safety of banana [11]. Appropriate bulk packaging system for banana bulk transportation has been introduced to reduce PHL due to mechanical damages in Sri Lankan distribution channels [12]. None of the studies have been done reconfiguring the banana supply chain to reduce PHL and GHG emission. This study aims proposing a reconfiguration of the supply chain to change the mode of operations.

### 3 Methodology

#### 3.1 Data Collection

The study covered two major banana supply chain branches; starting from farmer fields at Embilipitiya (Southern province) and Thambuttegama (North Central province) which are terminating at the retail markets of Colombo, Gampaha (Western province), Kandy (Central province), Badulla (Uva province) and Balangoda in (Sabaragamuwa province). For this study, randomly selected farmers were given questionnaires and finally, 20 and 10 farmers were selected from Embilipitiya and Thambuththegama respectively due to the complete information provided. From these farmers data regarding their production, collection, distribution, mode of transportation and quantity, wastages, storage capacity, selling price, buying price, waiting time at each stakeholder, number of routes, vehicle capacity and travelling distance at each stake holder were collected through field surveys, observations and personal interviews. According to the data obtained, Embilipitiya and Thambuththegama banana supply chains were simulated.

#### 3.2 Selection of Simulation Technique

To observe the impact of each supply chain entities, the existing operations and where the improvements are required the agent based simulation method can be adopted by taking farmers, collectors, DEC centers, wholesalers and retailers as agents.

#### 3.3 Banana Supply Chain Case Study

Initially, the existing banana supply chain is simulated as an agent based simulation model on "Simio 14" for a week and the performance measures in terms of the PHL, GHG emission (kgCo2eq) and lead time of the current banana supply chain are discussed. Then to mitigate GHG emission and PHLs them the existing banana supply chain is reconfigured and the performance measures of the new configuration are compared with the existing banana supply chain.

A kilogram of banana is considered as one entity which is traversing through the simulation model. Cultivation areas have been taken as sources, and farmers, collection centers, DEC, wholesalers and retailers have been taken as servers. From the retailer markets, the entities are passing to the sinks which are referred to the consumers. Sources, servers and sinks are connected by paths drawn according to the actual distance scale.  $EF_i$ ,  $F_i$ , ECC, TCC, EW, TW,  $EFV_i$  and  $TFV_i$  were referred to, Embilipitiya  $i^{\text{th}}$  farmers,  $i^{\text{th}}$  farmer, Embilipitiya collection center, Thambuttegama Collection Center, Embilipitiya wholesaler, Thambuttegama wholesaler, Embilipitiya farmer's  $i^{\text{th}}$  vehicle, Thambuttegama farmer's  $i^{\text{th}}$  vehicle respectively.

### 4 Results and Discussion

When the farmers delivering banana to the collection centers/DEC, the payment is made for the total banana weight. Therefore, they overload the vehicle and try to deliver

maximum at once, eventually increasing PHL. According to the pilot study conducted it was found that, the second most banana PHL is occurring at the wholesale point followed by the collection center [9]. Since most of the farmers and mobile collectors deliver banana lots to the collection centers/DECs in the morning, there is a huge congestion. In the existing banana supply chain, entire amount of banana is going through collection center, wholesaler and then to different retailers while exposing to PHL at each point.

To overcome these issues,

- The small scale farmers are encouraged to use the collection center vehicle or a mobile collector rather than taking individual vehicles.
- Large scale farmers are encouraged to supply their ripen banana directly to the wholesaler.
- Collection centers are encouraged to supply the over-ripen banana directly to the retailers.

When mobile collectors involve, who follow the good post-harvest handling practices the PHL are comparatively low. The large scale farmers supplying the over ripen bananas directly to the wholesaler to avoid the congestion at collection center. Letting the collection centers directly supply the over ripen banana to retailer market is another strategy to reduce congestion and PHLs at wholesale. Here, in the improved version, all the banana lots are not traversed through the same route. Yellow color demarcated vehicles are used to collect banana in a defined route. Figure 3 contains direct paths from the Embilipitiya and Thambuttegama collection centers to Colombo retail market. Other than that, large scale farmers are directly supplying the wholesale markets. Since the loading and unloading is lesser, the probability of banana exposing to PHLs can be reduced (Fig. 3).

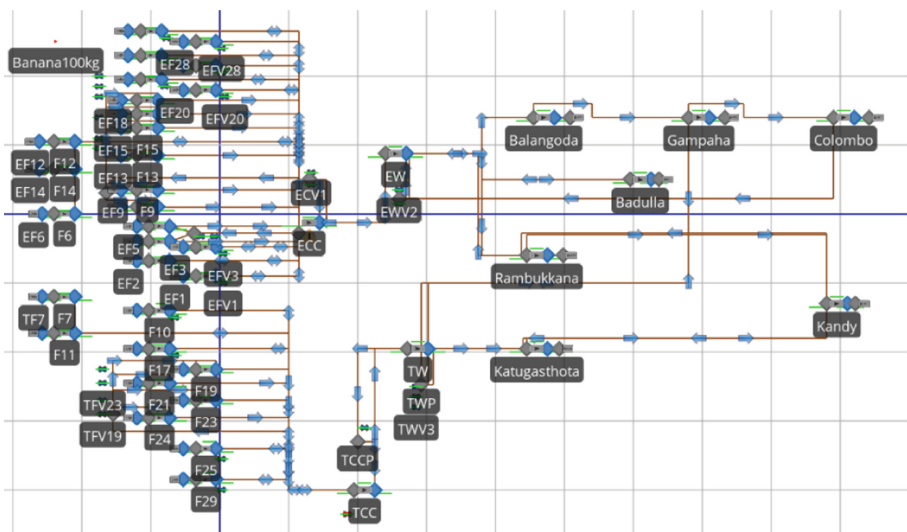


Fig. 2. Existing Banana Supply Chain.

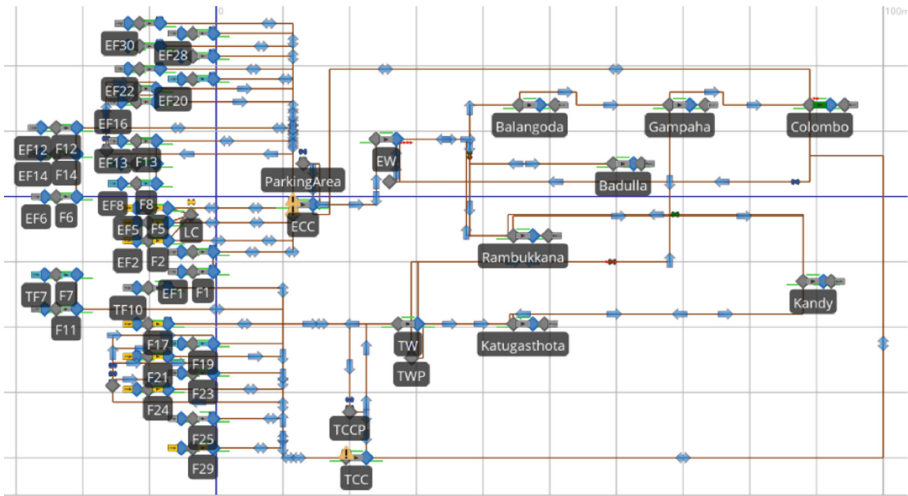


Fig. 3. Suggested Banana Supply Chain.

Table 4. GHG emission comparison of the existing and suggested banana supply chains.

Stage	Existing Banana SC				Proposed Banana SC			
	PHL (kg)	Net GWP (kgCO <sub>2</sub> eq)		PHL (kg)	Net GWP (kgCO <sub>2</sub> eq)		PHL (kg)	
		Production	PHL	Transport		Production	PHL	Transport
Farmer	31.5	272.79	8.82		31.5	272.79	8.82	
Farmer to Collector				16.3				10.43
Collector	21.6		6.04		21.5		6.01	
Collector to Wholesale				9.10				59.00
Wholesale	85.6		23.97		42.28		11.84	
Wholesale to Retailer				149.94				73.63
<b>Total</b>		<b>486.96</b>				<b>442.52</b>		

Here, GWP when transporting and at each supply chain intermediate point as PHL were calculated as bellows [9];

GWP (transporting) = ton-kilometers x emission factor  
 GWP (Organic waste) = 0.28 kgCO<sub>2</sub>(eq)kg<sup>-1</sup> x Organic waste  
 GWP (Production) = 0.206 kgCO<sub>2</sub>(eq)kg<sup>-1</sup> x Production quantity

Table 4 summarizes the variability of the GHG emission and PHLs between the existing and the suggested banana supply chain configurations. The proposed configuration emits 10% of GHG less than the existing structure. Only when transporting banana from collection center to wholesale, as the over ripen banana portion is suggested to directly supply to the retailers, the distance has increased and proportionally the GHG emission has been increased. As the pilot study [9], reported high percentage of PHL at wholesaler and while transporting from wholesaler to retailer points and to reduce the high congestion there, the short supply chain branches are introduced. The average traverse time has reduced by 24.27% in the proposed solution. Since the GHG emission is proportional to travel distance and the travel distance is higher in the suggested configuration, altering this scenario encouraging each stake holder to supply to the nearest location, merging with other high capacitated transport modes rather than limiting to own transport modes with less capacity will further reduce the GHG emission being cost effective at the same time.

## 5 Conclusion

Operational efficiency has been achieved by re-configuring supply chain with less PHL and GHG emission. Introducing the short supply chain branches for ripen and over-ripen banana, adding transport capacity to wholesaler and optimum vehicle utilization were the suggested improvements. Reducing possibility of banana lots exposing to PHL while transporting and processing, the GHG has been reduced by 10% increasing the banana distribution flow and the flow efficiency of reaching the retailer markets.

This simulation is only based on static routing behaviors which can be pointed out as a limitation. This can be further extended by introducing dynamic routing behaviors in different scenarios. The simulation model can be integrated with the consumption rate at each retail market and by adding emission at each supply chain stage and vehicles incorporated. Path optimizing where the GHG, PHL and efficiency is optimized is yet to study. Vehicle capacity optimization methods for banana can be introduced to minimize the waste during transportation as a future study.

**Acknowledgements.** Global Research Alliance and Ministry of Primary Industries of New Zealand, National Post Harvest management of Sri Lanka.

## References

1. Annual Report 2020 (2020)
2. Chandana, D., Rahman, F., Ramachandran, P.: Supply chain management of fruit and vegetable industry in Sri Lanka, Electron. Theses Diss. (2007)
3. Samarasinghe, Y.M.P., Kumara, B.A.M.S., Kulatunga, A.K.: Traceability of fruits and vegetables supply chain towards efficient management: a case study from Sri Lanka. *Int. J. Ind. Eng. Oper. Manag.* **03**(02), 89–106 (2021). <https://doi.org/10.46254/j.ieom.20210203>

4. Abeysekara, T., Abeysekara, S.: Alternative supply chain management practices and the performance of marketing channels in fresh fruit and vegetable marketing in Sri Lanka. In: Proceedings of the International Symposium on Fresh Produce Supply Chain Management, pp. 135–147, December 2015. <ftp://ftp.fao.org/docrep/fao/010/ah996e/ah996e03.pdf>
5. Wijesinghe, P., Wickramasingha, R., Kuruppu, V.: Factors influencing vegetable farmers' decisions (2021)
6. Mebratie, M.A., Haji, J., Woldetsadik, K., Ayalew, A.: Determinants of postharvest banana loss in the marketing chain of central Ethiopia. *Food Sci. Qual. Manag.* **37**, 53–63 (2015)
7. Kikulwe, E.M., Okurut, S., Ajambo, S., Nowakunda, K., Stoian, D., Naziri, D.: Postharvest losses and their determinants : a challenge to creating a sustainable cooking banana value chain in Uganda. *Sustainability* 1–19 (2018). <https://doi.org/10.3390/su10072381>
8. Svanes, E., Aronsson, A.K.S.: Carbon footprint of a Cavendish banana supply chain. *Int. J. Life Cycle Assess* (2013). <https://doi.org/10.1007/s11367-013-0602-4>
9. Kamalakkannan, S., et al.: Life cycle assessment of food loss impacts: case of banana postharvest losses in Sri Lanka. *Procedia CIRP* **105**, 859–864 (2022). <https://doi.org/10.1016/j.procir.2022.02.142>
10. C.P. Hathurusinghe and Hector Kobbekaduwa Agrarian Research and Training Institute: A study on value chanin [i.e. chain] of pineapple and banana in Sri Lanka, no. March 2012
11. Vidanagama, J., Piyathilaka, M.D.: Enhancement of Product Quality and Resource Efficiency of Sri Lankan Banana Supply Chain, no. August 2015, pp. 0–11 (2011)
12. Wasala, W.M.C.B., Dharmasena, D.A.N., Dissanayake, T.M.R., Thil-akarathne, B.M.K.S.: Vibration simulation testing of banana bulk transport packaging systems. *Trop. Agric. Res.* **26**(2), 355 (2015). <https://doi.org/10.4038/tar.v26i2.8098>

**Open Access** This chapter is licensed under the terms of the Creative Commons Attribution 4.0 International License (<http://creativecommons.org/licenses/by/4.0/>), which permits use, sharing, adaptation, distribution and reproduction in any medium or format, as long as you give appropriate credit to the original author(s) and the source, provide a link to the Creative Commons license and indicate if changes were made.

The images or other third party material in this chapter are included in the chapter's Creative Commons license, unless indicated otherwise in a credit line to the material. If material is not included in the chapter's Creative Commons license and your intended use is not permitted by statutory regulation or exceeds the permitted use, you will need to obtain permission directly from the copyright holder.





# Design of a Sustainable Rescue and First Aid Drone-Based System for Passenger Car Occupants

Marvellous Moyo<sup>1</sup>, Tawanda Mushiri<sup>1,2(✉)</sup>, and Habib Noorbhai<sup>2</sup>

<sup>1</sup> Department of Biomedical Informatics and Biomedical Engineering, Faculty of Medicine and Health Sciences, University of Zimbabwe, Mt Pleasant, P. O Box MP167, Harare, Zimbabwe  
tmushiri@medsch.uz.ac.zw

<sup>2</sup> Biomedical Engineering and Healthcare Technology (BEAHT) Research Centre, Faculty of Health Sciences, University of Johannesburg, Johannesburg, South Africa

**Abstract.** Medical emergencies transpire in passenger cars where most victims fail to access immediate medical assistance bringing about worsening of their health or death. Incorporation of rescue and first aid drone-based systems in Emergency Medical Services has been proposed. The objectives being improving response time of Emergency Medical Services, assessing the victim's health, assisting in administration of first aid, real time live feed of victim's vitals to the responders and mainly to outline how sustainability in healthcare can be achieved through adaptation of the proposed system. The key features of the first aid drone-based system include: a compact, architecture, aerodynamically optimized architecture and high strength to weight ratio. Solid Works has been used for modelling and simulation of the proposed system. Results showed that the maximum stress (295MPa) experienced in the link is less than the yield strength of carbon fiber (1000MPa), therefore, the design is safe. Findings also showed that, the proposed system can help to further bridge the gap between technology and healthcare, hence making the current healthcare system more relevant in future. Recommendations have been made on improving the software design of the system. Further studies on the design of quadcopters with high range, payload, endurance and speed has been proposed. Overall, the research focused on how robotics, Artificial Intelligence, and Internet of Things (Industry 4.0) can be used to improve Emergency Medical Services response to health emergencies.

**Keywords:** Artificial Intelligence · Emergency Medical Services · First Aid · Health Emergencies · Industry4.0 · Internet of Things · Passenger Car · Robotics · Sustainability

## 1 Introduction

According to statistics of the World Health Organization, each year, approximately 1.35 million people's lives are cut short because of road traffic accidents [1]. The initial 10 min, as indicated by some specialists, are named as 'Platinum Time' in response to accidents



[2]. Though every victim's severity of the injury and introductory clinical treatment, alongside the minimum time expected to save their life, may vary, accomplishing this minimum time is of utmost importance. The road is the most used mode of transport when responding to road traffic accidents. However, time taken by the emergency services to attend victims of accidents is prolonged by a lot of factors such as road traffic and poor conditions [3]. Therefore, there is a need to develop not only more efficient emergency rescue system but sustainable frameworks as well. Well so long as motor vehicles are used, road traffic accidents will prevail. Thus, the design of a sustainable rescue and first aid drone-based system for passenger car occupants to be incorporated in Emergency Medical Services has been proposed.

Sustainability is the capacity to develop and execute technologies or strategies, which are self-sustaining without risking the potential for future generation to address their needs [4]. Robotics for sustainable development stays an intriguing challenge where research and healthcare in developed and undeveloped countries can both contribute and benefit [5]. The main merit of using sustainable robotic systems in healthcare is improved chances of accidents victims' survival, mainly during the golden hour [6].

## 2 Literature Survey

Unmanned Aerial Vehicles (UAV) are more properly known as drones [7] and in coalescence with Global Positioning System (GPS), the flying machine can be remotely controlled or fly autonomously by software-controlled flight trajectories in their embedded frameworks [8]. One of the recent designs in robotics is a quadcopter designed to adopt a manipulator [9]. **SOTA.**

### 2.1 Applications of Drones in Healthcare

Drones are used to monitor disaster sites, areas with biological and chemical hazards and track disease spread [7]. One of the most promising uses of drones is in the emerging field of telemedicine, the remote diagnosis and treatment of patients using telecommunications technology. Another use of drones in the medical field is delivery, for example, the ambulance drone designed by Alec Mormont, where in his version, a smartphone app is used to call the drone during an emergency. Researchers noted that the drone arrived more quickly than Emergency Medical Services (EMS) in all cases with an average response time of 16:39 min [3]. Note, compared to helicopters and airplanes drones are energy efficient and produce less noise.

### 2.2 Importance of First Aid in Road Traffic Accidents (RTA)

In the case of an accident, prompt help of bystanders can save lives and decrease damage to health. The International Federation of the Red Cross and Red Crescent Societies (IFRC) states that more than 50% of deaths from road traffic accidents transpire within the initial couple of minutes after the crash. In the case of cardiac arrest, the brain starts to die in the span of four minutes [10]. Each and every single minute decreases the possibilities of survival by 10%. In Europe, it takes roughly 8–15 min before the

emergency service arrives [11]. Numerous critical conditions have to be treated a lot quicker, so the assistance of bystanders is important. However, the number of individuals that have gone through first-aid training does not necessarily show an elevated degree of competencies, readiness to assist on the required level. Thus, an adaptation of drone technology is essential.

### **3 Materials and Methods**

#### **3.1 Developing Possible Solutions**

To select the optimal rescue and first aid drone-based system, Solid Works was used to develop three concepts. The first drone design was initially designed based on using the least number of materials to achieve the aims and objectives. Still, it consisted of frames attached to the motors leading to poor safety. The second concept was an improvement of the first concept, and this was achieved by inserting propeller guards there by enhancing safety. The third concept was developed based on making the strongest and safest arm design while still achieving all the objectives. This was achieved by adding a fuselage around the drone frames and propeller guards, thereby enhancing safety and aerodynamic efficiency.

#### **3.2 Concept Selection and Detail Design of Selected Concept**

A binary dominance matrix was used for selecting the optimal concept amongst the three and the third concept ranked number one and was selected for further development. The first step in designing the first aid drone was segment development for the whole machine. The following are the segments of the chosen design: first aid box, frame and propeller guards, robotic arm and actuation, software design, sensors, battery, circuit design and end effector.

#### **3.3 Determining the Minimum Length of the Robotic Arm**

The arm should perform first aid and assess the victim's health while they are still stuck inside vehicle or outside the vehicle. In the event they are inside the vehicle the arm should be of adequate length to reach all the victims inside the car. To make sure the arm has an adequate length, standard dimensions of common ten cars were considered. A Land Rover Defender with standard dimensions: 4758 x 1996 x 1967mm (longest width), was considered and hence, the length of the robotic arm should be at least greater than 1996mm.

#### **3.4 Static Structural Analysis**

To obtain the displacements, stresses and strains acting on the robotic manipulator components, finite element-structural analysis was done. Static simulation tool in Solid Works was used to perform the static structural analysis.

The Von Mises stress failure criterion was used for the stress analysis. The simulation results were done for the link experiencing the highest load, that is, link 1, see Table 1

**Table 1.** Loads acting on the robotic arm link

Member	Torque /Nm	Force /N	Safety factor	Critical load/N
Base link	13.49			
Link 1	8.79	25.17	1.5	37.76
Link 2	4.38	21.09	1.5	31.64
Link 3	1.25	16.22	1.5	24.33
Link 4		11.35	1.5	17.03

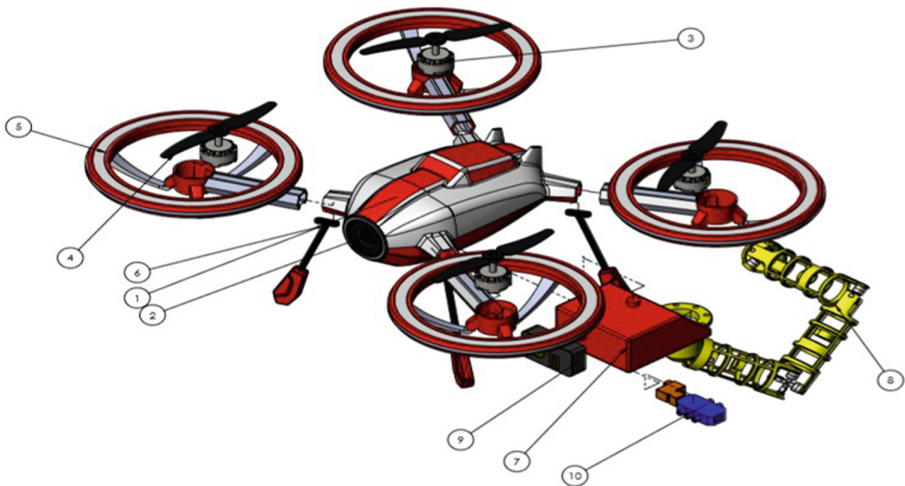
above. A vertical force of 37.7N was applied at the link front while the back was fixed, where the preceding link connects. Carbon Fiber was selected as the main drone material because of its high strength to weight ratio (density =  $1.6 \times 10^6 \text{g/m}^3$ ). Each link was assumed to be a hollow cylinder and mass determined using the following formula: Mass = Density  $\times$  Volume. The Table 1 below summaries forces and torques acting on each link derived from their masses. A safety factor of 1.5 was used to cater for the electrical and other auxiliary components.

## 4 Results and Discussions

The proposed systems consist of a six-link robotic manipulator, with six degrees of freedom, attached underneath a drone and for design simplicity, a quadcopter has been used. A pneumatic link which is the last link to be connected to the end effector, shown in Fig. 1 below, was adapted for performing Cardio Pulmonary Resuscitation (CPR) during system operation, and this is the unique part of this medical manipulator compared to those already in the market, though the gripper system design was not part of project scope. Precisely, the robotic arm's end effector application distinguishes it from other medical robots such the Da Vinci used in laparoscopy surgery. The system components include drone fuselage (1), camera (2), dc motor (3), propeller (4), propeller guards (5), landing gear (6), first aid box (7), the robotic arm (8), compressor (9) and valve (10), see Fig. 1 below. The general operation of the rescue and first aid drone system is summarized in the flow chart below, see Fig. 4. These include mainly performing first aid at the site and in addition normal rescue operations, such as in Alec Momont's ambulance drone [3]. These processes (see the flow chart) will be done while the EMS are on their way to the accident scene, and upon arrival, they can relieve the drone and take over the situation. Findings also show that, there is a need to incorporate a first aid drone to assist ambulances (EMS) during medical emergency rescue operations. In addition, one advantage over the defibrillator, is that the arm can perform CPR on anyone, as long as there are within the arm's reach and there is enough space for the arm to operate. Also, a small defibrillator can be added to the system to improve the overall efficiency by complementing the pneumatic link. From the simulation results, see Fig. 2 and Fig. 3, the maximum Von Mises stresses  $2.95 \times 10^8 \text{N/m}^2$  experienced in link 1, is way below the yield strength of the material ( $1.01 \times 10^9 \text{N/m}^2$ ) and the maximum displacement of the link is relatively small  $3.928 \times 10^{-1} \text{mm}$ . Therefore, the design is safe under the above loads.

#### 4.1 Achieving Sustainability in Healthcare: A Sustainable Rescue and First Aid Drone-Based System

The developed sustainable rescue and first aid drone-based system is of paramount importance when it comes to sustainability as a whole, that is, to achieve sustainability in healthcare and manufacturing industry such systems need to be adopted. As, a large portion of the rising worldwide consideration regarding air pollution centers around the effects that ozone, particulate matter and different toxins have on human health. The World Health Organization (WHO) predicts that air pollution inside and outside the house is answerable for around 7 million early deaths around the world [12]. Yet, more than one billion motorized vehicles are driven on the earth today. In the following twenty years, vehicle possession is expected to reach twofold around the world [13]. The quantity of motorized vehicles all over the planet is expected to yearly increment by 3% [14]. Established researchers trust that greenhouse gas emissions, particularly carbon dioxide (CO<sub>2</sub>), should be diminished by 50 to 80 percent by 2050 to balance out the climate and turn away economic and natural disasters [15].

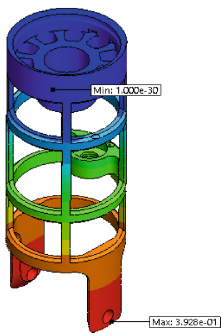


**Fig. 1.** First aid drone exploded view

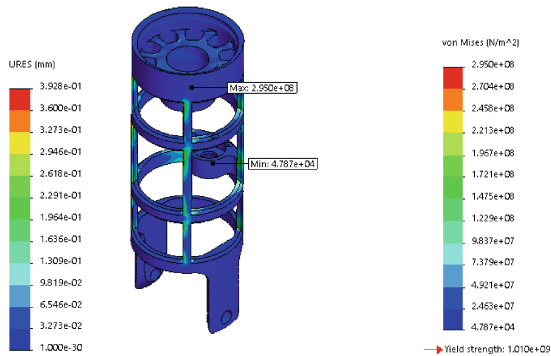
From the above preamble, the key statements to note is, cars are very reliable and efficient machines, the main problem is greenhouse gas emissions associated with the use of fuel and hence that is how the proposed system comes into play. Obviously, this rescue and first aid drone system will not replace cars but since it is a new system introduced to improve safety on roads and save lives. One might argue that vehicles, airplanes, and helicopters are there and some are even faster than the proposed system, well the difference is that this system also preserves the environment by not contributing directly to greenhouse gas emissions since it uses a battery instead of fuel. Also, note that batteries have a negative impact on the environment and their effect in drone applications is less compared to helicopters since helicopters use both larger batteries and fuel. Also,

recently environment friendly electric cars have been developed, so why this rescue and first aid drone? Aside from the relatively inexpensive cost of the rescue and first aid drone-based system compared to other emergency and rescue systems, more vehicles mean more traffic (one to two billion by 2040), and road development cannot stay up with growing mobility requests. The main objective of medical emergency systems, is to attend to emergencies as promptly as possible but by 2040 this might prove to be even a greater challenge for most road ambulances around the world. However, this will not be a hurdle for the rescue and first aid drone system, it flies. Thus, achieving sustainability in healthcare.

The WHO predicts that injuries associated with road traffic will ascend from their current ninth position in the cause-of-death to the fifth spot by 2030 – being responsible for 2.4 million deaths, as well as somewhere in the range of 20 and 50 million injuries, generally of young people, and at a huge expense for the economies [16]. With this in mind, it is pellucid that, emergency medical services must adopt very effective and efficient emergency medical systems to battle what is to come, such as the proposed rescue and first aid drone-based systems for passenger car occupants.



**Fig. 2.** Total deformation of link 1



**Fig. 3.** Stress distribution of link 1

Furthermore, by 2030 cities will be called smart, that is, they will be connected to everything through the use of Internet of Things (IoT) and some manufacturers are integrating new technologies such Artificial Intelligence, machine learning, cloud computing and analytics, into their production and all around their operations [17]. Although, these new technology systems have been adapted in healthcare as well, still a niche lacks, thus, the proposed system can help bridge the gap between technology and healthcare, hence making the current healthcare system, such as the robotic first aid system [18], more relevant in future. Further, note should be taken that the application of the sustainable rescue and first aid drone-based system is not limited to road traffic accidents only but can be used for all emergencies like cardiac arrest and heart attack. Also, in this regard, large industrial plants can adapt it to improve safety and save lives.

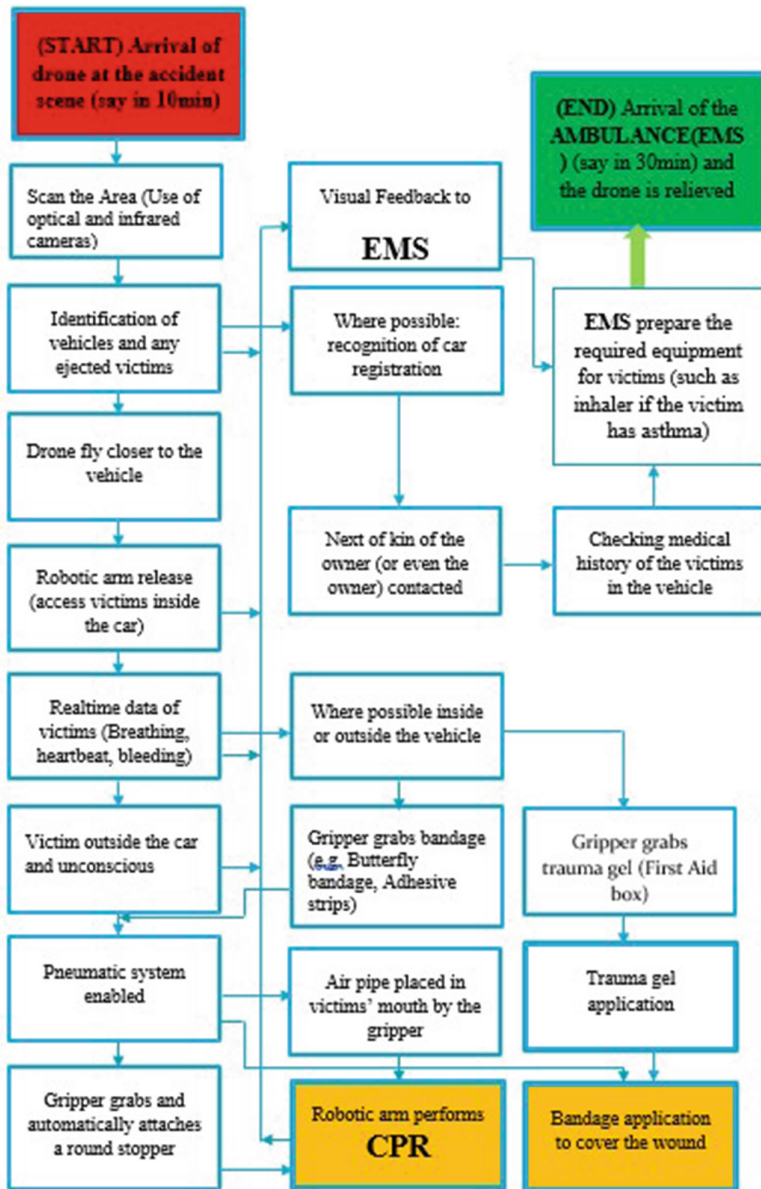


Fig. 4. Flow chart for the rescue and first aid drone-based system.

## 5 Limitations

The main sustainable rescue and first aid drone-based system's limitation is endurance, which is directly proportional to the drone battery life. At the same time, the whole processes associated with use of batteries has a huge impact on the environment and

hence a high effect on sustainability of the system. In addition, the methods used to dispatch the drone fully depends on respondents at the scene.

## 6 Recommendations and Conclusion

The first aid drone system is meant to be intelligent, and hence software design plays a pivotal role in the system function; thus, further research should be done on how to improve the AI of the whole system. In addition, further studies on the design of quadcopters with high range, endurance, payload and speed has been proposed.

This research's objective was to improve the response time, quality of first aid given to passenger car occupants case of medical emergencies and most of all to outline how sustainability in healthcare can be achieved through adaptation of the rescue and first aid drone-based system. It was against this background that the researchers proposed implementing the first aid drone to assist in conducting first aid and improving the response time of Medical Emergency Services. A model of a robotic arm has been designed, and Von Mises stress analysis was conducted using Solid Works. The research findings confirmed that adapting the rescue and first aid drone-based system, can help achieve sustainability in healthcare. From the research conducted so far, it can be shown that, the science and technology of this system are very sophisticated, but can and must be implanted, if we are to achieve sustainability in healthcare.

## References

1. Sminkey, L.: WHO | Global status report on road safety 2018, WHO (2019)
2. Qin, H., Liu, D., Chen, S., Lyv, M., Yang, L.: First-aid training for combatants without systematic medical education experience on the battlefield: establishment and evaluation of the curriculum in China, academic.oup.com (2020)
3. Caughill, P.: Life-saving drones can beat ambulances to heart attack victims (2017)
4. Busch, T., Bauer, R., Orlitzky, M.: Sustainable development and financial markets: old paths and new avenues. *Bus. Soc.* **55**(3), 303–329 (2016)
5. Baidya, R., Debnath, B., Ghosh, S.K., Rhee, S.W.: Supply chain analysis of e-waste processing plants in developing countries. *Waste Manag. Res.* **38**(2), 173–183 (2020)
6. Rogers, F.B., Rittenhouse, K.J., Gross, B.W.: The golden hour in trauma: dogma or medical folklore? *Injury* **46**(4), 525–527 (2015). <https://doi.org/10.1016/j.injury.2014.08.043>
7. Schuyler, T., Guzman, M., Schuyler, T.J., Guzman, M.I.: Unmanned aerial systems for monitoring trace tropospheric gases. *Atmosphere (Basel)* **8**(12), 206 (2017)
8. Pathania, A., Gangwar, D., Shivanshu, P., Angrish, A.: Unmanned aerial vehicle forensic investigation process: Dji Phantom 4 drone as a case study (2021)
9. Varadaramanujan, S., Sreenivasa, S., Pasupathy, P., Calastawad, S., Morris, M., Tosunoglu, S.: Design of a drone with a robotic end-effector (2017)
10. Martinez, A., Stapleton, O.: Field vehicle fleet management in humanitarian operations: a case-based approach, Elsevier (2011)
11. Pleskot, R., Štěpánek, K., Šímanovská, B., Nižňanský, M.: První pomoc zážitkem (Firstaid byexperience), ZDRSEM, Prague (internal methodical handbook) (2013)
12. Jerrett, M., et al.: Spatial analysis of air pollution and mortality in California. *Am. J. Respir. Crit. Care Med.* **188**(5), 593–599 (2013)
13. Glazebrook, G., Newman, P.: The city of the future, ssoar.info (2018)

14. Kagawa, S., et al.: Role of motor vehicle lifetime extension in climate change policy. *Environ. Sci. Technol* **45**(4), 1184–1191 (2011)
15. Posner, E.A., Weisbach, D.: *Climate Change Justice*. Princeton University Press, Princeton (2010)
16. WHO, Road traffic injuries (2021). <https://www.who.int/news-room/fact-sheets/detail/road-traffic-injuries>. Accessed 27 Apr 2022
17. Campisi, T., Severino, A., Al-Rashid, M.A., Pau, G.: Infrastructures the development of the smart cities in the connected and autonomous vehicles (CAVs) Era: From Mobility Patterns to Scaling in Cities, *mdpi.com* (2021)
18. Kurebwa, J., Mushiri, T.: A study of damage patterns on passenger cars involved in road traffic accidents, vol. 2019, pp. 22–24 (2019)

**Open Access** This chapter is licensed under the terms of the Creative Commons Attribution 4.0 International License (<http://creativecommons.org/licenses/by/4.0/>), which permits use, sharing, adaptation, distribution and reproduction in any medium or format, as long as you give appropriate credit to the original author(s) and the source, provide a link to the Creative Commons license and indicate if changes were made.

The images or other third party material in this chapter are included in the chapter's Creative Commons license, unless indicated otherwise in a credit line to the material. If material is not included in the chapter's Creative Commons license and your intended use is not permitted by statutory regulation or exceeds the permitted use, you will need to obtain permission directly from the copyright holder.





# **Student Projects**



# Leveraging Insights from Unique Artifacts for Creating Sustainable Products

H. Zannoun<sup>1</sup>(✉), J. Okorafor<sup>1</sup>, T. Asensio<sup>1</sup>, G. Guedes<sup>1</sup>, F. Badurdeen<sup>1</sup>, P. Wang<sup>1</sup>,  
I. S. Jawahir<sup>1</sup>, G. Campana<sup>2</sup>(✉), M. Mele<sup>2</sup>, and B. Cimatti<sup>2</sup>

<sup>1</sup> Institute for Sustainable Manufacturing (ISM) and Department of Mechanical & Aerospace  
Engineering, University of Kentucky, Lexington, KY, USA

hamzah.zannoun@uky.edu

<sup>2</sup> Department of Industrial Engineering, University of Bologna, Bologna, Italy

giampaolo.campana@unibo.it

**Abstract.** Sustainable manufacturing pursues the achievement of economic, environmental, and societal benefits by promoting the long-term use of materials, products, and components within a circular economy. The analysis of one-of-a-kind classical products reveal some designs that exhibit a creative combination of parts from a variety of industrial sectors. For example, Italian designers behind some innovative artifacts have managed to integrate components from different sources into attractive and emotional-oriented objects that are revered to this day. The present work aims to combine 6R-based sustainable manufacturing with insights gained from some classical products of Italian design characterized by simplicity and decontextualization of common objects. This manuscript presents the design process for leveraging concepts embodied in some unique artifacts from the Italian design movement to inspire the realization of sustainable products. A commercial household item was redesigned to demonstrate the application of the approach by utilizing end-of-life items collected from municipal solid waste. The potential benefits of the triple bottom line approach associated with leveraging concepts, such as those from Italian design, to develop more sustainable products is also discussed.

**Keywords:** Sustainable manufacturing · 6Rs · Italian design · Sustainable design

## 1 Introduction

The foundation of sustainable manufacturing (SM) is the triple bottom line (TBL): economic, environmental, and societal benefits. SM is achieved by means of the 6Rs: reduce, reuse, recycle, recover, redesign, and remanufacture, which enable closed-loop material flow [1]. Reuse and remanufacture are preferred strategies over recycling as it destroys most of the embodied energy (the resources invested into making products), but neither is possible without end-of-life (EoL) recovery strategies [1, 2]. One critical R that is most overlooked is redesign. The design/redesign stage dictates the extent to which closed-loop material flow is possible, and it requires thinking beyond a single

loop [3]. If a product is not designed to be recovered and recirculated from the outset, then it becomes harder to apply the 6Rs approach as 80% of costs and sustainability impacts are determined during design [4].

Besides, as the world becomes more urbanized, there is more consumption of manufactured products and an increase in waste when those products are disposed. Municipal solid waste (MSW) is defined as items that are discarded from residential and commercial sources, or materials that have lost their value to the holder [5, 6]. More than 292 million tons of MSW was generated in the U.S. alone in 2018, and only 38.2% of it was recycled or composted [7]. Thus, integrated waste management, which is the handling of waste in an economically and environmentally sustainable, socially acceptable manner, becomes paramount [5].

This study leverages insights from the discipline of Italian design (ID). While it is difficult to give a univocal definition of ID, it can be said that Italian designers consider three benefits when creating a product: functional, emotional, and symbiotic [8]. This is supported by Bosoni [9], who states that the Italian designer is “*the antithesis of the engineer or technician concerned only with function or production*”. Emotional and symbiotic benefits speak to the consumer on a level deeper than just the core functionality. This aspect of human nature is described by Verganti [10]: “*what matters to the user (in addition to the product’s functionality) is the product’s emotional and symbolic value—its meaning. If functionality aims at satisfying the operative needs of the consumer, the product’s meaning tickles her or his affective and sociocultural needs.*” Thus, Italian designers naturally have a different perspective on ‘aesthetics’ than designers from other schools of thought, especially those lacking a designer background, such as a corporate executive who thinks that design is purely styling [10].

The classical IDs that inspired this work (shown in Fig. 1) were designed by Achille and Pier Giacomo Castiglioni, brothers who pioneered the ID scene in the ‘50s and ‘60s. These designs represent a relevant development of ID, combining functionality, aesthetics, and simplicity. The Castiglioni brothers masterfully joined functionality and beauty in these three objects characterized by the principles of the Dadaist “ready-made” concept that decontextualizes common objects. They proposed the Mezzadro (Fig. 1a) and Sella (Fig. 1c) stools, which creatively combined components from different industrial sectors, realizing unique and iconic products. For instance, the Mezzadro utilizes a tractor seat, and the Sella utilizes a bicycle seat. All components were new, but instead of being employed in the product they were designated for, they were repurposed into a different product entirely. In 1962 they followed up this concept by proposing the Toio floor lamp (Fig. 1b), which encompasses a car headlamp (automotive industry), a fishing rod (sporting industry), and a transformer (electrical industry). All these products went on to become icons of ID and are still being produced to this day. Looking at these items from the lens of SM, they demonstrate opportunities to apply many of the 6Rs: common items (e.g., stool, lamp), were *redesigned* to incorporate components from various industrial sectors as materials, which enhances their long-term use and reduces efforts during manufacturing [11]. While the ID classics shown in Fig. 1 were not designed with the intent to promote SM, they do offer insights to deploy the 6Rs approach, and possibly extend their definition and meanings. For example, if the components were to be sourced from MSW (i.e., EoL items) instead, but keeping the decontextualization concept and

origin from different industrial sectors, this could enable closed-loop material flow over multiple life cycles.



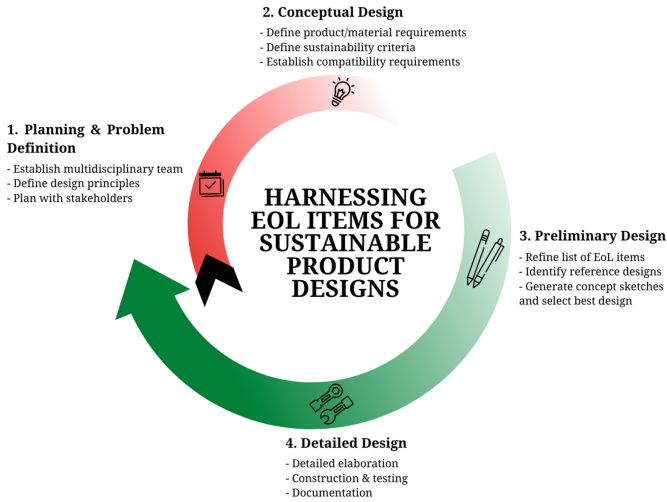
**Fig. 1.** Images of (a) Mezzadro stool [12]; (b) Toio floor lamp [13]; (c) Sella stool [14].

## 2 Methodology for Leveraging Insights from Existing Designs

### 2.1 Proposed Design Process

The aim of the present work is to bridge some ideas and concepts from ID artifacts with those from SM to synthesize new sustainable products. To illustrate the proposed design process for creating such products, the sustainable engineering design framework by Gagnon et al. [15] was adapted to align ID ideas/concepts with SM. The four stages of the product design process are described below (Fig. 2).

1. **Planning & Problem Definition:** To incorporate different perspectives, the chosen design team should be multidisciplinary, including individuals from diverse backgrounds. The design principles (6Rs, closed-loop flow, aesthetics, etc.) and TBL sustainability goals should be established early on and investigated through literature review to broaden the design team's understanding. The planning process must consider all stakeholders' interests and possible inputs.
2. **Conceptual Design:** The product/material requirements can cover the use of EoL items sourced from MSW. While some virgin materials (e.g., screws, paint, adhesives, etc.) may be required to fabricate the new products adopting the proposed approach, it is envisioned that most of the component usage for the products would consist of EoL items. Thus, the starting point is finding potential usable EoL items and compiling them into a list. The chosen items must be compatible for assembly into a final product such as those shown in Fig. 1. To meet the sustainability criteria, items should be selected based on their impact on the waste stream and accommodation for closed-loop flow.



**Fig. 2.** Framework for leveraging insights from classical IDs to create sustainable products.

3. **Preliminary Design:** The previous list of EoL items must then be filtered to include only items suitable for a new life cycle by excluding single-use, disposable components that may be contaminated and cannot be treated/cleaned. Then, examples that offer opportunities to incorporate 6R-based sustainable design practices (such as the designs shown in Fig. 1) must be identified to serve as reference. The refined list of EoL items and the reference examples can then be used to inspire novel products. The integration of insights from ID classics is especially prevalent in this stage, as the design of products based on components taken from different industrial sectors implies high artistic creativity. The best design is determined by considering sustainability impact, functionality, ease of prototype construction, aesthetics, and stakeholder input.
4. **Detailed Design:** Once a design that satisfies the required criteria is selected, minor design modifications might be necessary to ensure feasibility and functionality. After the design is finalized, the next step is to procure materials for assembling a prototype. Then it must be tested and strained to guarantee quality and safety. Finally, the project should be documented for presentation to stakeholders.

## 2.2 Application of the Proposed Design Process

The above process was applied to redesign a common household item by building a proof-of-concept prototype from EoL items across different sectors. The three ID classics shown in Fig. 1 inspired this work for their ‘out-of-the-box’ thinking. Using this idea of combining miscellaneous EoL items into a new product, the aim was to see if usable materials and components could be incorporated to form new, sustainable products that are practical, affordable, and attractive. As MSW generation has been rapidly increasing, the vision here is that reusing EoL items for new products can contribute to landfill reductions. Additionally, it is not necessary to build new manufacturing tools

to produce the components, because those components are currently available, and the manufacturing process is already established. This section discusses how each stage of the design process in Sect. 2.1 was performed to develop a sustainable prototype.

For Planning & Problem Definition, a multidisciplinary team of four members was formed. A literature review on the history of ID companies and products, as well as sustainable design practices, was conducted to establish an understanding of both disciplines. The team also studied different aspects of sustainability across the TBL.

For Conceptual Design, special attention was given to selecting items that had a major impact on the waste stream. To this aim an extensive web search was conducted to find the most common and impactful examples of MSW, and a list of 22 items was compiled. Some of the most notable (and eventually selected) identified items are:

- **Polystyrene (PS) coat hangers and polyvinyl chloride (PVC) pipes:** Coat hangers and piping are some of the most common uses for PS & PVC, respectively; 15 billion hangers are produced by the garment industry annually [16]. The  $CO_2$  emissions generated from this is equivalent to the usage of 4 billion plastic bags or the emissions from 1.5 million cars [16, 17]. Millions of tons of PS & PVC products contaminate oceans at EoL in the form of microplastics every year, ensnaring marine species, leading to morbidity and mortality [16, 18]. Less than 1% of PS & PVC was recycled in 2018 [7]. What little is recycled is granulated into chips, which destroys the embodied energy. Another EoL recovery method is incineration, which is not viable for plastics because of the emission of toxic compounds [19].
- **$2 \times 4$  wooden studs:** Nearly all residential structures in the U.S. use traditional  $2 \times 4$  wood-framing [20]. Recycling wood requires it to be ground and used for mulch or boiler fuel (again, destroying the embodied energy), so it is preferable to reuse in its whole form [20]. Diverting wood recovered from structures at EoL from landfills can significantly improve the energy and carbon balances of buildings, as landfilling creates large greenhouse gas emissions because of methane release [20, 21]. Wood recovery and reuse can also decrease deforestation because there is less need for timber harvest [21]. It is estimated that about 43–90% of solid wood waste is suitable for recovery and reuse [20, 21]. However, again signifying the importance of the design process, the recovery rate is highly dependent on whether structures are designed to facilitate the recovery of materials at EoL [22]. Only 17.1% of MSW from wood was recycled in 2018 [7].

For Preliminary Design, the list from the previous stage was filtered to remove items that were deemed unfit for a new life cycle, after which only 15 items remained. Next, the products in Fig. 1 were chosen as the reference designs for brainstorming. Using the filtered list of EoL items and the selected ID classics in tandem as inspiration, two concept sketches were produced by each member of the multidisciplinary team. The concepts were mainly furniture items, trying to imitate the examples in Fig. 1. Using feedback from stakeholders, the best design was found to be a coat rack constructed from PS coat hangers, a PVC pipe, and  $2 \times 4$  wooden studs—coat hangers come from the garment industry and the latter two are found in multiple industries like construction.

For Detailed Design, the coat rack concept sketch was modified for a more robust configuration—e.g., in the concept sketch, the coat rack originally only used the swivel

hooks from coat hangers as the hooks, but that was changed to utilize the entire hanger. The final coat rack assembly is shown in Fig. 3. It was tested and found able to support a 9 lb. load on each hook, comparable to the capacity of a similarly sized conventional coat rack of 11 lbs. Thus, the prototype is capable compared to its conventional counterpart.

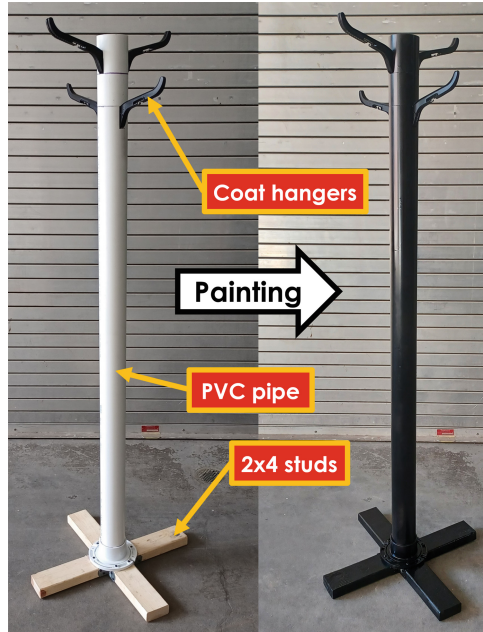


Fig. 3. Assembly of coat rack prototype.

### 3 Sustainability Impact

The sustainability performance of the coat rack could not be evaluated due to the lack of available data (quantity, condition, sizing, etc. for the items used in the product). MSW is difficult to quantify because most solid waste data is not collected regularly [23]. The limited MSW data that does exist is unreliable because it may be outdated, inaccurate, or inaccessible [24]. An assessment of the reductions achieved because of already available, reliable, and optimized manufacturing tools will also be necessary.

The authors envision a system where companies can use the residuals from EoL products to create new products, such as the coat rack prototype presented in this paper. Commercializing products such as the coat rack exemplified in this work can have many potential benefits for the TBL:

- **Economic:** Promoting the long-term use of materials/components and the use of shared manufacturing tools will contribute to decreased resource and production costs. Since companies would be symbiotically dependent, costs would be shared

amongst multiple companies [25]. There would also be decreased costs during pre-manufacturing: since MSW is being used as raw material, this lowers the need to extract resources from the environment. The novelty of the products can also increase their attractiveness, raising the economic value to customers.

- **Environmental:** The waste that would normally be considered worthless and sent to landfills is now being absorbed and incorporated into other products [25]. Therefore, the greenhouse gas emissions generated from natural resource extraction and waste disposal is mitigated. Wildlife also benefits from less waste entering ecosystems such as forests and oceans. The reduced material usage for tools and longer life for products/materials also decreases waste generation.
- **Societal:** There are emotional and symbiotic benefits for the consumer associated with products resembling ID classics. Society benefits from goods that are made for lasting and for long-term use. Furthermore, if the concept of using EoL components as a resource is normalized, then there would be a foundation for policy makers to implement regulation that furthers environmental-protection and eases economic restrictions on businesses, which allows for new jobs to be created [25]. Society also benefits from more affordable products because goods made from MSW would be cheaper to make than goods made from virgin material.

## 4 Conclusions

The conventional approaches of landfilling, incineration, or even recycling of waste are not sustainable because of their harmful effects on the environment and low retention of embodied energy. Thus, the idea of synthesizing new, sustainable products from EoL items using inspiration from ID classics was presented in this paper. A foundational framework was proposed to design novel and sustainable products leveraging ideas such as those from ID and SM. The proposed framework was applied by redesigning a coat rack to illustrate the potential products that can be manufactured. Furthermore, depending on what kinds of EoL items are incorporated into the product, there are numerous potential benefits for the TBL.

Due to time and resource constraints, a full sustainability performance assessment could not be conducted. Another topic that was not explicitly addressed is the logistics for the return, transportation, and treatment of MSW items at EoL. Incentives for the return of EoL materials will be required, and it is imperative to ensure that the materials recovered are safe for reuse and not too costly for refurbishment. The commercial viability of products such as the coat rack prototype depends on more in-depth analyses relating to the aforementioned factors. Future work could attempt to analyze these issues and assess the business case for designing novel products that generate value from waste, which would enable closed-loop SM and promote a circular economy.

## References

1. Badurdeen, F., Aydin, R., Brown, A.: A multiple lifecycle-based approach to sustainable product configuration design. *J. Clean. Prod.* **200**, 756–769 (2018)



2. Jawahir, I.S., Dillon Jr., O.W., Rouch, K.E., Joshi, K.J., Venkatachalam, A., Jaafar, I.H.: Total life-cycle considerations in product design for sustainability: A framework for comprehensive evaluation. In: Proceedings of the 10th International Research/Expert Conference, "Trends in the Development of Machinery and Associated Technology" TMT 2006, vol. 1, p. 10. Citeseer, Barcelona, Spain (2006)
3. Jawahir, I.S., Bradley, R.: Technological elements of circular economy and the principles of 6R-based closed-loop material flow in sustainable manufacturing. *Procedia CIRP* **40**, 103–108 (2016)
4. Jayal, A.D., Badurdeen, F., Dillon, O.W., Jr., Jawahir, I.S.: Sustainable manufacturing: Modeling and optimization challenges at the product, process and system levels. *CIRP J. Manuf. Sci. Technol.* **2**(3), 144–152 (2010)
5. Kreith, F., Tchobanoglous, G.: *Handbook of Solid Waste Management*. 2nd edn. McGraw Hill (2002)
6. McDougall, F.R., White, P.R., Franke, M., Hindle, P.: *Integrated Solid Waste Management: A Life Cycle Inventory*. 2nd edn. Wiley-Blackwell (2001)
7. *Advancing Sustainable Materials Management: 2018 Tables and Figures*. Environmental Protection Agency. <https://www.epa.gov> (2018)
8. Porcini, M.: What is Italian Design? (Mauro Porcini). Cottini, L., Italian Innovators, YouTube (2019)
9. Bosoni, G.: *Italian Design*. The Museum of Modern Art (2008)
10. Verganti, R.: Design as brokering of languages: Innovation strategies in Italian firms. *Design Manage. J.* **14**(3), 34–42 (2003)
11. Campana, G., Cimatti, B.: Integration of Italian design concepts for 6R-based sustainable product design. Unpublished Working Paper, University of Bologna, Italy (2022)
12. Zanotta, S.p.A.: Castiglioni Mezzadro Stool. Hive Modern. <https://hivemodern.com> (2022)
13. Decor, B.: Toio Floor Lamp. Burke Decor, <https://www.burkedecor.com> (2022)
14. Zanotta, S.p.A.: Sella. Zanotta, S.p.A., <https://www.zanotta.it>
15. Gagnon, B., Leduc, R., Savard, L.: From a conventional to a sustainable engineering design process: different shades of sustainability. *J. Eng. Des.* **23**(1), 49–74 (2012)
16. Braiform Case Study. Green Entrepreneurship Europe, <https://www.geelearning.eu> (2018)
17. García, L.F.S.: Impacts on recyclability and sustainability in hanger production by replacing polystyrene with the biocomposite DuraSense® Pure S40 Impact D. MS Thesis, Halmstad University (2020)
18. Derraik, J.G.B.: The pollution of the marine environment by plastic debris: a review. *Mar. Pollut. Bull.* **44**(9), 842–852 (2002)
19. Sadat-Shojai, M., Bakhshandeh, G.-R.: Recycling of PVC wastes. *Polym. Degrad. Stab.* **96**(4), 404–415 (2011)
20. Falk, R.H., McKeever, D.B.: Recovering wood for reuse and recycling: A United States perspective. In: European COST E31 Conference: Management of Recovered Wood Recycling Bioenergy and other Options, pp. 29–40. University Studio Press, Thessaloniki, Greece (2004)
21. Dodoo, A., Gustavsson, L., Sathre, R.: Recycling of lumber. In: Worrell, E., Reuter, M.A. (eds.) *Handbook of Recycling*, pp. 151–163. Elsevier B.V. (2014)
22. Kibert, C.J.: Deconstruction: the start of a sustainable materials strategy for the built environment. *Ind. Environ.* **26**(2), 84–88 (2003)
23. Vergara, S.E., Tchobanoglous, G.: Municipal solid waste and the environment: a global perspective. *Annu. Rev. Environ. Resour.* **37**, 277–309 (2012)
24. Wilson, D.C., Araba, A.O., Chinwah, K., Cheeseman, C.R.: Building recycling rates through the informal sector. *Waste Manage.* **29**(2), 629–635 (2009)
25. Lowe, E.A., Evans, L.K.: Industrial ecology and industrial ecosystems. *J. Clean. Prod.* **3**(1–2), 47–53 (1995)

**Open Access** This chapter is licensed under the terms of the Creative Commons Attribution 4.0 International License (<http://creativecommons.org/licenses/by/4.0/>), which permits use, sharing, adaptation, distribution and reproduction in any medium or format, as long as you give appropriate credit to the original author(s) and the source, provide a link to the Creative Commons license and indicate if changes were made.

The images or other third party material in this chapter are included in the chapter's Creative Commons license, unless indicated otherwise in a credit line to the material. If material is not included in the chapter's Creative Commons license and your intended use is not permitted by statutory regulation or exceeds the permitted use, you will need to obtain permission directly from the copyright holder.





# Literature Review of Biological Transformation in Holistic Production Systems

Annika Lange<sup>1</sup>  and Moritz Poeche<sup>1,2</sup>  

<sup>1</sup> Fraunhofer Institut Für Produktionsanlagen Und Konstruktionstechnik, Pascalstraße 8–9,  
10587 Berlin, Germany

[moritz.poeche@ipk.fraunhofer.de](mailto:moritz.poeche@ipk.fraunhofer.de)

<sup>2</sup> Technische Universität Berlin, Straße Des 17. Juni 135, 10623 Berlin, Germany

**Abstract.** In today's manufacturing world, there are large, interconnected production networks. Production is constantly influenced by trends such as the Toyota production concept or Holistic Production System. Numerous companies have already introduced a Holistic Production System. Though, to achieve the greatest success with it, the Holistic Production System must be implemented across the entire production network. This means that more and more companies are setting a condition for their suppliers: They must also implement a Holistic Production System. However, not only the introduction but also the maintenance of a Holistic Production System is associated with a high level of effort. To reduce the effort required for a Holistic Production System, Biological Transformation offers a promising approach. Especially since principles from nature are resource-saving. This paper presents a systematic literature review. This review examines the extent to which biological principles are already being used in Holistic Production Systems.

**Keywords:** Holistic Production System · Biological Transformation · Literature review

## 1 Introduction

The framework of production has changed significantly due to an ever-increasing dynamic [1]. Globalization has increased the importance of global trade in particular [2]. Companies are focusing more and more on their key developments. As a result, increasingly complex and interconnected networks are emerging. Due to globalization, worldwide production networks exist [3]. Several companies already operate a Holistic Production System (HPS) intending to achieve the highest possible output with their available resources [4]. An HPS is a company-tailored-fit set of methodical rules for extensive and universal production planning that consists of various principles [4, 5]. The reasons for introducing an HPS can be internal as well as external [6]. Nowadays, companies expect their suppliers to have an HPS as well because the potential of an HPS can only be fully developed if the entire supply chain is integrated [6]. However, maintaining an HPS requires a significant amount of time and effort.

Numerous biological principles apply to production. In nature, there are several systems and processes that conserve resources, such as photosynthesis. Therefore, principles from nature are offering a promising approach to support HPS. Transferring phenomena from biology to technology is called Biological Transformation [7, 8]. Biological Transformation is already being applied in numerous areas of manufacturing, such as product surfaces or robotic [9]. Implementation possibilities of Biological Transformation are distinguished in Bio-Inspired, Bio-Integrated, and Bio-Intelligent-Solutions, depending on the level of interaction of biosphere, technosphere, and informationsphere. The interest in Biological Transformation in manufacturing systems is growing [8]. Biological Transformation pursues two focuses. The first focus is on sustainability. The other aspect is competitiveness through the development of more efficient and robust production systems [10].

As described earlier, Biological Transformation is already being applied in numerous fields. To this end, this paper presents a systematic literature review relating to the current state of Biological Transformation in Holistic Production Systems. For this purpose, the structure of Holistic Production Systems and their principles are presented in the following section. After that, the method for systematic literature research as well as the implementation and its results are presented.

## 2 Structure and Principles of Holistic Production Systems

An HPS is an enterprise-specific model for process design [4]. Figure 1 shows the schematic structure of an HPS. In the first step, goals are set, such as increasing quality. To achieve this global goal, subgoals are derived from the main goal. Subgoals for increasing quality can be, for example, sustainable process control and product development in line with assembly requirements. The goals have an impact on the processes in the company [5]. According to FEHR ET AL., in addition to production processes, processes from marketing, research and development, planning, logistics, quality assurance, controlling, financing and human resources are also part of the HPS [11]. Function-oriented structures have numerous interfaces, consequently, there is an increased coordination effort. HPS, therefore, focuses on process orientation and design with a low number of interfaces. This results in the transparency of the processes. To achieve subgoal 1, it is necessary to consider manufacturing processes. For subgoal 2, the construction process is considered. The corresponding process principles are selected in the next step. By selecting the principles, the available methods and tools are narrowed down. A distinction is made between the principles:

- standardization,
- zero defects principle,
- flow principle,
- pull principle,
- continuous improvement process,
- employee orientation and management by objectives,
- avoidance of waste,
- visual management. [5]

The zero-defect principle contributes to the achievement of the aforementioned objectives. The methods and tools are used to achieve the goals. These are assigned to the principles depending on their orientation. For the increase in product quality and process control Poka Yoke is a suitable example of a method of the zero-defect principle [5].

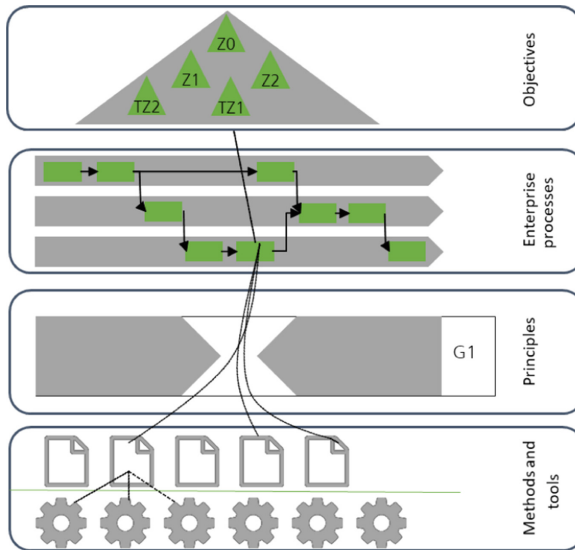


Fig. 1. Schematic structure of an HPS [5].

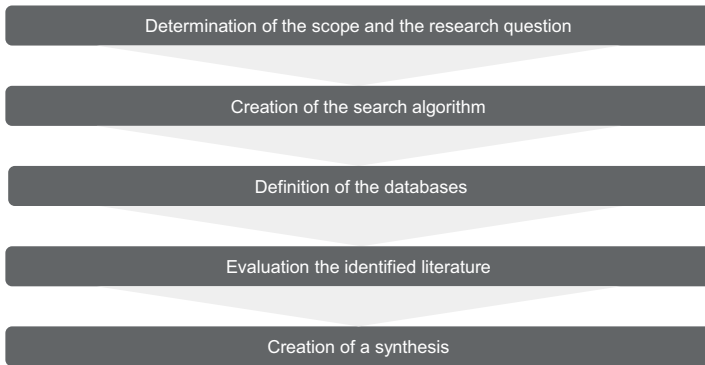
### 3 Literature Review

#### 3.1 Methodology

There are two different types of searches to identify scholarly articles on a topic. The so-called snowball search involves undirected research. This means that further papers and contributions are identified in relevant articles in the reference list [12, 13]. However, this type of search is characterized by a certain subjectivity [14]. In contrast, there is a systematic literature search, which is based on a structured and reproducible method [15]. The procedure of a systematic literature review is shown in Fig. 2, the first step is to define the research question. Based on this, the search algorithm is defined. In the third step, the databases to be searched are determined. During the search, the fourth step is to filter according to various aspects. After the search is completed, the identified literature is evaluated [14].

#### 3.2 Research Question, Search Algorithm, and Databases

As can be seen from the introduction, this paper focuses on the Biological Transformation of Holistic Production Systems. In addition to contextual containment, operational containment is also performed. To identify the relevant literature, no restrictions are made



**Fig. 2.** Procedure of a systematic literature search [14, 16].

concerning the type of literature. Contributions in English and German language are considered. The research refers to the following question. Which conceptual approaches to the Biological Transformation of Holistic Production Systems are already available?

The papers in the databases are searched according to the search algorithm, which consists of individual keywords. Based on the research question, it is obvious to use keywords such as "Biological Transformation" and "Holistic Production System" for the search. However, there are also synonyms for the term Biological Transformation, such as Biologicalisation. All terms used in the systematic literature review can be taken from Fig. 3. Fitting combinations of the terms Biological Transformation and HPS were used, aiming to locate holistic support of HPS through Biological Transformation.

Terms used for biological transformation	Terms used for holistic production systems
Biological Transformation	Holistic Production System
Biologicalisation	Lean Production System
Bionic	Production System
Biomimetic	Manufacturing System
Bio-integration	Holistic Manufacturing System
Bio-inspiration	
Bio-intelligent	

**Fig. 3.** Terms used in the systematic literature search.

Scopus is one of the largest databases of peer-reviewed articles. Unlike other databases, these two in particular cover scientific journals well. The search with the terms from Fig. 3 yielded 86 results. To further narrow the search, the next step is to filter the papers. For this purpose, two steps are executed. First, the journals and volumes in which the articles are published are reviewed for their research fields. Journals that are not related to production systems are omitted. After filtering by journals and volumes 41 papers remain. In the second step, the remaining articles are filtered. For this purpose, the

title, as well as the abstract, are included. The scope of this systematic literature search refers to the Biological Transformation of Holistic Production Systems. Neighboring research areas, such as materials or product development, were left out. After the second filtering, 10 papers remained. The following section presents these papers.

### 3.3 Evaluation of the Literature

BERGS ET AL. describe an approach for bio-inspired manufacturing. Therefore, self-adaptation in manufacturing is considered. Cyber-physical production systems (CPPS) are key technological enablers to foster flexibility of manufacturing systems towards highly individual products within a mass production regime. Ideal CPPS physical components are equipped with sensing, communicating, and computation capabilities to enable real-time manipulation of the component (digital twin), while complex computation and data processing usually are carried out by cloud services. By doing so, otherwise lifeless objects may gain biological living system characteristics. If managed and organized beneficial, e.g. holistically like nature, CPPS are expected to deliver high capabilities of self-adaptation, including self-diagnosis, self-configuration, and self-optimization. Based on the digital twin properties it is possible to digitally process all component-specific information, containing all planning, raw material, and machining data covering the entire lifecycle. This means CPPS facilitate the bio-integration of production systems [17].

BAUER ET AL. develop a generic model to describe and characterize the essential developmental stages of autonomous production. Autonomous production compiles self-organization, self-optimization, dynamic and distributed networking, flexibility, adaptability, and virtualization. Due to automation progress, cyber-physical systems emerged which are linked directly to the feasibility of autonomous processes. Digital transformation is seen as the evolutionary development of industrial manufacturing towards connected and autonomous cyber-physical production systems. Lastly, Biological Transformation is described as addressing the comprehensive set of challenges for future manufacturing systems based on resource dependency, energy efficiency, and system complexity which cannot be solved by digital transformation alone. This clarifies that, for real, sustainable, and beneficial future autonomous production, biological principles, such as swarm-intelligence and metabolism principles, have to be integrated into manufacturing. The stage model is presented in a morphological box and consists of different features of manufacturing systems – depending on its scope – with each owning five different maturity levels as possible solutions. The defined autonomous production systems are as follows:

- stage 0: analog factory,
- stage 1: transparent factory,
- stage 2: flexible factory,
- stage 3: semi-autonomous factory and
- stage 4: autonomous factory.

The features of each stage are presented by the author. Lastly, the model was evaluated by experts who had to assess their actual and targeted stages [18].

LEITAO AND BARBOSA also consider autonomous factories. They describe how the inspiration of animal swarms helps to get an autonomous factory. Thereby they consider for example supply chains, shop floor layout and scheduling [19].

MELLA ET AL. describe the holonic view applied to manufacturing systems. The holonic view is a concept of realizing everything in the universe, may it be atoms, molecules, cells, individuals, systems, words or concepts must not be seen as an individual but as a whole composed of smaller parts while being part of a larger whole. Holarchies and holonic networks based in the manufacturing industry are the Holonic Manufacturing System, the Bionic Manufacturing System, and the Fractal Manufacturing System. In Holonic Manufacturing Systems (HMS) holons are seen as building blocks of a manufacturing system with the capabilities of autonomy and cooperation, therefore creating operational plans and strategies and controlling their implementation, carrying out processes involving transformation, transportation, conservation, and control of physical objects or information. HMS's special trait is that it involves simple units (holons) and methods of cooperation to perform complex tasks. If a holon has a problem or fails to execute the task then other holons reroute the process to avoid major disruptions. The Bionic Manufacturing System (BMS) holarchy is seen as a similar approach to the HMS. Its design methodology is conceived as an interaction of elementary cooperative, flexible, and adaptive individual operator holons. The differentiating feature of a BMS is the capability of autonomous decision-making of not only the processes to carry out but also the necessary input and output volumes, by each operational unit [20].

Several authors, such as REISS ET AL. [21], RAIS ET AL. [22], and THARUMARAJAH ET AL. [23], also consider holonic production systems.

DEMEESTER ET AL. describe an organic production system that is based on a biological cell. A cell uses a small set of inputs to manufacture a wide range of compounds that help to interact appropriately with its environment and eventually allow it to reproduce itself. Just as in production systems the cell metabolism can be depicted in a flow diagram where raw materials are transformed into products by a series of processes. Enzymes in a cell are considered machines within a production system. With its thousands of biochemical reactions and flow connections, the cell's complexity of production matches even the most complex industrial manufacturing networks. While the basic functions are comparable its performance pressures are similar as well. The cell uses many mechanisms applied to today's production systems. As an example, a cell operates in a very lean way by using pull systems, and excess capacity is kept to a minimum. Broken molecules do not leave the source in the cell, therefore ensuring quality control and avoiding rework loops. Lastly, the cell uses modularity, component commonality, and postponement in its biochemical pathways (production lines) for its advantage. The equivalent to the pull system in manufacturing is the feedback inhibition in cells. Production in cells only occurs if the final product is depleted, coined downstream shortage. Furthermore, the cell uses a key-lock principle to guarantee a proper fit between substrate and enzyme, so that only a particular substrate can be further processed by an enzyme. This technique is comparable to the Poka Yoke technique. In conclusion, an organic production system consists of customized local production with universal components and just-in-time tools as well as a local circular economy [24].



## 4 Conclusion and Outlook

Today's challenges in manufacturing, Holistic Production Systems, and Biological Transformation are introduced. The focus of this paper is HPS, therefore the structure according to VDI 2870 is described. The main part contains a literature review. For this purpose, the approach as well as the results are shown. The approaches identified relate generally to production. However, in the paper by DEMEESTER ET AL. Poka Yoke is included as a GPS principle. The literature review shows that Biological Transformation is already part of production systems. However, Holistic Production Systems are not yet fully considered. In the next step, biological principles which support HPS have to be identified and integrated.

## References

1. Lescher, M., 2008. Automatisierte Generierung von Arbeitsabläufen für den Service an Produktionssystemen. Zugl.: Aachen, Techn. Hochsch., Diss., 2008. Shaker, Aachen
2. Wu, J.: An analysis of business challenges faced by foreign multinationals operating the Chinese market. *Int. J. Bus. Manage.* **3**(12), 169–174 (2008)
3. Colicchia, C., Dallari, F., Melacini, M.: Increasing supply chain resilience in a global sourcing context. *Prod. Plan. Control* **21**(7), 680–694 (2010)
4. Dombrowski, U., Mielke, T.: *Ganzheitliche Produktionssysteme*. 340 p. Springer, Berlin (2015). <https://doi.org/10.1007/978-3-662-46164-8>
5. VDI 2870, 2012. *Ganzheitliche Produktionssysteme: Grundlagen, Einführung und Bewertung*
6. Dombrowski, U., Schmidtchen, K.: Ganzheitliche Produktionssysteme: KMU-spezifische Konzeption und Implementierung. *Zeitschrift für wirtschaftlichen Fabrikbetrieb* **105**(10), 914–918 (2010)
7. Bauernhasl, T., Brecher, C., Drossel, W.-G., Gumbsch, P., ten Hompel, M., Wolperdinger, M.: *Biointelligenz: Eine neue Perspektive für nachhaltige industrielle Wertschöpfung* (2019)
8. Byrne, G., et al.: Towards high performance living manufacturing systems - a new convergence between biology and engineering. *CIRP J. Manuf. Sci. Technol.* **34**, 6–21 (2021)
9. VDI 6220, *Bionik: Grundlagen, Konzeption und Strategie*, 16 p. (2019)
10. Monostori, L., Vánca, J.: Towards living manufacturing systems. *Procedia CIRP* **93**, 323–328 (2020)
11. Fehr, S., Sauber, K., Schmidt, T.: Klassifizierung der Methoden eines Ganzheitlichen Produktionssystems unter Berücksichtigung der Anforderungen indirekter Bereiche. *Logist. J. Proc.* **2012**, 1–8 (2012). <https://www.logistics-journal.de/proceedings/2012/3463>
12. Duff, A.: The literature search: a library based model for information skills instruction. *Libr. Rev.* **45**(4), 14–18 (1996)
13. Töpfer, A.: *Erfolgreich Forschen*. Springer, Berlin, 451 p. (2012)
14. Fink, A.: *Conducting research literature reviews: From the internet to paper*, 4th ed. SAGE, Los Angeles, London, New Delhi, Singapore, Washington DC, 257 p. (2014)
15. Denyer, D., Tranfield, D.: Producing a systematic review. In: Buchanan, D.A., Bryman, A. (eds.) *The Sage Handbook of Organizational Research Methods*, pp. 671–689. Sage Publications Inc, Thousand Oaks (2011)
16. Stockmann, C.: *Untersuchung der Robustheit in Produktionssystemen. Konzeptionelles Verständnis, Bewertungsmethode und Managementansatz*. Logos Verlag, Berlin 2021
17. Bergs, T., et al.: Application cases of biological transformation in manufacturing technology. *CIRP J. Manuf. Sci. Technol.* **31**, 68–77 (2020)

18. Bauer, D., Schumacher, S., Gust, A., Seidelmann, J., Bauernhansl, T.: Characterization of autonomous production by a stage model. *Procedia CIRP* **81**, 192–197 (2019)
19. Leitão, P., Barbosa, J.: Biological inspiration to solve complexity in intelligent and adaptive manufacturing systems. *IFAC Proc.* **10**(1), 204–209 (2010)
20. Mella, P., Gazzola, P.: The holonic view of organizations and firms. *Syst. Res* **34**(3), 354–374 (2017)
21. Reiss, M., Ehrenmann, F.: Holonic, Bionic und Fractal Manufacturing der nächsten Generation: Empiriebasierte Weiterentwicklung von Mainstream-Produktionskonzepten. *Zeitschrift für wirtschaftlichen Fabrikbetrieb* **106**(12), 949–954 (2011)
22. Rais, S., Szigumura, N., Kokubun, A.: Study on process planning system for holonic manufacturing. *JSME Int. J.* **45**(2), 527–533 (2002)
23. Tharumarajah, A., Wells, A.J., Nemes, L.: Comparison of emerging manufacturing concepts, In: *SMC'98 Conference Proceedings. 1998 IEEE International Conference on Systems, Man, and Cybernetics (Cat. No. 98CH36218). SMC '98 Conference Proceedings. 1998 IEEE International Conference on Systems, Man, and Cybernetics, San Diego, CA, USA. 11–14 October 1998. IEEE*, pp. 325–331 (1998)
24. Demeester, L., Eichler, K., Loch, C.H.: Organic production systems: what the biological cell can teach us about manufacturing. *M&SOM* **6**(2), 115–132 (2004)

**Open Access** This chapter is licensed under the terms of the Creative Commons Attribution 4.0 International License (<http://creativecommons.org/licenses/by/4.0/>), which permits use, sharing, adaptation, distribution and reproduction in any medium or format, as long as you give appropriate credit to the original author(s) and the source, provide a link to the Creative Commons license and indicate if changes were made.

The images or other third party material in this chapter are included in the chapter's Creative Commons license, unless indicated otherwise in a credit line to the material. If material is not included in the chapter's Creative Commons license and your intended use is not permitted by statutory regulation or exceeds the permitted use, you will need to obtain permission directly from the copyright holder.





# Evaluating the Sustainability of Paper and Plastic Substitute Material LimeX

E.-Lexus Thornton<sup>1,2</sup>(✉), Avery Hartley<sup>1,2</sup>, Daniel Caudill<sup>1,2</sup>, Martin Gamesu<sup>1,2</sup>, Julius Schoop<sup>1,2</sup>, and Fazleena Badurdeen<sup>1,2</sup>

<sup>1</sup> Institute for Sustainable Manufacturing, University of Kentucky, Lexington, KY 40506, USA  
eth231@uky.edu

<sup>2</sup> Department of Mechanical Engineering, University of Kentucky, Lexington, KY 40506, USA

**Abstract.** With the increasing decline in the environment and natural resources it is important to find new ways in which manufacturing can increase the sustainability of the world. This study seeks to compare LimeX, a state-of-the-art paper and plastic alternative primarily made of limestone, with conventional paper and plastic materials. For a better understanding of LimeX as a material, a brief investigation of the mechanical and chemical properties will be performed through experimentation and analysis. In addition, this paper aims to evaluate the sustainability of LimeX through the analysis of metrics relating to the triple bottom line (environmental impacts, economic impacts and societal impacts) to evaluate and compare the sustainability performance of LimeX products with conventional paper and plastic products. The previously developed Product Sustainability Index (ProdSI) will be adapted and used in this study to conduct the sustainability evaluation. Major findings will include results from an experimental analysis of LimeX via SEM and EDS, and LimeX material property measurements via tensile testing and density measurements. In addition, there will also be a comparison of the sustainability performance of conventional paper and LimeX using a simplified ProdSI. The study found that LimeX was marginally more sustainable than paper, but this evaluation could change with information from the development of a life-cycle analysis report on the material.

**Keywords:** LimeX · Product sustainability index · Paper and plastic alternative

## 1 Introduction

There has long been a focus on the development of an alternative for conventional paper and plastic to improve global sustainability [1]. The manufacturing of synthetic oil-based plastics such as polypropylene (PP), polyethylene (PE) and polystyrene (PS) has led to an insurmountable amount of waste and CO<sub>2</sub> emissions accumulating. This study aims to introduce and investigate a recently developed paper/plastic alternative called LimeX, a material primarily made from limestone (CaCO<sub>3</sub>) with a plastic additive added to act as a binder for the material, to determine its sustainable performance in comparison to that of conventional paper and plastic. In recent research [2–5], the Product Sustainability

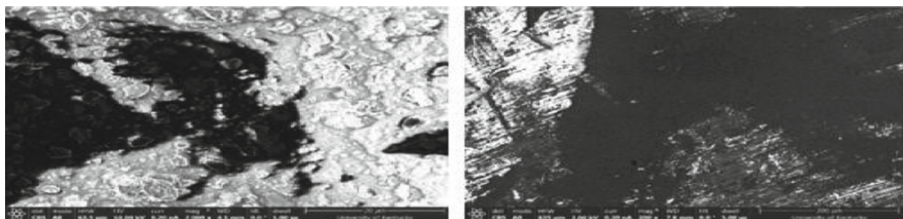
Index (ProdSI) has been instrumental in successfully evaluating and improving the sustainability of products. The ProdSI centers around three basic parameters of economic prosperity, environmental protection and societal well-being which are referred to as the triple bottom line (TBL) [3]. Fiksel et al. determined a list of product sustainability indicators to assess the TBL aspects of products [6]. Then a new and improved framework for the evaluation of product design for sustainability was presented by Jawahir et al. [7]. Although subjective, sustainability evaluations taking the lifecycle of a product into account could lead to a more effective evaluation of the total lifecycle sustainability performance [7]. Finally, Shuaib et al., [8] used the metrics from [7], together with new metrics for TBL criteria, to develop the ProdSI and applied it to compare the sustainability performance of two different generations of consumer electronics products [7]. The metrics highlighted in [7, 8] include waste, extraction, emissions, material recovery and efficiency and recyclability in terms of the environmental impacts; material, production, injury, warranty, labor and raw material costs in terms of economics; and ergonomics, ethics, functionality, safety and health in terms of societal impacts. In this study, similar metrics are highlighted to evaluate the sustainable performance of LimeX products.

## 2 Experimental Analysis of LimeX

A series of experiments were performed to investigate the information provided by the company that manufactures LimeX, TBM [9]. Part of the investigation into LimeX involved confirming that its composition was primarily limestone, as indicated by the manufacturer. In addition, an evaluation of the strength of LimeX paper was conducted to determine whether it was more durable than conventional paper. The measurements obtained from the analysis were used to inform the ProdSI-based sustainability analysis. The mechanical properties of the products play a role in how the product functions and the feasibility of multi-life-cycle applications of LimeX.

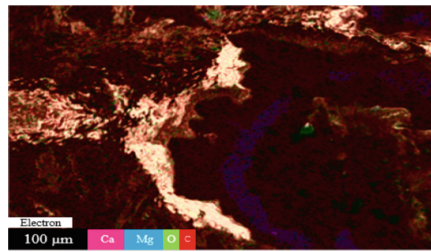
### 2.1 Scanning Electron Microscopy and Energy-Dispersive X-ray Spectroscopy Analysis of LimeX Pellets

Initial electron microscopy characterization of the LimeX surface topography was performed with a FEI Helios NanoLab 660 microscope. Subsequently, the first few micrographs were used to determine if the LimeX pellets were porous.



**Fig. 1.** Electron Microscopy Micrographs of LimeX Pellet.

Because of the non-conductive nature of the LimeX, there were difficulties in imaging caused by the charging of electrons on the surface. However, this charging led to some insights in the composition of LimeX. Charging, instead of random placement, appeared to be localized in specific areas of the sample seen in Fig. 1. This was likely due to inhomogeneity in composition. Additionally, the charging of electrons made it difficult to capture extremely magnified images as the charging increases as the beam is localized. A lower voltage along with a circular backscatter detector was utilized in combating charging. After initial analysis, the pellets were imbedded into a conductive, graphite puck to prevent charging issues by giving the electrons a path to disperse more quickly. Grinding away the surface and making a planar sample also reveals that the interior surface of the pellet is not porous. Moreover, EDS results (presented in Fig. 3) show anisotropy of chemical composition suggesting LimeX is non-homogeneous.



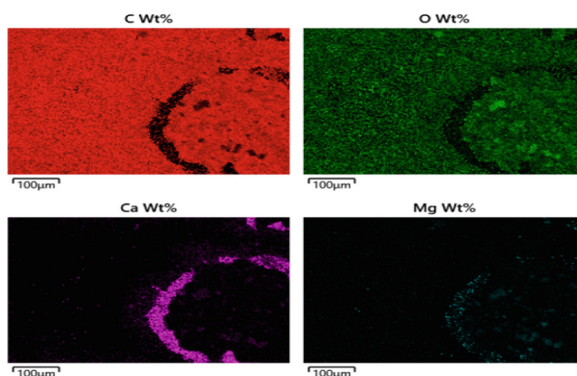
**Fig. 2.** Electron Microscopy Micrograph used for EDS.

The voltage was increased from the previous 2kV to 10 kV to allow for better penetration of electrons and more surface detail when capturing images of the pellets inside the graphite puck. The compositional maps in Fig. 2 show that the material is in-homogeneous with very little calcium being present on the surface compared to the amount of carbon and oxygen present on the surface. What's more, the magnesium present suggests the mined limestone contained dolomite ( $\text{CaMg}(\text{CO}_3)_2$ ) and not just the typical calcite ( $\text{CaCO}_3$ ) found in limestone. The complete chemical composition can be seen in Table 1 below. Conventional paper is primarily made of cellulose.

**Table 1.** Chemical composition of LimeX pellets.

Element	Weight %	Signal
C	72.28	0.11
O	24.14	0.10
Ca	2.64	0.04
Mg	0.65	0.2
Si	0.18	0.2
Al	0.11	0.2

Furthermore, there is a small portion of silica and aluminum found in the LimeX pellet. These are thought to be imbedded during the polishing process.



**Fig. 3.** EDS Micrographs showing anisotropy of LimeX's chemical composition.

## 2.2 Material Property Testing

A 5 kN Instron Tensile Testing machine and Bluehill Software were utilized to conduct semi-destructive tensile tests that measured the strength and Young's modulus of four LimeX paper samples with differing thicknesses of 150, 200, 300, and 400  $\mu\text{m}$ . An extension rate of 7.5 mm/min was applied. The experiment was repeated three times per thickness. Table 2 shows the material properties found for LimeX paper. The experimental tensile strength values match the values provided by TBM, but the experimental values of Young's modulus differ from the values provided by approximately 20% [9]. This error may be ascribed to a difference in the material properties due to changes made by manufacturing processes. To conclude, the strength and toughness values indicate that LimeX paper is stronger and more durable than conventional paper when comparing the tensile strength test to a bursting test [10]. However, conventional paper is anisotropic and dependent on fiber direction leading to a measurement of tensile strength in units per length rather than area.

## 3 LimeX Sustainability Evaluation

Product sustainability evaluations for product design as researched by Shuaib et al. and Jawahir et al. [3, 8], and additively manufactured products as researched by Zhang et al. and Happuwatte et al. [4, 11] have been developed and have been used to make substantial progress in the assessment of product sustainability. While product sustainability evaluations provide benefits through a rigorous sustainability analysis framework, they are also very subjective due to the weighing and normalizing of individual metrics [11]. The subjectivity involved in sustainability evaluations can lead to different results depending on the biases. Although this is the case, product sustainability assessment methods

**Table 2.** Experimental tensile test results for LimeX paper.

Thickness ( $\mu\text{m}$ )	LimeX - Average Tensile Strength (MPa)	Average Young's Modulus (MPa)	Average Max. Load (N)
150	13.46	1949.05	13.82
200	14.38	2181.57	18.70
300	14.1	2,117.71	27.49
400	14.31	2,029.93	37.21
St. Dev	0.42	101.58	10.30

have been shown to accurately reflect changes in sustainability performance for different generations of products as shown by [3]. For context, there is a five-level hierarchical structure in the construction of a ProdSI [5]. The five levels, top to bottom, include: ProdSI, sub-indices, clusters, sub-clusters, and individual metrics. The sub-indices represent key performance areas relevant to each TBL aspect. The clusters are divided into sub-clusters that address elements relating to the clusters they fall under [5]. Finally, the sub-clusters are divided into individual, measurable metrics [5]. The measured values are then converted into dimensionless scores. Afterwards the dimensionless scores generated are aggregated to determine the ProdSI score. Once the ProdSI score is obtained, the entire process is reviewed for errors and the sustainability performance is determined. Because this paper focused on the introduction of a new paper/plastics product, performing a product sustainability evaluation is a necessary step in investigating its sustainability performance. Due to the lack of access to data for all different metrics, this paper utilized a simplified ProdSI to investigate the performance of LimeX products.

### 3.1 Selection of Individual Metrics

Firstly, the individual metrics chosen in this study for sustainability evaluation were determined based on elements related to the manufacturing of paper and plastic products. The ProdSI application was simplified (not concentrating on clusters and sub-cluster) to only identify metrics that will provide a general framework to measure performance of the two products under review towards achieving sustainability goals. To start, the key metrics in determining environmental sustainability were identified as energy use, waste generated, and resource efficiency. Next, the economic impacts sub-index is assessed based primarily on the initial investments, costs, benefits and losses. Finally, the societal impacts sub-index was assessed by primarily focusing on safety and health impacts, functional performance, product end-of-life (EOL) management, and product impact. These individual metrics were chosen based on each focus and had to be a quantifiable value with a unit or have shown a clear advantage/disadvantage in terms of sustainability.

### 3.2 Weighing and Aggregation

Weights are assigned to metric based on the equal weight method, given by [5]. However, not every individual cluster and sub-cluster has a quantifiable unit due to the lack of information on LimeX, and so a simplified approach was taken in which positive and negative values were assigned based on the information obtained for each individual metric. [11]. For example, if the development of LimeX plastic is safer than the development of conventional plastic (no quantifiable measurement), the score for the LimeX plastic safety metric would be slightly higher than the conventional plastic safety metric based on the conclusions of the study taken. The quantifiable measurements can be scored directly based on the measured values and what's being measured. This is explained in depth in the next section.

$$ProdSI = \frac{1}{3}(E_c + E_v + S_c) \quad (1)$$

$$E_c + E_v + E_c = \frac{1}{3} \sum_{i=1}^3 w_i C_i + \frac{1}{3} \sum_{i=4}^7 w_i C_i + \frac{1}{3} \sum_{i=8}^{10} w_i C_i \quad (2)$$

Here,  $E_c$ ,  $E_v$ ,  $S_c$ ,  $w_i$ , and  $C_j$  are the sub-index score for economic impact, sub-index score for environmental impact, sub-index score for societal impact, weight of the  $i^{\text{th}}$  metric and score of  $j^{\text{th}}$  metric, respectively.

## 4 Sustainability Results and Discussion

As stated in the introduction, the aim of this paper was to investigate LimeX products and calculate a ProdSI to evaluate its sustainability. The ProdSI will be simplified due to the lack of life cycle data available for the material. The individual metrics generated by the ProdSI will be utilized to quantitatively evaluate and compare its environmental, societal, and economic impacts with that of conventional paper and plastic. This section will include a breakdown of each metric, sub-index and ProdSI score. The physical quantification of individual metrics cannot be grouped together directly, therefore the metrics must be converted into a single normalized scale [3]. In this study, rather than normalizing measured values for the individual metrics [3], a score from 0–10 where 0, 2, 4, 6, 8, and 10 are the worst case, bad, below average, average good, and best respectively was utilized to place the individual metrics on a dimensionless scale. The scores are based on subjective factors specifically pertaining to the importance of each metric in terms of each sub-index. A standard normalization method for the conversion does not exist [12]. In this context, the score of each metric was determined based on the value of each measurement, based on the advantage and/or disadvantage of each measured value pertaining to the overall sustainability, and how relevant the metric is to the sustainability performance. The individual metrics were weighed equally for simplicity. Equation 1 and 2 were used to compute the sub-index and ProdSI scores (Table 3 and 4).



**Table 3.** ProdSI Metrics selected for analysis.

Sub-Index	Metric 1	Metric 2	Metric 3	Metric 4
Env	Energy use	Waste Generation	Material Use	
Econ	Costs	Benefits/Losses	Investments	
Soc	Safety/Health	Function	Production EOL	Product Impact

**Table 4.** ProdSI Computation.

Sub-Index	LimeX Metric Score	Paper Metric Score	LimeX SubIndex Score	Paper Sub-Index LimeX ProdSI Score Score	Paper ProdSI Score
Env	7,6,7	4.5,4,5	6.67	4.5	
Econ	6,5,6	5,7,8	5.67	6.67 6.78	6.22
Soc	7,6,7,4	6.5,6,3,7	8	7.5	

**4.1 Environmental Impacts**

The energy consumption for LimeX is less than that of paper because LimeX products use more renewable resources and less non-renewable resources than conventional paper and plastic [13]. Secondly, the waste generation metric in the environmental section of the ProdSI was given a score of 6 and 4 because LimeX products emit less CO<sub>2</sub> than conventional paper and plastic [14]. Lastly, there is the material use metric. The score given for material use was a 7 and 5 because to date, a higher percentage of LimeX products are recycled than conventional paper and plastics [14].

**4.2 Economic Impacts**

The cost metric in the economic impacts section of the ProdSI was given a score of 6 and 5 because the cost of conventional paper was more than the cost of LimeX products and because there are fluctuations in the cost of the oil-based resin used in conventional plastic where this is not the case for LimeX products. Additionally, the benefits/losses metric in the economic impacts section of the ProdSI was given a score of 5 and 7 because there are already many recycling facilities for conventional paper and plastic in the US, but there are no recycling facilities for LimeX products. Although LimeX does not use trees in its lifecycle and uses very little water, it does require the mining of limestone. Finally, the initial investment metric in the economic impacts section of the ProdSI was given a score of 6 and 8 because very little investments are required for conventional paper/plastics products that are already the norm whereas there is no infrastructure for LimeX.

### 4.3 Societal Impacts

In the final sub-index section, safety and health metric in the societal impacts section of the ProdSI was given a score of 7 and 6.5 because the operator safety/health for LimeX products was reported to be higher and better than for conventional paper. Afterwards, the functional performance metric in the societal impacts section of the ProdSI was given a score of 6 and 6 because LimeX is stronger than conventional paper. Lastly, the product EOL management metric in the societal impacts section of the ProdSI was given a score of 7 and 3 because LimeX products are much more recyclable than conventional paper and plastics. Ultimately, the product social impact metric in the product societal impacts section was given a score of 4 and 7 because LimeX products are not visible globally, being relatively new.

## 5 Conclusion

The ProdSI method adapted from previous methods in this paper compares the paper and plastic substitute material LimeX to currently used conventional paper/plastic products. Results from the simplified ProdSI indicate the sustainability performance of LimeX, producing a ProdSI of 6.78, was better than conventional paper and plastics, with a ProdSI of 6.22. However, since LimeX products are relatively new there has been little to no evidence of a LimeX lifecycle and discarding of LimeX products in the US. Results from the experimental analysis in Sect. 2 indicate that LimeX paper is stronger than conventional paper and that the material is primarily limestone as claimed by TBM [9]. Further research is required to validate long-term sustainability of LimeX. In future work, a life-cycle analysis of LimeX will be conducted in the US.

## References

1. Song, J., et al.: Biodegradable and compostable alternatives to conventional plastics. *Philos. Trans. R. Soc. B: Biol. Sci.* **364**(1526), 2127–2139 (2009)
2. Huang, A., Badurdeen, F.: Sustainable manufacturing performance evaluation: Integrating product and process metrics for systems level assessment. *Procedia Manuf.* **8**, 563–570 (2017)
3. Shuaib, M., et al.: Product sustainability index (ProdSI) a metrics-based framework to evaluate the total life cycle sustainability of manufactured products. *J. Ind. Ecol.* **18**(4), 491–507 (2014)
4. Zhang, X. et al.: A metrics-based methodology for establishing product sustainability index (ProdSI) for manufactured products. In: Dornfeld, D., Linke, B. (eds) *Leveraging Technology for a Sustainable World*, p. 435-441. Springer, Berlin (2012). [https://doi.org/10.1007/978-3-642-29069-5\\_74](https://doi.org/10.1007/978-3-642-29069-5_74)
5. Zhang, X., et al.: On improving the product sustainability of metallic automotive components by using the total life-cycle approach and the 6R methodology (2013). <https://doi.org/10.14279/depositonce-3753>
6. Fiksel, J., McDaniel, J., Spitzley, D.: Measuring product sustainability. *J. Sustain. Prod. Des.* 7–18 (1998)
7. Shuaib, M., et al.: 15.6 Sustainability evaluation using a metrics-based Product Sustainability Index (ProdSI) methodology—a case study of a consumer electronics product

8. Jawahir, I., et al.: Total life-cycle considerations in product design for sustainability: a framework for comprehensive evaluation. In: Proceedings of the 10th International Research/Expert Conference, Barcelona, Spain, Citeseer (2006)
9. TBM
10. Paper Properties. Paperonweb. Properties of Paper 7 Dec 2022. <https://www.paperonweb.com/paperpro.htm>
11. Hapuwatte, B., et al.: Total life cycle sustainability analysis of additively manufactured products. *Procedia CIRP* **48**, 376–381 (2016)
12. Böhringer, C., Jochem, P.E.: Measuring the immeasurable—a survey of sustainability indices. *Ecol. Econ.* **63**(1), 1–8 (2007)
13. Narita, N., Sagisaka, M., Inaba, A.: Life cycle inventory analysis of CO<sub>2</sub> emissions manufacturing commodity plastics in Japan. *Int. J. Life Cycle Assess.* **7**(5), 277–282 (2002)
14. Chasan, E.E.G.B.: There’s Finally a Way to Recycle the Plastic in Shampoo and Yogurt Packaging P&G’s technology solves polypropylene’s smell problem (2019)




**Open Access** This chapter is licensed under the terms of the Creative Commons Attribution 4.0 International License (<http://creativecommons.org/licenses/by/4.0/>), which permits use, sharing, adaptation, distribution and reproduction in any medium or format, as long as you give appropriate credit to the original author(s) and the source, provide a link to the Creative Commons license and indicate if changes were made.

The images or other third party material in this chapter are included in the chapter’s Creative Commons license, unless indicated otherwise in a credit line to the material. If material is not included in the chapter’s Creative Commons license and your intended use is not permitted by statutory regulation or exceeds the permitted use, you will need to obtain permission directly from the copyright holder.





# Requirements for the Development of a Performance Management System with Consideration of Unforeseeable Business Process Variants

Yu-Min Teng<sup>1,2</sup> , Sila Ay<sup>1,2</sup> , Rishabh Iyer<sup>1,2</sup> , and Julia-Anne Scholz<sup>2</sup> 

<sup>1</sup> Technische Universität Berlin, Straße Des 17. Juni 135, 10623 Berlin, Germany  
y.teng@campus.tu-berlin.de

<sup>2</sup> Fraunhofer Institute for Production Systems and Design Technology IPK, Pascalstraße 8-9,  
10587 Berlin, Germany

**Abstract.** Supply chain issues arising from market turbulences force companies to find new solutions in the short term. Hence, deviations from the ideally designed business processes are inevitable, especially during production planning and control. These deviations result in unforeseen process variants. In addition, process steps of those process variants are often not completely conducted with IT systems and are therefore difficult to trace. Another underlying problem lies in the bias of performance measurement of process variants because each variant aligns with different goals and framework conditions. For these and other reasons, the performance management of process variants presents a challenge. To overcome this challenge, a serious game is being further developed in a research project. The goal is to provide trainings for performance management in a turbulent business environment with the serious game. It simulates the business processes and supply chain issues of a drilling machine manufacturer and serves as a use case for the research presented in this paper. The challenges associated with the performance management of unforeseeable business process variants are derived from the use case. A gap analysis is conducted between the challenges and existing requirements for the development of performance management systems. Based on this, adjustments are proposed to existing requirements and new requirements are being developed.

**Keywords:** Performance Management System (PMS) · Supply Chain Issues · Business Process Variants · Serious Game

## 1 Introduction

In science, process variants are defined as “A subset of executions of a business process that can be distinguished from others based on a given predicate” [1]. In other words: “A business process variant is a fundamental flow variant of a business process which uses the same input and delivers the same measurable outcome” [2]. In manufacturing companies, there are three main factors for the different executions and deviations from

the ideally designed business process: deliberate business decisions, human factors, and contextual factors [1]. In terms of deliberate business decisions such as changes in the corporate strategy and the product portfolio, the process variant emerges due to plannable changes in the company [1]. Especially SMEs in a highly competitive business environment need to create diverse product variants in order to meet customer demands, which leads to a large amount of customer-specific production processes [3]. In terms of human factors, limited knowledge, time, or, resources as well as unintended mistakes can lead to process variants [1]. Another type of process variant emerges as a result of contextual factors from the corporate environment [1]. These variants can be further categorized as exception handling and ad-hoc problem solving [4, 5]. The former, exception handling, concerns the management of rare, large-scale disruptions, that have an impact on the company as a whole. Recent examples of such disruptions are COVID-19 pandemic and natural disasters. This work deals with the latter, ad-hoc problem solving: The type of process variants that arise due to unforeseeable, ad-hoc problems such as supply chain issues arising from market turbulences. Those problems force companies to find new solutions in the short term and primarily interrupts the production planning and control processes [6].

Managing large, globalized enterprises increases the need for Performance Management Systems (PMS) as unforeseen problems occur at production sites with greater speed and complexity [7]. A PMS is a system that generates performance information through strategic planning and performance measurement routines and that connects this information to decision venues [8]. KRAUSE [9] conducted an empirical study on existing PMS approaches in practice. From the study, he derived requirements and developed a stakeholder benefit-oriented and business process-based method to successfully develop and implement PMS. However, in the method, deviations from the ideally designed processes are not considered. In fact, many organizations suffer from simultaneously managing a large number of process variants, resulting in high resource consumption [2]. To overcome this challenge, requirements for the development of a PMS with consideration of process variants for ad-hoc problem solving are being developed on a use case basis and are presented in this paper.

This research is conducted by TU Berlin students within the framework of a research project, which is funded by the German Federal Ministry of Education and Research (BMBF) and led by the Fraunhofer IPK. In Sect. 2, the use case is described in detail. Section 3 contains an overview of the challenges associated with process variants. These challenges were derived from the use case. Section 3 also gives an overview of the state of the art of PMS. Section 4 elaborates on the degree of how much the requirements by KRAUSE [9] address the named challenges and proposes adjustments as well as an additional requirement. Section 5 provides a summary and outlook.

## 2 Use Case

The challenges associated with the performance management of process variants are analyzed based on a serious game, in which the non-linear production processes as well as the supply chain problems of a drilling machine manufacturer are simulated as a use case. A serious game is an experimental learning approach without exposure to risks and

dangers, and have proven to provide researchers the chance to research complex, poorly organized problems and prepare stakeholders for practical decisions [10]. The products of the drilling machine manufacturer range from hand-held cordless drill drivers and universal rotary hammer drilling machines to jigsaws. To meet regional requirements and customer preferences in the use case scenario, each product is available in various product variants.

The target for this research is a driller production line operated by a pull-principle with the capability of sequentially producing seven product variants. All essential business processes such as sales, production, assembly as well as logistics are established. Contemporary challenges such as short-term order fluctuations are reflected. In the course of the serious game, a sudden supply chain issue occurs: Due to local regulations, a particular part of the drilling machine is banned from production after the discovery of hazardous chemical material linked to a health issue. Concerning this issue, three product variants can no longer be sold. To address the issue, the company has the following options shown in Table 1.

**Table 1.** Options in the serious game for solving a sudden supply chain issue.

		Impact Categories			
		Cost/ Budget	Revenue	Customer	Legal
Options	A - New Supplier	<i>Higher part cost</i>			
	B - Invest in new equipment	<i>Higher investment</i>			
	C - Eliminate affected product		<i>Loss of roughly 60% of revenue</i>	<i>Risk of losing customers (portfolio issue)</i>	
	D - Ignore regulations			<i>Risk of losing customers (health issue)</i>	<i>Penalty of 30-60% of profit</i>

In order to compare the solution options and resulting process variants, it is not enough to directly compare the impact of one option to the other because the process performance is a result of a series of intertwined decisions that are made before and after the incident [11]. For example, the company would weigh up options A and B according to the make-or-buy strategy. If the same part is delivered by a new supplier, efforts are necessary to integrate the new supplier, but the manufacturing processes could remain unchanged. Option B requires high investments and considerable process changes but would also increase the robustness of the company. With options C and D, the company would risk not only the loss of revenue or penalty but also the loss of customers. With these variants, the company could be sacrificing its future profitability. However, if the demand for this product is declining already, it would be a viable risk. It becomes visible that the options need to be considered within the framework of business goals and the corporate environment of the company.

### 3 State of the Art

#### 3.1 Challenges

The use case reveals several challenges for performance management of business process variants. Firstly, as explained in the previous section, it becomes visible that the performance of business process variants cannot be directly compared to each other and the ideally designed process due to differences in **(C-1) goals, process sequences, and structure** as well as **framework conditions** (e.g. different quote-to-cash process execution by different organizations) [1]. Furthermore, **(C-2) some process variants may not have existed before**, because they are deviations from the ideal process and have therefore not been considered in the PMS. This challenge is intensified if the **(C-3) processes are strongly interrelated with each other** and are **hard to trace because they are not fully conducted with IT systems**. In the use case, the supply chain issue occurs suddenly and option B, which is a complex process variant due to its interrelations with manufacturing processes, has not been considered before as the company was not planning on investing in new equipment.

As each decision opens up a new branch of options and possible process chains, the involved process roles and stakeholders involved are different depending on the option. **Different stakeholders hold different views on process variants (C-4)** that were generated for different purposes [2]. For developing a PMS for the use case at hand, for instance, the involvement of the legal team needs to be considered, especially when evaluating the performance of Option D. Therefore, the interest is required to be balanced between stakeholders because they embrace different objectives [7]. Lastly, as described in Sect. 1, one major reason for the occurrence of process variants is the need for companies to quickly adapt to changes in the corporate environment [12]. It is **resource- and time-consuming (C-5)** to monitor and control a large number of business process variants simultaneously [2]. Furthermore, for making an informed decision for one of the four process options, **a quantitative prognosis for each of the options (C-6)** is needed.

#### 3.2 Existing PMS Approaches and Requirements Development

PMS can be classified into three categories: traditional, framework-based, and technology-based approaches [9]. This work focuses on analyzing framework-based PMS because the framework-based PMS enables companies to derive an individual PMS according to their business strategy [9]. Balanced Scorecard (BSC), Performance Pyramid, and Performance Prism are the three main framework-based approaches for performance management [13].

KRAUSE [9] developed requirements for PMS by deriving them from an empirical study on the success of existing PMS approaches and assigned the requirements to four clusters: The general PMS concept, the knowledge base and procedure model for developing a PMS, and the software support for PMS implementation. In his work, the feedback and feedforward principle of business processes in the sense of a closed loop is considered. Furthermore, in contrast to previous approaches, KRAUSE takes a

process-oriented perspective in a way that the PMS covers the entire value chain process. However, as mentioned in Sect. 1, unforeseen process variants are not considered in his work. The stakeholder benefit-oriented and business process-based method was developed based on the assumption that all processes run according to plan.

## 4 Requirements for PMS with Consideration of Process Variants

### 4.1 Development Approach

The overall steps for requirements development are summarized in Fig. 1. Firstly, the research group conducted the serious game, identified the relevant challenges and conducted a literature review to analyze existing requirements. Based on the work of KRAUSE [9], the gap between the challenges (Sect. 3.1) and existing requirements by KRAUSE (Sect. 3.2) was analyzed. The results of the analysis are summarized and elaborated in Sect. 4.2. Next, based on the use case, the gap in requirements was derived from this analysis, and additional requirements as well as adjustments to existing requirements were proposed. Thereby, the adjusted requirements list was specified with consideration of process variants. In Sect. 4.3, an excerpt of the specified requirements is elaborated based on the use case.

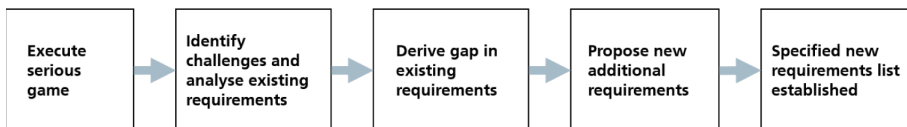


Fig. 1. Steps for requirements development

### 4.2 Relation of Existing Requirements and the Challenges

The degree of how much existing requirements by KRAUSE [9] addresses the named challenges is summarized in Table 2. The gap analysis is explained below the table using the first cluster as an example.

The first cluster consists of three requirements. According to KRAUSE, a PMS needs to take a holistic approach in the way that it must include four components (A1–1): critical success factors, business processes, performance improvement projects, and performance indicators. Hence, the need to consider the differences in goals and framework conditions of process variants (C-1) is partially covered by this requirement. If a PMS is developed for the use case under this requirement, the PMS would take the critical success factors ‘implementation time’ and ‘implementation cost’ into account when comparing the performance of, for example, Option A and Option B.

The second requirement defines that the PMS needs to be integrated into the organization-specific management systems (e.g. existing risk management system) (A1–2). This enables the performance management of interrelated processes (C-3) which are



**Table 2.** Gap analysis between existing requirements by KRAUSE [9] and the challenges associated with the performance management of process variants.

Existing requirements by KRAUSE		Challenges associated with process variants					
		C-1	C-2	C-3	C-4	C-5	C-6
Overall concept							
A1-1	Holistic approach						
A1-2	Integration of results						
A1-3	Openness						
Knowledge basis							
A2-1	Map the content and structure of existing PMS						
A2-2	Map the existing tech and templates						
A2-3	Indicator category						
A2-4	Reference model						
Process model							
A3-1	Create task-specific PMS						
A3-2	Method for creating as-is and to-be profile						
A3-3	Transparent cause-effect network						
A3-4	Definition of business process based on indicator						
A3-5	Indicator data model						
A3-6	Create a tetrahedral structure for PMS						
A3-7	Integrate user participation through the counter-current principle						
Software support							
A4-1	Secure the experience						
A4-2	Use of knowledge						
A4-3	Construction of new PMS						
A4-4	The adjustment from PMS-Content and structure						
A4-5	Analysis of PMS-Content and -structure						
A4-6	Illustration of the value chain						
Legend:  Addresses fully  Addresses partially  Does not address							

conducted by different roles with different stakeholders (C-4). In use case scenario, Option C is risky in terms of losing customers.










By the integration of new aspects including new technologies and instruments, as proposed by the third requirement (A1–3), new process variants can also be included (C-2). However, the requirements in the cluster ‘overall concept’ (A1–1, A1–2, A1–3) do not address the issue of high resource consumption of process monitoring (C-5) and the need for predictive prognosis (C-6).

In summary, the challenges (C-1), (C-2), (C-3), (C-4) and (C-5) are largely addressed by the requirements developed by KRAUSE. However, the predictive prognosis challenge (C-6) is only partially covered by requirement (A3–2), which points out that the as-is and to-be model should be studied, but lacks the instructions of conducting predictive prognosis.

### 4.3 Excerpt of Specified Requirements

Next, based on the gap analysis, the set of generic requirements by KRAUSE [9] were specified for the performance management of process variants. The specification was done by adjusting the generic requirements and by adding new requirements in order to create a set of requirements that fully address the named challenges. In this paper, the specification is demonstrated with one example ('Benefit potential' (A4–7)) of a newly proposed requirement, which is shown in Table 3 and explained in the following.

**Table 3.** Evaluation of the newly proposed requirement

Newly proposed requirements		Challenges associated with process variants					
		C-1	C-2	C-3	C-4	C-5	C-6
A4-7	Benefit potential						
Legend:		 Addresses fully	 Addresses partially	 Does not address			

The gap analysis revealed that challenge (C-6) is not covered by the existing set of requirements. Therefore, one new requirement, which addresses the need for predictive prognosis had to be integrated into the set. In the use case, for example, Option A not only increases the cost of production but also brings no direct benefit to the future of the organization. On the other hand, Option B can enhance organizational resilience to mitigate future disruptions but comes with much higher investments at present. Hence, predictions of not only the estimated profit but also intangible benefits to the organization have to be made in order to make an informed decision for one of the process variants. For instance, return of investment and technology capabilities for each option should be evaluated respectively. Additionally, the benefit potential needs to be clarified, based on the value chain of the organization. By fulfilling this requirement, the relevant interests of different (C-4) stakeholders can be considered as well.

## 5 Summary and Outlook

The challenges associated with process variants were analyzed based on a serious game as the use case. An overview of previous research on process-oriented development of PMS is given. Building on the work of KRAUSE, the requirements for the development of a PMS were further developed in order to overcome the named challenges. The specification and evaluation of the requirements is demonstrated with one requirement in this paper. It was newly added to the set of requirements in order to address the challenge concerning the need for predictive prognoses.

Further steps of the research at hand is the development of a PMS for the use case based on the specified requirements. Afterwards, the PMS will be implemented in the serious game. The last step is the validation of the implemented PMS and of the underlying specified requirements. Finally, the serious game provides a training environment for researchers and for managers in the industry for ad-hoc problem solving.

## References

1. Taymouri, F., La Rosa, M., Dumas, M., Maggi, F.M.: Business process variant analysis: survey and classification. *Knowl.-Based Syst.* **211**, 106557 (2021)
2. Rosing, M.V., Erasmus, J.: Variation in business processes. In: *The Complete Business Process Handbook*, vol. 1, pp. 455–474. Elsevier (2015)
3. Torka, J., Lange, A., Scholz, J., Knothe, T., Busse, D.: Model-based process generation for supporting agile shop floor management in SMEs. In: *CPSL 2021*, pp. 546–556, publish-Ing, Hannover (2021)
4. Lerner, B.S., Christov, S.: Exception handling patterns for process modeling. *IEEE Trans. Softw. Eng.* **36**, 162–183 (2010)
5. Price, A.M., Kim, C.J., Burkholder, E.W., Fritz, A.V.: A Detailed characterization of the expert problem-solving process in science and engineering: guidance for teaching and assessment. *CBE Life Sci. Educ.* **20**, 1–15 (2021)
6. Owen, D.: Lessons for Business Resilience Planning. *Risk Management*, 16–17 (2021)
7. Dumas, M., Rosa, M.L., Mendling, J., Reijers, H.A.: *Fundamentals of business process management*. In: *Fundamentals of Business Process Management*. Springer, Berlin (2018). [https://doi.org/10.1007/978-3-662-56509-4\\_1](https://doi.org/10.1007/978-3-662-56509-4_1)
8. Moynihan, D.P.: *The Dynamics of Performance Management: Constructing Information and Reform*. Georgetown University Press, Washington (2008)
9. Krause, O., Mertins, K.: *Performance Management. Eine Stakeholder-Nutzen-orientierte und Geschäftsprozess-basierte Methode*. Deutscher Universitätsverlag Wiesbaden (2006). <https://doi.org/10.1007/978-3-8350-9191-7>
10. Rumeser, D., Emsley, M.: Can serious games improve project management decision making under complexity. *Project Manag. J.* **50**, 23–39 (2019)
11. Tangen, S.: Performance measurement: from philosophy to practice. *Int. J. Product. Perform. Manag.* **53**, 726–737 (2004)
12. Bolt, A., van der Aalst, W.M.P., de Leoni, M.: Finding process variants in event logs. In: *On the Move to Meaningful Internet Systems. OTM 2017 Conferences. OTM 2017. Lecture Notes in Computer Science*, vol. 10573, pp. 45–52. Springer, Cham (2017). [https://doi.org/10.1007/978-3-319-69462-7\\_4](https://doi.org/10.1007/978-3-319-69462-7_4)
13. Kaplan, R.S., Norton, D.P.: The Balanced Scorecard-Measure that Drive Performance. *Harvard Business Review*, New York, pp. 71–79 (1992)

**Open Access** This chapter is licensed under the terms of the Creative Commons Attribution 4.0 International License (<http://creativecommons.org/licenses/by/4.0/>), which permits use, sharing, adaptation, distribution and reproduction in any medium or format, as long as you give appropriate credit to the original author(s) and the source, provide a link to the Creative Commons license and indicate if changes were made.

The images or other third party material in this chapter are included in the chapter's Creative Commons license, unless indicated otherwise in a credit line to the material. If material is not included in the chapter's Creative Commons license and your intended use is not permitted by statutory regulation or exceeds the permitted use, you will need to obtain permission directly from the copyright holder.





# **Correction to: Resource-Efficient Process Chains for the Production of High-Performance Powertrain Components in the Automotive Industry**

Berend Denkena, Benjamin Bergmann, Marcel Wichmann, Miriam Handrup, Daniel Katzsch, Philipp Pillkahn, Leon Reuter, Christopher Schmidt, and Frederik Stelljes

**Correction to:**  
**Chapter “Resource-Efficient Process Chains for the Production of High-Performance Powertrain Components in the Automotive Industry” in: H. Kohl et al. (Eds.): *Manufacturing Driving Circular Economy*, LNME, [https://doi.org/10.1007/978-3-031-28839-5\\_46](https://doi.org/10.1007/978-3-031-28839-5_46)**

In the original version of the book, a citation was added to the legend of figure 2, and the corresponding reference was added in the reference list in Chapter 46. Moreover, an explaining sentence was added and a typo was corrected in the body text referred to this figure. The book has been updated with the changes.

---

The updated original version of this chapter can be found at [https://doi.org/10.1007/978-3-031-28839-5\\_46](https://doi.org/10.1007/978-3-031-28839-5_46)

© The Author(s) 2023  
H. Kohl et al. (Eds.): GCSM 2022, LNME, p. C1, 2023.  
[https://doi.org/10.1007/978-3-031-28839-5\\_122](https://doi.org/10.1007/978-3-031-28839-5_122)

# Author Index

## A

Ackermann, Thomas 585  
Adil, Gajendra Kumar 990  
Adjei, Frederick 1027  
Afy-Shararah, Mohamed 375  
Aigbodion, V. S. 1037  
Aigbodion, Victor Sunday 266  
Alammari, Y. 193  
Amir, Saman 111  
Anderl, Reiner 559, 721, 749  
Anokye, Arnold 1027  
Appiah, Jorge 1027  
Arnemann, Lars 721, 749  
Asensio, T. 1065  
Asif, Farazee M. A. 953  
Atia-Abugbilla, Isaac 1027  
Ay, Sila 1091  
Ayetor, Godwin 1027  
Ayomoh, Michael 211  
Azaria, U. 184

## B

Bachlechner, Daniel 60  
Badurdeen, F. 1065  
Badurdeen, Fazleena 401, 799, 1082  
Bähre, Dirk 819  
Barmbold, Boris 490  
Barth, Martin 440  
Bay, Christian 669  
Ben-Hanan, U. 184  
Berger, S. 193  
Bergmann, Benjamin 410  
Bergmann, M. 148  
Bergs, Thomas 685  
Berkhahn, Magda 981  
Biermann, D. 193  
Biermann, Lars 175  
Bleicher, Friedrich 508  
Bolech, Michael 901  
Braeutigam, Volker 551

## C

Cajner, Hrvoje 614  
Campana, G. 836, 1065  
Campana, Giampaolo 302  
Can, Alperen 499  
Caudill, Daniel 1082  
Chandrasiri, M. K. D. C. K. 1044  
Chapieski, Gabriela Aparecida 678  
Cimatti, B. 836, 1065  
Clark, Nikki 231  
Cooper, Clayton 845  
Cooper, Tim 757  
Copani, Giacomo 901

## D

Damek, Sebastian 551  
Daniyan, Ilesanmi 647  
De Bernardez, Leopoldo 302  
De Bortoli, L. 836  
de Francisco, Antonio Carlos 678  
Dean, Chelsea 401  
Decker, Steffen 551  
Denkena, Berend 410  
Dharmapriya, U. S. S. 1044  
Dharmawardhana, Mahanama 827  
Dissanayaka, Nuwan 827  
Dissanayake, Kanchana 970  
Dix, M. 148  
Dix, Martin 157  
Dlamini, Nokulunga Zamahlubi 854  
Döpfer, F. 166, 249  
Döpfer, Frank 111, 669  
Drossel, W.-G. 30  
Dück, Dominik 738  
Đukić, Goran 614

## E

Eckert, U. 184  
Eichert, Carsten 175  
Ekwaro-Osire, Henry 961  
El-Rahhal, Ali 499

Engert, Michelle 240  
 Ettrichrätz, M. 30

**F**

Fameso, Festus 647  
 Fatrias, Dicky 357  
 Ferrero, Vincenzo 419  
 Fickert, Axel 157  
 Franchino, Marco 659  
 Franco, Renan Louro Cardoso 175  
 Franke, Jörg 294, 440  
 Friedel, Andreas 285  
 Friedli, Thomas 945

**G**

Gal, Barna 60, 77  
 Gallina, Viola 60, 77  
 Gamesu, Martin 1082  
 Gao, Robert X. 845  
 Gebhardt, S. 30  
 Georgi, O. 30  
 Georgopoulos, Konstantinos 901  
 Gericke, Thore 472  
 Gißke, Carola 157  
 Glänzel, Janine 157  
 Gnauck, M. 30  
 Götze, Uwe 808  
 Gross, Daniel 139, 202  
 Grosse Erdmann, Julian 111  
 Gudukeya, Loice 729  
 Guedes, G. 1065  
 Gutu, Timothy 258  
 Gutwald, Benjamin 440

**H**

Haase, Louise Møller 757  
 Haase, Rico 51  
 Haddad, Yousef 712  
 Handrup, Miriam 410  
 Hanenkamp, Nico 12, 139, 202  
 Hanich, Ahmed Abu 862  
 Hapuwatte, Buddhika M. 419, 799  
 Hartley, Avery 1082  
 Hasan, Afif Akel 862  
 Hatton, Fiona L. 231  
 Hegab, Hussien 364  
 Hegedić, Miro 614  
 Heiland, Jasper 431  
 Heinzl, Carsten 3

Hermeling, Christian 51  
 Herrig, Tim 685  
 Hoffmann, Christoph 449  
 Hoyer, Stefan 273

**I**

Iglauer, Martin 910  
 Ihlenfeldt, Steffen 918  
 Ijuin, Hiromasa 103, 119, 127, 328  
 Ilie-Zudor, Elisabeth 60  
 Ingemarsdotter, Emilia 703  
 Ioshchikhes, Borys 431  
 Iovkov, I. 193  
 Ishigaki, Aya 119  
 Iyer, Rishabh 1091

**J**

Jacobsen, Benjamin 464  
 Jagtap, Sandeep 375, 528, 712  
 Jawahir, I. S. 799, 1065  
 Jensen, Peter Byrial 757  
 Jolly, Mark 457  
 Ju, Shu 12  
 Jun, Yongsung 94  
 Junk, Stefan 285

**K**

Kaiser, Melina 872  
 Kämper, Tom-Li 630  
 Kanakana-Katumba, M. G. 604  
 Kanganga, Mufaro 729  
 Kataoka, Takayuki 349  
 Katiyo, Munashe 729  
 Katzsch, Daniel 410  
 Kaufmann, Michel 961  
 Kaupp, Tobias 383  
 Kawane, Ryuto 103  
 Keivanpour, Samira 339, 772  
 Khabipova, Aigul 892  
 Kies, Alexander D. 320, 585  
 Kirwin, Roan 21  
 Kishawy, Hossam A. 364  
 Klimant, Philipp 157  
 Kobayashi, H. 836  
 Kohl, H. 595  
 Koketsu, Jundai 119  
 Koller, Jan 111  
 Kramer, Kathrin Julia 85  
 Kräusel, Verena 481

Krauß, Jonathan 585  
 Kremer, Gerald 981  
 Krenz, Pascal 936  
 Kroll, Lothar 273  
 Krommes, Sandra 519, 883  
 Krüger, Jörg 499  
 Kruschke, Thomas 694  
 Kuehl, Alexander 294  
 Kulatunga, A. K. 1044  
 Kulatunga, Asela K. 827

**L**

Lachmayer, Roland 790  
 Lang, Sven-Erik 819  
 Lange, Annika 1074  
 Lange, Christopher 449  
 Langer, Vivien 808  
 Larder, Ryan 231  
 Larsen, Niels Peter Lamm 567  
 Last, Noah 419  
 Laursen, Linda Nhu 757  
 Lermer, Michael 139, 202  
 Lieder, Michael 953  
 Lindow, Kai 576, 694, 981  
 Lüicking, Charlotte 175  
 Lund, Rasmus Bæk 567

**M**

Makinde, Olasumbo 391, 622, 638  
 Makinde, Olusambo 854  
 Maladzi, R. W. 604  
 Markert, Julia 936  
 Markov, Larisa 481  
 Marsh, Phillipa 757  
 Mathur, Nehika 419  
 Matope, Stephen 542  
 Mattes, Alexander 472  
 Maurer, Oliver 819  
 Mbohwa, Charles 927  
 Meier, Trixi 139, 202  
 Mele, M. 836, 1065  
 Mele, Mattia 302  
 Melo, Gustavo 320  
 Mende, M. 184  
 Mihelič, Aleš 111  
 Miller, Eddi 383  
 Mishimar, Nozomu 781  
 Mitra, Sanchayan 990  
 Mitterfellner, Miriam 585

Möhring, Hans-Christian 240  
 Morris, K. C. 419  
 Moyo, Marvellous 1053  
 Mozgova, Iryna 790  
 Mpofo, Khumbulani 391, 622, 647, 854  
 Mügge, Janine 576  
 Müller, Magdalena S. 219  
 Müller, Sebastian 40  
 Münnich, Marc 918  
 Munyai, Thomas 638  
 Mur, Sebastian 302  
 Mushiri, Tawanda 258, 1053  
 Mutenhabundo, Winnie 258  
 Muvunzi, Rumbidzai 647

**N**

Nagao, Takaki 127, 328  
 Nagasawa, Keisuke 328  
 Nagel, Lukas 999  
 Nagengast, Niko 669  
 Nahar, Samsun 231  
 Nakajima, Ryosuke 103, 536  
 Nakakura, Yuta 536  
 Naumann, Christian 157  
 Ndjieni, Freddy Ngankam 440  
 Nesamvuni, Edgar 638  
 Neuber, Christian 669  
 Nishino, Mana 536  
 Nitsche, Benjamin 68, 630  
 Noorbhai, Habib 1053  
 Nyakudya, Ratidzo Yvonne 211

**O**

Öchsner, Richard 449  
 Oertwig, N. 595  
 Okorafor, J. 1065  
 Omer, Mohammed 872  
 Onu, Peter 927  
 OoNorasak, Kendra 401  
 Opetuk, Tihomir 614  
 Oshiro, Leandro Inagaki 678  
 Oyesola, M. O. 604  
 Ozor, P. A. 1037

**P**

Pagone, Emanuele 375, 712  
 Pal, Rudrajeet 970  
 Pallas, Georgios 703  
 Paluch, Stefanie 320

Panagiotopoulou, Vasiliki C. 311, 1008  
 Pande, Bhavya 990  
 Panesso, M. 30  
 Papacharalamopoulos, Alexios 1008  
 Paraskevopoulou, Aikaterini 311  
 Parker, Ryan 542  
 Parthey, Franziska 559  
 Paschetag, Mandy 175  
 Pedersen, Frederik Bredahl 567  
 Pelchen, Lucas 40  
 Penter, Lars 157  
 Piendl, Daniel 431  
 Pillkahn, Philipp 410  
 Poeche, Moritz 1074  
 Pradhan, Anup 927  
 Putri, Nilda Tri 357

## Q

Quernheim, Niklas 721, 749

## R

Rakurty, C. S. 21  
 Ramatsetse, Boitumelo 622, 854  
 Rangasamy, Nithin 21  
 Ratnayake, R. M. R. N. K. 1044  
 Rauch, Christiane 819  
 Rautenstrauch, Anja 481  
 Redlich, Tobias 872  
 Reitenspieß, Max 12  
 Reslan, Maya 419  
 Reuter, Leon 410  
 Riedelsheimer, Theresa 576, 694, 981  
 Rosemann, Daniel 790  
 Rosilius, Maximilian 551  
 Roth, David 585  
 Rückert, Patrick 892  
 Rüger, C. 30

## S

Saelzer, J. 193  
 Salehi, Niloufar 953  
 Salem, Amr 364  
 Salonitis, Konstantinos 375, 457, 528, 712  
 Salvador, Rodrigo 678  
 Sarfraz, Shoaib 457  
 Sarikaya, Erkut 738  
 Saubke, Dominik 936  
 Schleich, Benjamin 721, 749  
 Schleifenbaum, Johannes Henrich 320

Schlund, Sebastian 77  
 Schmidt, Alexander 294  
 Schmidt, Christopher 410  
 Schmidt, Hans-Werner 669  
 Schmidt, J. 166, 249  
 Schmidt, Matthias 85  
 Schmitt, Jan 383  
 Schmitt, Robert H. 910  
 Schmitz, Henrik 431  
 Scholl, Stephan 175  
 Scholz, Julia-Anne 1091  
 Schoop, Julius 1082  
 Schramm, N. 595  
 Schreiner, F. 166, 249  
 Schulz, Hendrik 499  
 Schwaiger, Clemens 508  
 Schwichtenberg, Nik 472  
 Seegrün, Anne 576  
 Selbmann, R. 148  
 Severengiz, Semih 1027  
 Seyfried, Stefan 999  
 Shafinejad, Parnia 901  
 Sian, Mala 231  
 Sihn, Wilfried 60  
 Simbolon, Santa Rosa Roberta 357  
 Singhania, Sahil 703  
 Sohnius, Felix 910  
 Somaskantha Iyer, Smirthya 827  
 Sørby, Knut 219  
 Sperling, Denise 1027  
 Stange, Maximilian 918  
 Stark, Rainer 981  
 Stavropoulos, Panagiotis 311, 1008  
 Steinbach, Tanja 559  
 Stelljes, Frederik 410  
 Steward, Joseph 757  
 Stoltenberg, Lisa 936  
 Straube, Frank 68, 630  
 Sugi, Masao 103  
 Sugiyama, Kohei 127  
 Sukdeo, Nita 729  
 Süße, Marian 918  
 Sydney, Eduardo Bittencourt 678  
 Szaller, Ádám 60, 77

## T

Tampe, Annika 808  
 Tasaka, Kazuyuki 127  
 Temizu, Kosuke 536  
 Teng, Yu-Min 1091



Tetteh, Michelle Grace 528  
Thiele, Gregor 499  
Thoben, Klaus-Dieter 961  
Thomsen, Volkmar 472  
Thorenz, B. 166, 249  
Thornton, E.-Lexus 1082  
Tomaschko, Florian 519, 883  
Tošanović, Nataša 614  
Tracht, Kirsten 892  
Trautner, Thomas 508  
Trenz, André 449  
Trimingham, Rhoda 231  
Trstenjak, Maja 614  
Tsunezawa, Masakuni 127

**V**

van der Walt, Gerhard 391  
van Erp, Tim 567, 1016  
Vashisht, Diksha 990  
Voigt, M. 166  
von Eitzen, Ingo 551

**W**

Wallbaum, T. 148  
Wang, P. 1065  
Wasala, W. M. C. B. 1044  
Weerakkody, W. A. P. 1044  
Weidmann, Markus 559  
Weigold, Matthias 431, 490, 738, 999  
Weiser, Ingo Felix 685  
Weiss, A. 184

Wendt, Jonas 490  
Wenkler, Eric 157  
Werkle, Kim Torben 240  
Werner, Markus 51  
Wertheim, R. 184  
Weyand, Astrid 490, 738  
Wichmann, Marcel 410  
Wilhelm, Markus 551  
Wilson, Garrath T. 231  
Winter, Sven 721, 749  
Wolff, Steffen 721  
Woolley, Elliot 231  
Wörner, Daniel 945  
Wulfsberg, Jens P. 872  
Wurst, Johanna 790

**Y**

Yamada, Shuho 103  
Yamada, Tetsuo 103, 119, 127, 328  
Yoo, Yungchul 94

**Z**

Zannoun, H. 1065  
Zarnitz, Simon 68, 630  
Zeferino, Emanuel Fernando 622  
Zhang, Jianjing 845  
Zhang, Kai 12  
Ziegler, Marco 294  
Zmich, Robert 3  
Zvandasara, Patson 258